



US00D803953S

(12) **United States Design Patent**
Wallace

(10) **Patent No.:** **US D803,953 S**
(45) **Date of Patent:** **** Nov. 28, 2017**

(54) **INFLATABLE BUILDING BLOCK
RECTANGLE**

(71) Applicant: **Ryan Christopher Wallace**, Huntington Beach, CA (US)

(72) Inventor: **Ryan Christopher Wallace**, Huntington Beach, CA (US)

(**) Term: **15 Years**

(21) Appl. No.: **29/547,891**

(22) Filed: **Dec. 8, 2015**

(51) **LOC (10) Cl.** **21-01**

(52) **U.S. Cl.**
USPC **D21/500**

(58) **Field of Classification Search**

USPC D21/333, 373, 386, 389, 404, 468, 470,
D21/471, 475, 484-505

CPC A63H 33/04; A63H 33/06; A63H 33/062;
A63H 33/08; A63H 33/088; A63F 9/12;
A63F 9/1224

See application file for complete search history.

(56) **References Cited**

U.S. PATENT DOCUMENTS

D336,320 S * 6/1993 Sher D21/499
D343,427 S * 1/1994 Sher 446/128

(Continued)

Primary Examiner — Cynthia M. Chin

(74) *Attorney, Agent, or Firm* — Entralta P.C.; Justin G. Sanders; Peter D. Weinstein

(57) **CLAIM**

The ornamental design for an inflatable building block rectangle, as shown and described.

DESCRIPTION

FIG. 1 is a perspective view showing a 1st embodiment of my new inflatable building block rectangle design; FIG. 2 is a front view thereof; FIG. 3 is a rear view thereof; FIG. 4 is a left side view thereof; FIG. 5 is a right side view thereof; FIG. 6 is a top view thereof; FIG. 7 is a bottom view thereof; FIG. 8 is a perspective view showing a 2nd embodiment of my new inflatable building block rectangle design; FIG. 9 is a front view thereof; FIG. 10 is a rear view thereof; FIG. 11 is a left side view thereof; FIG. 12 is a right side view thereof; FIG. 13 is a top view thereof; FIG. 14 is a bottom view thereof; FIG. 15 is a perspective view showing a 3rd embodiment of my new inflatable building block rectangle design; FIG. 16 is a front view thereof; FIG. 17 is a rear view thereof; FIG. 18 is a left side view thereof; FIG. 19 is a right side view thereof; FIG. 20 is a top view thereof; FIG. 21 is a bottom view thereof; FIG. 22 is a perspective view showing a 4th embodiment of my new inflatable building block rectangle design; FIG. 23 is a front view thereof; FIG. 24 is a rear view thereof; FIG. 25 is a left side view thereof; FIG. 26 is a right side view thereof; FIG. 27 is a top view thereof; and, FIG. 28 is a bottom view thereof.

The broken lines shown are included for the purpose of illustrating portions of the article which form no part of the claimed design.

1 Claim, 16 Drawing Sheets

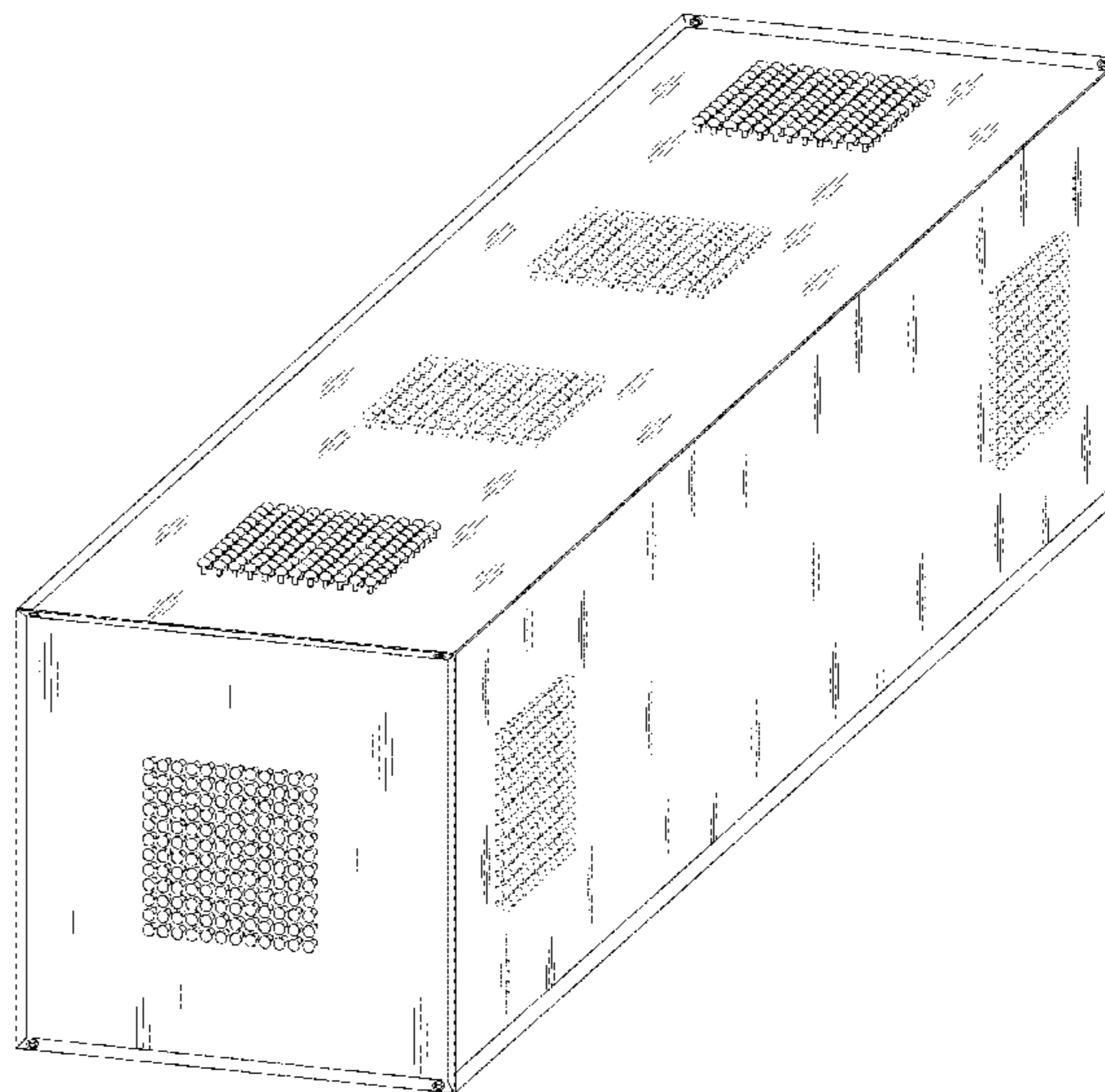
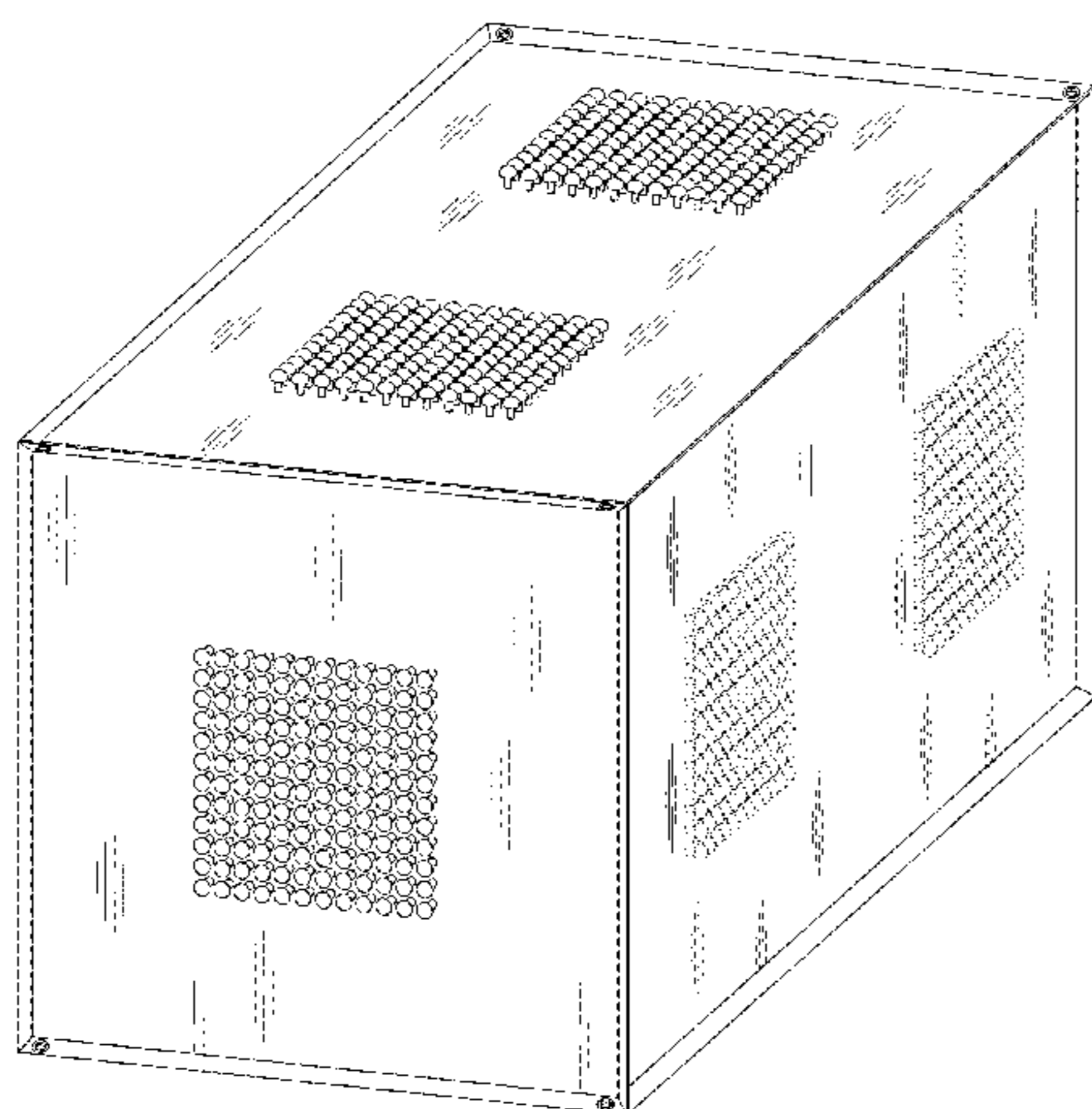

(56)

References Cited

U.S. PATENT DOCUMENTS

D351,425 S * 10/1994 Seiler D21/337
D359,315 S * 6/1995 Tacey D21/499
7,507,136 B2 * 3/2009 Patton A63H 33/046
335/285
D610,212 S * 2/2010 Pedersen D21/499
D630,685 S * 1/2011 Bodin D21/499
D698,869 S * 2/2014 Strzelewicz D21/499
D702,774 S * 4/2014 Wizenberg D21/499
D741,414 S * 10/2015 Lu D21/499
D754,263 S * 4/2016 Wolff D21/499
2009/0298382 A1 * 12/2009 Ochi A63H 33/086
446/121
2012/0122059 A1 * 5/2012 Schweikardt A63H 33/04
434/118

* cited by examiner

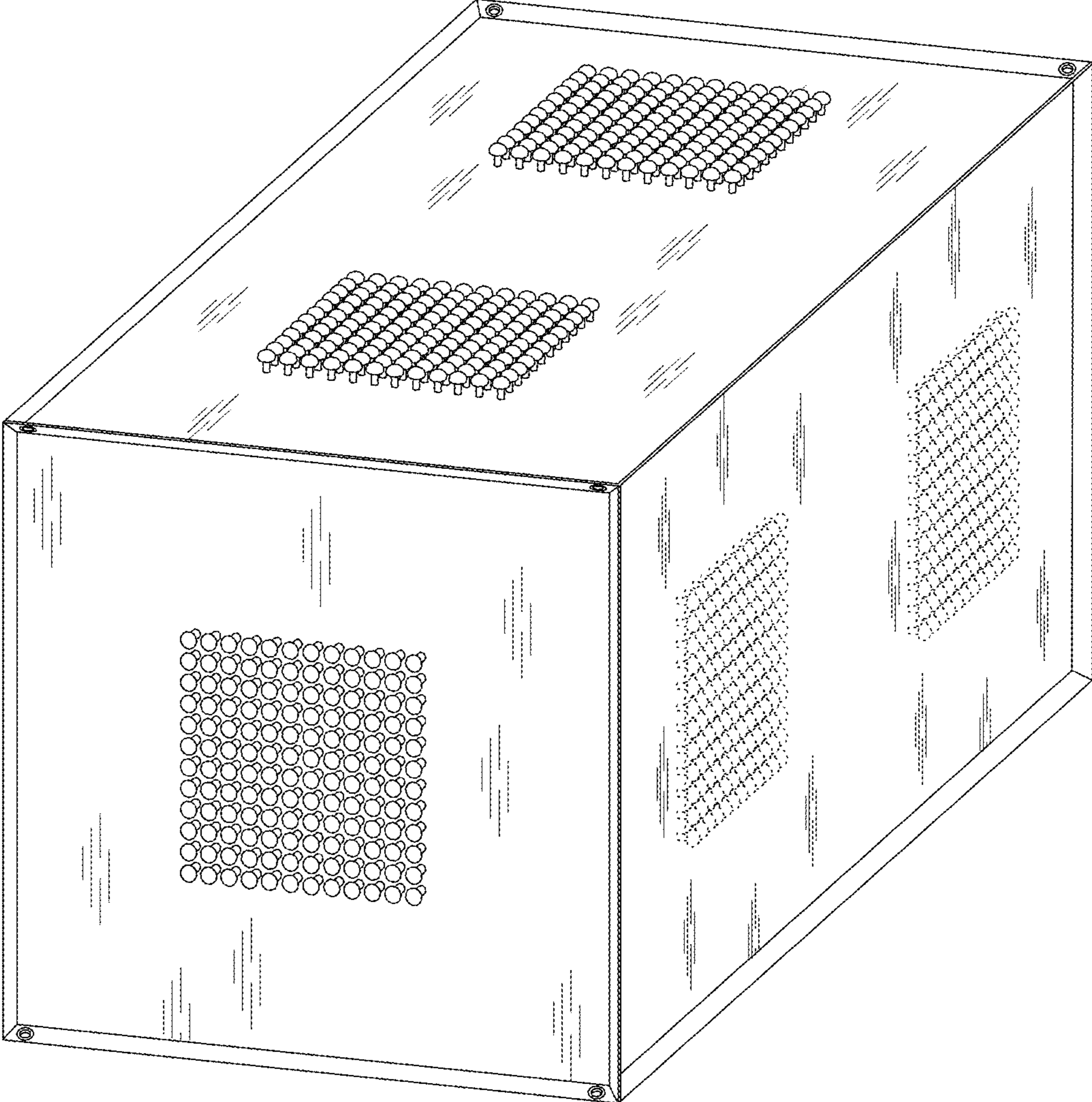

Fig. 1

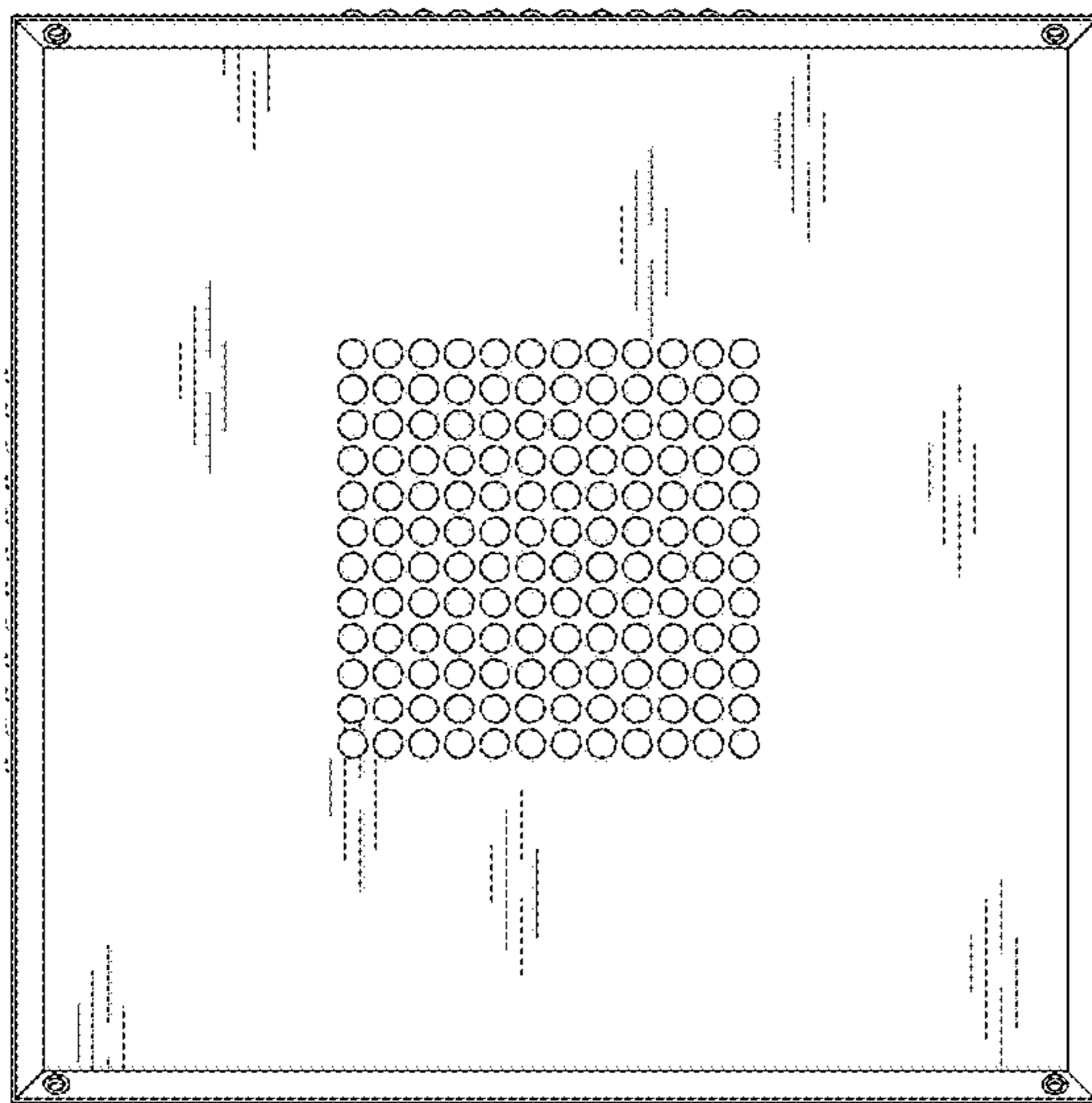

Fig. 2

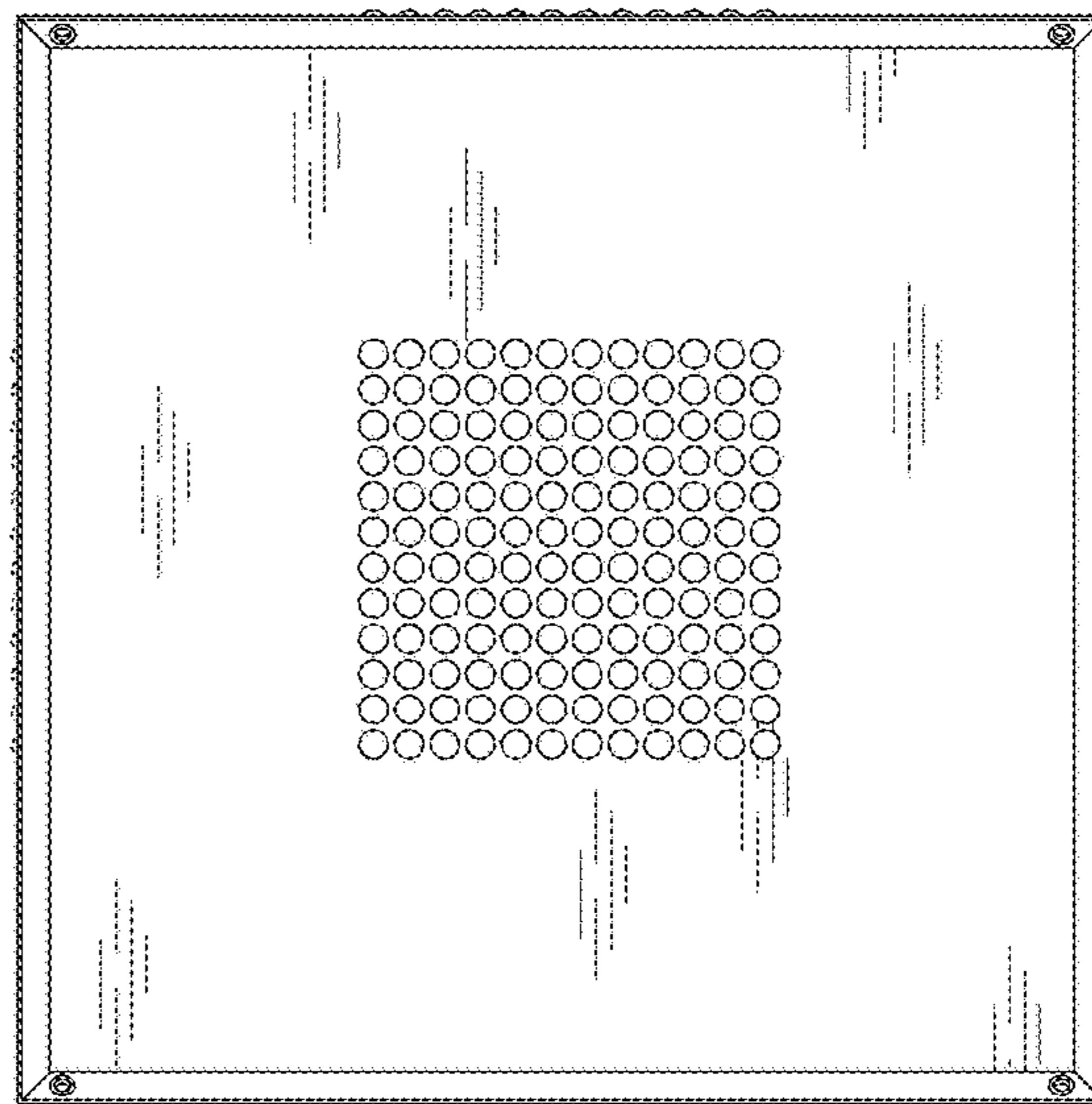

Fig. 3

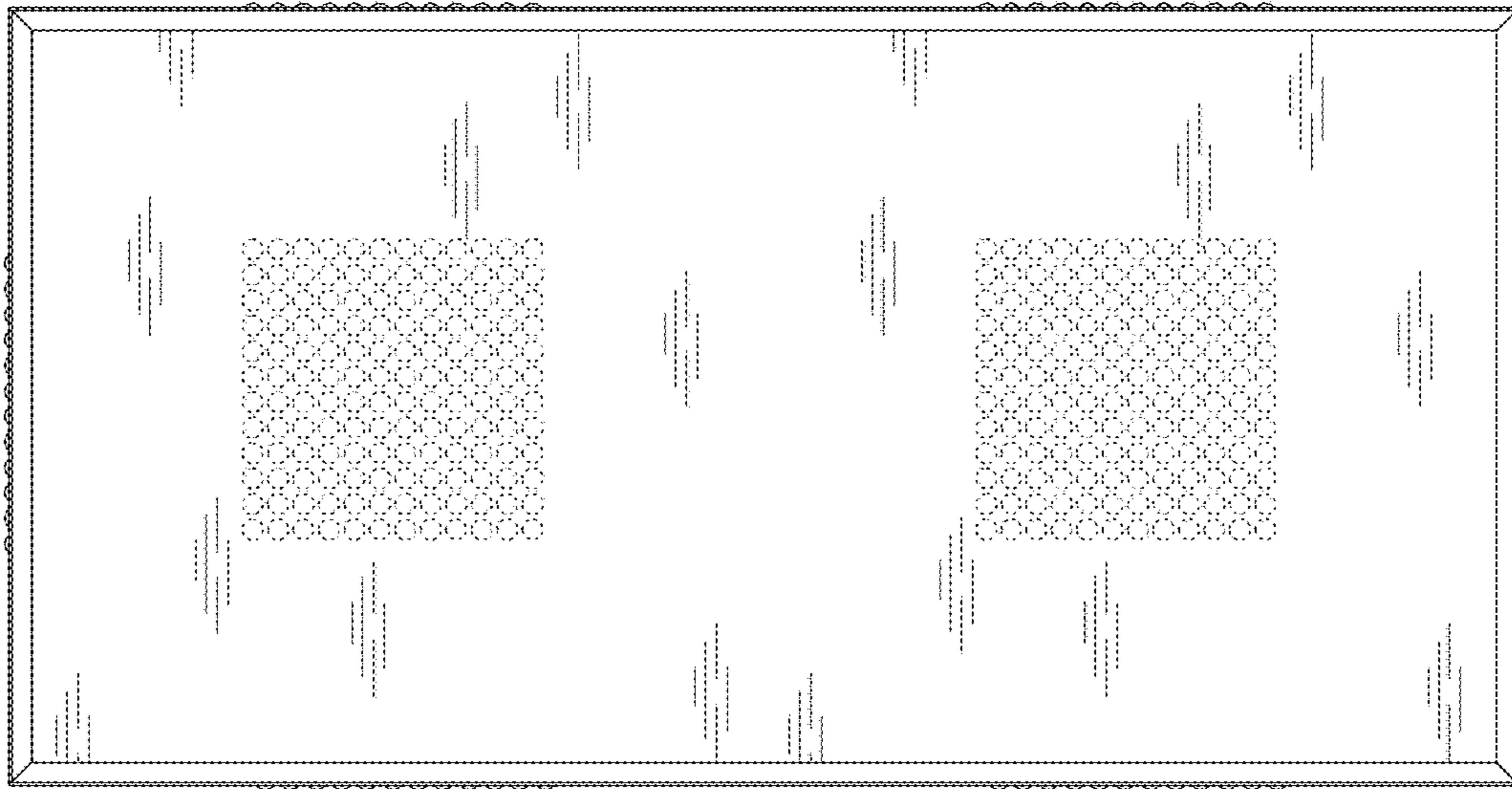

Fig. 4

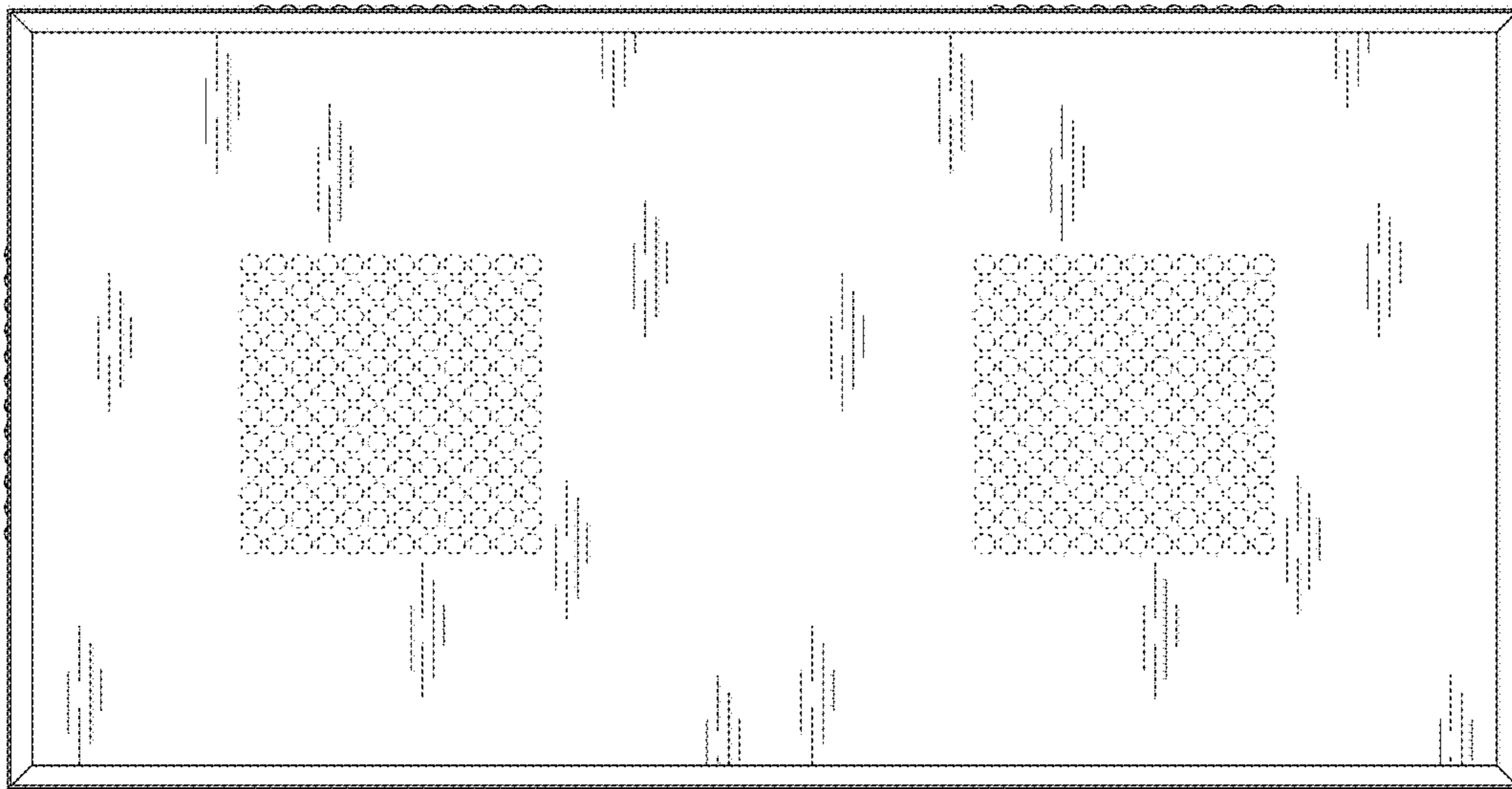

Fig. 5

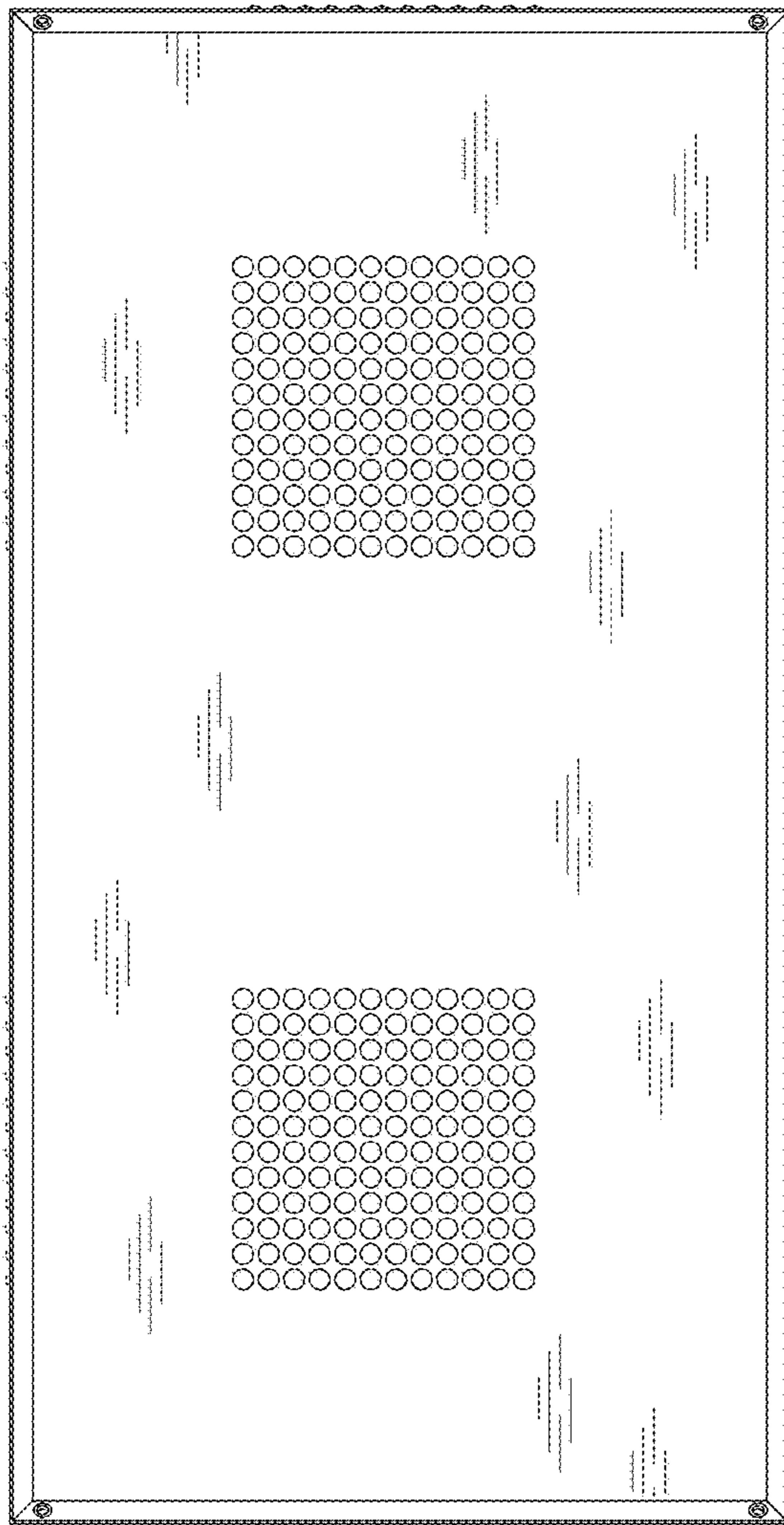

Fig. 6

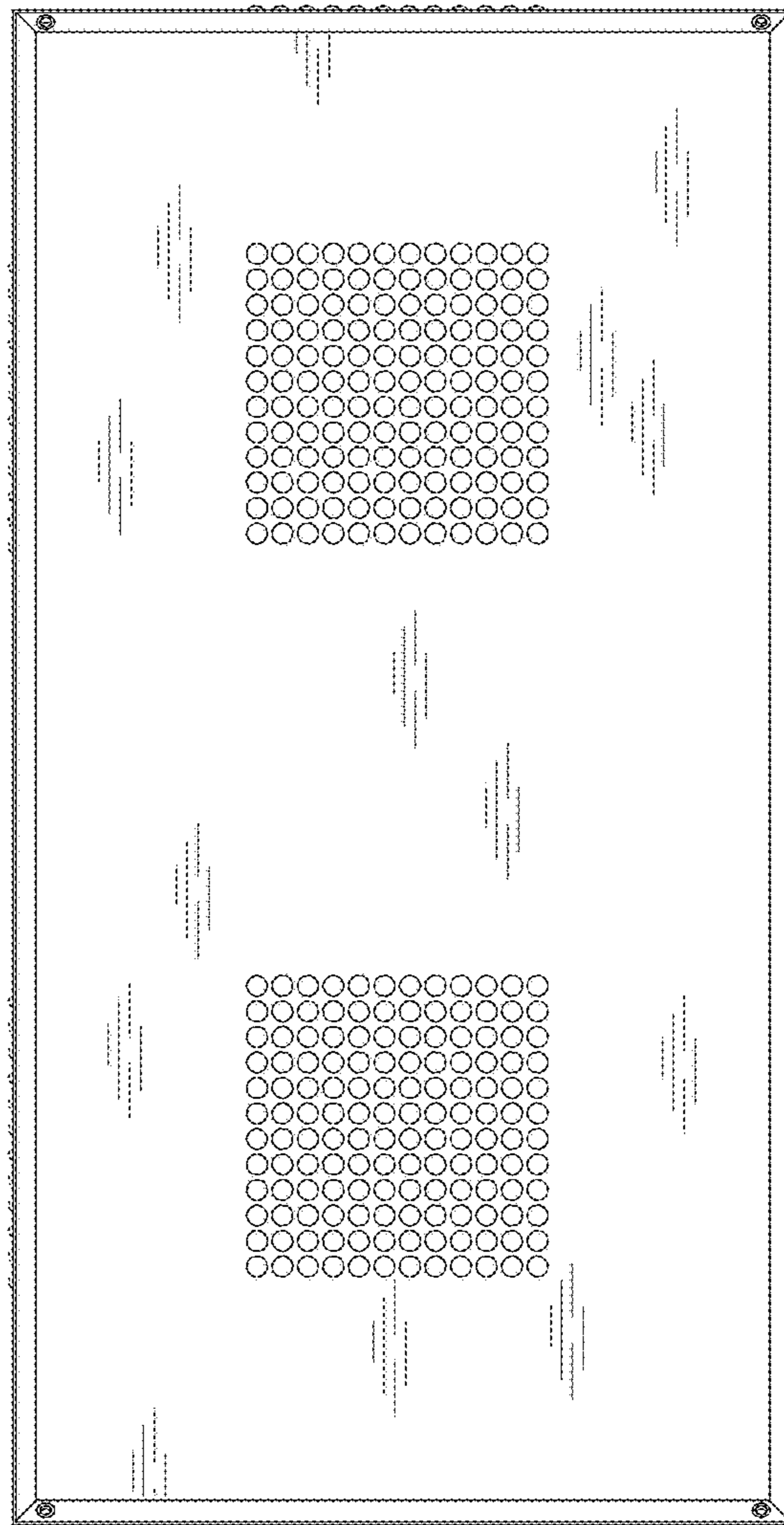

Fig. 7

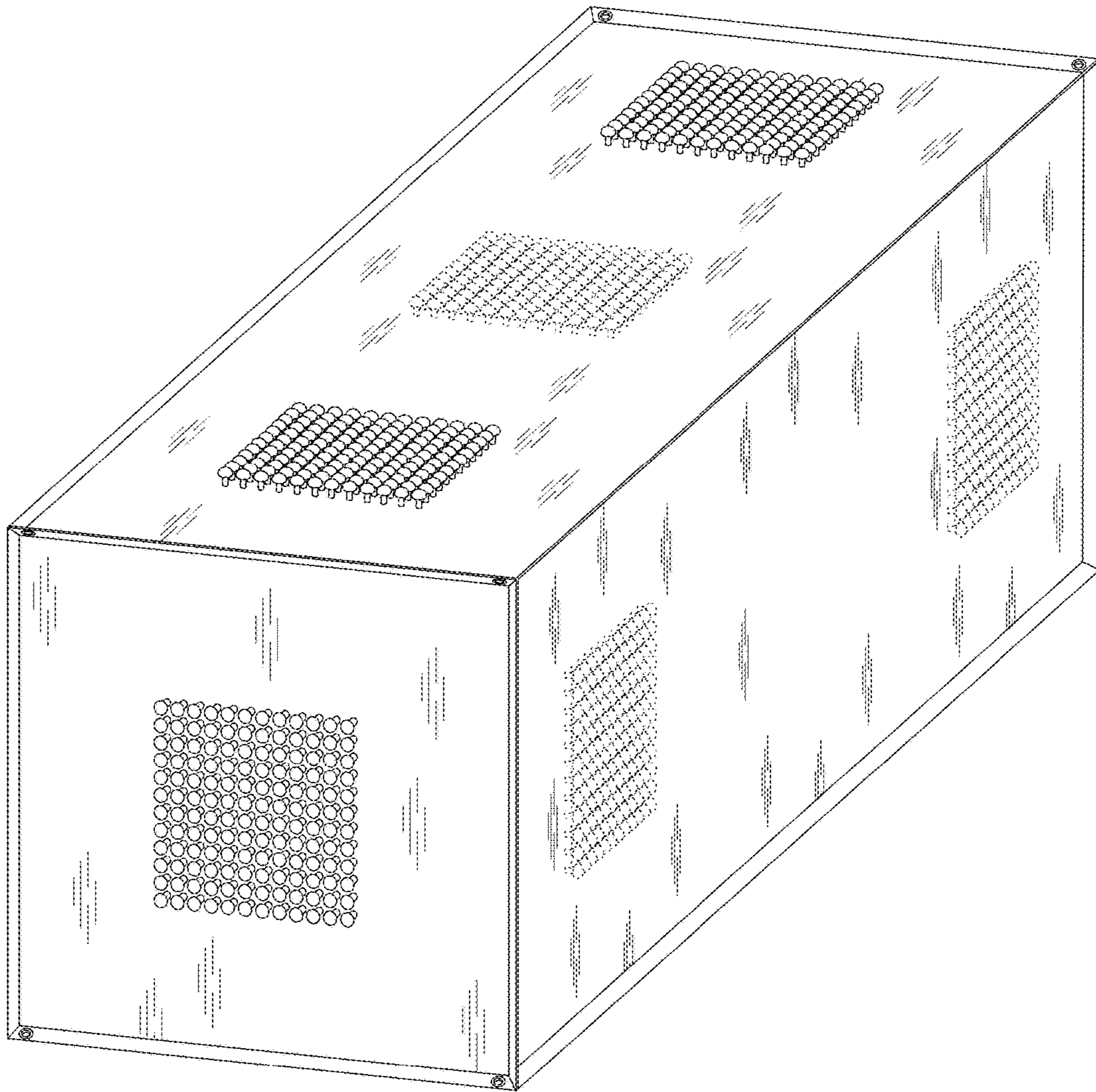

Fig. 8

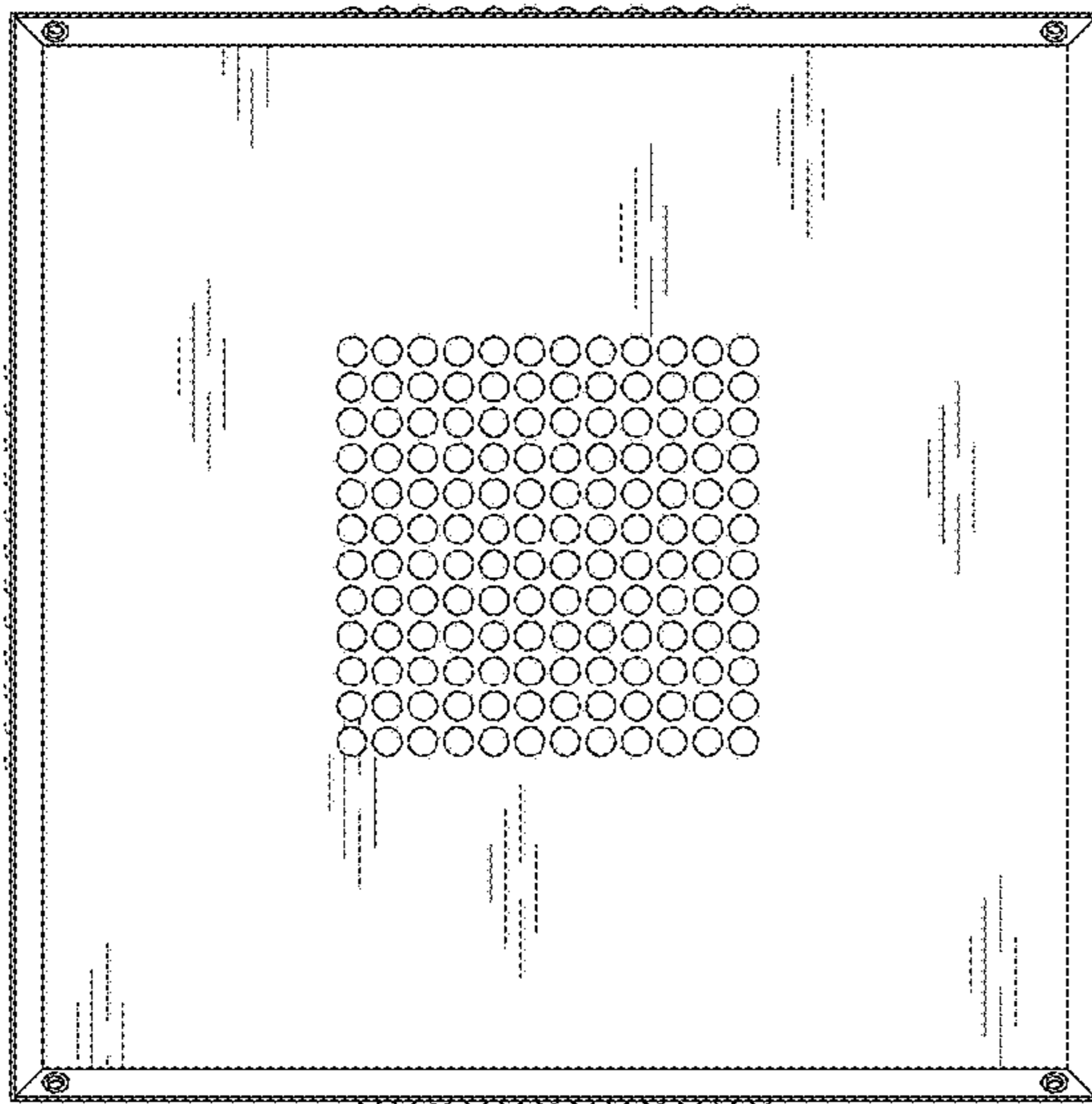

Fig. 9

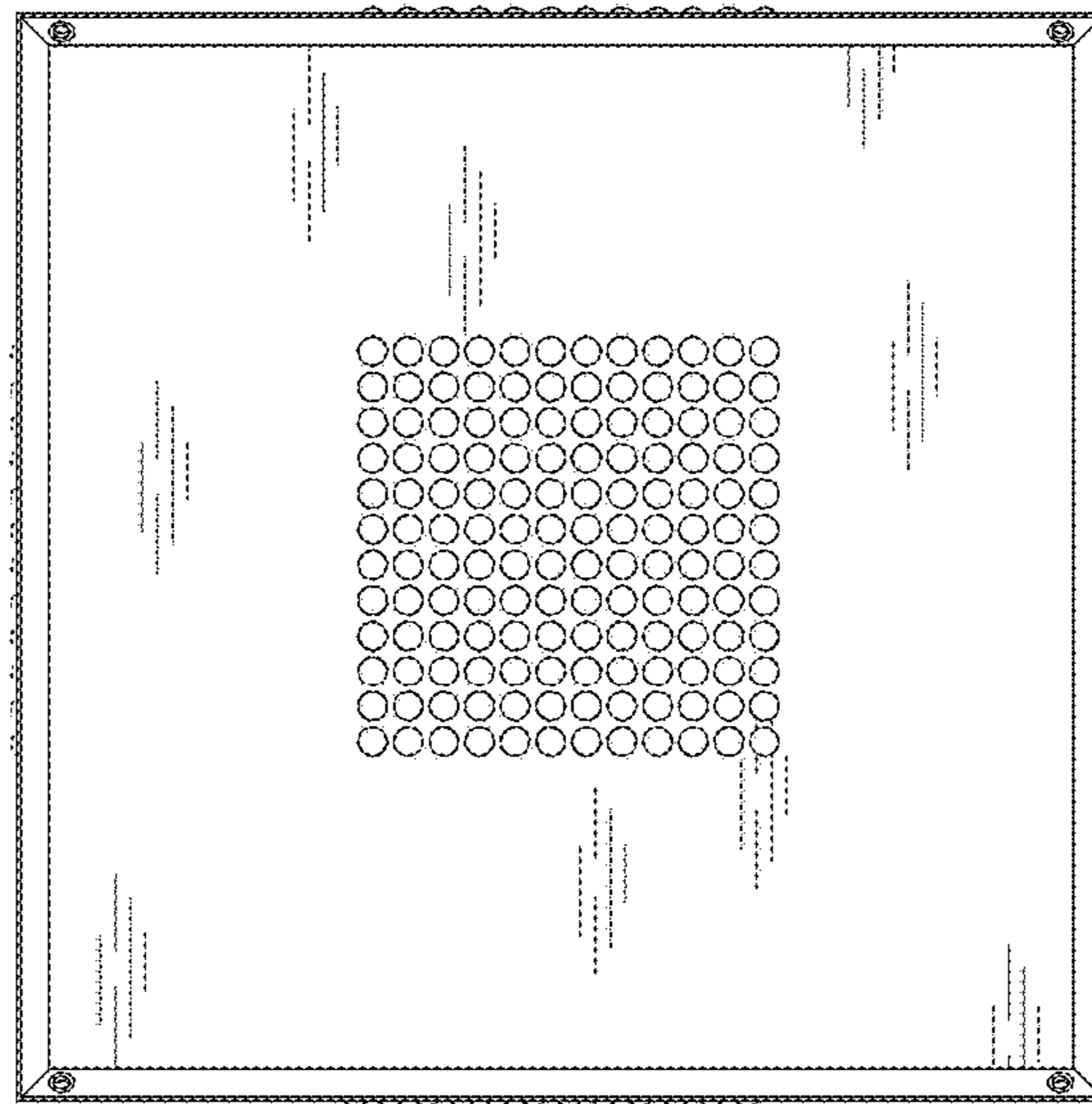

Fig. 10

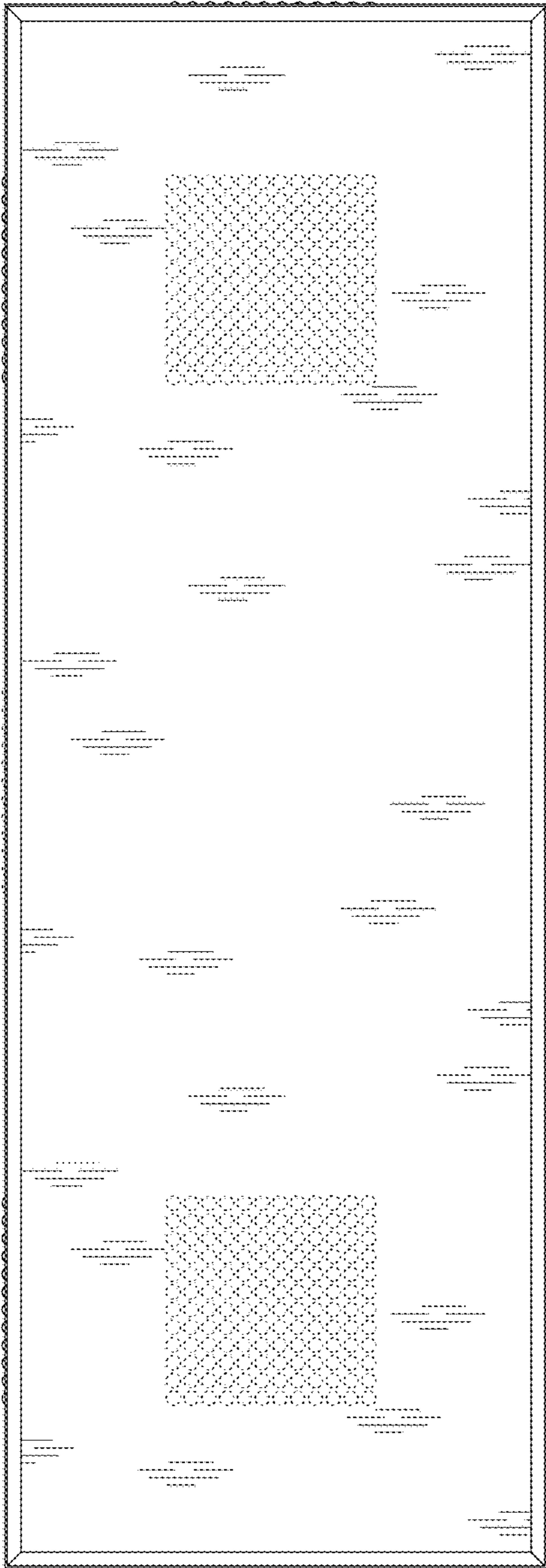

Fig. 11

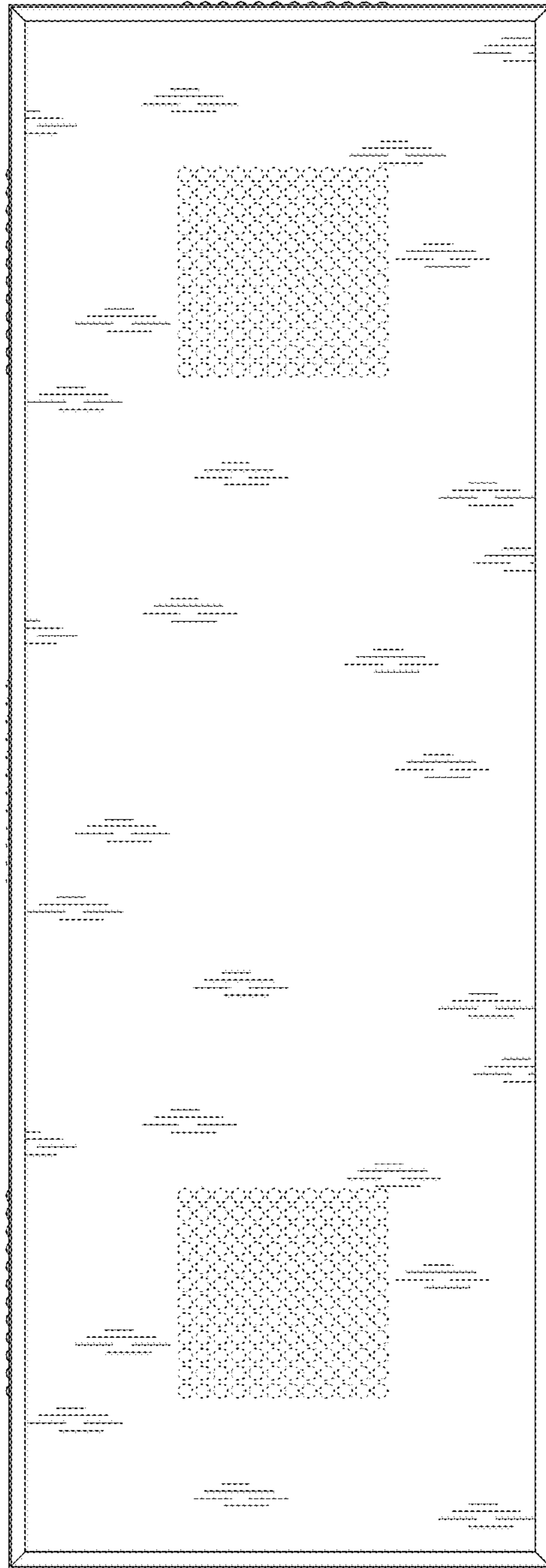

Fig. 12

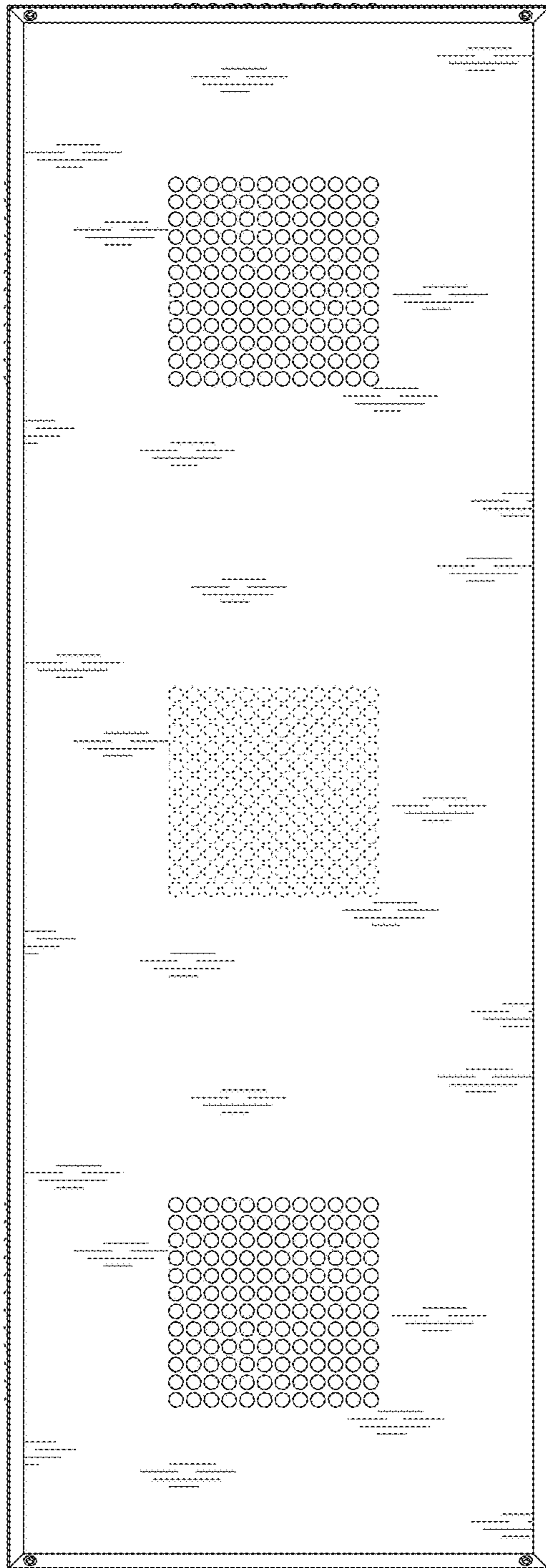

Fig. 13

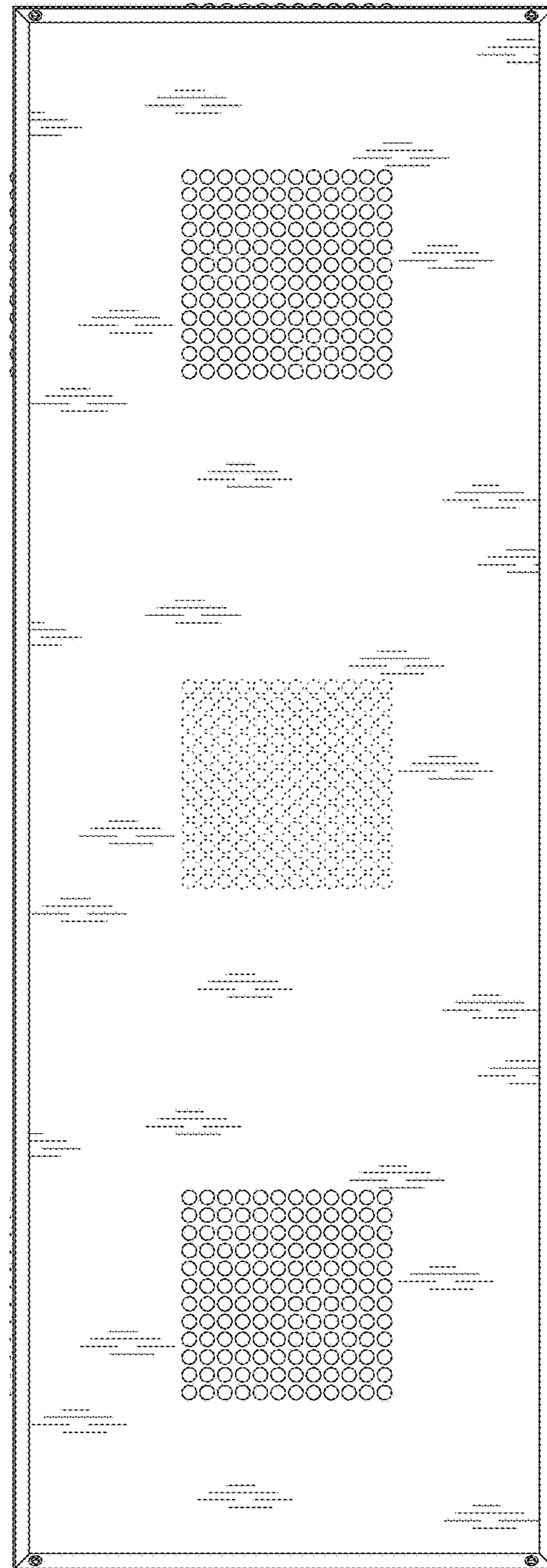

Fig. 14

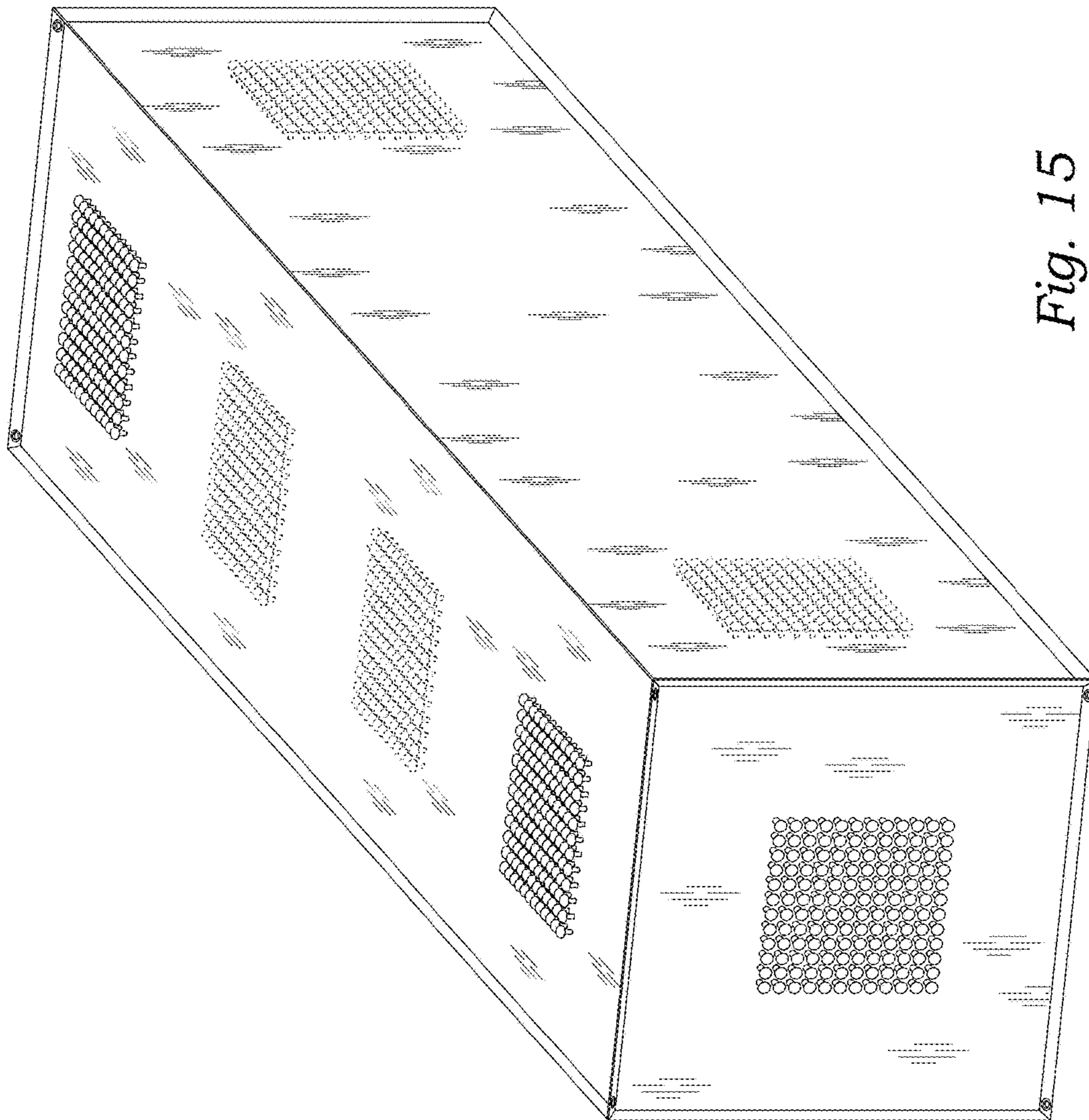

Fig. 15

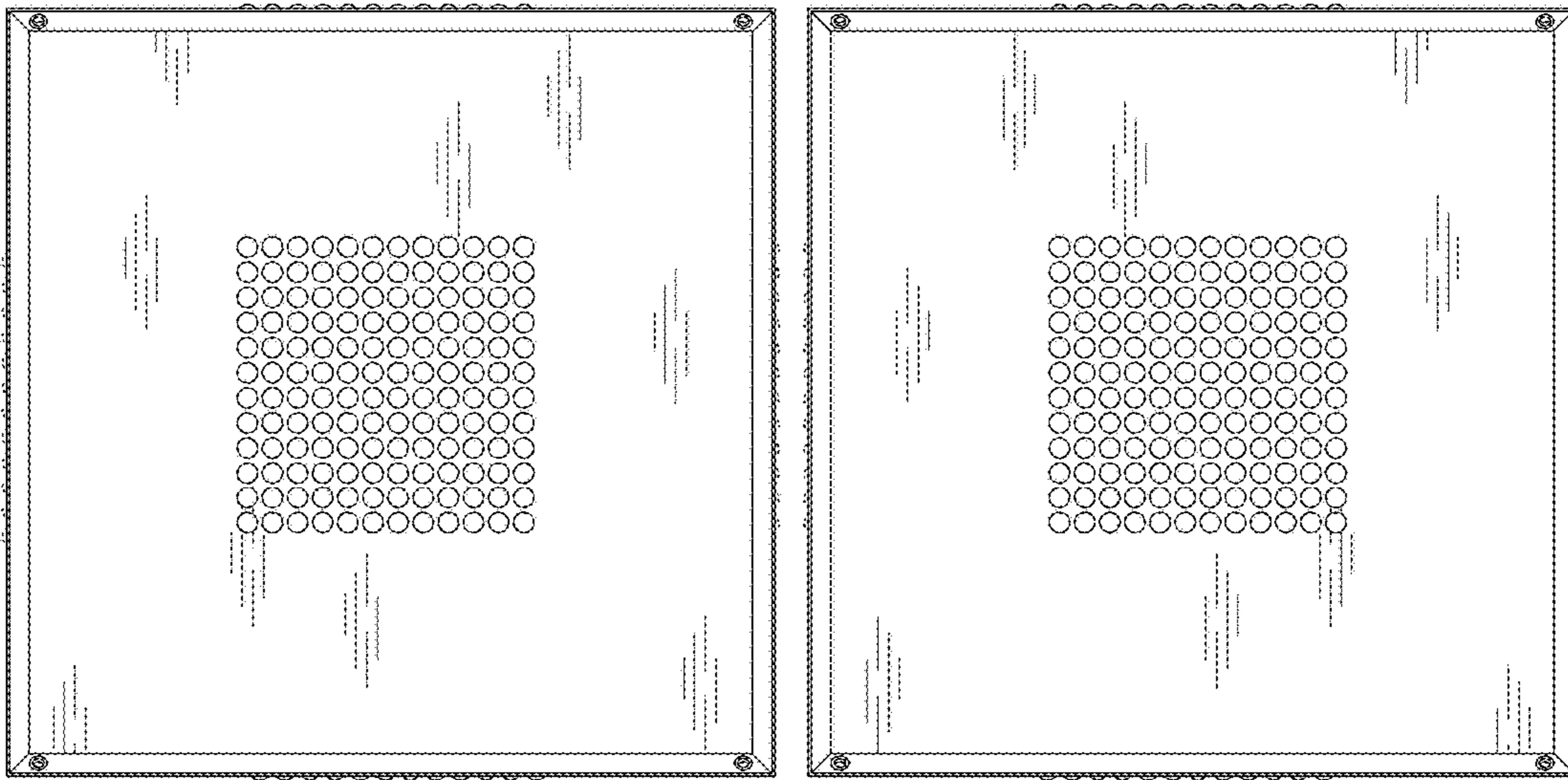

Fig. 16

Fig. 17

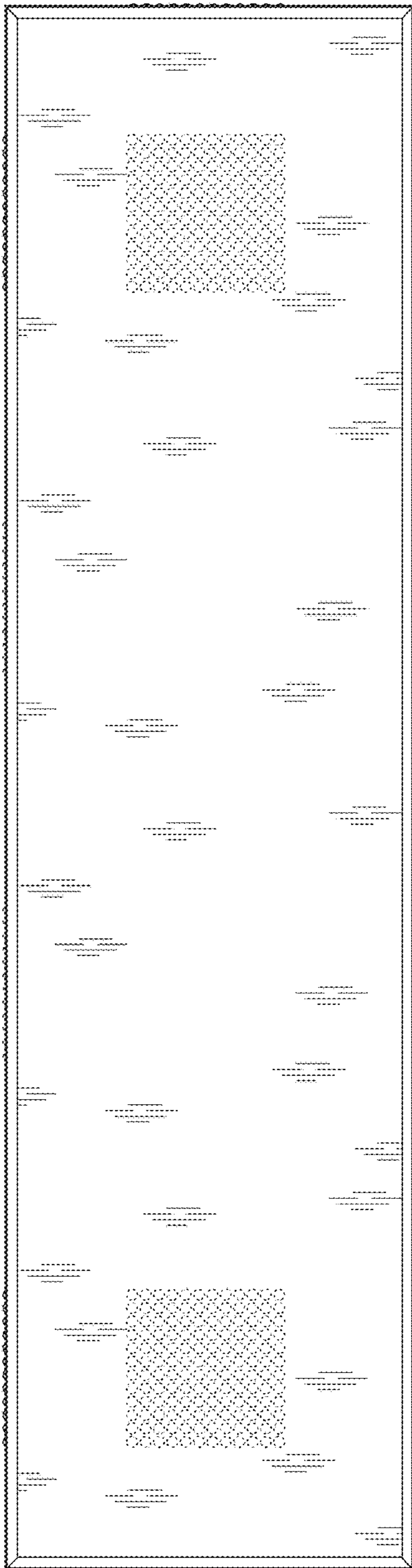

Fig. 18

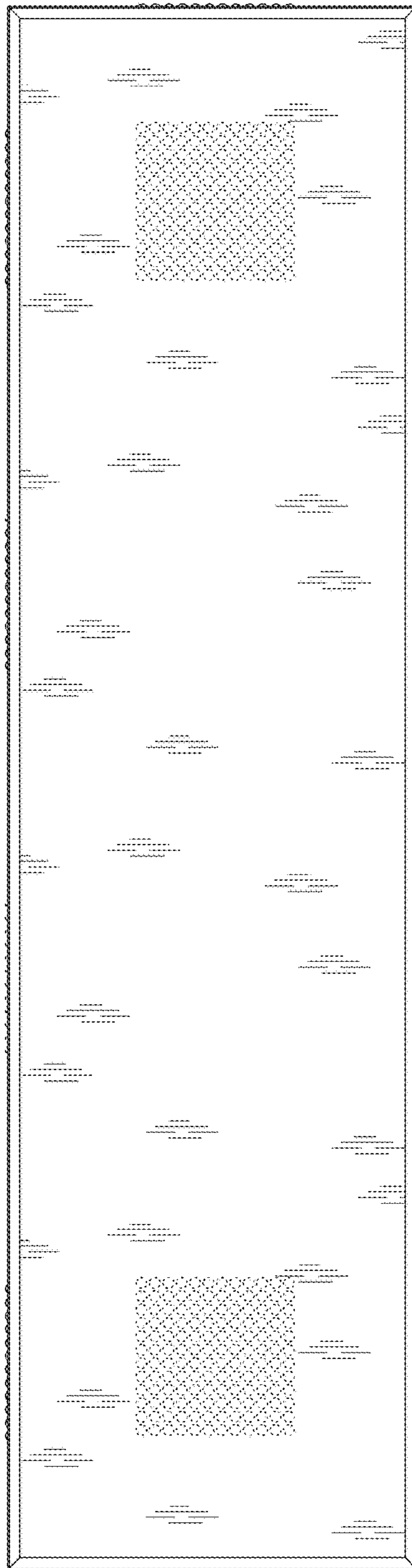

Fig. 19

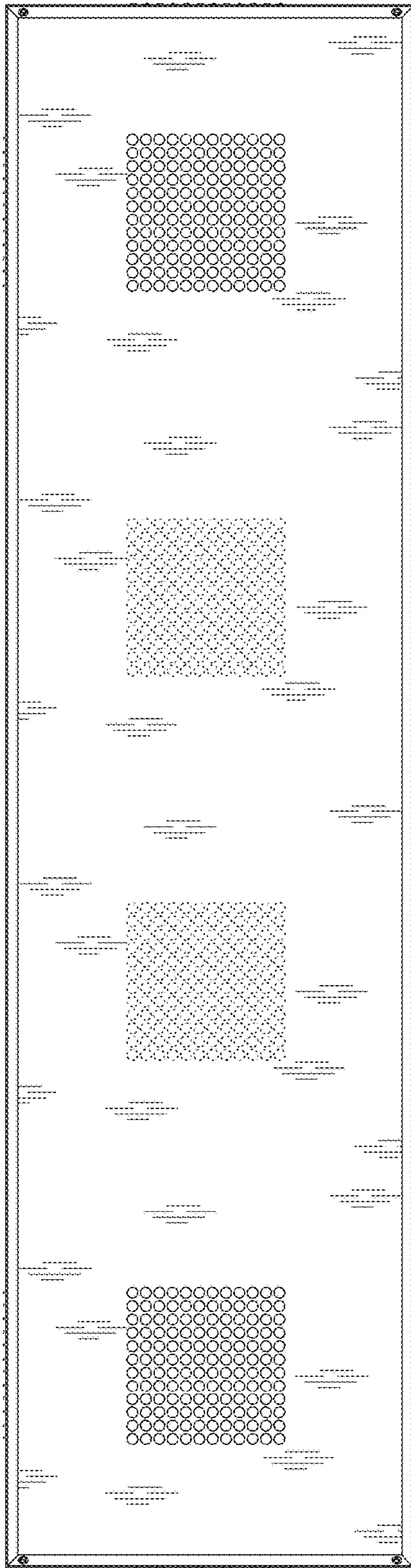

Fig. 20

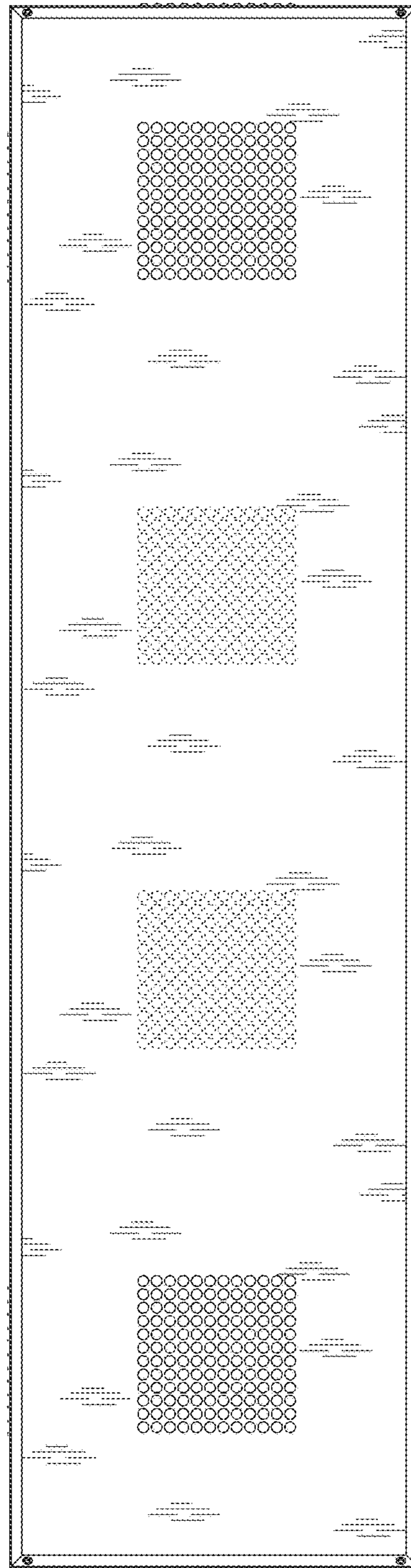

Fig. 21

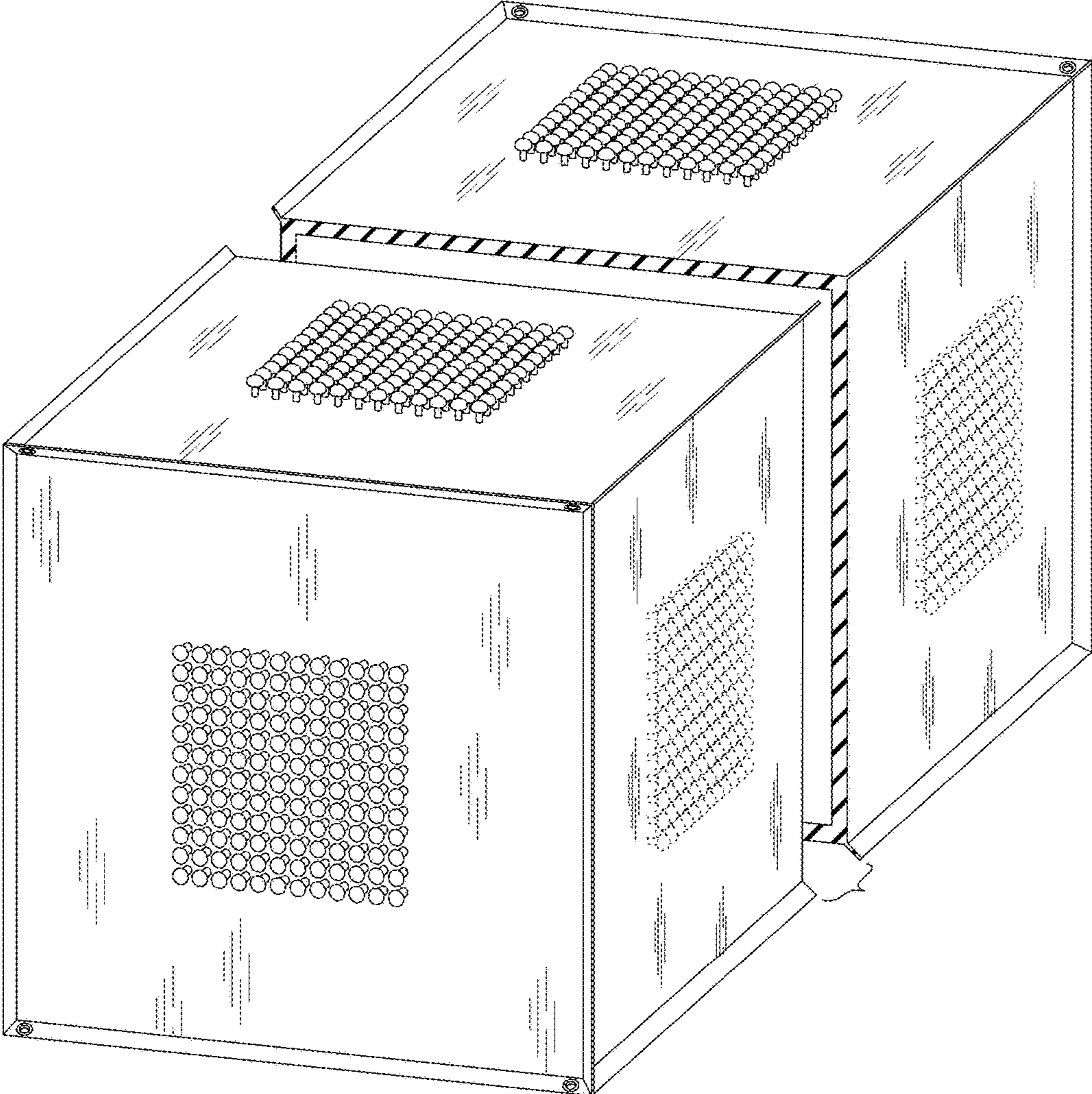

Fig. 22

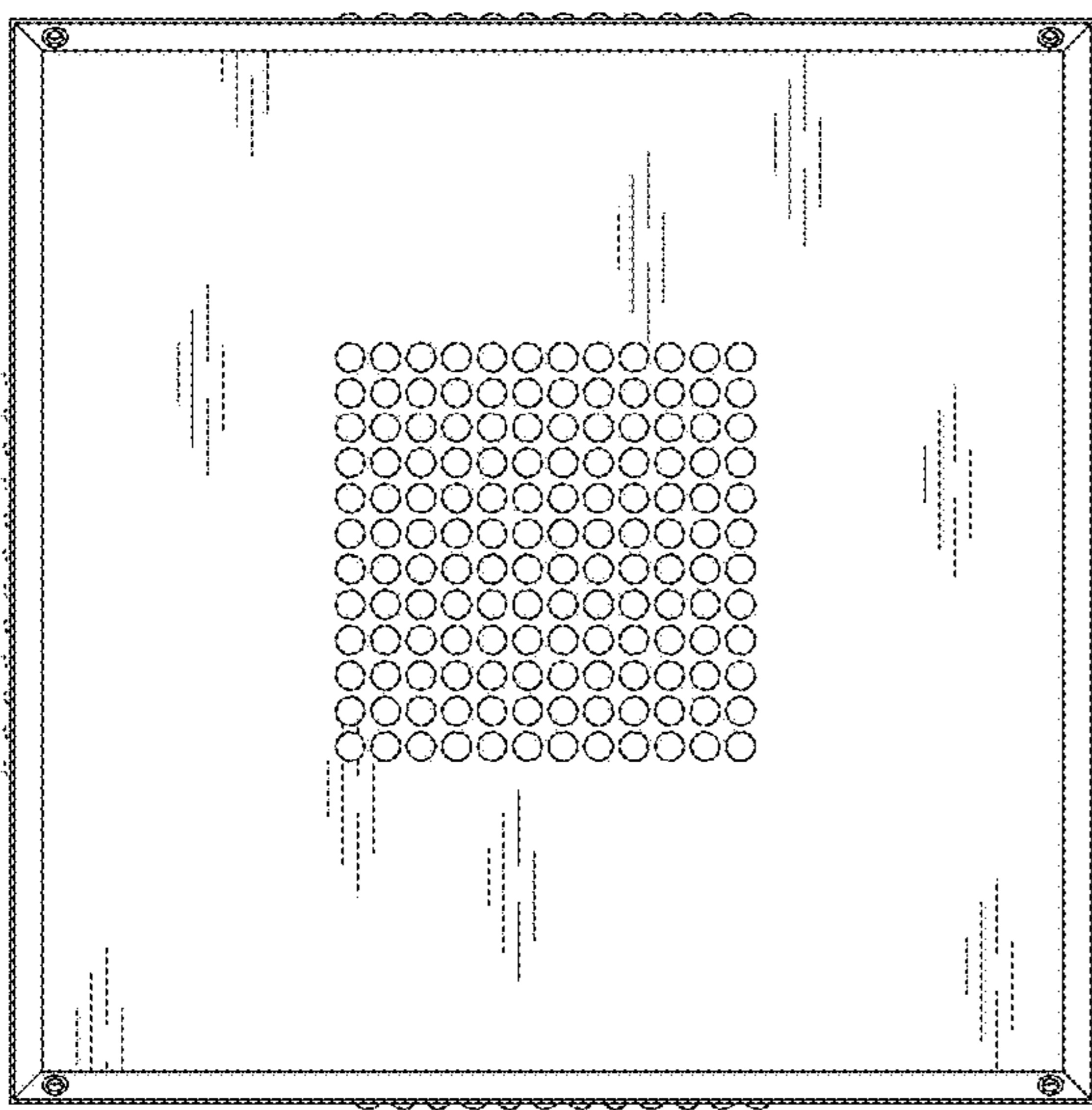

Fig. 23

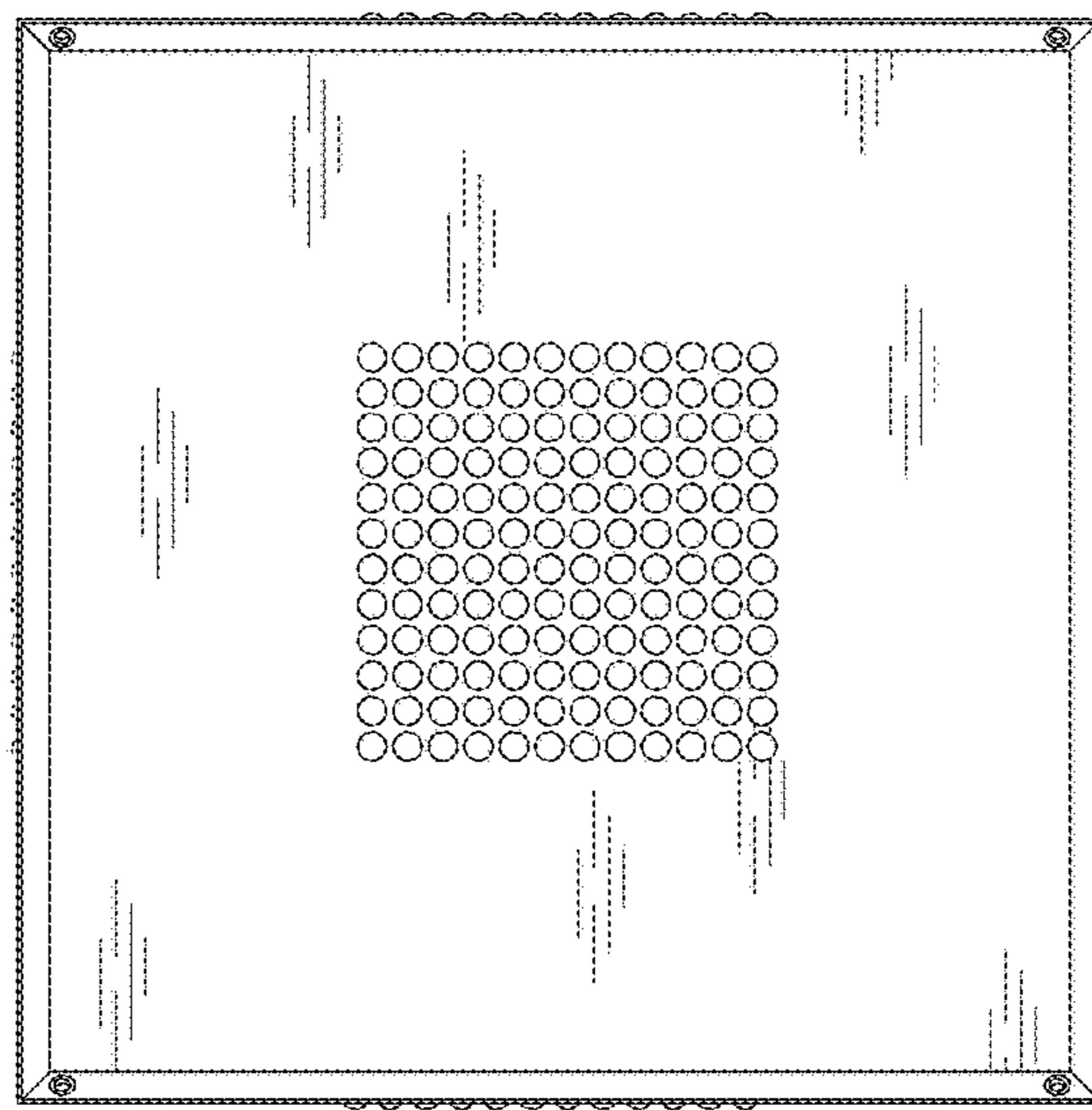

Fig. 24

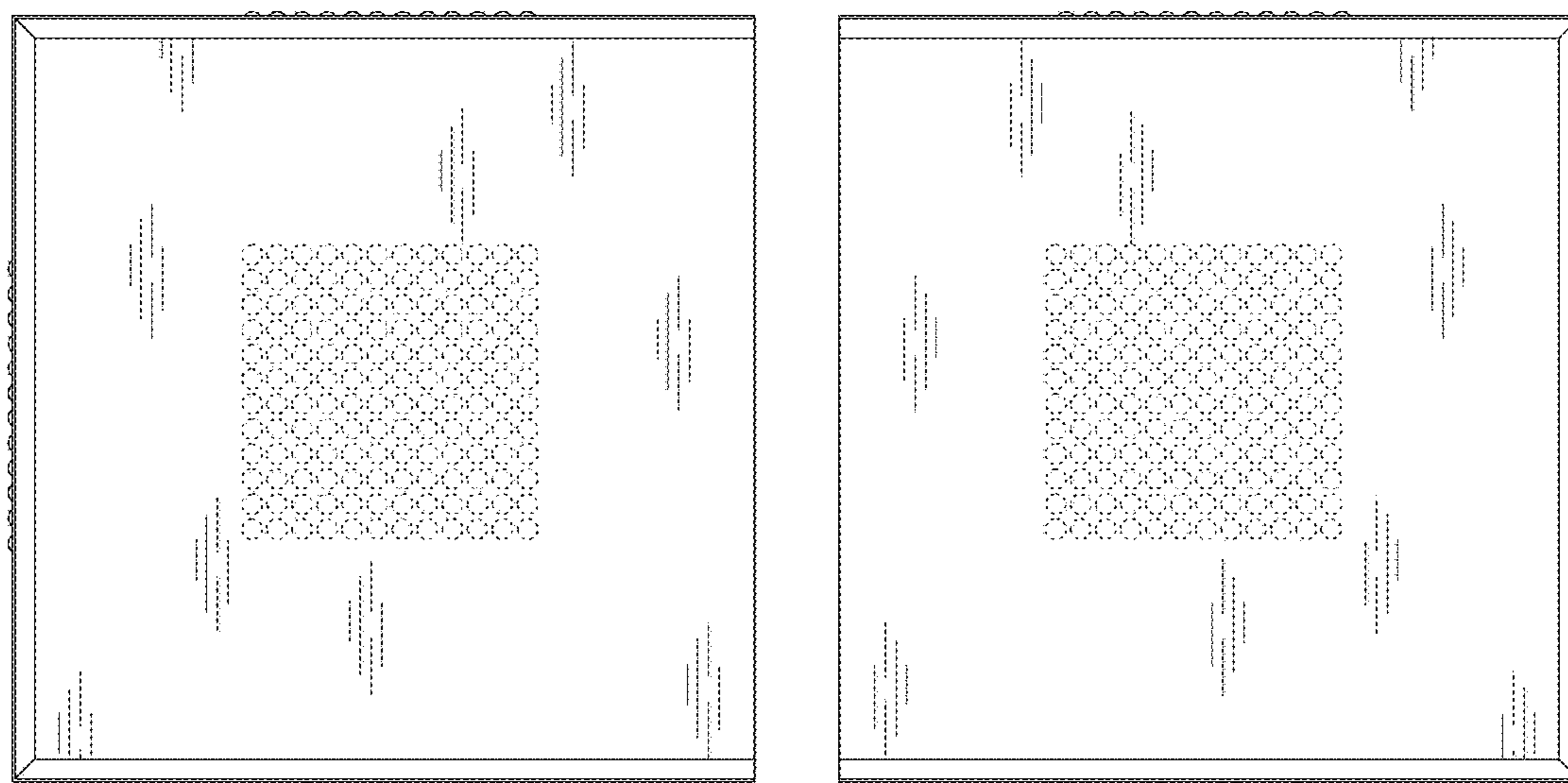

Fig. 25

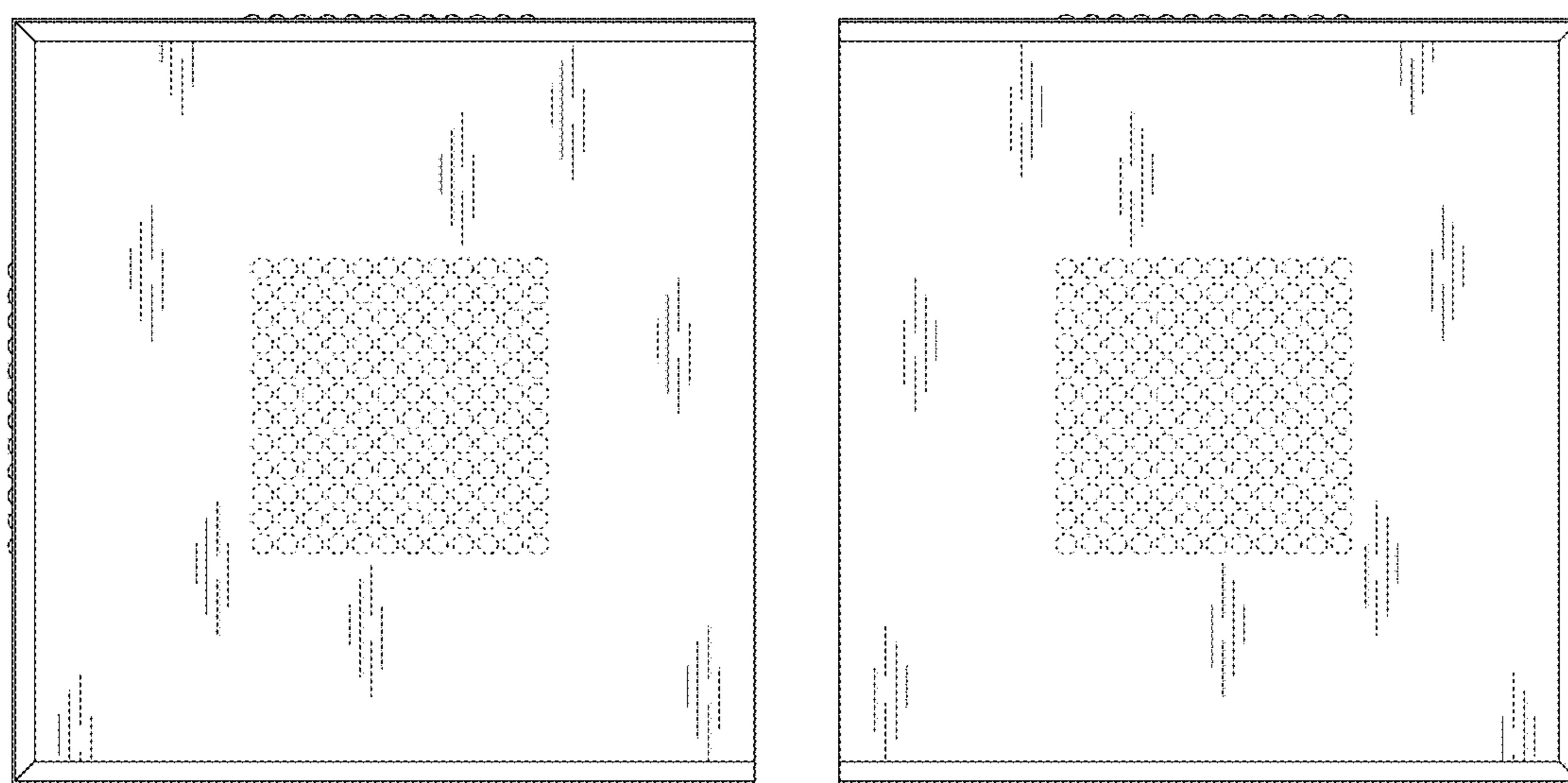

Fig. 26

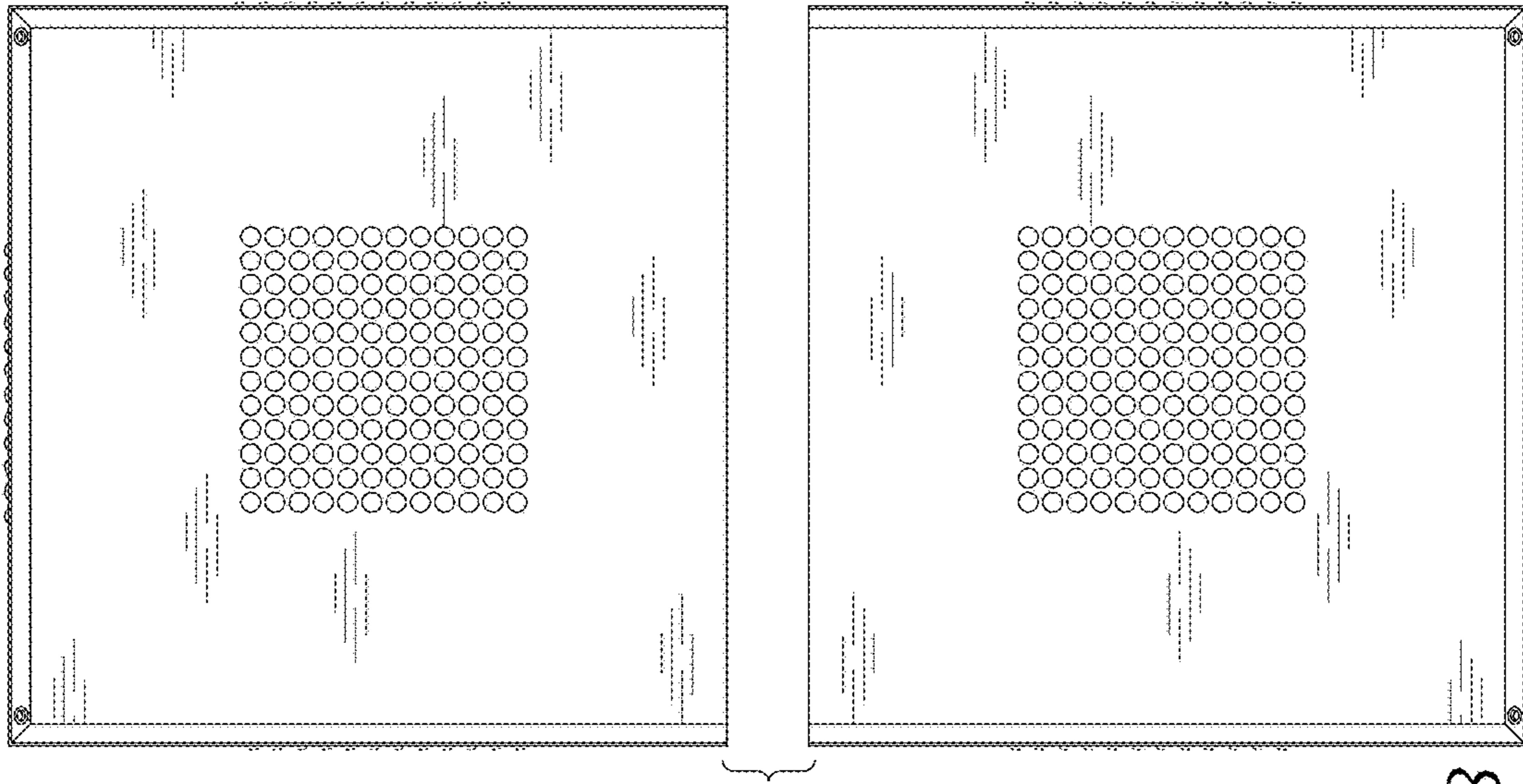

Fig. 28

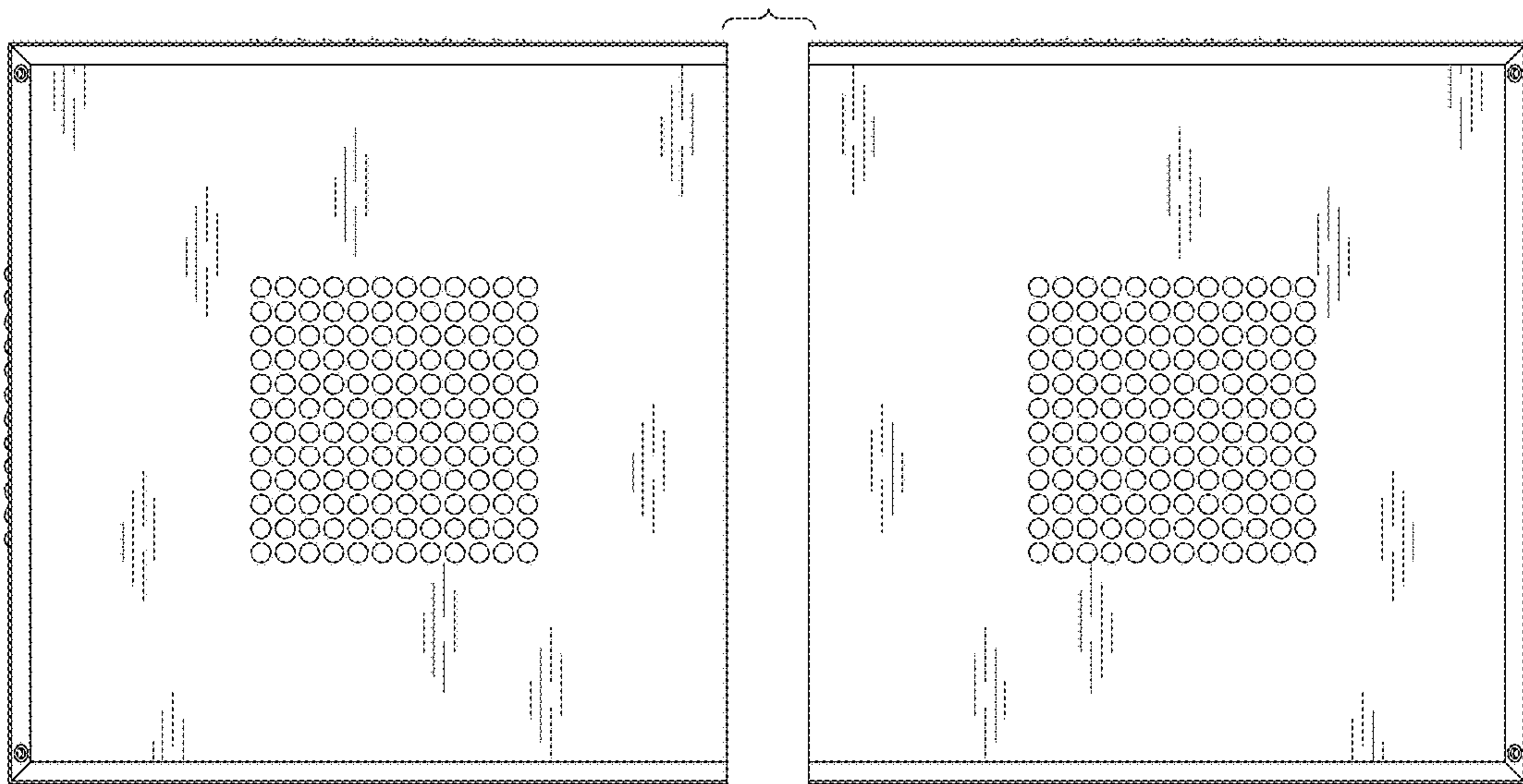

Fig. 27