



US00D803940S

(12) **United States Design Patent**
Vadenne

(10) **Patent No.:** **US D803,940 S**

(45) **Date of Patent:** **** Nov. 28, 2017**

(54) **WRITING INSTRUMENT**

(71) Applicant: **Societe BIC**, Clichy (FR)

(72) Inventor: **Franck Vadenne**, Bezons (FR)

(73) Assignee: **Societe BIC**, Clichy (FR)

(**) Term: **15 Years**

(21) Appl. No.: **29/549,693**

(22) Filed: **Dec. 28, 2015**

(30) **Foreign Application Priority Data**

Jun. 29, 2015 (EM) 002728006

(51) **LOC (10) Cl.** **19-06**

(52) **U.S. Cl.**
USPC **D19/184**; D19/918; D19/924

(58) **Field of Classification Search**
USPC D14/411; D19/115–204
CPC ... B43K 5/00; B43K 7/00; B43K 7/12; B43K
8/04; B43K 8/06; B43K 19/00; B43K
19/02; B43K 19/14; B43K 24/08
See application file for complete search history.

(56) **References Cited**

U.S. PATENT DOCUMENTS

D442,636 S *	5/2001	Kobayashi	D19/169
D452,526 S *	12/2001	Nishida	D19/166
D461,501 S *	8/2002	Nishida	D19/166
D487,771 S *	3/2004	Hwang	D19/166
D530,745 S *	10/2006	Kent	D19/166
D530,748 S *	10/2006	Kent	D19/195
D531,217 S *	10/2006	Hirota	D19/184
D541,342 S *	4/2007	Qiu	D19/166
D546,386 S *	7/2007	Qiu	D19/166

D546,387 S *	7/2007	Qiu	D19/166
D547,802 S *	7/2007	Jeon	D19/166
D548,789 S *	8/2007	Ternovits	D19/168
D563,471 S *	3/2008	Qiu	D19/167
D591,348 S *	4/2009	Yu	D19/168
D646,326 S *	10/2011	Koreska	D19/166
D679,323 S *	4/2013	Jiang	D19/179
D689,935 S *	9/2013	Li	D19/173
D692,483 S *	10/2013	Laemle	D19/172
D746,923 S *	1/2016	Fleming	D19/166
D747,770 S *	1/2016	Nishida	D19/199
D771,190 S *	11/2016	Laemle	D19/197

* cited by examiner

Primary Examiner — Elizabeth Albert

(74) *Attorney, Agent, or Firm* — Ohlandt, Greeley,
Ruggiero & Perle, L.L.P.

(57) **CLAIM**

The ornamental design for a writing instrument, as shown and described.

DESCRIPTION

FIG. 1 is a top, front, side perspective view of a writing instrument according to the present design;
FIG. 2 is a front view of the writing instrument of FIG. 1;
FIG. 3 is a rear view of the writing instrument of FIG. 1;
FIG. 4 is a right side view of the writing instrument of FIG. 1;
FIG. 5 is a left side view of the writing instrument of FIG. 1;
FIG. 6 is a top view of the writing instrument of FIGS. 1; and,
FIG. 7 is a bottom view of the writing instrument of FIG. 1.
The broken line showing of FIGS. 1-7 is for the purpose of illustrating environmental structure and forms no part of the claimed design.

1 Claim, 7 Drawing Sheets

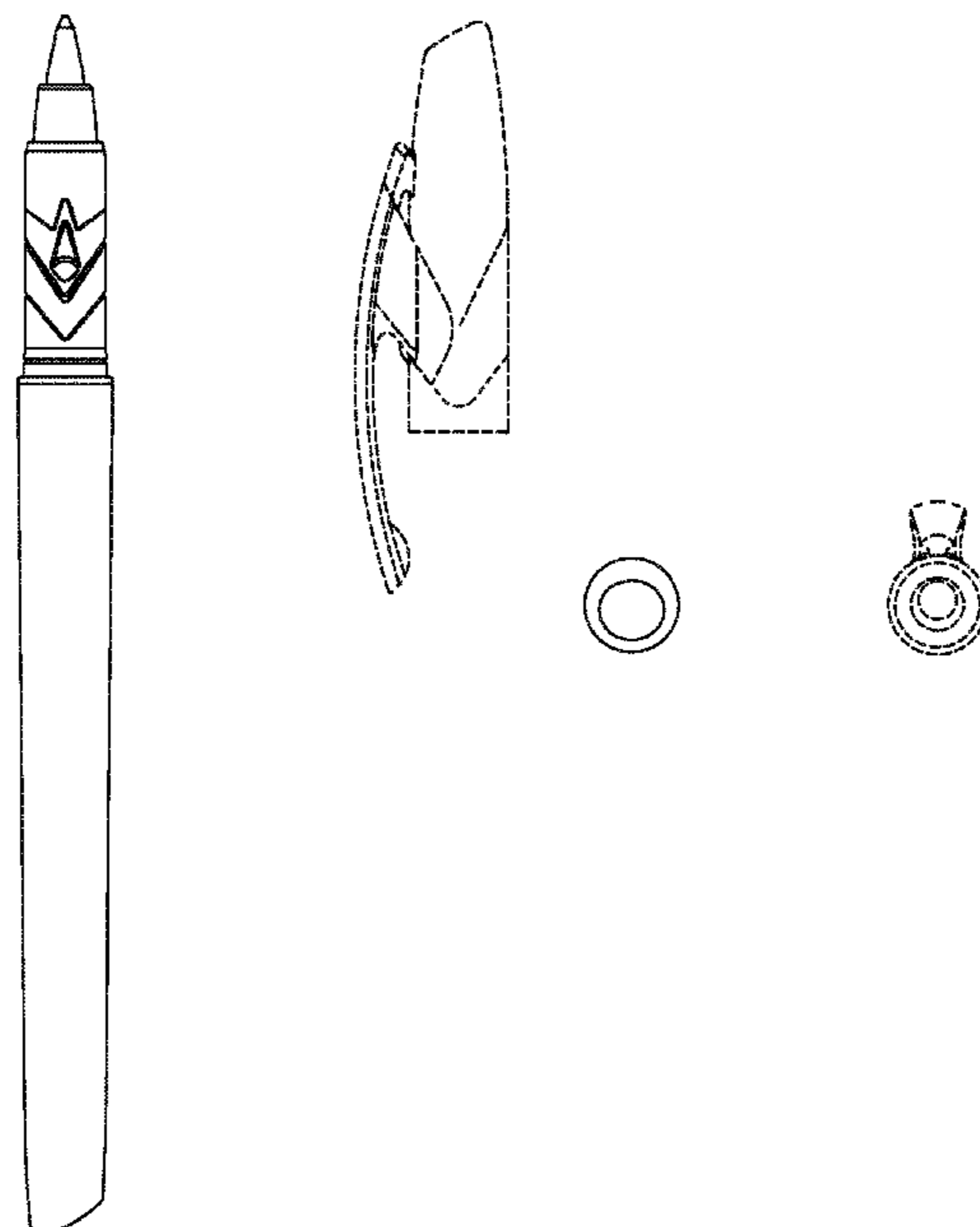

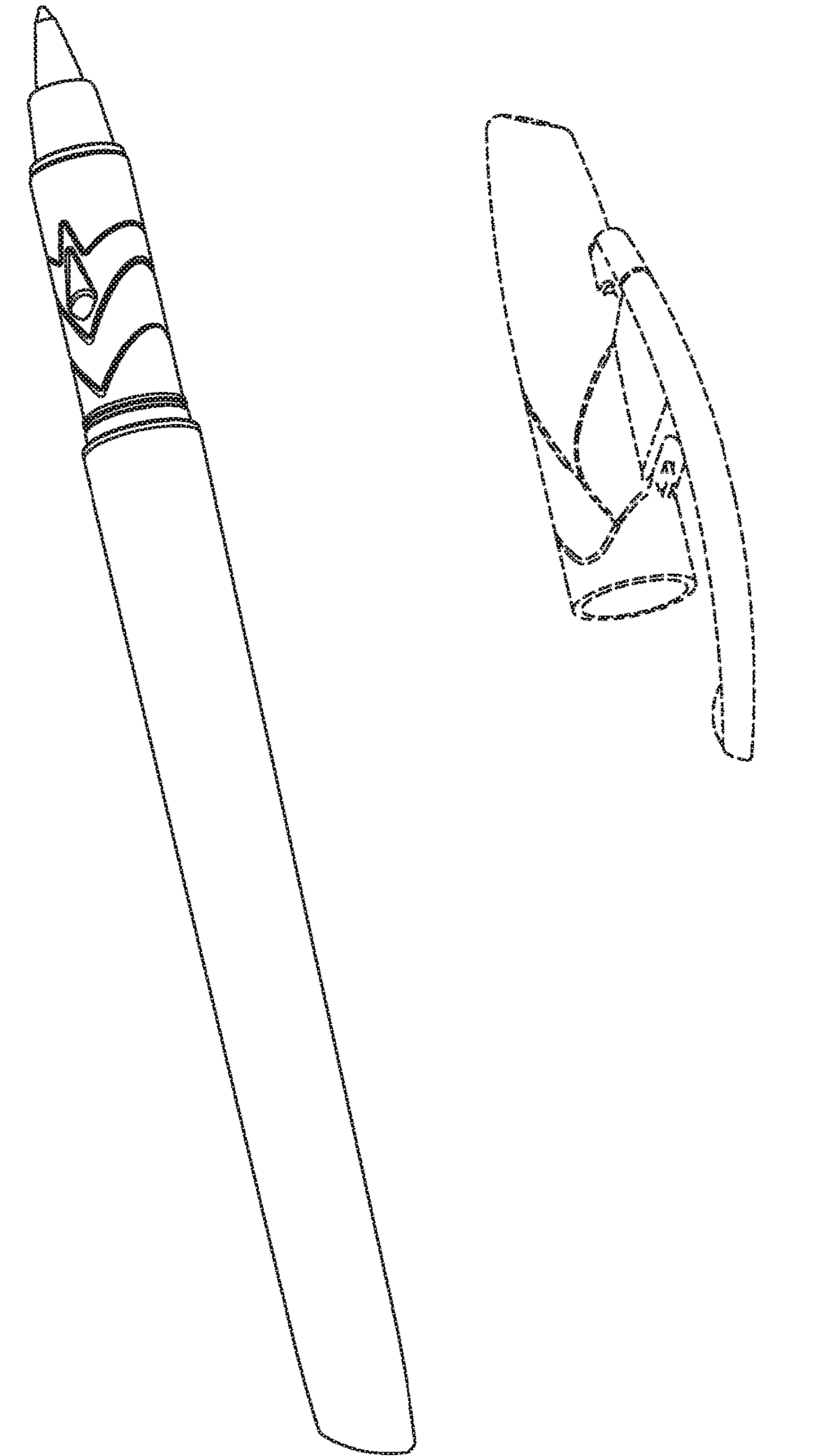

FIG. 1

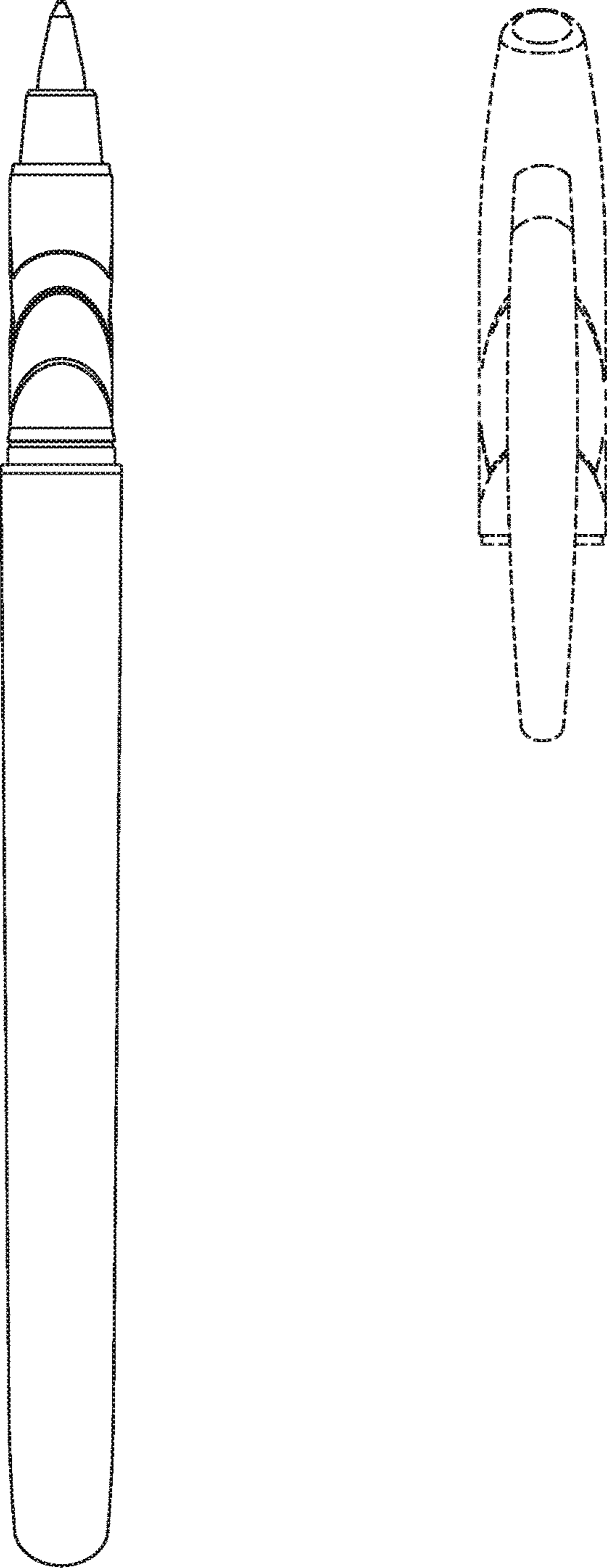

FIG. 2

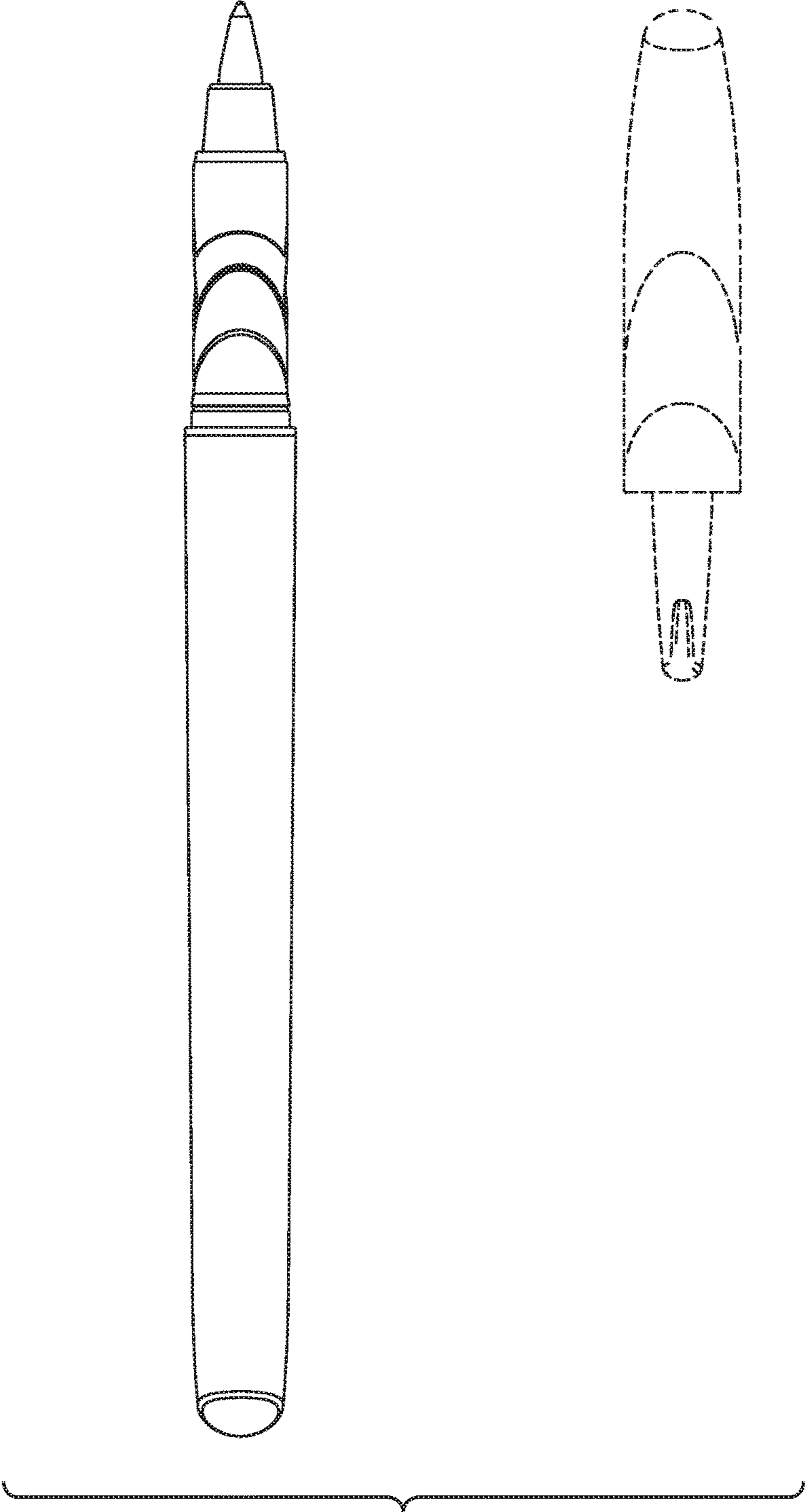

FIG. 3

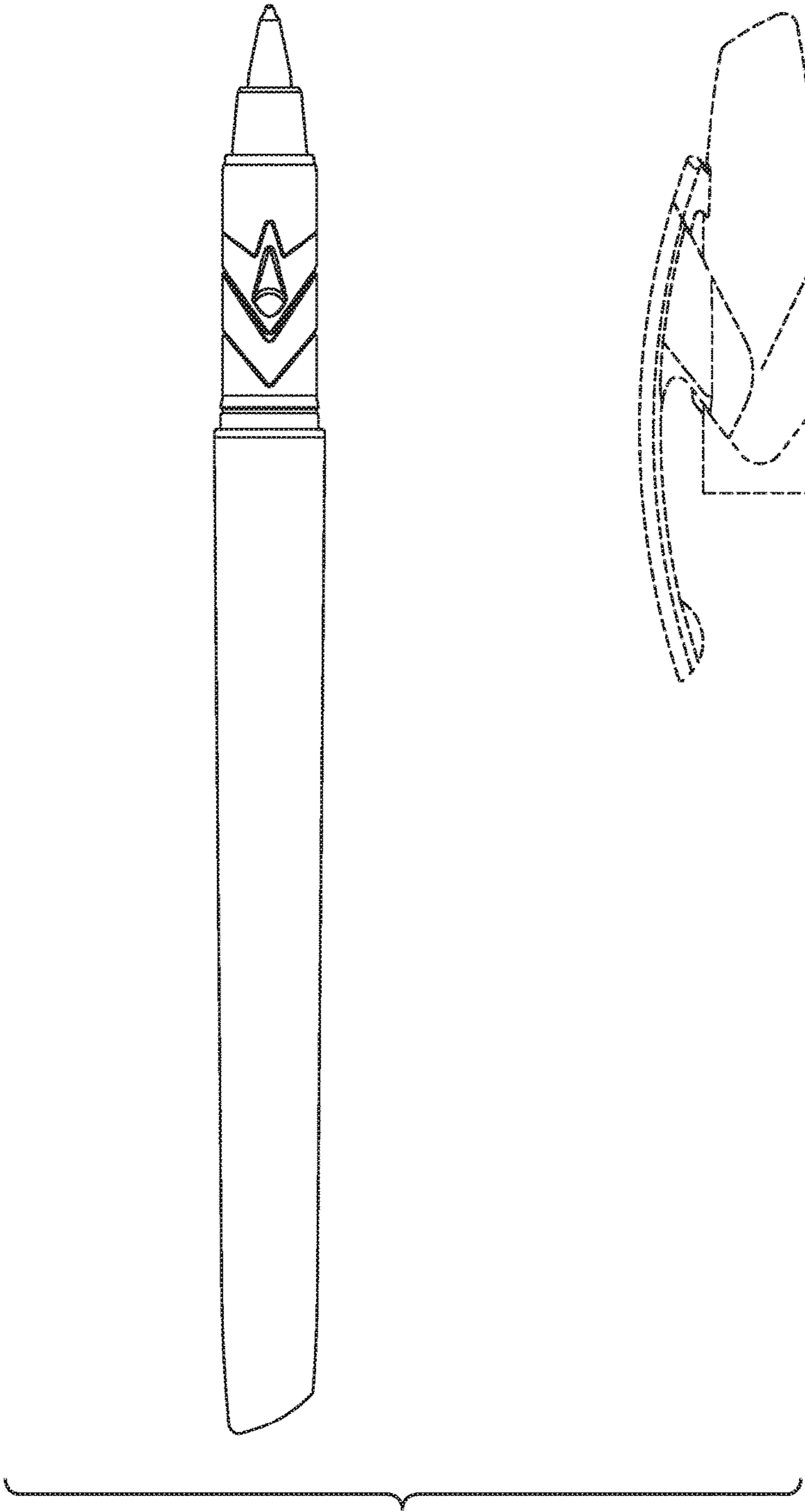

FIG. 4

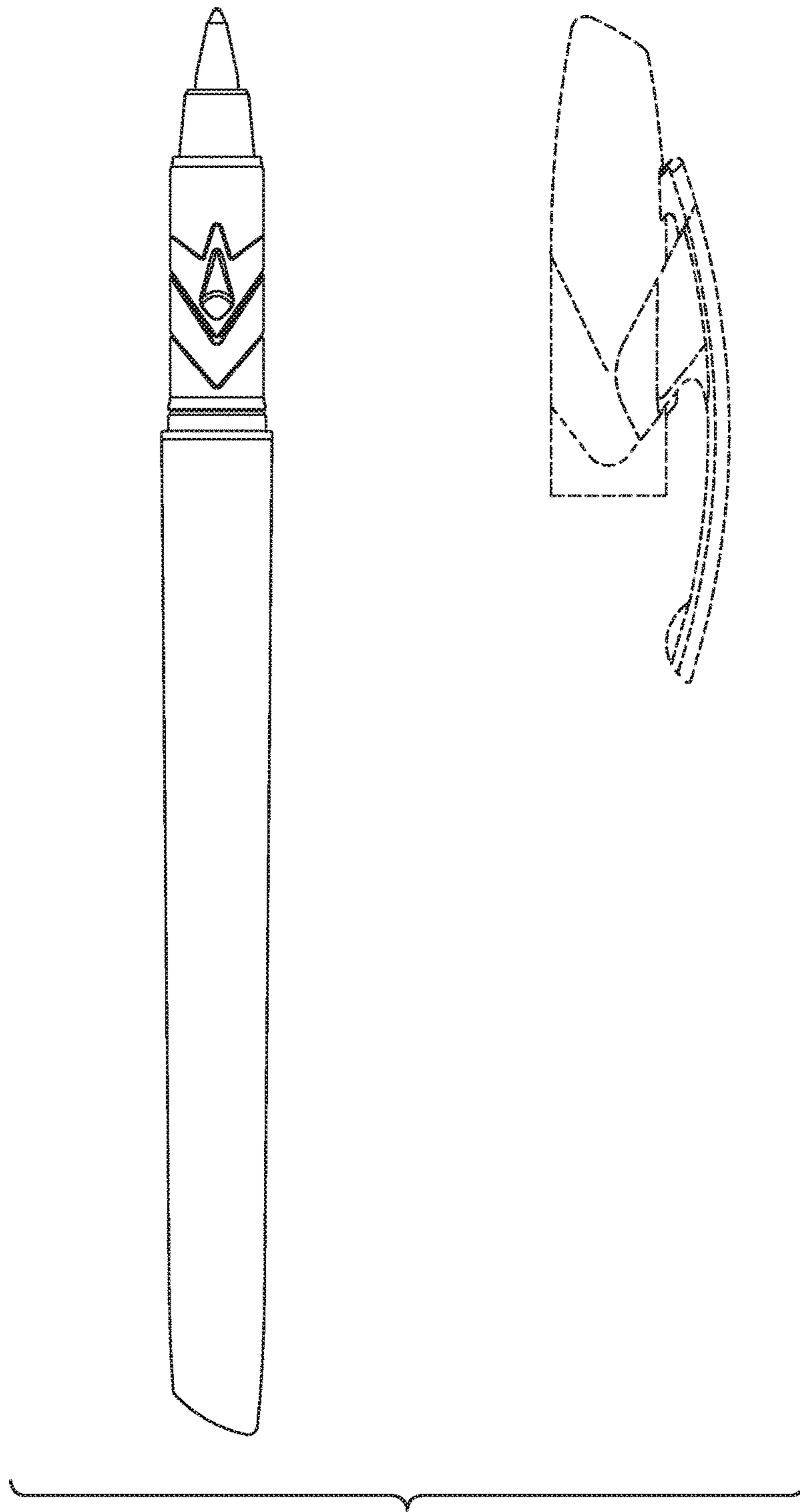

FIG. 5

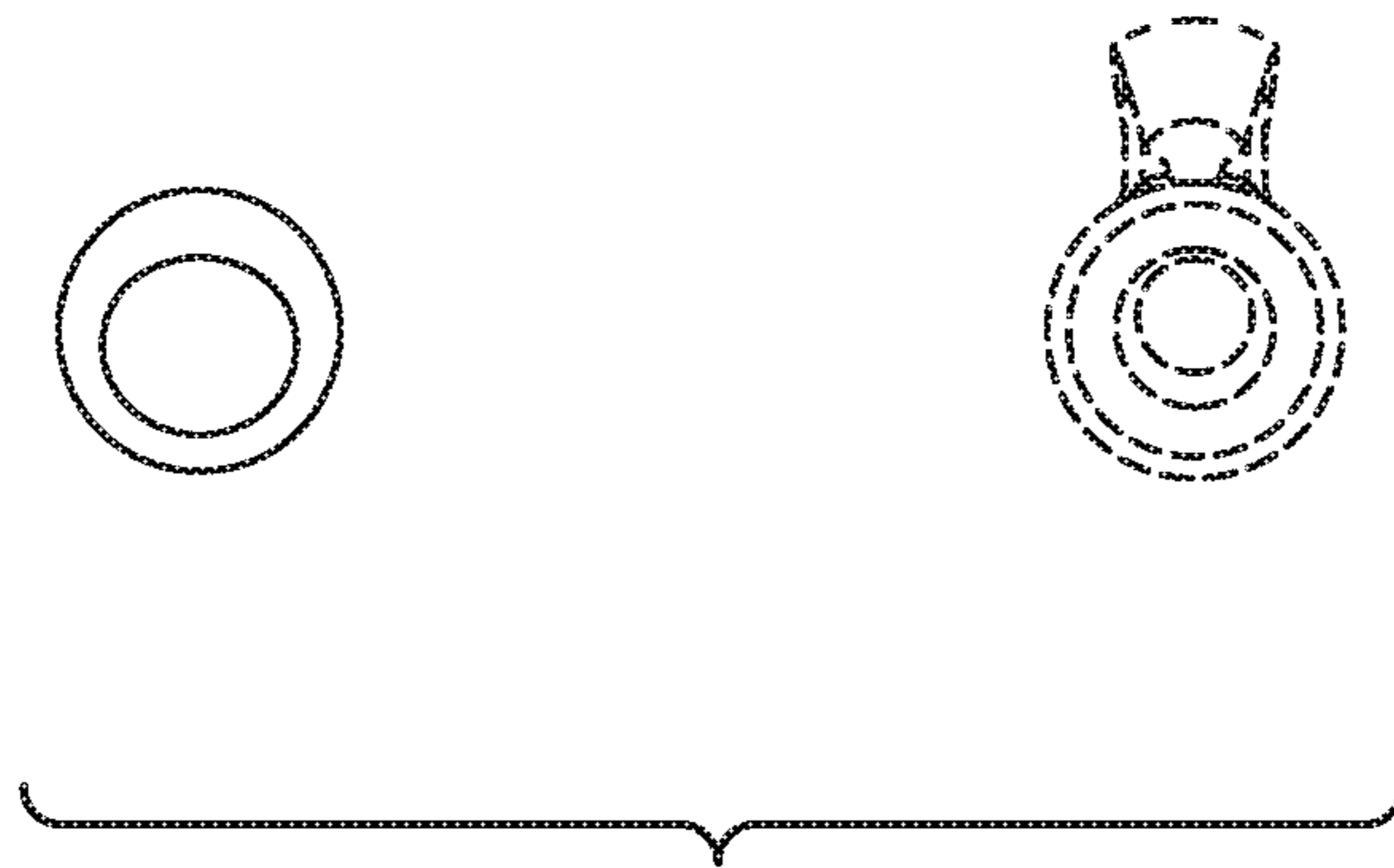

FIG. 6

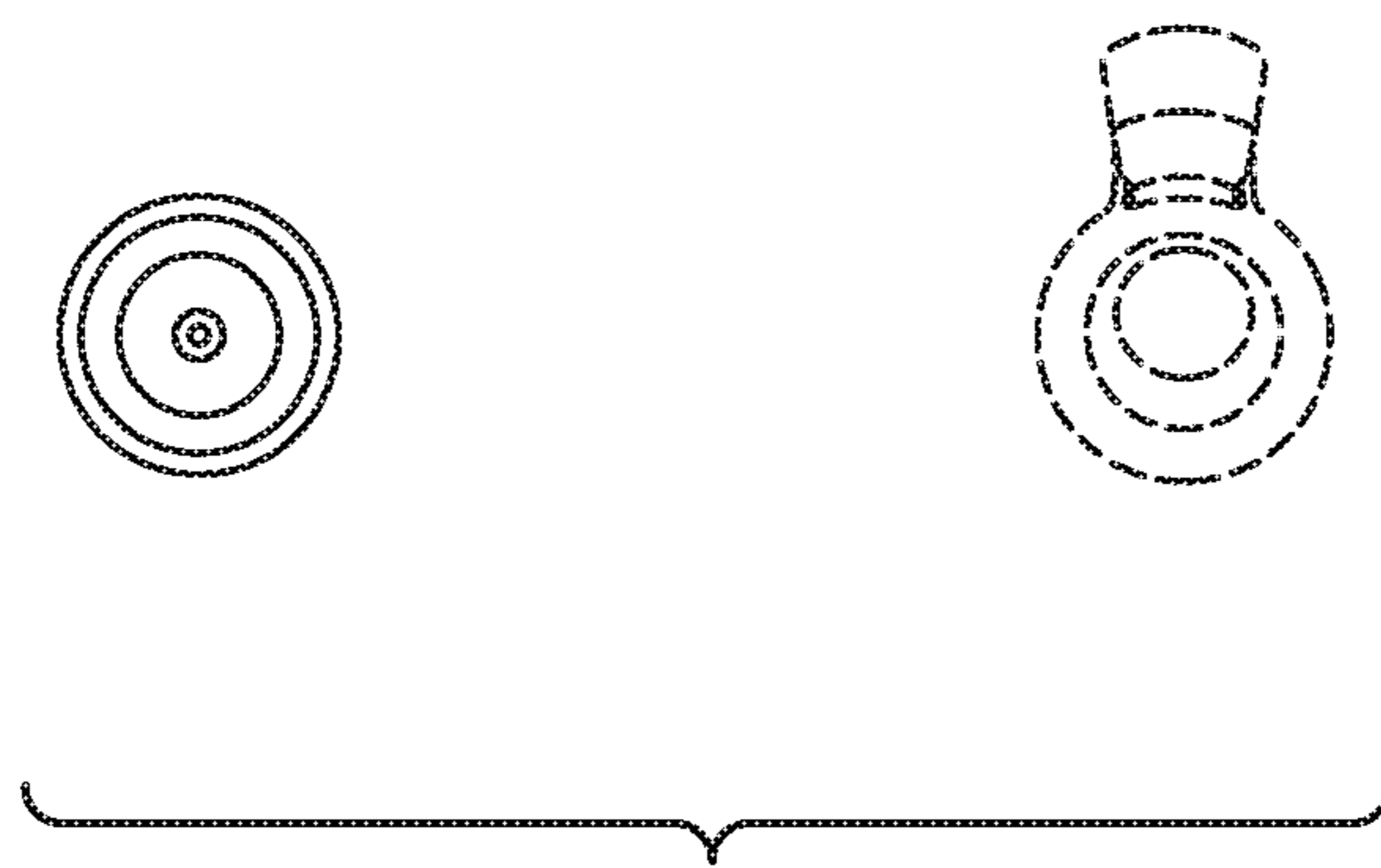

FIG. 7