



US00D803825S

(12) **United States Design Patent** (10) **Patent No.:** **US D803,825 S**
Akana et al. (45) **Date of Patent:** **** Nov. 28, 2017**

(54) **ELECTRONIC DEVICE**

(71) Applicant: **Apple Inc.**, Cupertino, CA (US)
(72) Inventors: **Jody Akana**, San Francisco, CA (US); **Molly Anderson**, San Francisco, CA (US); **Bartley K. Andre**, Palo Alto, CA (US); **Shota Aoyagi**, San Francisco, CA (US); **Anthony Michael Ashcroft**, San Francisco, CA (US); **Marine C. Bataille**, San Francisco, CA (US); **Jeremy Bataillou**, San Francisco, CA (US); **Daniele De Iuliis**, San Francisco, CA (US); **Markus Diebel**, San Francisco, CA (US); **M. Evans Hankey**, San Francisco, CA (US); **Julian Hoenig**, San Francisco, CA (US); **Richard P. Howarth**, San Francisco, CA (US); **Jonathan P. Ive**, San Francisco, CA (US); **Julian Jaede**, San Francisco, CA (US); **Duncan Robert Kerr**, San Francisco, CA (US); **Peter Russell-Clarke**, San Francisco, CA (US); **Benjamin Andrew Shaffer**, San Jose, CA (US); **Mikael Silvanto**, San Francisco, CA (US); **Christopher J. Stringer**, Woodside, CA (US); **Joe Sung-Ho Tan**, San Francisco, CA (US); **Clement Tissandier**, San Francisco, CA (US); **Eugene Antony Whang**, San Francisco, CA (US); **Rico Zörkendörfer**, San Francisco, CA (US)

(73) Assignee: **Apple Inc.**, Cupertino, CA (US)

(**) Term: **15 Years**

(21) Appl. No.: **29/574,078**

(22) Filed: **Aug. 11, 2016**

(51) **LOC (10) Cl.** **14-02**

(52) **U.S. Cl.**
USPC **D14/315**

(58) **Field of Classification Search**

USPC D14/315-327; D18/1, 2, 7, 11; 235/145 A, 145 R; 341/22, 23; 345/104, 345/156, 168, 169, 173; 361/679.08, 361/679.09, 679.11, 679.26, 679.27
CPC G06F 1/16; G06F 1/1616; G06F 1/1626; G06F 1/1632; G06F 1/1613; G06F 1/1601; G06F 1/1618; G06F 1/162; G06F 1/166; G06F 1/1654; G06F 1/1681; G06F 1/1637; G06F 1/1688; G06F 1/1656; H01R 35/02; H03M 11/00; G09B 13/04; H03K 17/94; G09G 5/00; F16M 11/10; H05K 5/00; H04M 1/0237

See application file for complete search history.

(56) **References Cited**

U.S. PATENT DOCUMENTS

D264,969 S	6/1982	McGourty
4,976,435 A	12/1990	Shatford et al.
5,192,082 A	3/1993	Inoue et al.
D345,346 S	3/1994	Alfonso et al.
D349,923 S	8/1994	Billings et al.
D359,306 S	6/1995	Lande et al.
D362,272 S	9/1995	Luong
D362,461 S	9/1995	Luong
D378,686 S	4/1997	Proctor et al.
5,661,632 A	8/1997	Register
D385,299 S	10/1997	Adams
D386,521 S	11/1997	Eisenbaum
5,694,292 A	12/1997	Paulsel et al.
5,694,294 A	12/1997	Ohashi et al.
5,713,790 A	2/1998	Lin
D391,927 S	3/1998	Faranda et al.
D396,452 S	7/1998	Naruki
5,793,355 A	8/1998	Youens
D399,526 S	10/1998	Brady
D402,310 S	12/1998	Hendricks
D410,028 S	5/1999	Fyffe
D412,940 S	8/1999	Kato et al.
5,964,661 A	10/1999	Dodge
D416,238 S	11/1999	Irie et al.
6,038,128 A	3/2000	Hood et al.
D425,558 S	5/2000	Tarpenning et al.
D425,874 S	5/2000	Tanimura
6,067,224 A	5/2000	Nobuchi
D430,117 S	8/2000	Sachs et al.
D430,169 S	8/2000	Scibora
D431,821 S	10/2000	Mizuno

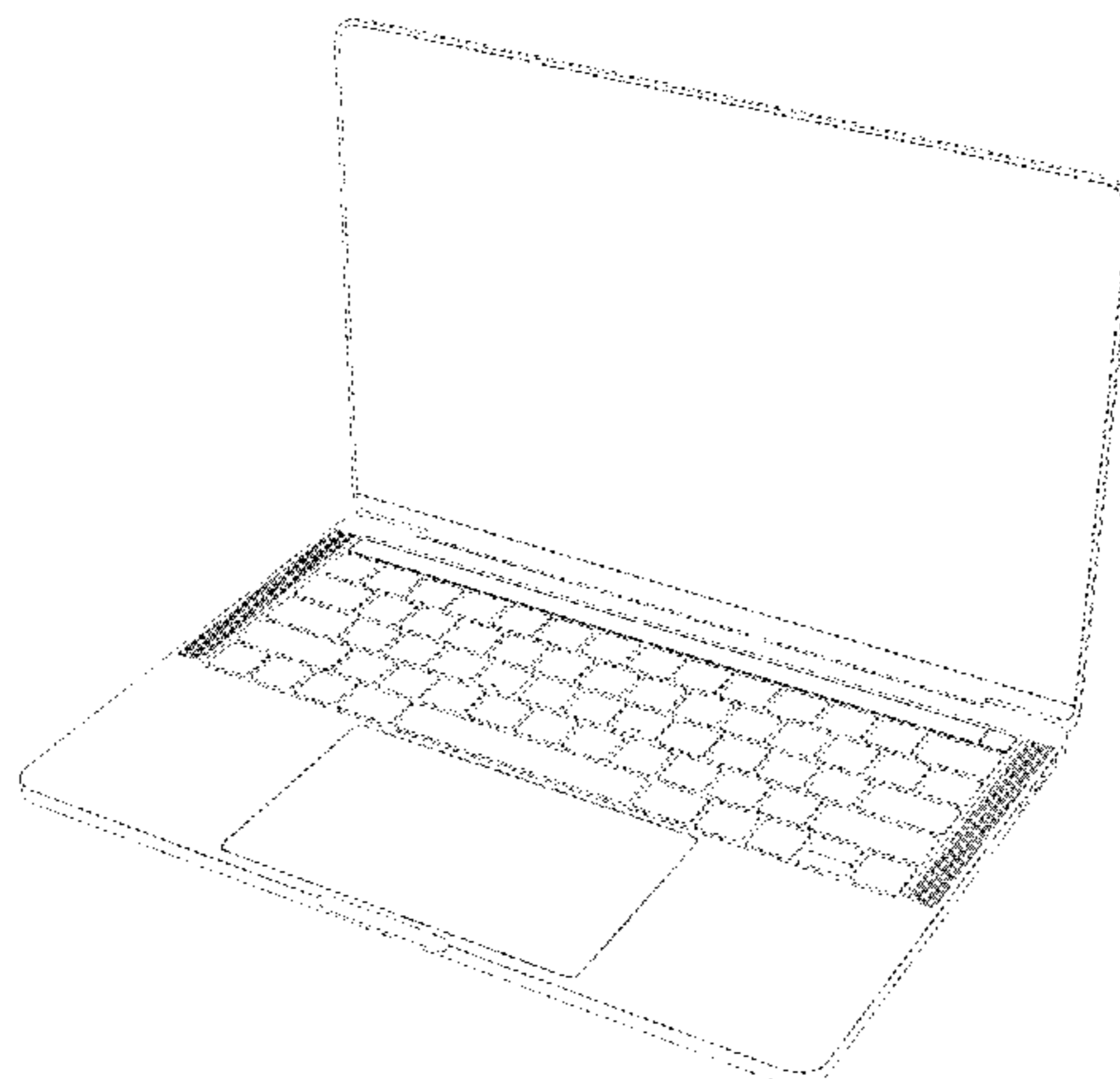

US D803,825 S

6,166,737 A	12/2000	Lee et al.	D616,488 S	5/2010	Gonzalez	
D437,860 S	2/2001	Suzuki et al.	D616,880 S	6/2010	Andre et al.	
D445,787 S	7/2001	Francis	D616,881 S	6/2010	Andre et al.	
6,254,477 B1	7/2001	Sasaki et al.	D617,789 S	6/2010	Akana et al.	
D448,810 S	10/2001	Goto	7,733,636 B2	6/2010	Kobayashi et al.	
D449,606 S	10/2001	Lee et al.	D621,409 S	8/2010	Andre et al.	
D450,713 S	11/2001	Masamitsu et al.	D621,825 S	8/2010	Andre et al.	
D452,250 S	12/2001	Chan	D622,268 S	8/2010	Hong et al.	
D452,505 S	12/2001	Stewart et al.	D623,645 S	9/2010	Andre et al.	
D453,333 S	2/2002	Chen	D625,716 S	10/2010	Andre et al.	
D458,252 S	6/2002	Palm et al.	D625,717 S	10/2010	Andre et al.	
D463,797 S	10/2002	Andre et al.	D633,087 S	2/2011	Andre et al.	
D469,109 S	1/2003	Andre et al.	D633,488 S	3/2011	Kim et al.	
D472,245 S	3/2003	Andre et al.	D633,907 S	3/2011	Andre et al.	
D481,036 S	10/2003	Wentt	D635,566 S	4/2011	Andre et al.	
6,657,854 B2	12/2003	Horii et al.	7,948,752 B2	5/2011	Tatsukami et al.	
D486,823 S	2/2004	Kuo	D639,295 S	6/2011	Andre et al.	
D487,457 S	3/2004	Liu	D642,172 S	7/2011	Akana et al.	
D487,742 S	3/2004	Huang et al.	D642,560 S	8/2011	Akana et al.	
D489,717 S	5/2004	Hsieh	D648,333 S	11/2011	Andre et al.	
D490,420 S	5/2004	Solomon et al.	D648,334 S	11/2011	Andre et al.	
D491,177 S	6/2004	Andre et al.	D652,032 S	1/2012	Akana et al.	
D491,933 S	6/2004	Guo	D654,072 S	2/2012	Andre et al.	
D491,936 S	6/2004	Jao	D655,704 S	3/2012	Akana et al.	
6,744,623 B2	6/2004	Numano et al.	8,139,352 B2	3/2012	Yamamoto et al.	
D493,785 S	8/2004	Andre et al.	D657,786 S	4/2012	Andre et al.	
D494,164 S	8/2004	Wu et al.	8,170,266 B2 *	5/2012	Hopkinson	H04R 1/023 361/679.01
6,771,494 B2	8/2004	Shimano				
D497,618 S	10/2004	Andre et al.	D661,296 S	6/2012	Akana et al.	
D501,472 S	2/2005	Kumano	D662,497 S	6/2012	Akana et al.	
D501,660 S	2/2005	Kumano	D664,537 S	7/2012	Hu et al.	
6,876,546 B2	4/2005	Tsao	8,223,487 B2	7/2012	Chen et al.	
D504,889 S	5/2005	Andre et al.	8,238,090 B2	8/2012	Watanabe	
6,932,525 B2	8/2005	Trotman	8,339,775 B2	12/2012	Degner et al.	
D512,997 S	12/2005	Lee et al.	D674,382 S	1/2013	Andre et al.	
6,972,946 B2	12/2005	Hamada et al.	D676,437 S	2/2013	Akana et al.	
D513,509 S	1/2006	Kawa	D676,438 S	2/2013	Akana et al.	
D517,063 S	3/2006	Nakajima et al.	D679,704 S	4/2013	McManigal et al.	
7,012,802 B2	3/2006	Nakajima et al.	D679,705 S	4/2013	McManigal et al.	
7,035,665 B2	4/2006	Kido et al.	D682,821 S	5/2013	Kim et al.	
D523,429 S	6/2006	Lin	D685,784 S	7/2013	Ma	
D524,306 S	7/2006	Yun et al.	D686,205 S	7/2013	Akana et al.	
D526,999 S	8/2006	Tago	D687,030 S	7/2013	Andre et al.	
D527,730 S	9/2006	Dong	D687,031 S	7/2013	Chen et al.	
D529,907 S	10/2006	Dong	D691,128 S	10/2013	Akana et al.	
D533,550 S	12/2006	Yamada	D691,129 S	10/2013	Akana et al.	
D547,310 S	7/2007	Yoon	D694,748 S	12/2013	Okuley et al.	
D556,192 S	11/2007	Jeong et al.	D696,244 S	12/2013	Akana et al.	
D558,752 S	1/2008	Andre et al.	D696,569 S	12/2013	Luo	
D558,753 S	1/2008	Andre et al.	D696,660 S	12/2013	Chen et al.	
D571,364 S	6/2008	Andre et al.	D696,661 S	12/2013	Chen et al.	
D572,246 S	7/2008	Andre et al.	8,687,359 B2	4/2014	Theobald et al.	
D572,247 S	7/2008	Andre et al.	8,734,036 B2	5/2014	Hirsch	
D574,378 S	8/2008	Andre et al.	D706,759 S	6/2014	Myung et al.	
7,426,113 B2	9/2008	Ikeno et al.	D706,772 S	6/2014	Koyama et al.	
D581,411 S	11/2008	Kumano	D708,176 S	7/2014	Akana et al.	
D589,507 S	3/2009	Andre et al.	D708,179 S	7/2014	Andre et al.	
D596,633 S *	7/2009	Kawase	D717,787 S	11/2014	Jung et al.	
D600,688 S	9/2009	Andre et al.	D718,766 S *	12/2014	Tsuda	D14/396
D601,556 S	10/2009	Iseki	D719,149 S	12/2014	Matsuoka	
D603,861 S	11/2009	Hong et al.	8,947,874 B2 *	2/2015	Andre	G06F 1/1616 361/679.26
D604,289 S	11/2009	Andre et al.				
D604,290 S	11/2009	Andre et al.	D723,539 S	3/2015	Andre et al.	
D604,291 S	11/2009	Andre et al.	D729,227 S	5/2015	Fukuoka	
D604,292 S	11/2009	Andre et al.	D734,334 S *	7/2015	Tsuda	D14/392
D604,293 S	11/2009	Andre et al.	D741,316 S	10/2015	Andre et al.	
D604,294 S	11/2009	Andre et al.	D776,107 S	1/2017	Akana et al.	
D606,068 S	12/2009	Hong et al.	2005/0008418 A1	1/2005	Green	
D606,534 S	12/2009	Hong et al.	2005/0180794 A1	8/2005	Parkinson	
D606,988 S	12/2009	Andre et al.	2005/0207817 A1	9/2005	Jenkins	
D606,989 S	12/2009	Andre et al.	2006/0147239 A1	7/2006	Kurriss	
D607,450 S	1/2010	Morishita et al.	2006/0257191 A1	11/2006	Artus	
7,660,104 B2	2/2010	Ligtenberg	2008/0074833 A1	3/2008	Chien et al.	
D611,043 S	3/2010	Andre et al.	2010/0067182 A1	3/2010	Tanaka et al.	
D611,044 S	3/2010	Andre et al.	2010/0091442 A1 *	4/2010	Theobald	G06F 1/1616 361/679.09
D611,045 S	3/2010	Andre et al.				
D611,469 S	3/2010	Andre et al.				
D612,843 S	3/2010	Andre et al.	2011/0255727 A1	10/2011	Azuchi	
D613,284 S	4/2010	Solomon et al.	2012/0099263 A1	4/2012	Lin	

FOREIGN PATENT DOCUMENTS

CN	301384975	11/2010
JP	1128620	12/2001
JP	1438161	4/2012
JP	1469539	5/2013
KR	30-0608518-0000	8/2011
KR	30-0613298-0000	9/2011
KR	30-0687340-0000	4/2013

OTHER PUBLICATIONS

Sony X505, available at least as early as May 8, 2005.
 HP Compaq Tablet PC Tc 1100, http://web.archive.org/web/20040726084509/h_18000.www1.hp.com/products/tabletpc/, downloaded Aug. 27, 2004.
 Tablet PC V1100, <http://web.archive.org/web/20040714060448/www.viewsonic.com/products/desktopdisplays/tabletpc/tabletpcv1100/>, downloaded Aug. 27, 2004.
 VIA Tablet PC Reference Design: The Digital Notepad, <http://www.via.com/en/initiatives/spearhead/information-pc/>, downloaded Aug. 27, 2004.
 ViewPad 1000, http://www.viewsonic.com/support/mobilewireless/tabletpc/viewpad1000_index.htm, downloaded Aug. 27, 2004.
 Photographs of Sony VAIO PCG-4G1L, available at least as early as May 8, 2006.
 Apple PowerBook G4 Titanium, available at least as early as Jan. 1, 2001.
 Apple PowerBook G4 Aluminum, available at least as early as Jan. 1, 2003.
 Apple MacBook Pro, available at least as early as Jan. 10, 2006.
 Apple MacBook Air, available Jan. 15, 2008, http://images.apple.com/macbookair/images/design_galo1_20080115.jpg.
 Apple MacBook Air, available Jan. 15, 2008, http://images.apple.com/macbookair/images/design_galo2_20080115.jpg.
 Apple MacBook Air, available Jan. 15, 2008, http://images.apple.com/macbookair/images/design_galo3_20080115.jpg.
 Apple MacBook Air, available Jan. 15, 2008, http://images.apple.com/macbookair/images/design_galo4_20080115.jpg.
 Apple MacBook Air, available Jan. 15, 2008, http://images.apple.com/macbookair/images/design_thinair20080115.
 Apple MacBook Air, available Jan. 15, 2008, http://images.apple.com/macbookair/images/design_displayair20080115.jpg.
 Apple MacBook Air, available Jan. 15, 2008, http://images.apple.com/macbookair/images/design_keyboardair20080115.jpg.
 Apple MacBook Air, available Jan. 15, 2008, http://images.apple.com/macbookair/images/design_galo8_20080115.jpg.
 Appendix in U.S. Appl. No. 29/201,636, entitled "Electronic Device" filed Mar. 17, 2004, now U.S. Pat. No. D504,889.

Olidata Altro, available at least as early as Jun. 1, 2009.
 Olidata Altro, <http://notebookitalia.it/olidata-altro-italian-style-notebook-culv-5674.html>, published Mar. 3, 2009.
 Rudi, 13-inch MacBook Air has a modern interior, Nov. 2, 2011, prohardver, 2pgs.
 Sharp Corporation, Sharp Releases Notebook PC with Optical Sensor LCD Pad, "Mebius", <http://www.sharp.co.jp/corporate/news/090421-a.html>, available as early as Apr. 21, 2009.
 Designboom, Lenovo Yoga 3 Pro Laptop's Flexible-Use Stabilized by Watchband Hinge, <http://www.designboom.com/technology/lenovo-yoga-3-pro-laptop-10-10-2014/>, available as early as Oct. 10, 2014.
 Mark Gurman, Apple's next major Mac revealed: the radically new 12-inch MacBook Air, <https://9to5mac.com/2015/01/06/macbook-air-12-inch-redesign/>, available as early as Jan. 6, 2015.
 Best Buy Co., Inc., <http://www.bestbuy.com/site/olspage.jsp?id=cat13506&type=page&skuId=9441909&productId=1218105184065&navigation=next&count=1&chk=true&h=387>, available as early as Sep. 4, 2009.
 17-inch Apple MacBook Pro Review, http://www.laptopmag.com/uploadedimages/review/laptops/2009/apple/macbook_pro_2561g.jpg, available as early as Feb. 25, 2009.

* cited by examiner

Primary Examiner — Freda S Nunn
 (74) *Attorney, Agent, or Firm* — Saidman DesignLaw Group, LLC

(57)

CLAIM

The ornamental design for an electronic device, as shown and described.

DESCRIPTION

FIG. 1 is a front top perspective view of an electronic device showing our new design in an opened position;
 FIG. 2 is a rear bottom perspective view thereof;
 FIG. 3 is a front view thereof;
 FIG. 4 is a rear view thereof;
 FIG. 5 is a left side view thereof;
 FIG. 6 is a right side view thereof;
 FIG. 7 is a top view thereof; and,
 FIG. 8 is a bottom view thereof.
 The broken lines illustrate structure or features which form no part of the claimed design.

1 Claim, 8 Drawing Sheets

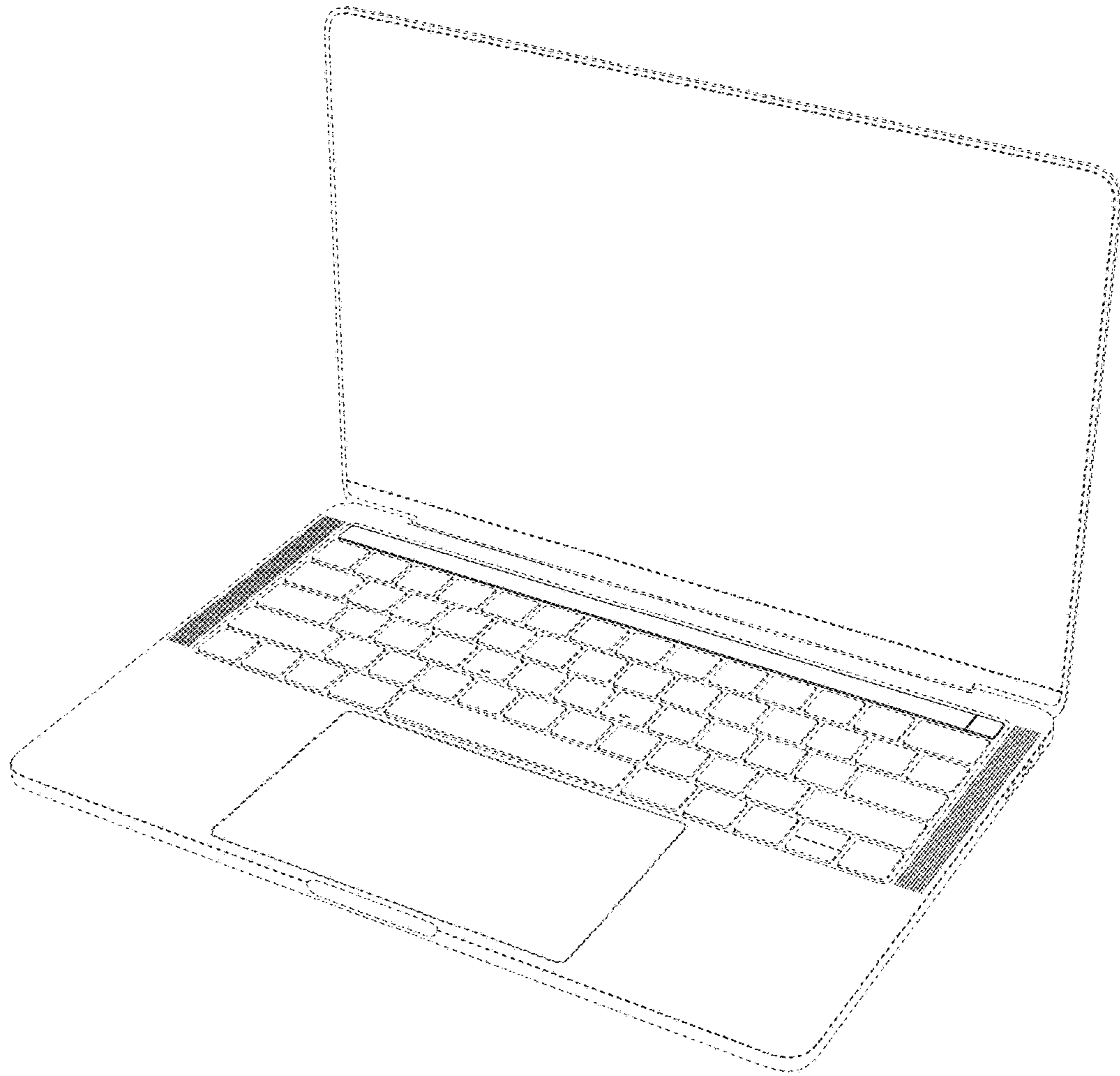

FIG. 1

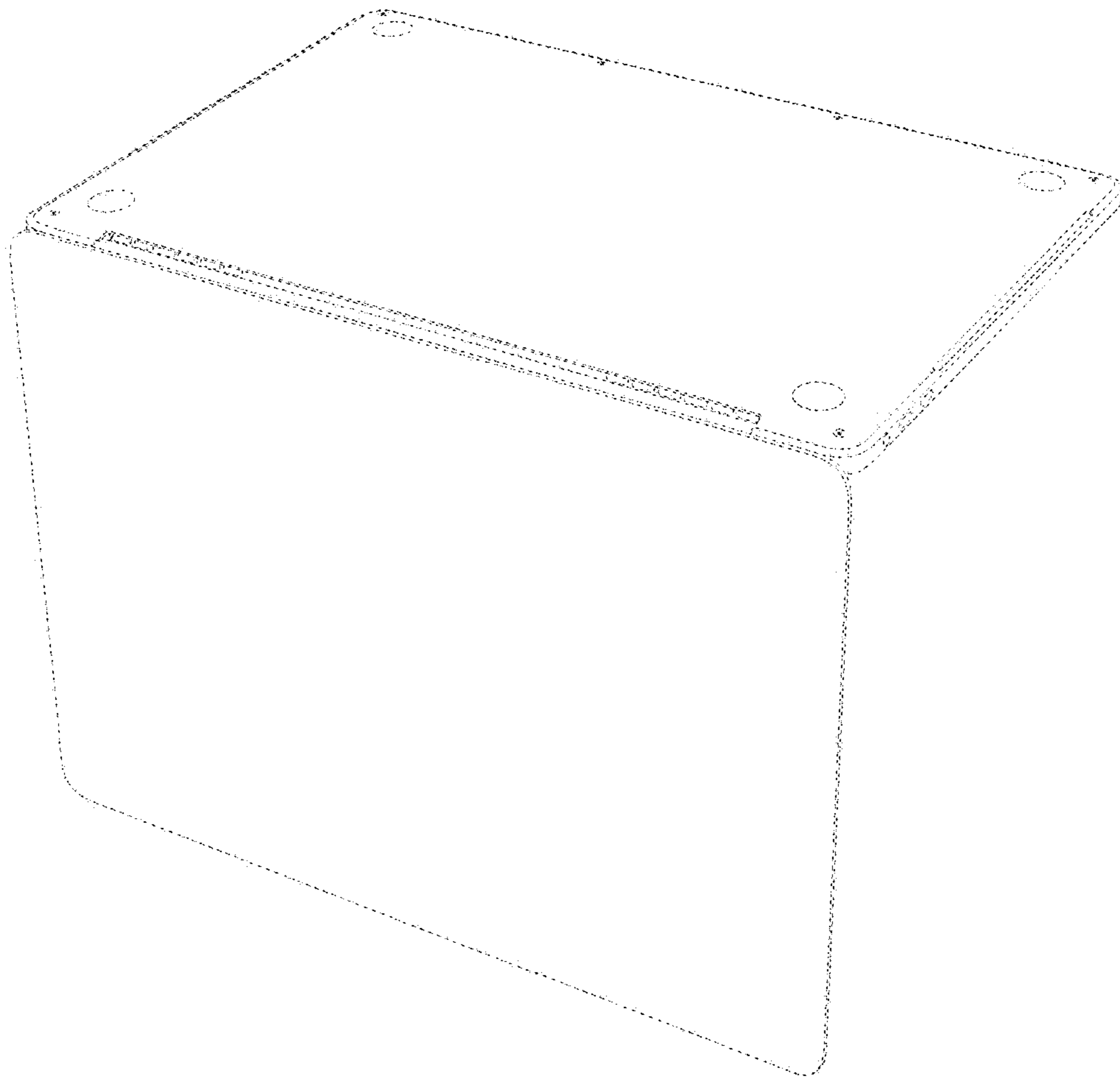

FIG. 2

FIG. 3

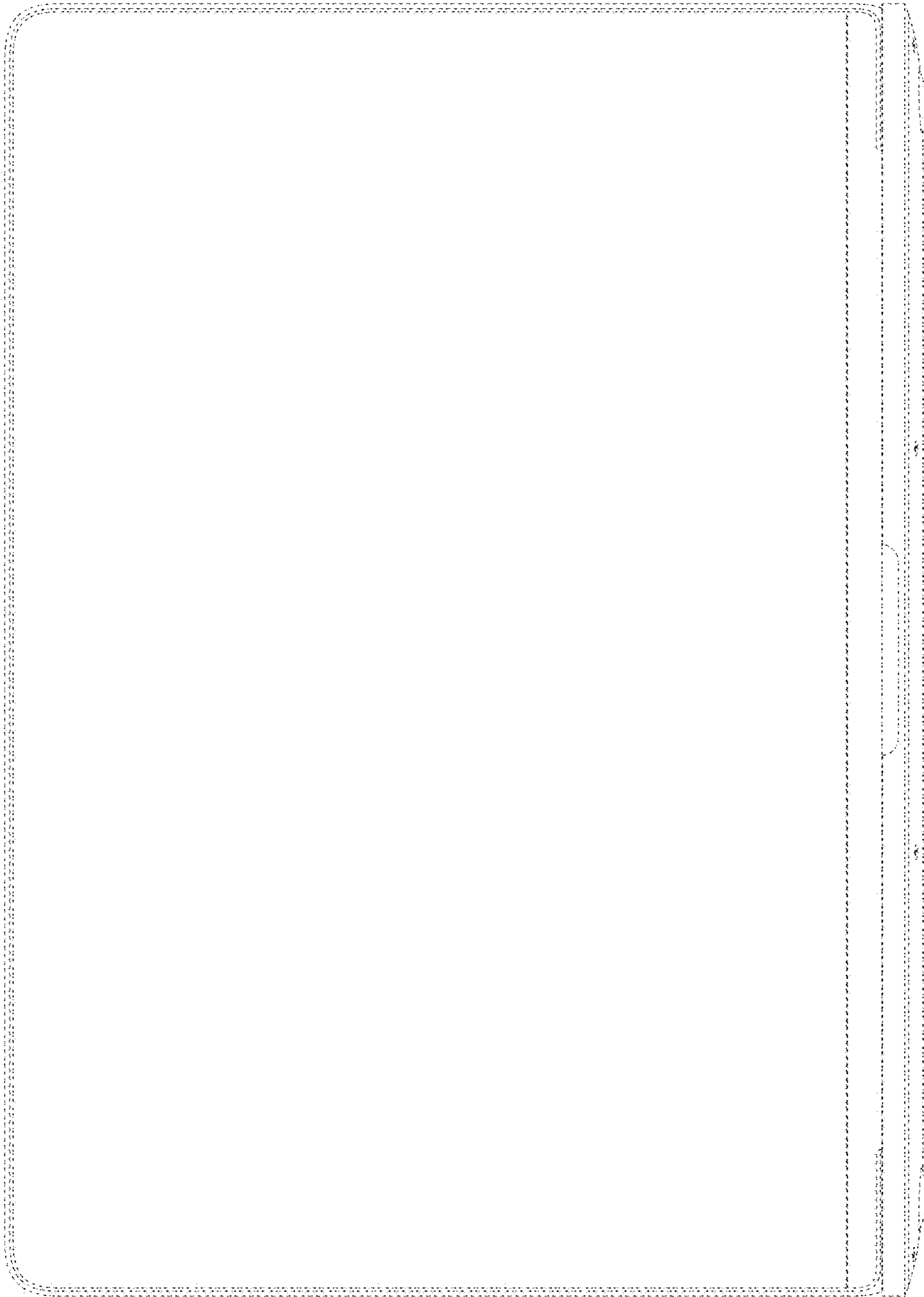
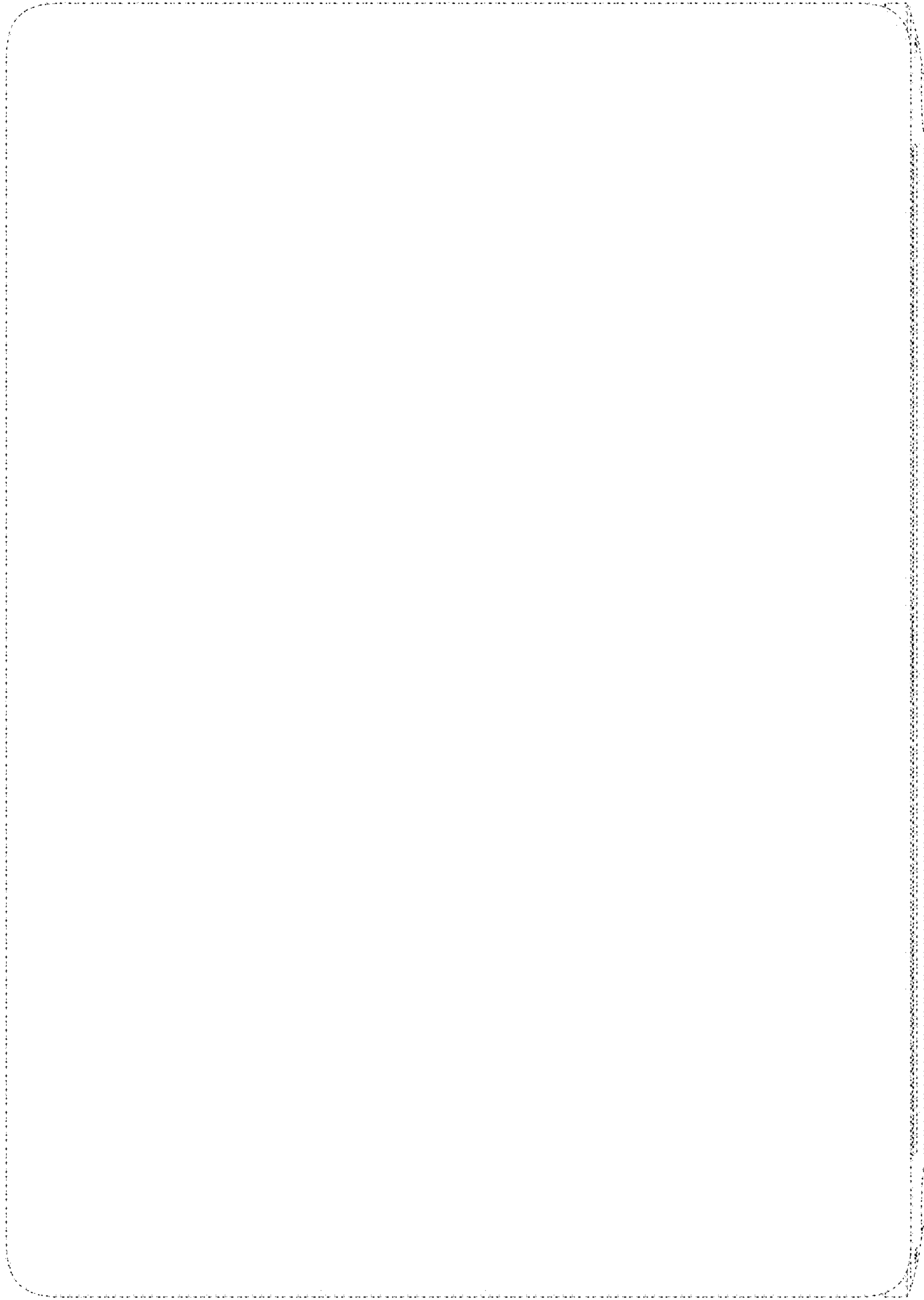

FIG. 4



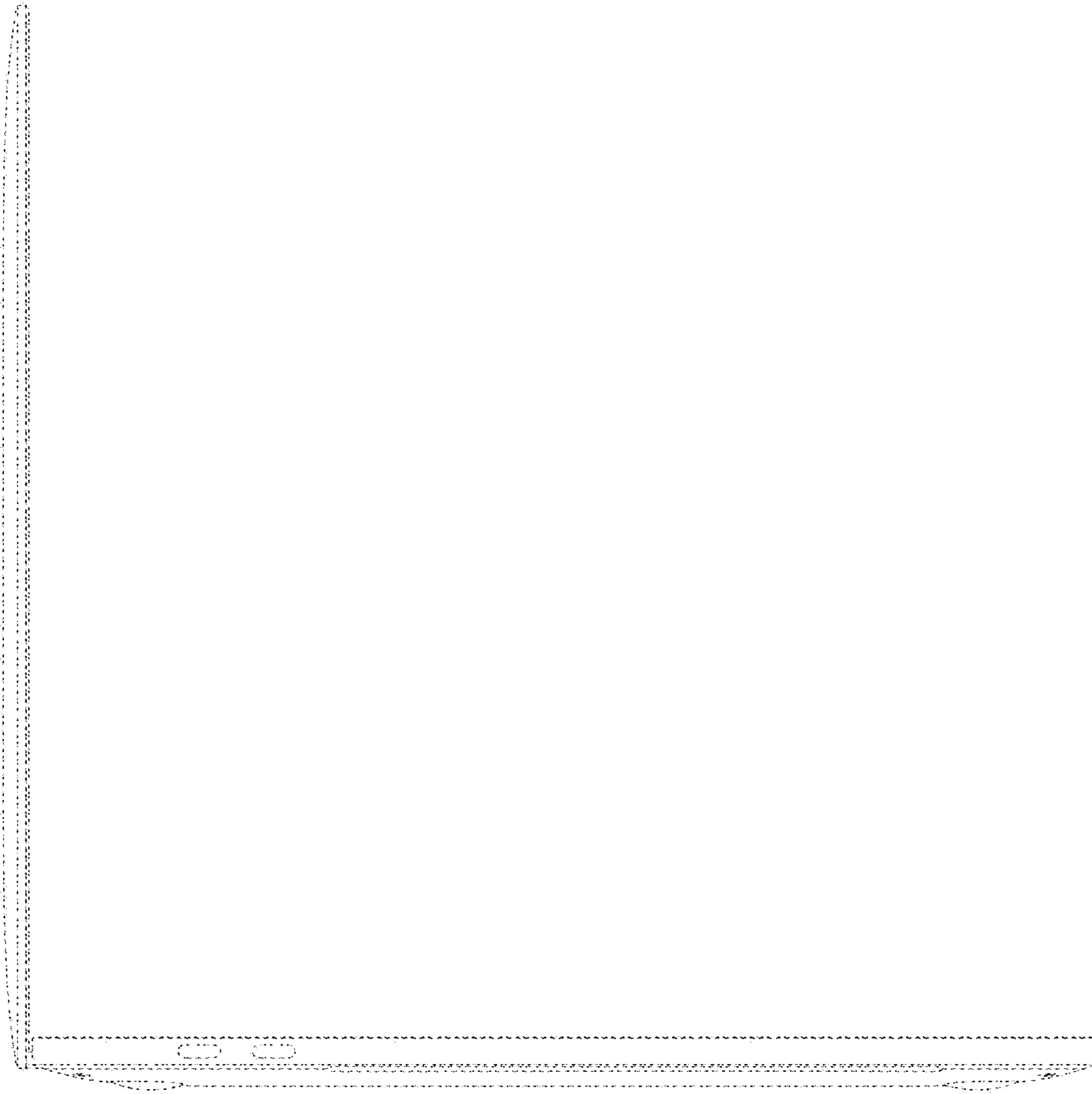

FIG. 5

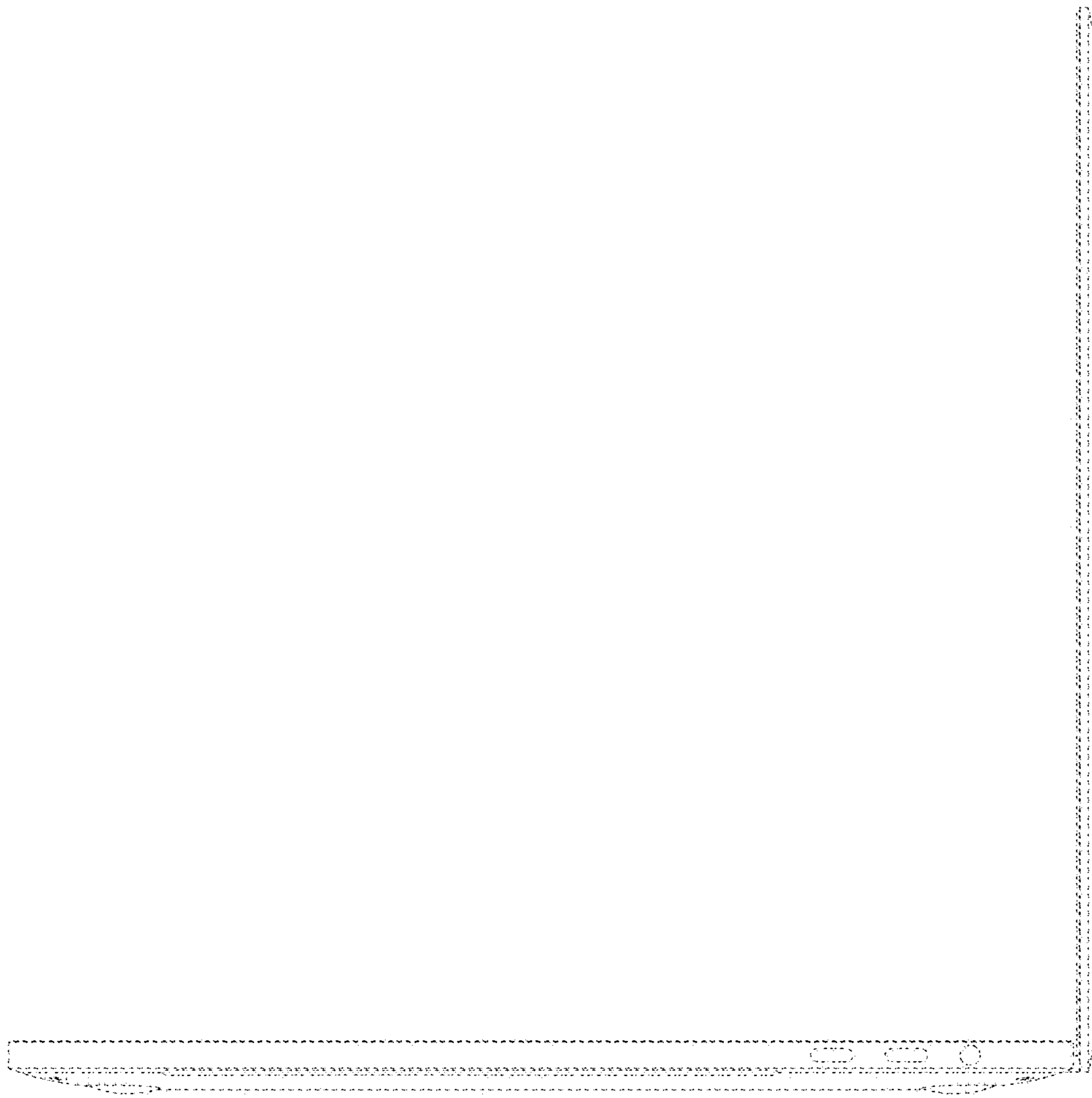

FIG. 6

FIG. 7

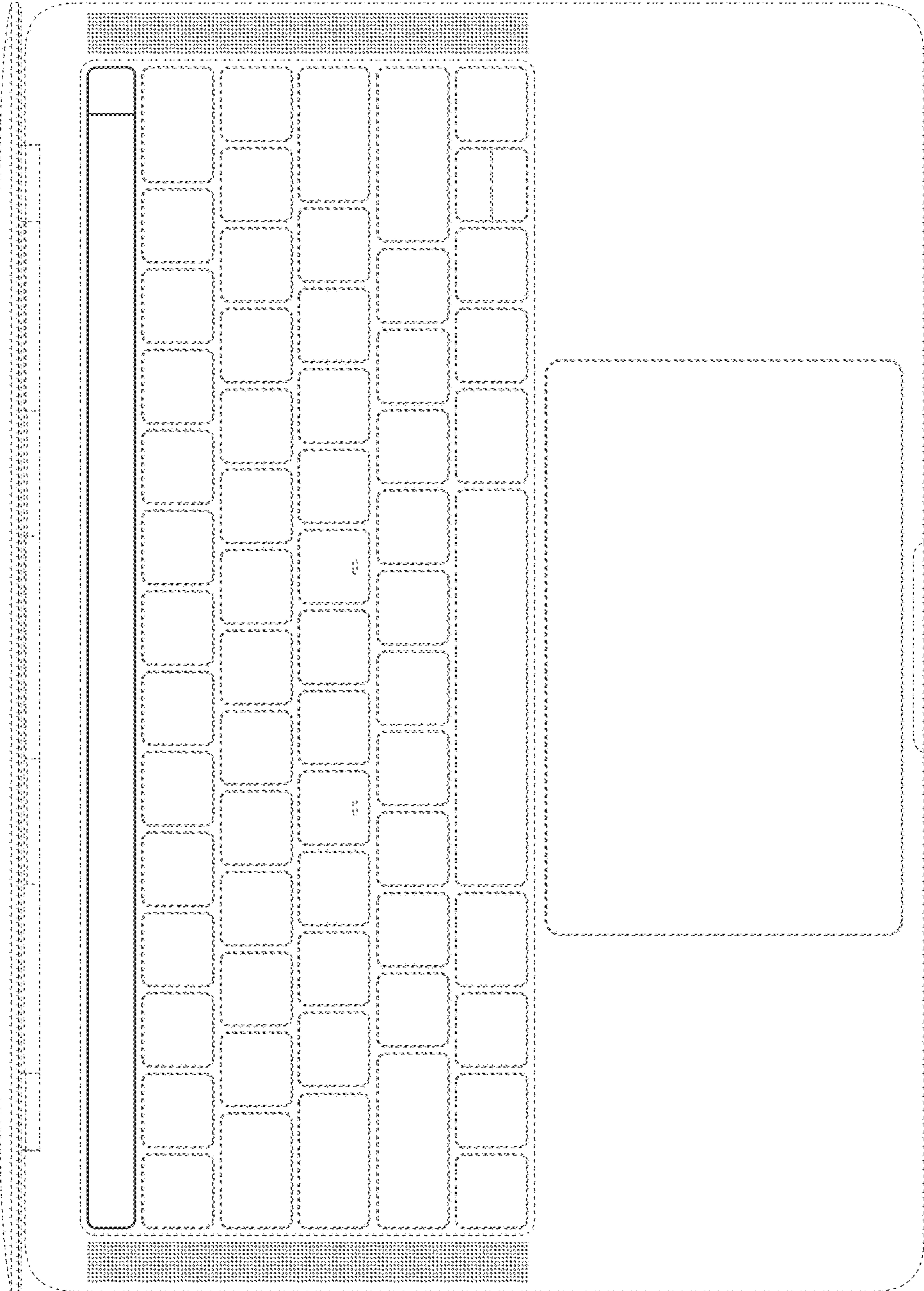

FIG. 8

