



US00D803803S

(12) **United States Design Patent**
Mori et al.

(10) **Patent No.:** **US D803,803 S**

(45) **Date of Patent:** **** Nov. 28, 2017**

(54) **FLEXIBLE PRINTED WIRING BOARD**

FOREIGN PATENT DOCUMENTS

(71) Applicant: **Sumitomo Electric Industries, Ltd.**,
Osaka (JP)

JP 1267522 S 4/2006
KR 300415642 S 6/2006

(Continued)

(72) Inventors: **Koji Mori**, Osaka (JP); **Takashi Iwasaki**, Osaka (JP); **Kazumasa Toya**, Osaka (JP); **Kenji Saito**, Osaka (JP); **Yoshiya Abiko**, Osaka (JP); **Youichi Nagai**, Osaka (JP); **Makoto Inagaki**, Osaka (JP); **Rui Mikami**, Osaka (JP)

OTHER PUBLICATIONS

Japanese Office Action for related Japanese Design Patent Application No. 2014-011387 dated Feb. 9, 2015, 2 Pages.

(Continued)

(73) Assignee: **SUMITOMO ELECTRIC INDUSTRIES, LTD.**, Osaka (JP)

Primary Examiner — Elizabeth J Oswecki

(74) *Attorney, Agent, or Firm* — Ditthavong & Steiner, P.C.

(**) Term: **15 Years**

(21) Appl. No.: **29/586,571**

(57) **CLAIM**

The ornamental design for a flexible printed wiring board, as shown and described.

(22) Filed: **Dec. 5, 2016**

Related U.S. Application Data

DESCRIPTION

(62) Division of application No. 29/507,516, filed on Oct. 28, 2014, now Pat. No. Des. 785,575.

(30) **Foreign Application Priority Data**

May 28, 2014 (JP) 2014-011387
May 28, 2014 (JP) 2014-011389

(Continued)

(51) **LOC (10) Cl.** **13-03**

(52) **U.S. Cl.**
USPC **D13/182**

(58) **Field of Classification Search**
USPC D13/155, 182; 174/68.1, 68.2, 68.3, 250, 174/253, 254, 255, 256, 257, 258, 260
(Continued)

(56) **References Cited**

U.S. PATENT DOCUMENTS

3,646,399 A 2/1972 Mars et al.
3,777,221 A 12/1973 Tatusko et al.

(Continued)

FIG. 1 is a front view of a flexible printed wiring board showing our new design;
FIG. 2 is a rear view thereof;
FIG. 3 is a top plan view thereof;
FIG. 4 is a bottom plan view thereof;
FIG. 5 is a right side view thereof;
FIG. 6 is a left side view thereof;
FIG. 7 is an enlarged top plan view of the portion taken along line 7-7 in FIG. 3;
FIG. 8 is a bottom plan view of FIG. 7;
FIG. 9 is a front view of FIG. 7;
FIG. 10 is a rear view of FIG. 7;
FIG. 11 is a right side view of FIG. 7;
FIG. 12 is a left side view of FIG. 7; and,
FIG. 13 is a perspective view of FIG. 7.
The even dashed broken lines shown in the drawings represent portions of the flexible printed wiring board that form no part of the claimed design. The dashed-dot-dashed lines indicate a boundary between the claimed and unclaimed surface areas.

1 Claim, 4 Drawing Sheets

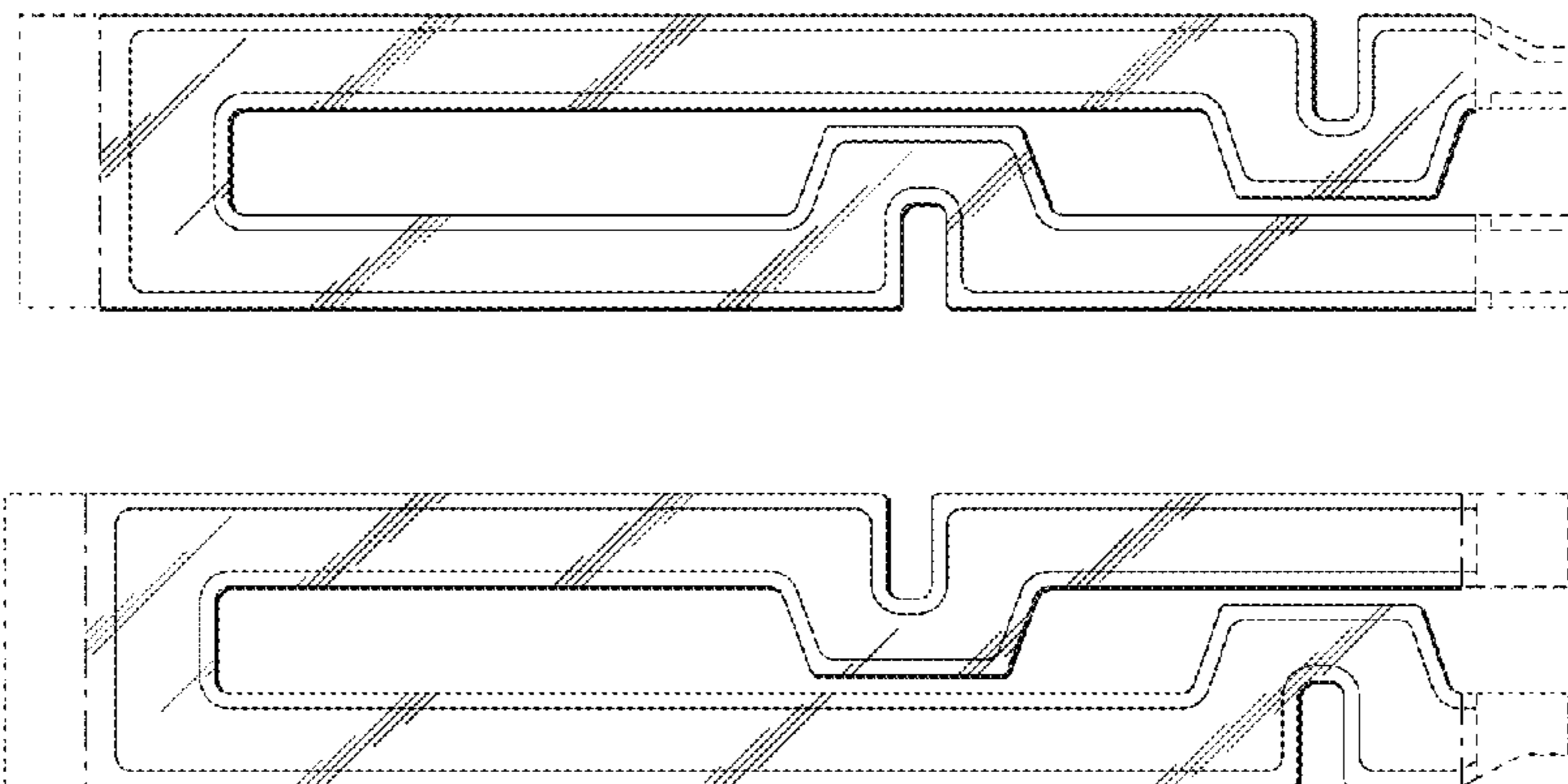

(30) Foreign Application Priority Data

May 28, 2014 (JP) 2014-011390
 May 28, 2014 (JP) 2014-011391
 May 28, 2014 (JP) 2014-011392
 May 28, 2014 (JP) 2014-011393

(58) Field of Classification Search

CPC H05K 3/36; H05K 3/361; H05K 3/363;
 H05K 3/365; H05K 3/40; H05K 3/4007;
 H05K 3/4015; H05K 3/0062; H05K 3/28;
 H05K 3/281; H05K 2201/0999; H05K
 2201/09818; H05K 2201/04; H05K
 2201/05; H05K 2201/051; H05K
 2201/052; H05K 2201/053; H05K
 2201/055; H05K 2201/056; H05K
 2201/057; H05K 2201/058; H05K
 2201/0715; H05K 1/0393; H05K 1/118;
 H05K 1/028; H05K 1/0281; H05K
 1/0283

See application file for complete search history.

(56) References Cited

U.S. PATENT DOCUMENTS

D363,920 S 11/1995 Roberts et al.
 D397,093 S 8/1998 Kim
 5,799,392 A * 9/1998 Mishiro H05K 3/361
 156/273.3
 6,324,067 B1 * 11/2001 Nishiyama H05K 1/165
 174/262
 D548,201 S 8/2007 Jones
 7,338,290 B2 * 3/2008 Motohashi H05K 1/117
 439/55
 D601,520 S 10/2009 Yokota et al.
 7,616,452 B2 11/2009 Wehrly, Jr. et al.
 D605,613 S 12/2009 Carter et al.
 7,660,126 B2 2/2010 Cho et al.
 D612,347 S 3/2010 Yokota et al.
 D615,506 S 5/2010 Eide et al.
 D637,566 S 5/2011 Cleghorn et al.
 8,035,983 B2 * 10/2011 Takahashi H05K 3/4691
 174/255
 D656,111 S 3/2012 Kajiya et al.
 D656,112 S 3/2012 Kajiya et al.
 D661,265 S 6/2012 Kajiya et al.
 8,238,109 B2 * 8/2012 Sagisaka H05K 3/4691
 174/254
 D669,045 S 10/2012 Kajiya et al.
 D669,046 S 10/2012 Kajiya et al.

D687,397 S 8/2013 Kajiya et al.
 D757,666 S 5/2016 Yokoo
 D784,936 S * 4/2017 Mori D13/182
 2005/0243528 A1 * 11/2005 Murayama H05K 1/148
 361/760
 2006/0169485 A1 * 8/2006 Kawaguchi H05K 3/4691
 174/254
 2006/0281343 A1 * 12/2006 Uchida H05K 3/363
 439/67
 2007/0012475 A1 * 1/2007 Kawaguchi H05K 3/361
 174/255
 2007/0126123 A1 * 6/2007 Sawachi H05K 1/0212
 257/777
 2007/0281505 A1 * 12/2007 Kobayashi H05K 3/4691
 439/69
 2008/0014768 A1 * 1/2008 Lee H05K 3/429
 439/77
 2008/0093118 A1 * 4/2008 Takahashi H05K 3/4691
 174/264
 2008/0099230 A1 * 5/2008 Takahashi H05K 3/4691
 174/250
 2008/0289859 A1 * 11/2008 Mikado H05K 1/0281
 174/254
 2009/0229876 A1 * 9/2009 Takahashi H05K 3/4691
 174/378
 2009/0255111 A1 * 10/2009 Takahashi H05K 1/115
 29/852

FOREIGN PATENT DOCUMENTS

KR 300681061 S 3/2013
 TW D159654 S 4/2014
 TW D160046 S 4/2014

OTHER PUBLICATIONS

Japanese Office Action for related Japanese Patent Application No. 2014-011389 dated Feb. 9, 2015, 2 Pages.
 Japanese Office Action for related Japanese Patent Application No. 2014-011390 dated Feb. 9, 2015, 2 Pages.
 Japanese Office Action for related Japanese Patent Application No. 2014-011391 dated Feb. 9, 2015, 2 Pages.
 Japanese Office Action for related Japanese Patent Application No. 2014-011392 dated Feb. 9, 2015, 2 Pages.
 Japanese Office Action for related Japanese Patent Application No. 2014-011393 dated Feb. 9, 2015, 2 Pages.
 Japanese Office Action for related Japanese Design Patent Application No. 2014-011388 dated Jul. 6, 2015, 2 Pages.
 Oki Electric Cable, "Oki Electric Cable Develops Industry's First FPC for Three-dimension Wiring", Jun. 11, 2008, 5 Pages.

* cited by examiner

FIG.1



FIG.2

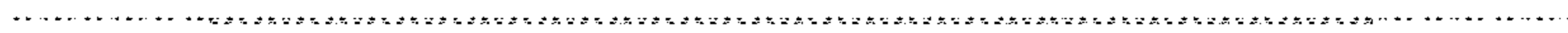

FIG.3



FIG.4

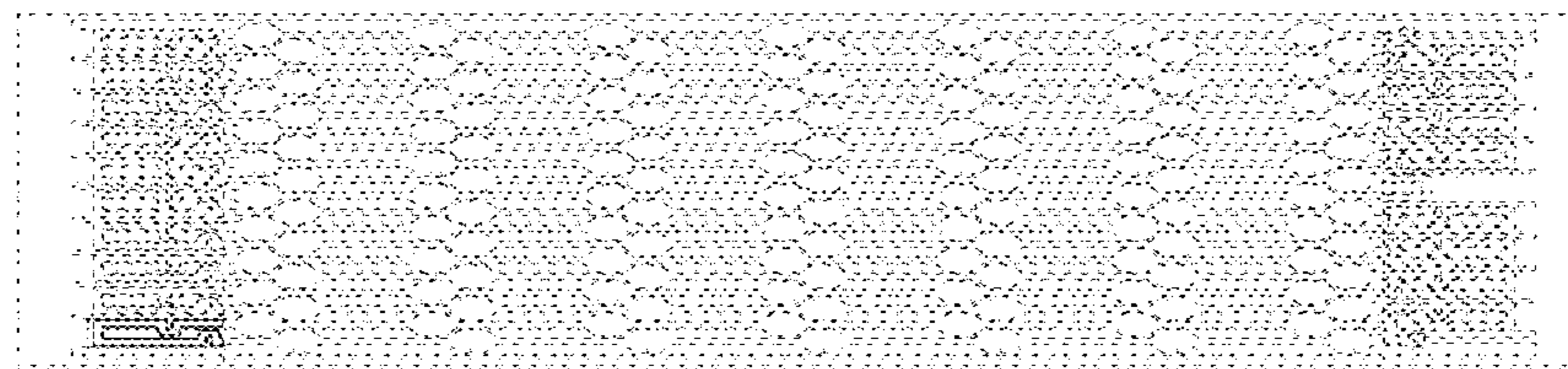

FIG.5

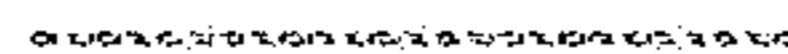

FIG.6



FIG.7

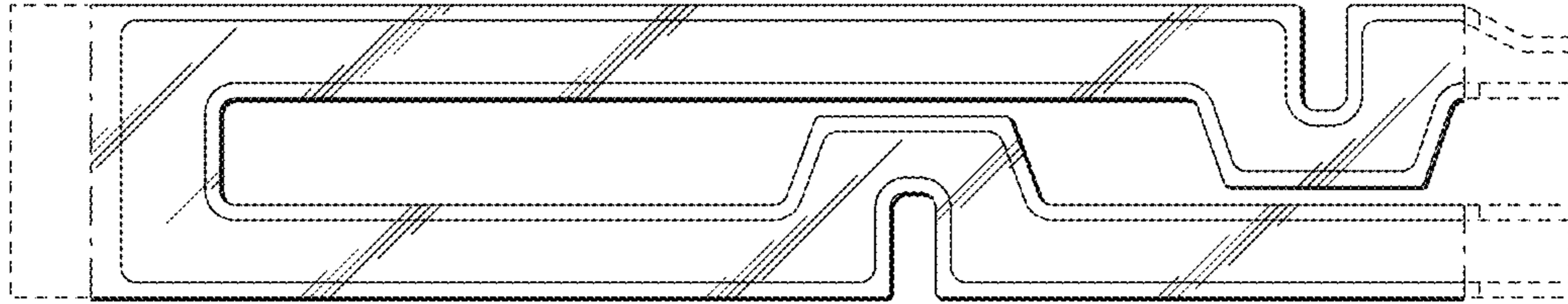

FIG.8

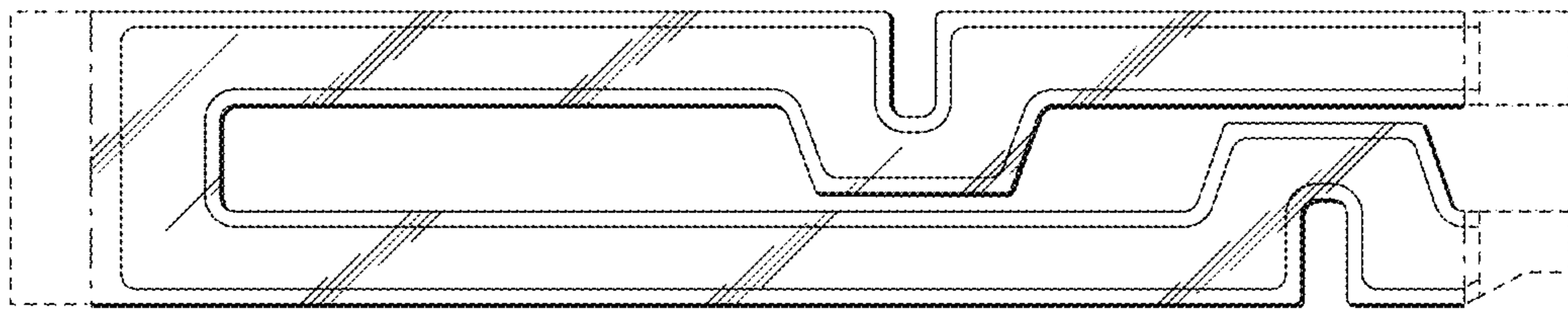

FIG.9



FIG.10



FIG.11

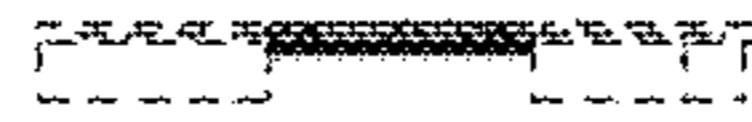

FIG.12

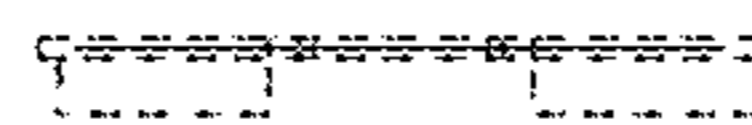

FIG.13

