



US00D803793S

(12) **United States Design Patent** (10) **Patent No.:** **US D803,793 S**
Jacoby et al. (45) **Date of Patent:** **** *Nov. 28, 2017**

(54) **CONTROL DEVICE**

- (71) Applicant: **Lutron Electronics Co., Inc.**,
Coopersburg, PA (US)
- (72) Inventors: **Elliot G. Jacoby**, Glenside, PA (US);
Jason C. Killo, Emmaus, PA (US);
Brad Michael Kreschollek, Bethlehem,
PA (US)
- (73) Assignee: **Lutron Electronics Co., Inc.**,
Coopersburg, PA (US)
- (*) Notice: This patent is subject to a terminal dis-
claimer.
- (**) Term: **15 Years**
- (21) Appl. No.: **29/573,458**
- (22) Filed: **Aug. 5, 2016**

Related U.S. Application Data

- (63) Continuation of application No. 29/502,412, filed on
Sep. 16, 2014, now Pat. No. Des. 768,582.
- (51) **LOC (10) Cl.** **13-03**
- (52) **U.S. Cl.**
USPC **D13/171; D13/164**
- (58) **Field of Classification Search**
USPC **D13/162, 164, 171, 177**
(Continued)

(56) **References Cited**

U.S. PATENT DOCUMENTS

- D453,742 S 2/2002 Butler et al.
 - D465,460 S 11/2002 Mayo et al.
- (Continued)

FOREIGN PATENT DOCUMENTS

- CA 123790 S 6/2009

OTHER PUBLICATIONS

U.S. Appl. No. 29/502,399, filed Sep. 16, 2014 (unpublished).
(Continued)

Primary Examiner — Selina Sikder
(74) *Attorney, Agent, or Firm* — Saidman DesignLaw
Group, LLC

(57) **CLAIM**

We claim the ornamental design for a control device, as
shown and described.

DESCRIPTION

FIG. 1 is a perspective view of a control device according to a first embodiment of our new design.
 FIG. 2 is a front view thereof.
 FIG. 3 is a left side view thereof.
 FIG. 4 is a right side view thereof.
 FIG. 5 is a top view thereof.
 FIG. 6 is a bottom view thereof.
 FIG. 7 is a perspective view of a control device according to a second embodiment of our new design.
 FIG. 8 is a front view thereof, the left side, right side, top, and bottom views, respectively, of the second embodiment being identical to the left side, right side, top, and bottom views of the first embodiment.
 FIG. 9 is a perspective view of a control device according to a third embodiment of our new design.
 FIG. 10 is a front view thereof.
 FIG. 11 is a left side view thereof.
 FIG. 12 is a right side view thereof.
 FIG. 13 is a top view thereof.
 FIG. 14 is a bottom view thereof.
 FIG. 15 is a perspective view of a control device according to a fourth embodiment of our new design; and,
 FIG. 16 is a front view thereof, the left side, right side, top, and bottom views, respectively, of the fourth embodiment being identical to the left side, right side, top, and bottom views of the third embodiment.
 The rear views form no part of the design and are omitted. The oblique shade lines shown in the drawings indicate a transparent or translucent surface. The portions of the draw-

(Continued)

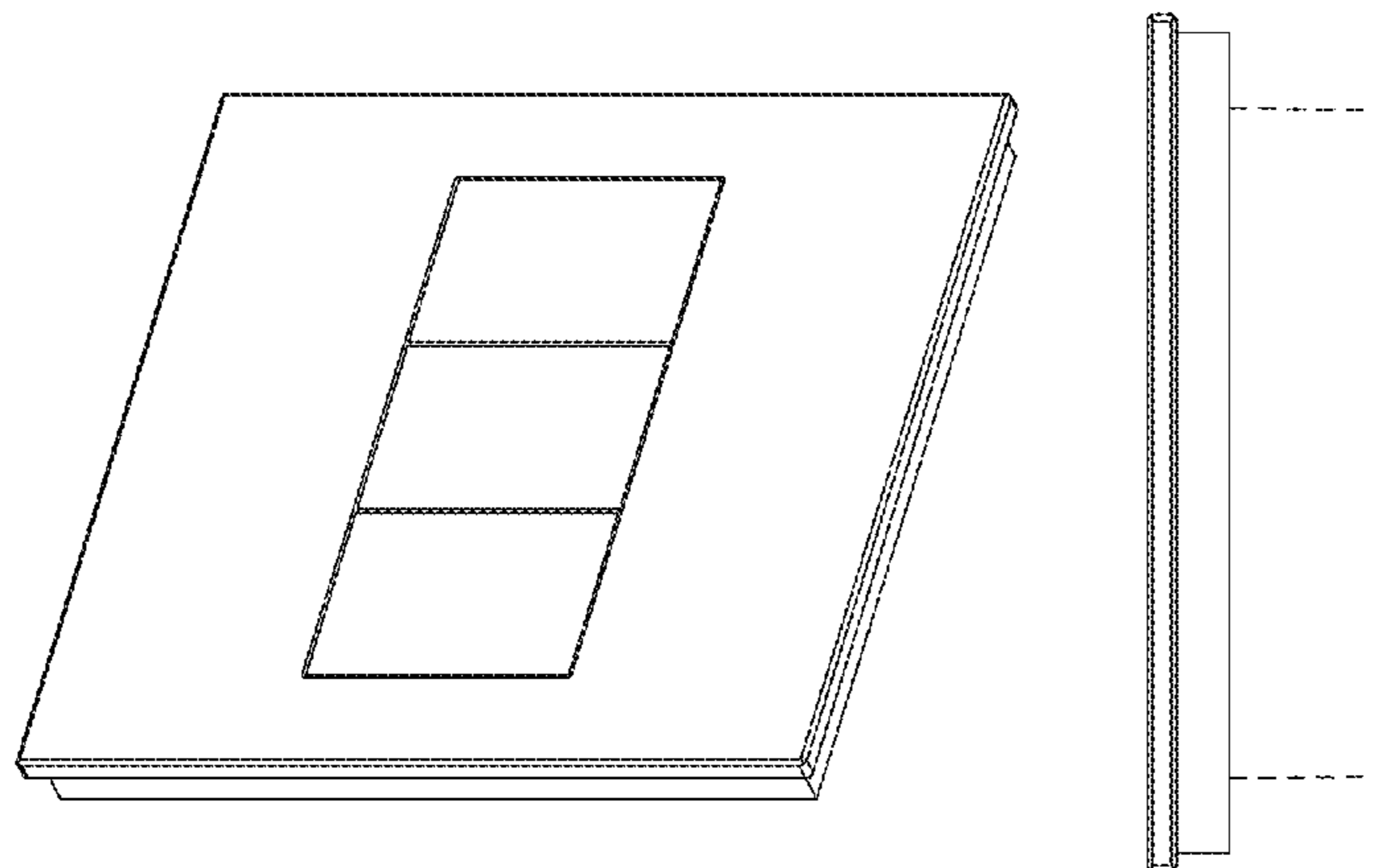

ings appearing in broken lines are for environment only and do not form part of the claimed design.

1 Claim, 12 Drawing Sheets

(58) **Field of Classification Search**

CPC .. H01H 3/12; H01H 9/02; H01H 9/16; H01H 9/18; H01H 9/181; H01H 9/182; H01H 13/04; H01H 13/14; H01H 2009/187; H05B 33/0803; H05B 33/0863; H05B 37/02; H05B 37/0254; H05B 37/0272; H05B 39/02; H05B 39/04; H05B 39/085; H05B 39/086; H05B 39/088

See application file for complete search history.

(56) **References Cited**

U.S. PATENT DOCUMENTS

D573,956 S	7/2008	Hollner et al.
D631,854 S	2/2011	Blair et al.
D638,375 S	5/2011	Clymer et al.
D649,123 S	11/2011	Jacoby et al.
D649,124 S	11/2011	Jacoby et al.
D649,520 S	11/2011	Jacoby et al.
D666,978 S	9/2012	Felegy, Jr. et al.
D673,510 S	1/2013	Felegy et al.
D694,196 S	11/2013	Felegy, Jr. et al.

D694,716 S	12/2013	Felegy, Jr. et al.	
D706,731 S	6/2014	Altonen et al.	
D706,732 S	6/2014	Altonen et al.	
D707,191 S	6/2014	Altonen et al.	
D714,234 S	9/2014	Altonen et al.	
D714,736 S	10/2014	O'Donnell	
D720,306 S	12/2014	Altonen et al.	
D733,076 S	6/2015	Jacoby et al.	
D734,277 S	7/2015	Jacoby et al.	
D767,513 S	* 9/2016	Jacoby	D13/164
D768,582 S	* 10/2016	Jacoby	D13/164
2014/0268630 A1	9/2014	Samuels	

OTHER PUBLICATIONS

Lutron Electronics Co., Inc., Stanza Hotel Guestroom Light Control Brochure, Feb. 20, 2008, 12 pages.
 Lightolier, Specification Sheet for iGen DALI 4-Button Scene Controller Model No. DA-WS4SS-7, 2007, 2 pages.
 Vantage Controls Inc., Vantage Online Binder, 2004, pp. 1, 3-4, 7, 33-34, 113.
 Dynalite Intelligent Light Pty Ltd., Light News, Aug. 2005, 8 pages, issue 2.
 INNCOM, GS0700 Family Glass Series Switches Sell Sheet, Nov. 2008, 2 pages.
 Lutron Electronics Co., Inc., Faceplate for Pico Wireless Controller Installation Sheet, Mar. 31, 2010, 2 sheets.
 Basalte BVBA, Sentido KNX v3.1 Manual, 2012, pp. 1-3.
 Bticino Spa, Matix Brochure, May 2009, 16 pages.

* cited by examiner

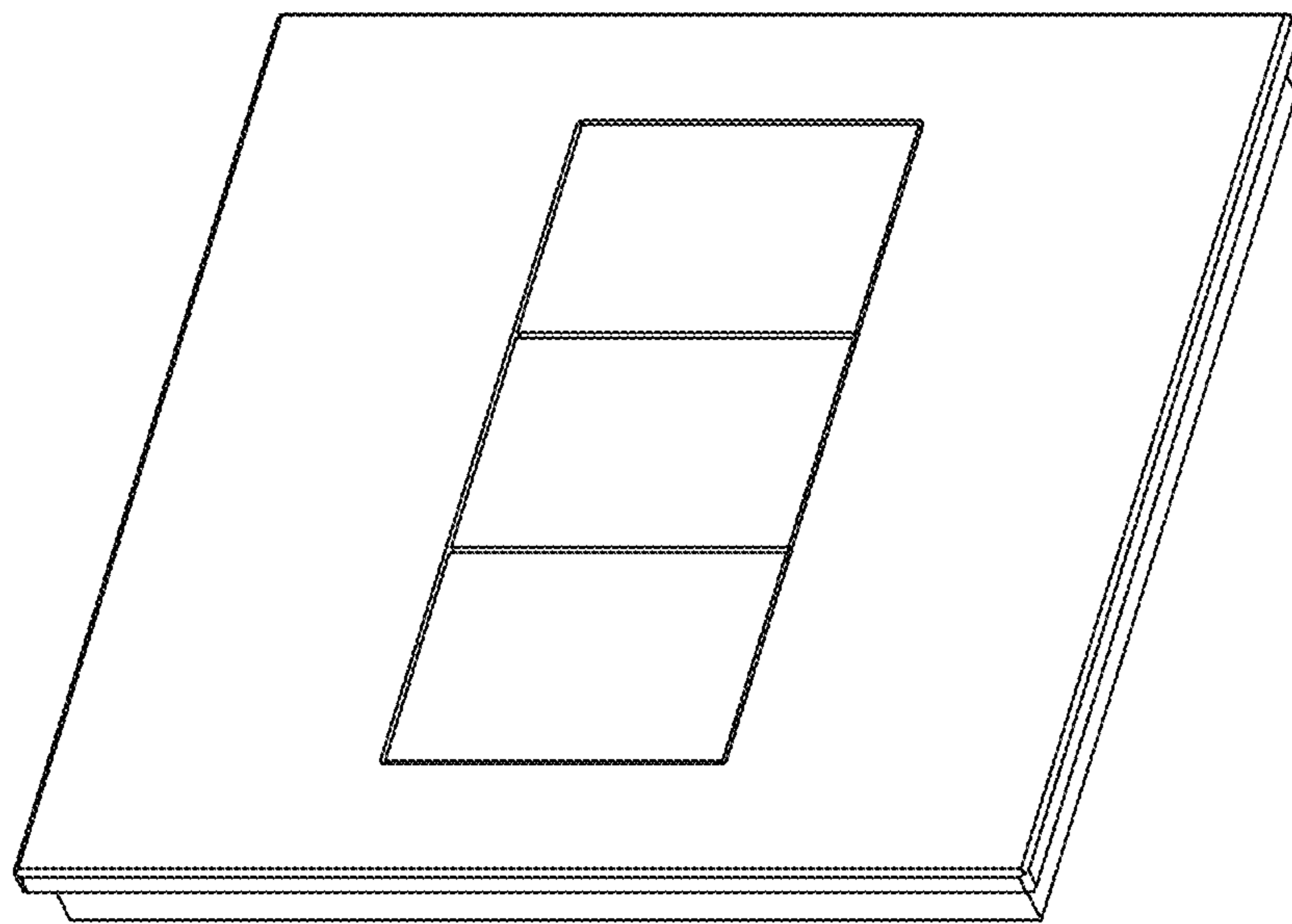

Fig. 1

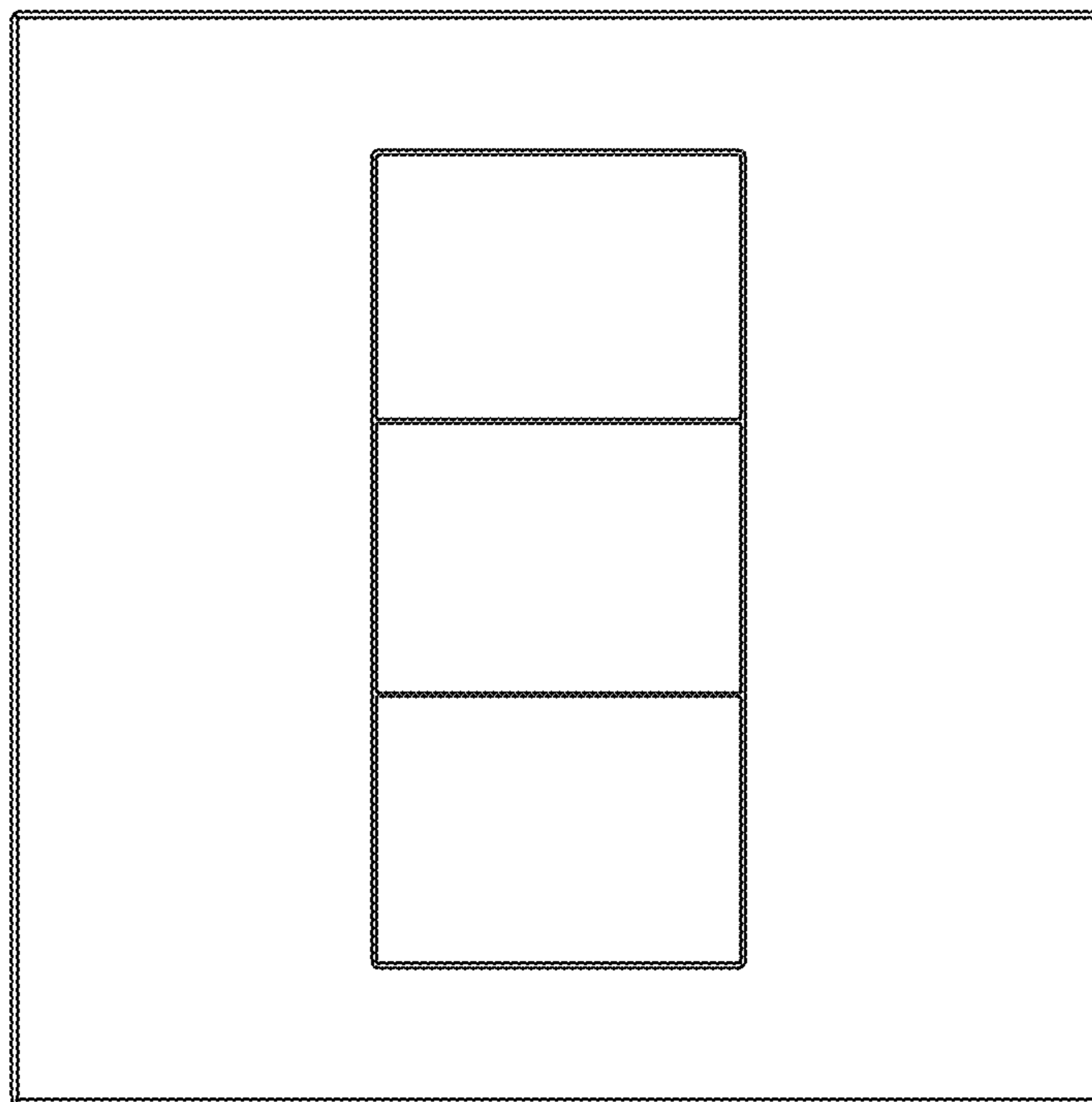

Fig. 2

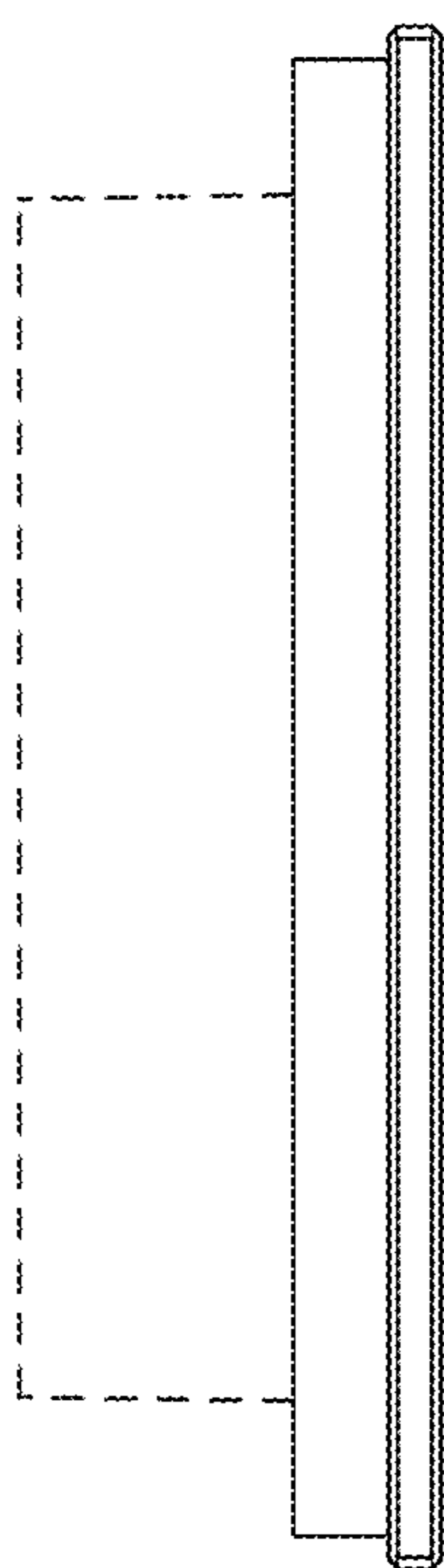

Fig. 3

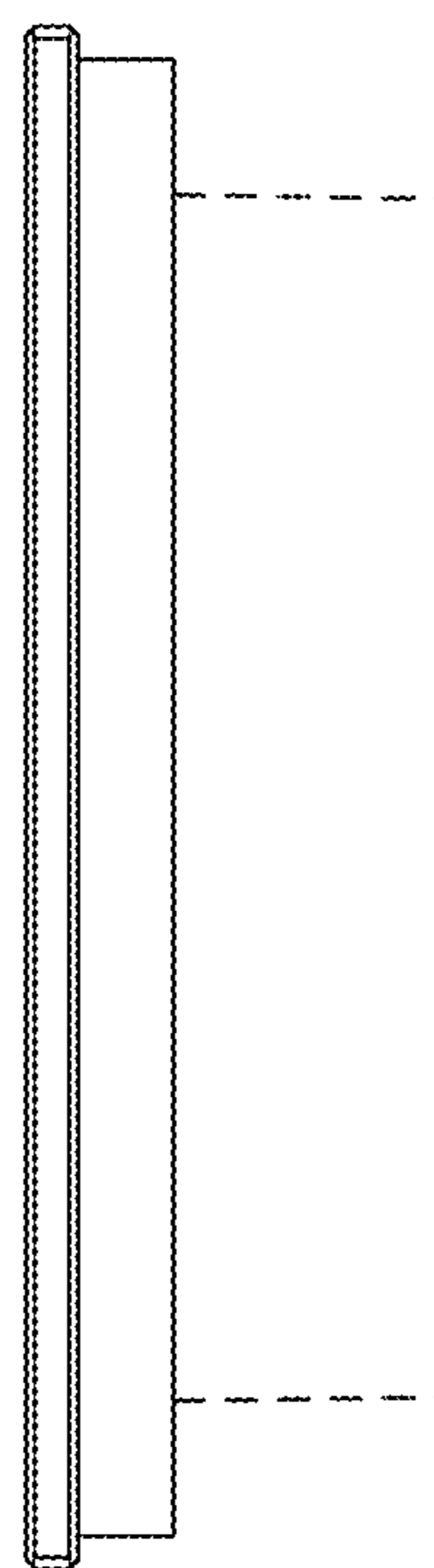

Fig. 4

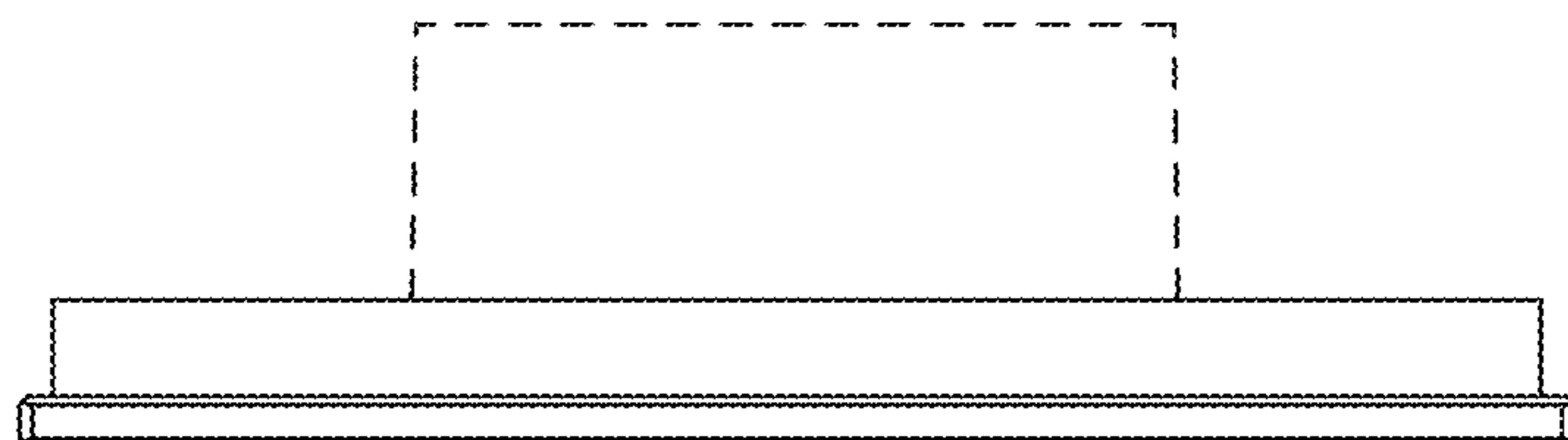

Fig. 5

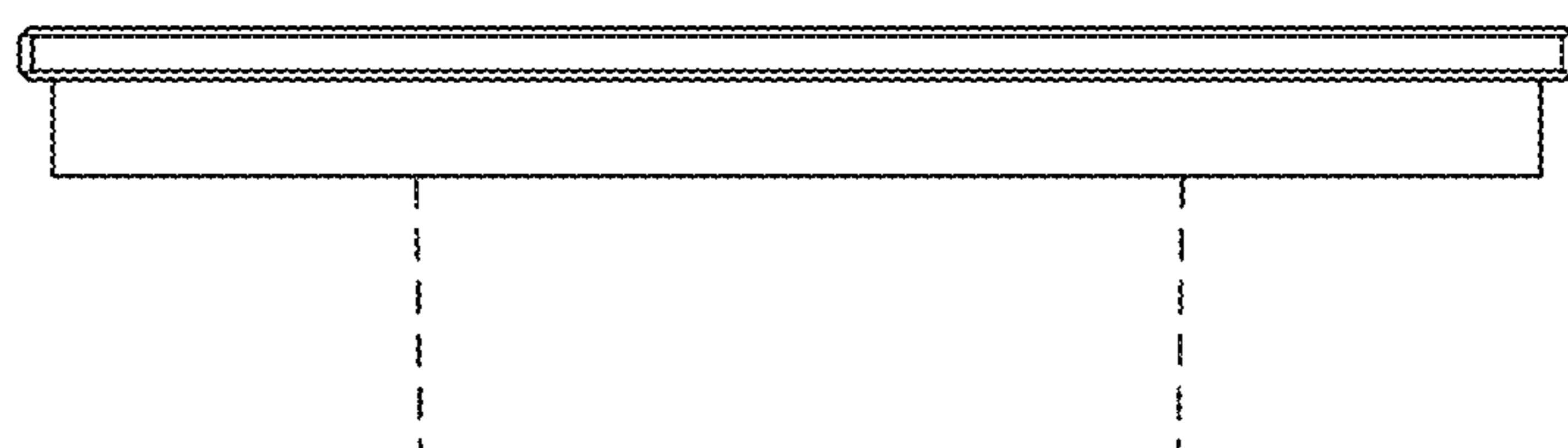

Fig. 6

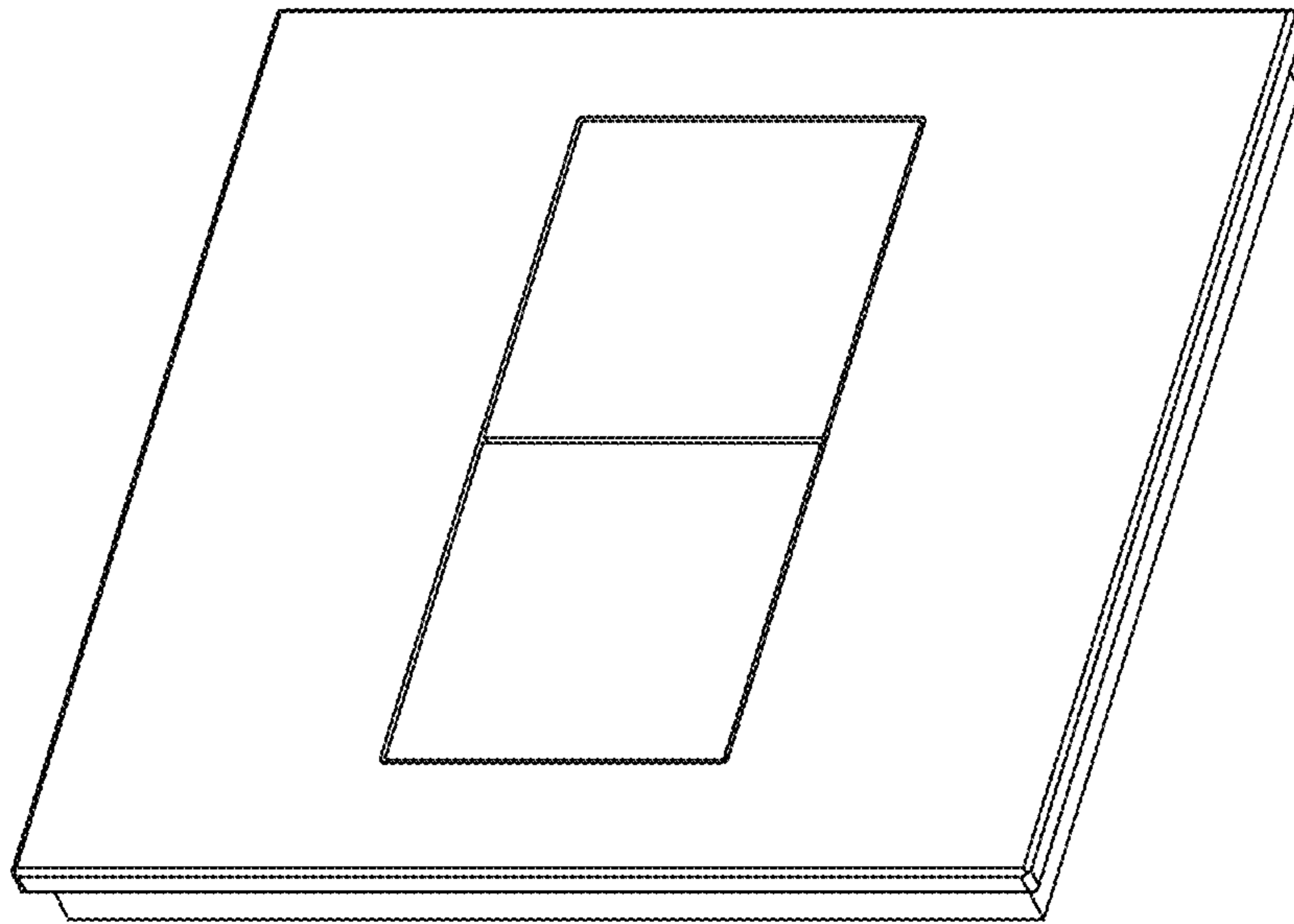

Fig. 7

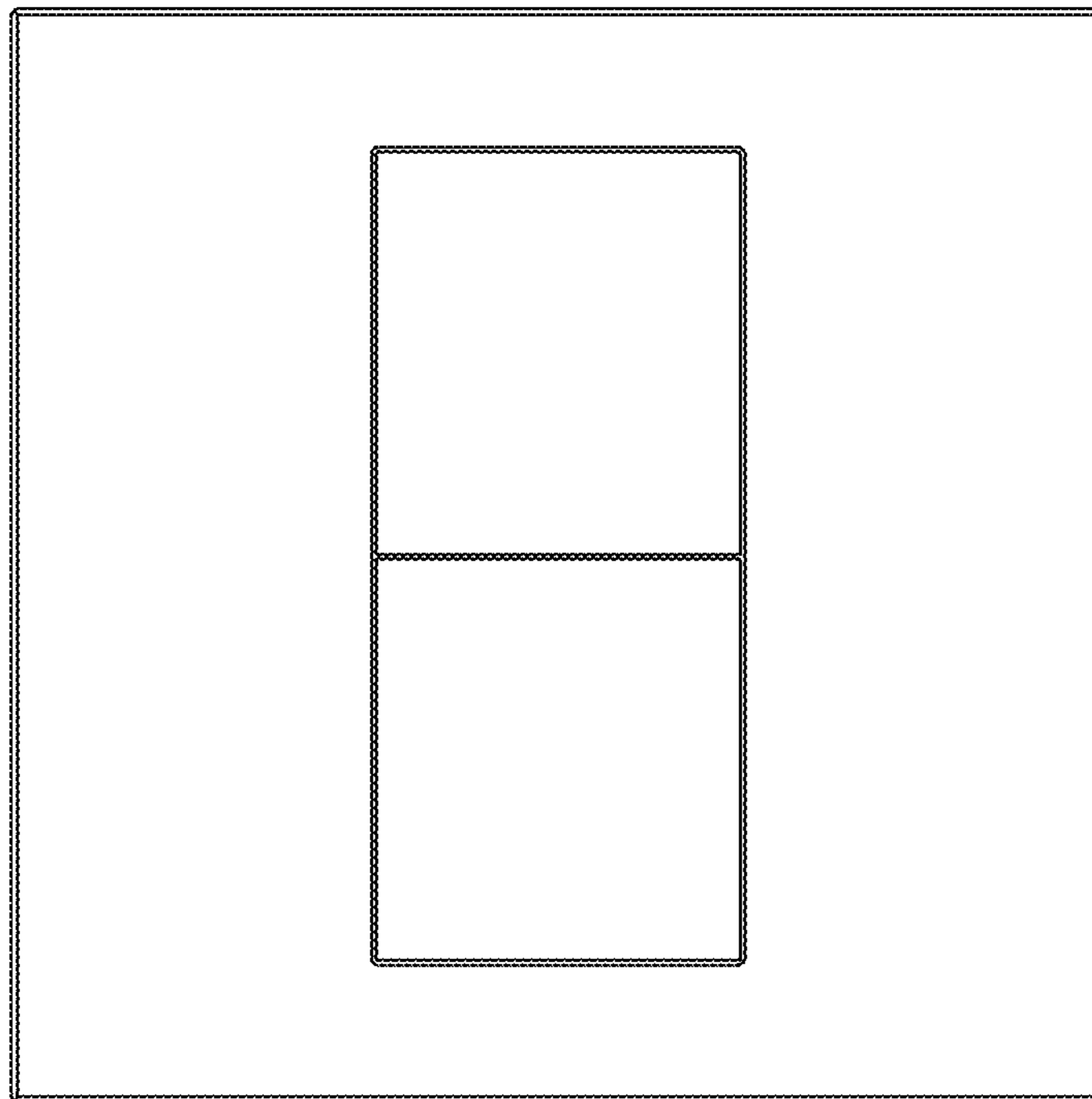

Fig. 8

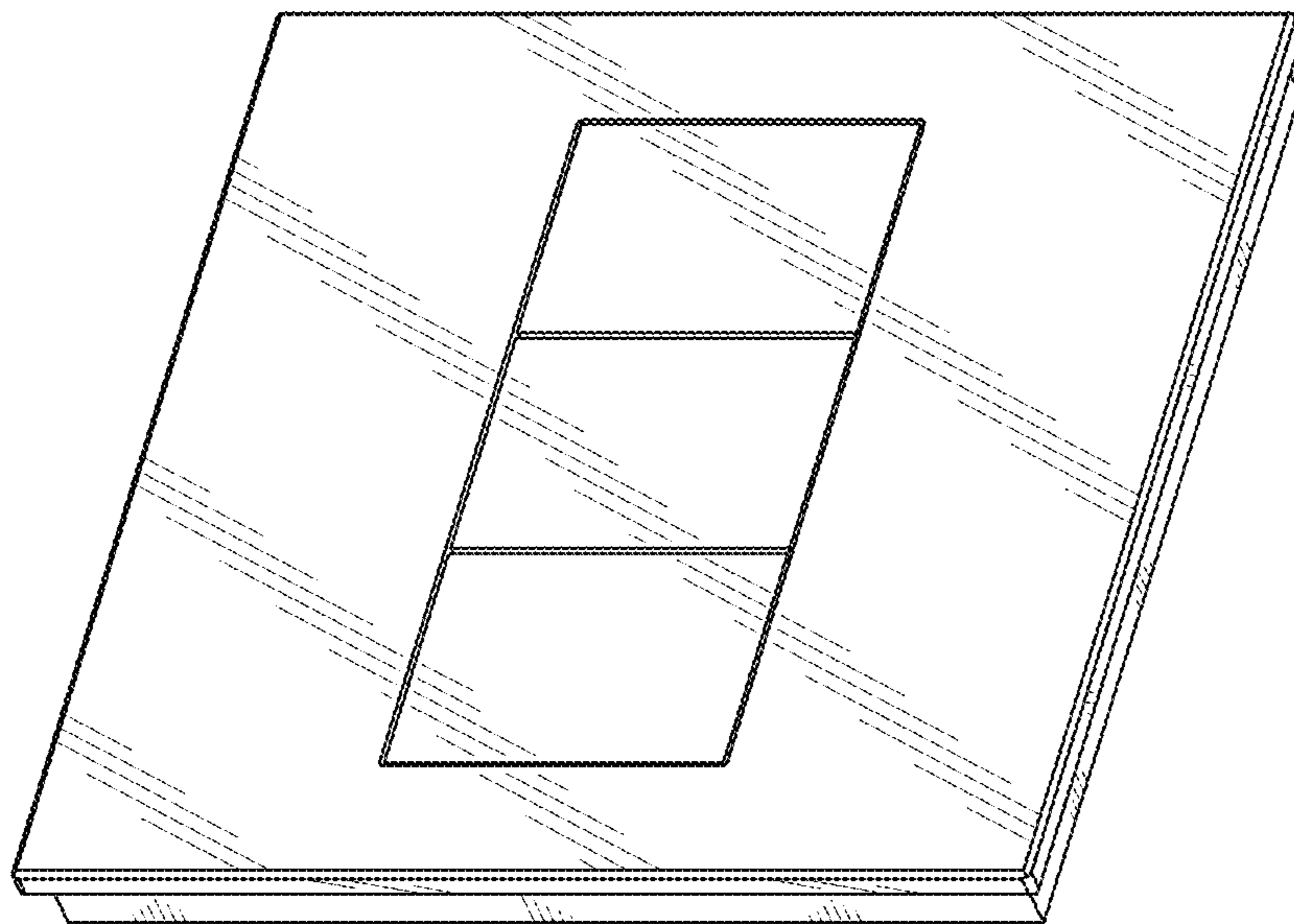

Fig. 9

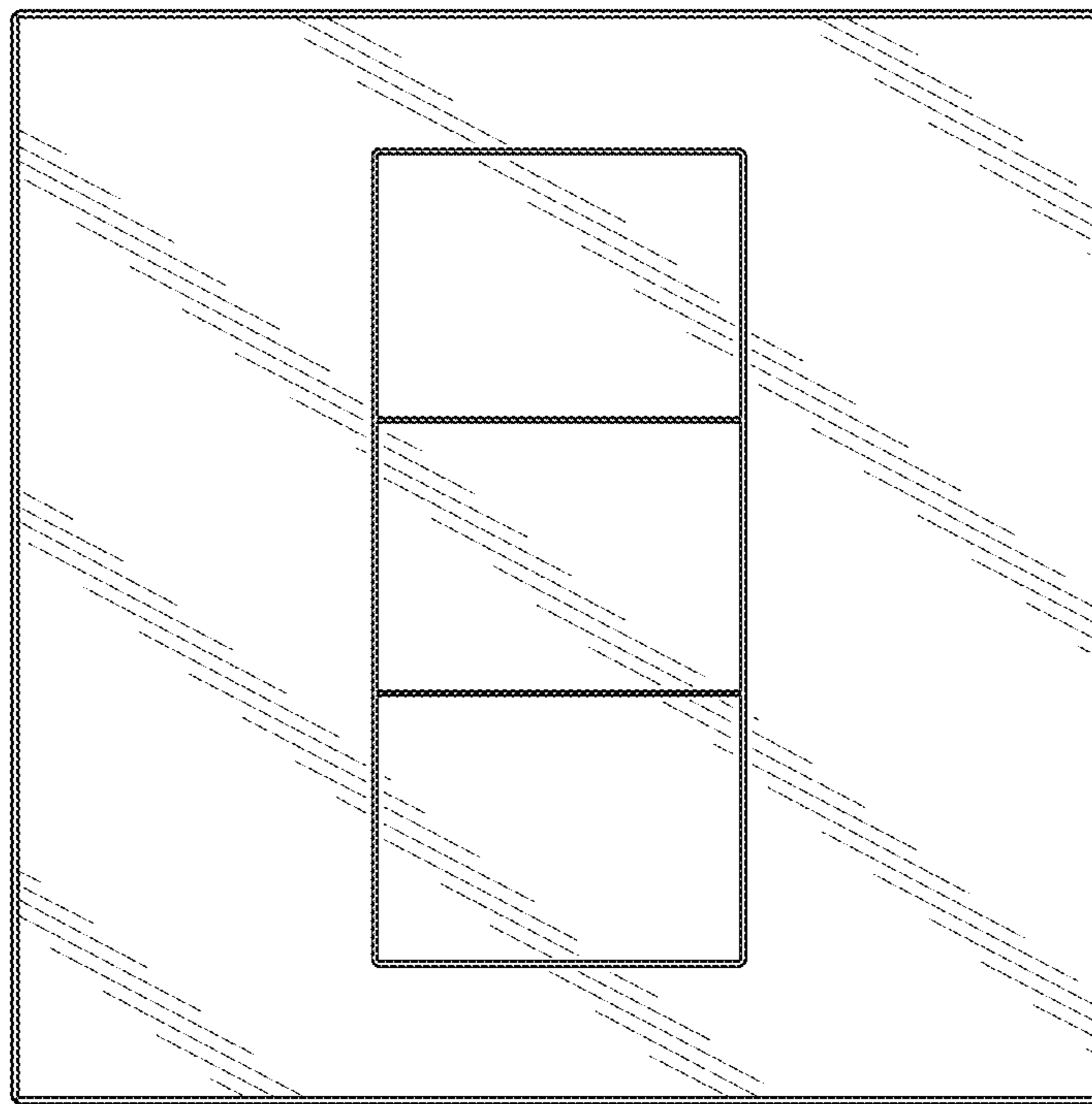

Fig. 10

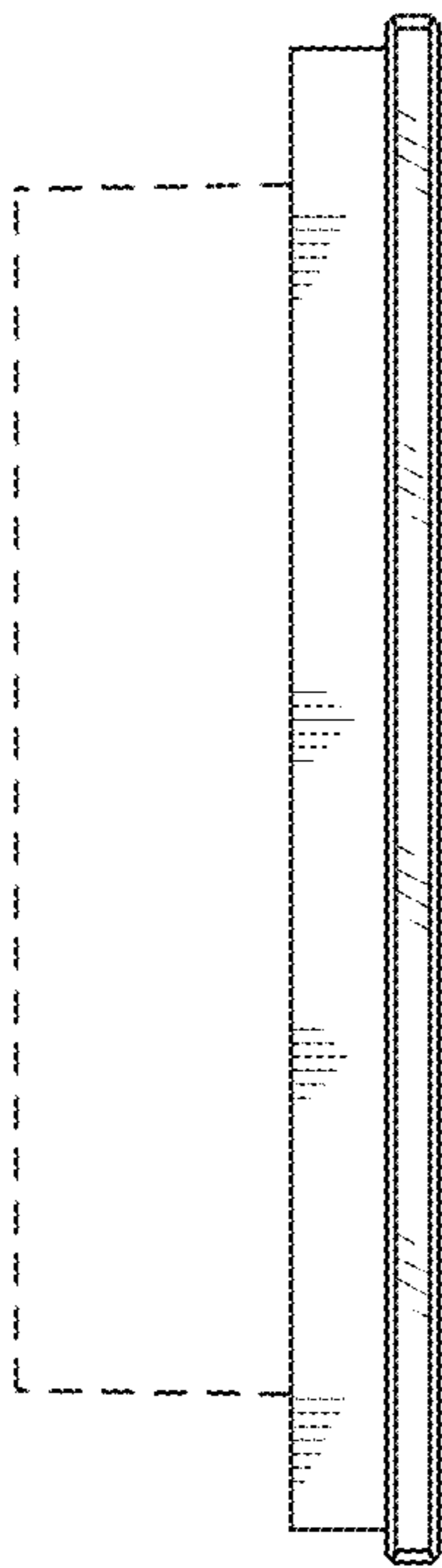

Fig. 11

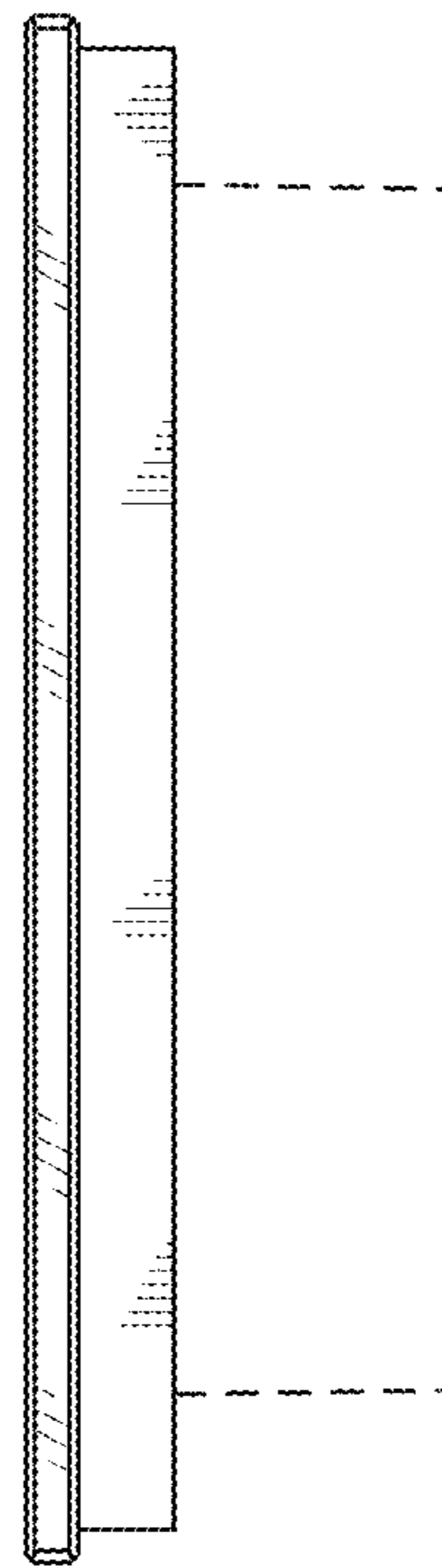

Fig. 12

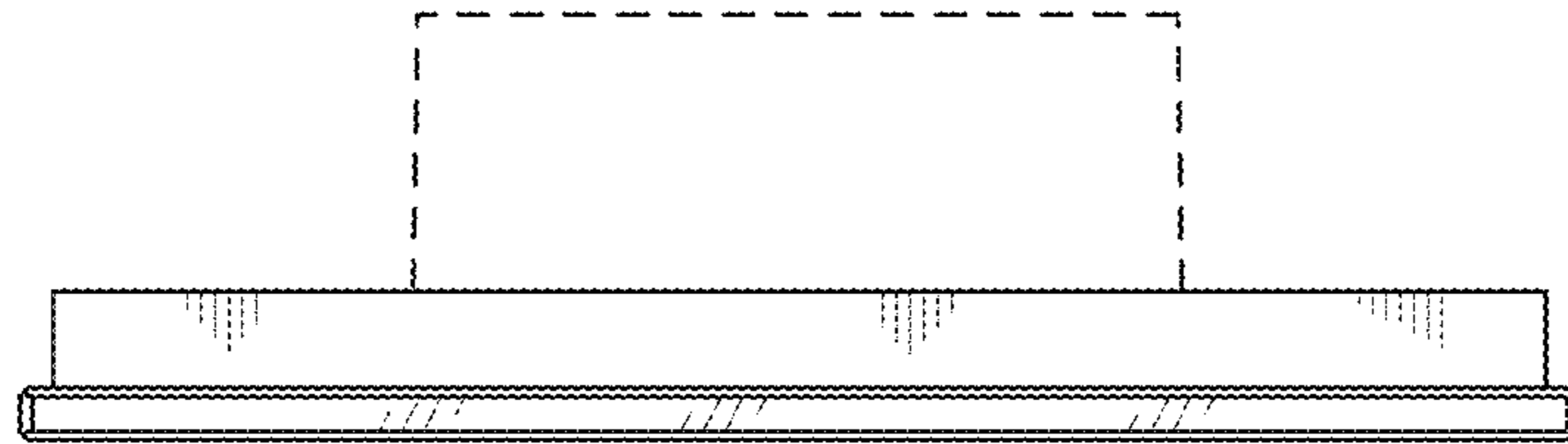

Fig. 13

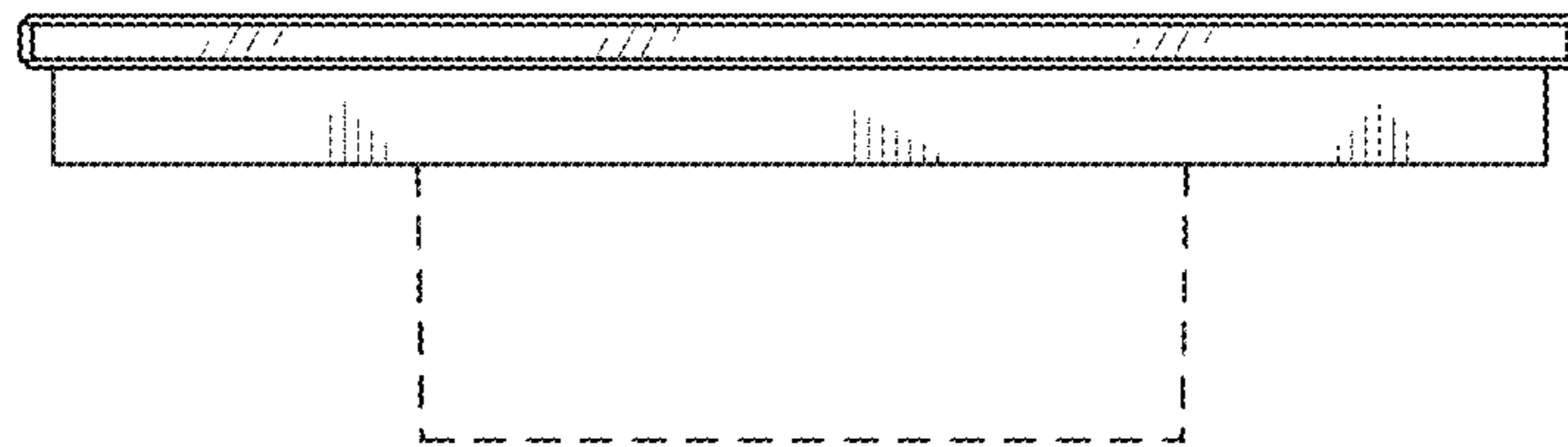

Fig. 14

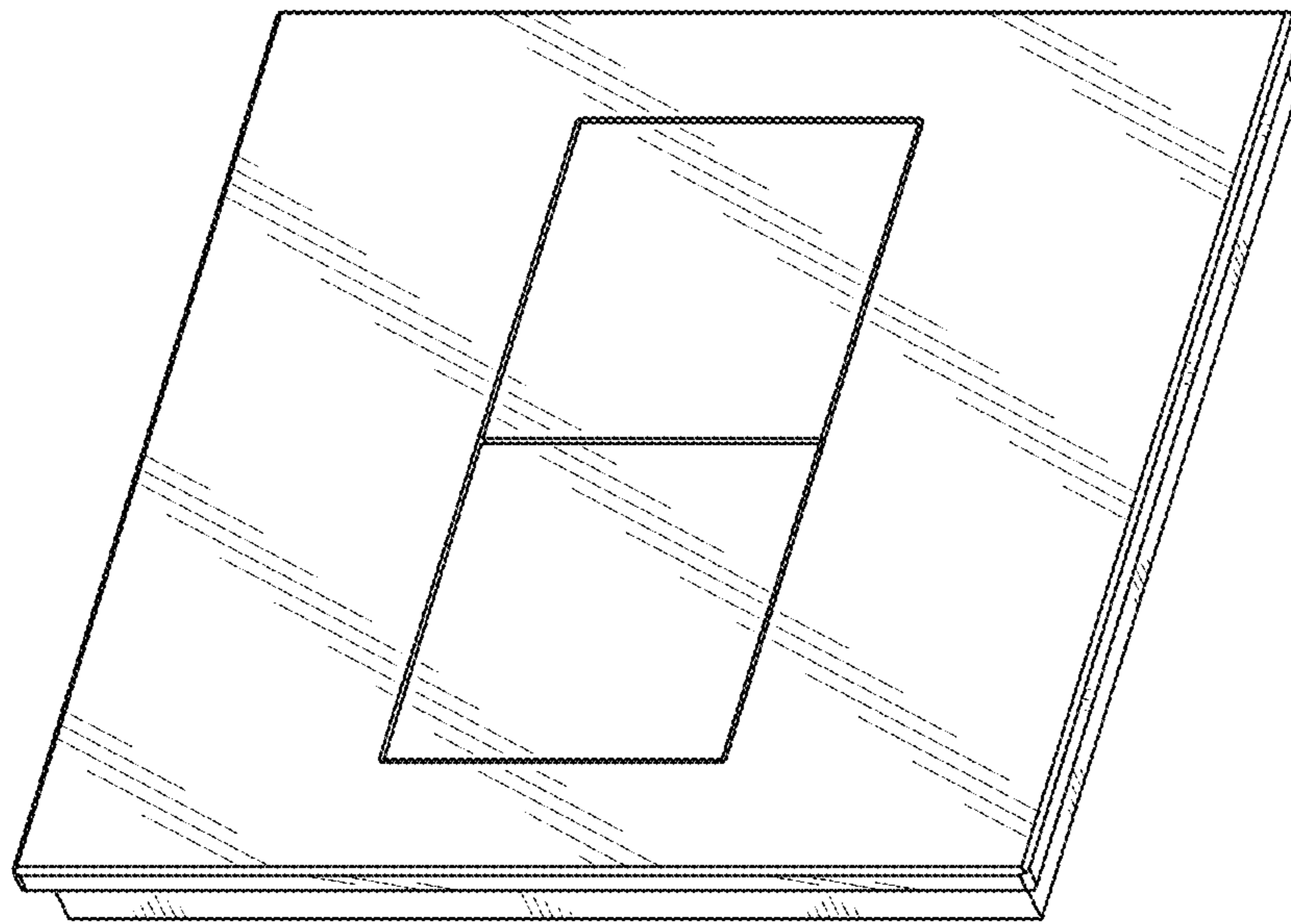

Fig. 15

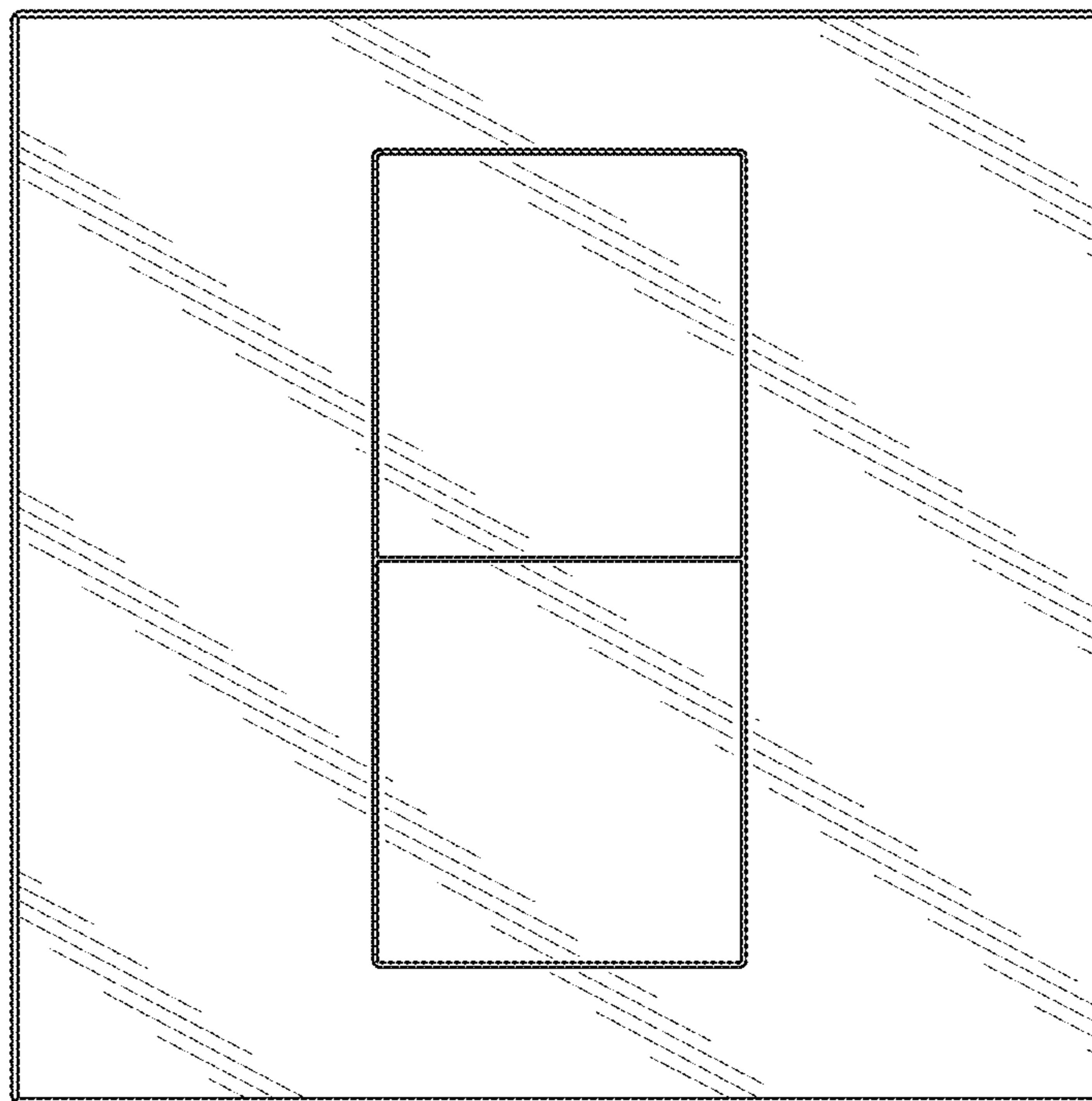

Fig. 16