



US00D803694S

(12) **United States Design Patent**
Essler et al.

(10) **Patent No.:** **US D803,694 S**

(45) **Date of Patent:** **** Nov. 28, 2017**

(54) **BOTTLE**

(71) Applicant: **pheneo GmbH**, Bremen (DE)

(72) Inventors: **Michael Essler**, Cuxhaven (DE); **Sasan Habibi-Naini**, Fischerhude (DE)

(73) Assignee: **PHENEO GMBH**, Bremen (DE)

(**) Term: **14 Years**

(21) Appl. No.: **29/499,353**

(22) Filed: **Aug. 14, 2014**

(30) **Foreign Application Priority Data**

Feb. 17, 2014 (DE) 40 2014 200 553

(51) **LOC (10) Cl.** **09-01**

(52) **U.S. Cl.**
USPC **D9/561**; D9/453

(58) **Field of Classification Search**

USPC D9/516–575, 434–436, 442, 452–454,
D9/682, 693, 694

CPC B65D 1/02; B65D 1/0207; B65D 1/0215;
B65D 1/0223; B65D 1/023; B65D
1/0246; B65D 1/0253; B65D 1/0261;
B65D 1/0276; B65D 1/08; B65D 1/09;
B65D 1/10; B65D 1/40; B65D 1/42;
B65D 1/44; B65D 41/00;

(Continued)

(56) **References Cited**

U.S. PATENT DOCUMENTS

D11,864 S * 7/1880 Lahey D9/561
D35,976 S * 7/1902 McCormick D9/630

(Continued)

Primary Examiner — Catherine Tuttle

(74) *Attorney, Agent, or Firm* — Global IP Counselors,
LLP

(57) **CLAIM**

The ornamental design for a bottle, as shown and described.

DESCRIPTION

FIG. 1 is a right side view showing a first embodiment of our design;
FIG. 2 is a bottom view thereof;
FIG. 3 is a left view thereof;
FIG. 4 is a front view thereof;
FIG. 5 is a perspective view thereof;
FIG. 6 is a back side view thereof;
FIG. 7 is a top view thereof;
FIG. 8 is a right side view showing the embodiment in FIGS. 1-7 with the cap removed to disclose the underlying parts;
FIG. 9 is a bottom view thereof;
FIG. 10 is a left side view thereof;
FIG. 11 is a front view thereof;
FIG. 12 is a perspective view thereof;
FIG. 13 is a back view thereof;
FIG. 14 is a top view thereof;
FIG. 15 is another perspective view thereof;
FIG. 16 is a right side view showing a second embodiment of our new design;
FIG. 17 is a bottom view thereof;
FIG. 18 is a left side view thereof;
FIG. 19 is a front view thereof;
FIG. 20 is a perspective view thereof;
FIG. 21 is a back view thereof;
FIG. 22 is a top view thereof;
FIG. 23 is a right side view showing the embodiment in FIGS. 16-22 with the cap removed to disclose the underlying parts;
FIG. 24 is a bottom view thereof;
FIG. 25 is a left side view thereof;
FIG. 26 is a front view thereof;
FIG. 27 is a perspective view thereof;
FIG. 28 is a back view thereof;
FIG. 29 is a top view thereof; and,
FIG. 30 is another perspective view thereof.

1 Claim, 30 Drawing Sheets

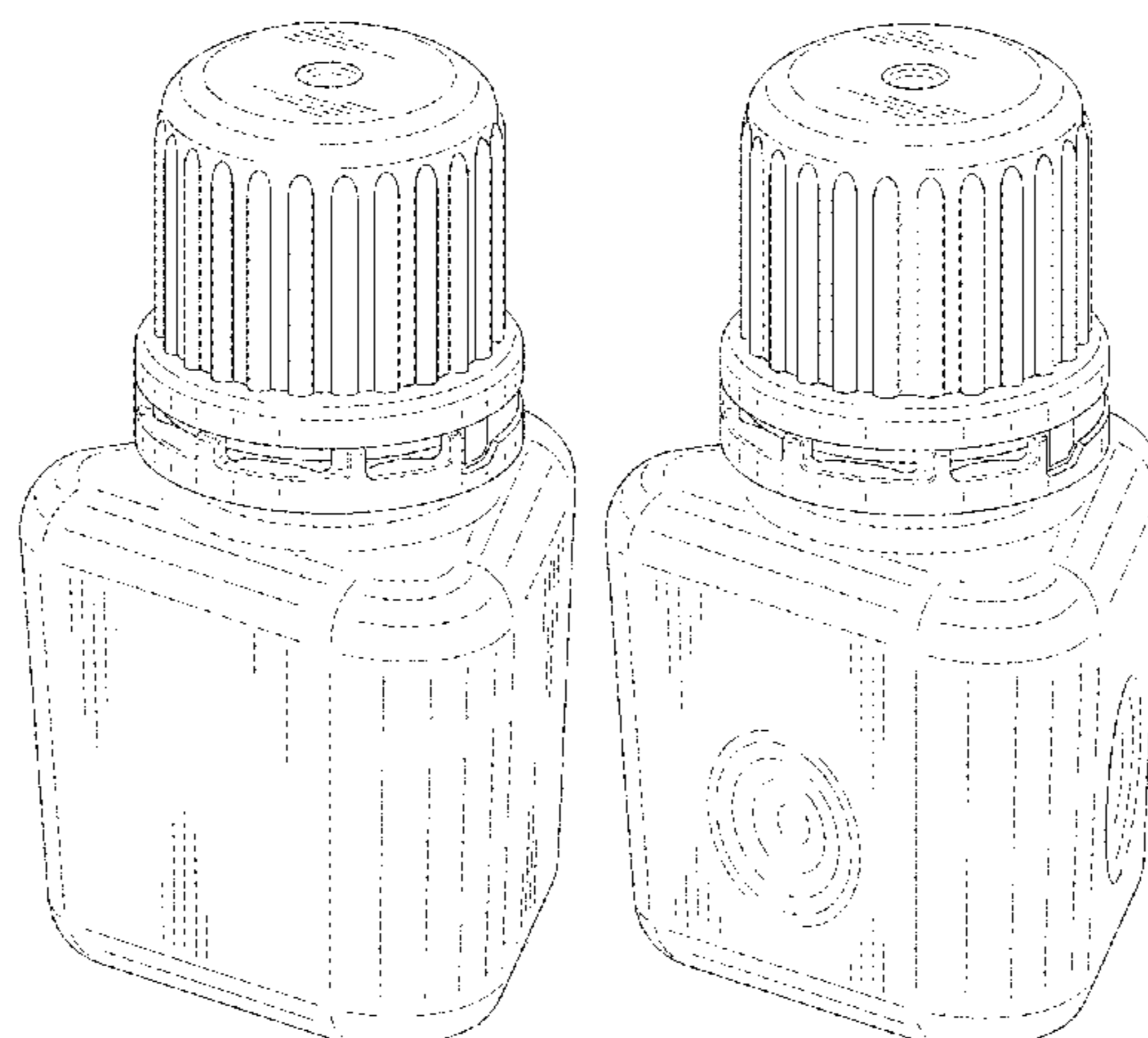

(58) **Field of Classification Search**

CPC B65D 41/04; B65D 41/0428; B65D 41/0471; B65D 41/06; B65D 41/0485; B65D 41/08; B65D 50/00; B65D 50/02; B65D 50/04; B65D 50/041; B65D 50/043; B65D 50/045; B65D 50/046; B65D 50/048; B65D 50/06; B65D 50/061; B65D 50/062; B65D 50/063; B65D 50/064; B65D 50/065; B65D 50/066; B65D 50/067; B65D 50/068; B65D 50/069; B65D 2215/00; B65D 2215/02; B65D 2251/023; B65D 2501/00; B65D 2501/0027; B65D 2501/0045; B65D 2501/0081; B65D 2585/56; B65D 41/34; B65D 41/3409; B65D 41/3447
See application file for complete search history.

D304,294	S *	10/1989	Grenda	D7/700
D311,681	S *	10/1990	Aggarwal	D9/547
D325,167	S *	4/1992	Humfress	D9/453
D476,902	S *	7/2003	Snyder	D9/561
D542,133	S *	5/2007	Haber	D9/453
D564,355	S *	3/2008	Berman	D9/453
D566,555	S *	4/2008	Berman	D9/453
D578,001	S *	10/2008	Braukmann	D9/453
D594,345	S *	6/2009	Short	D9/561
D598,295	S *	8/2009	Miceli	D9/561
D624,432	S *	9/2010	Fox	D9/561
D627,657	S *	11/2010	Vogler	D9/520
D646,580	S *	10/2011	Dolhun	D9/561
D653,554	S *	2/2012	Kitazawa	D9/561
8,495,854	B2 *	7/2013	Seidita	B65B 7/2835 53/471
D695,620	S *	12/2013	Karekar	D9/529
D740,680	S *	10/2015	Christian	D9/561
2011/0309083	A1 *	12/2011	Hsiu-Tzu Charlene	A45D 34/00 220/505
2014/0166606	A1 *	6/2014	Brozell	B65D 23/06 215/44

(56) **References Cited**

U.S. PATENT DOCUMENTS

D48,866 S * 4/1916 Merrill D9/561
D199,203 S * 9/1964 Dailey D9/561

* cited by examiner

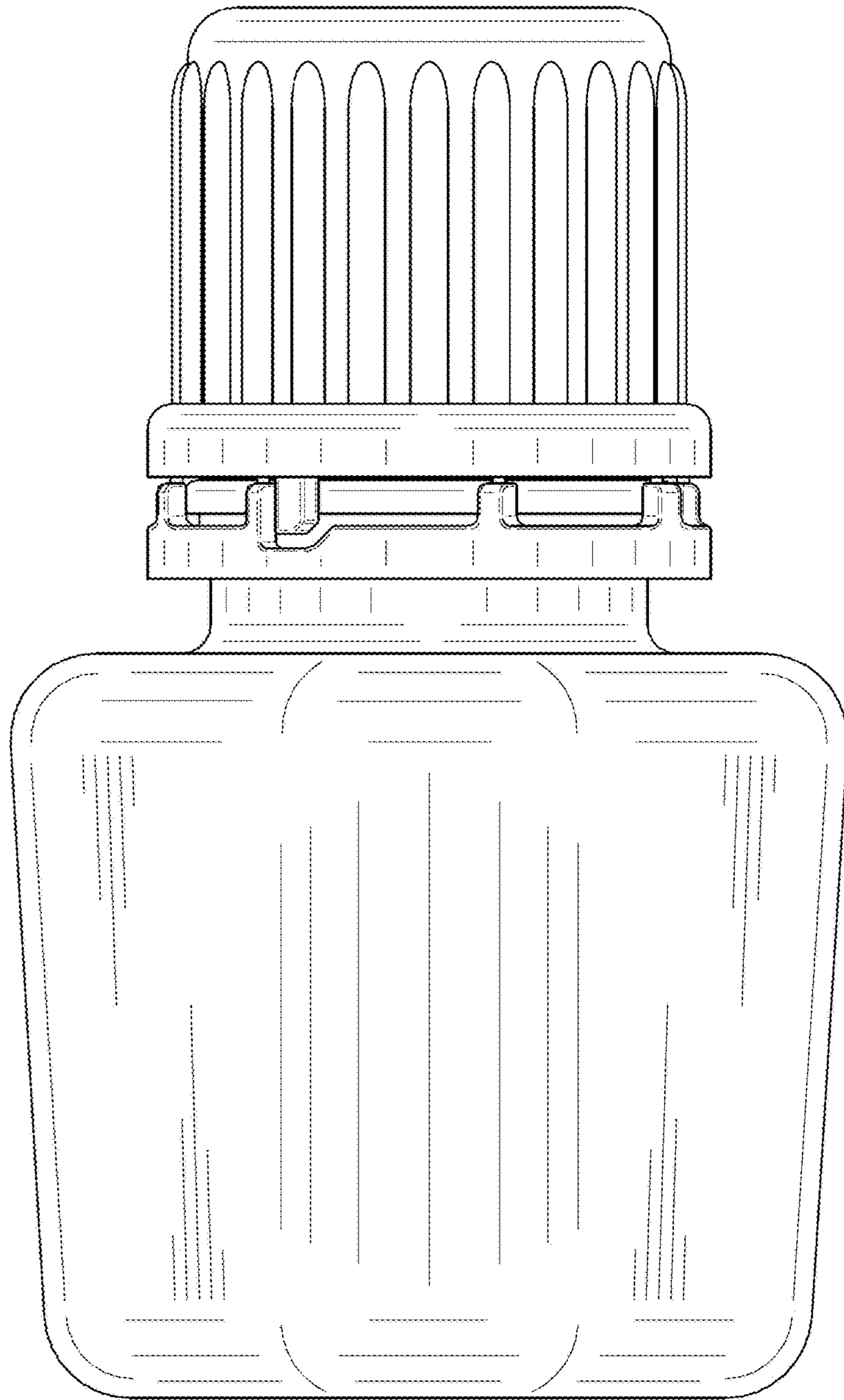

FIG. 1

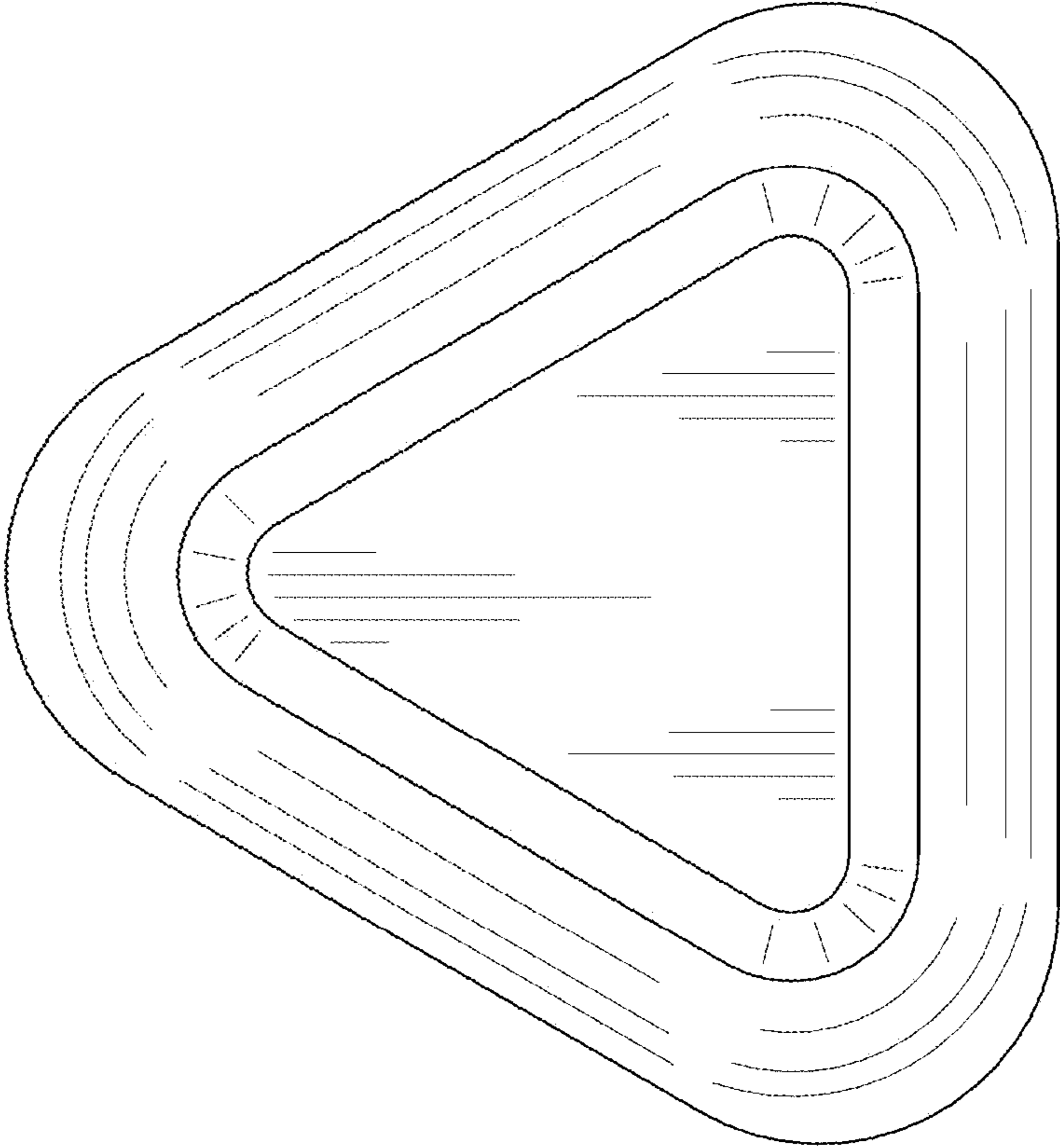

FIG. 2

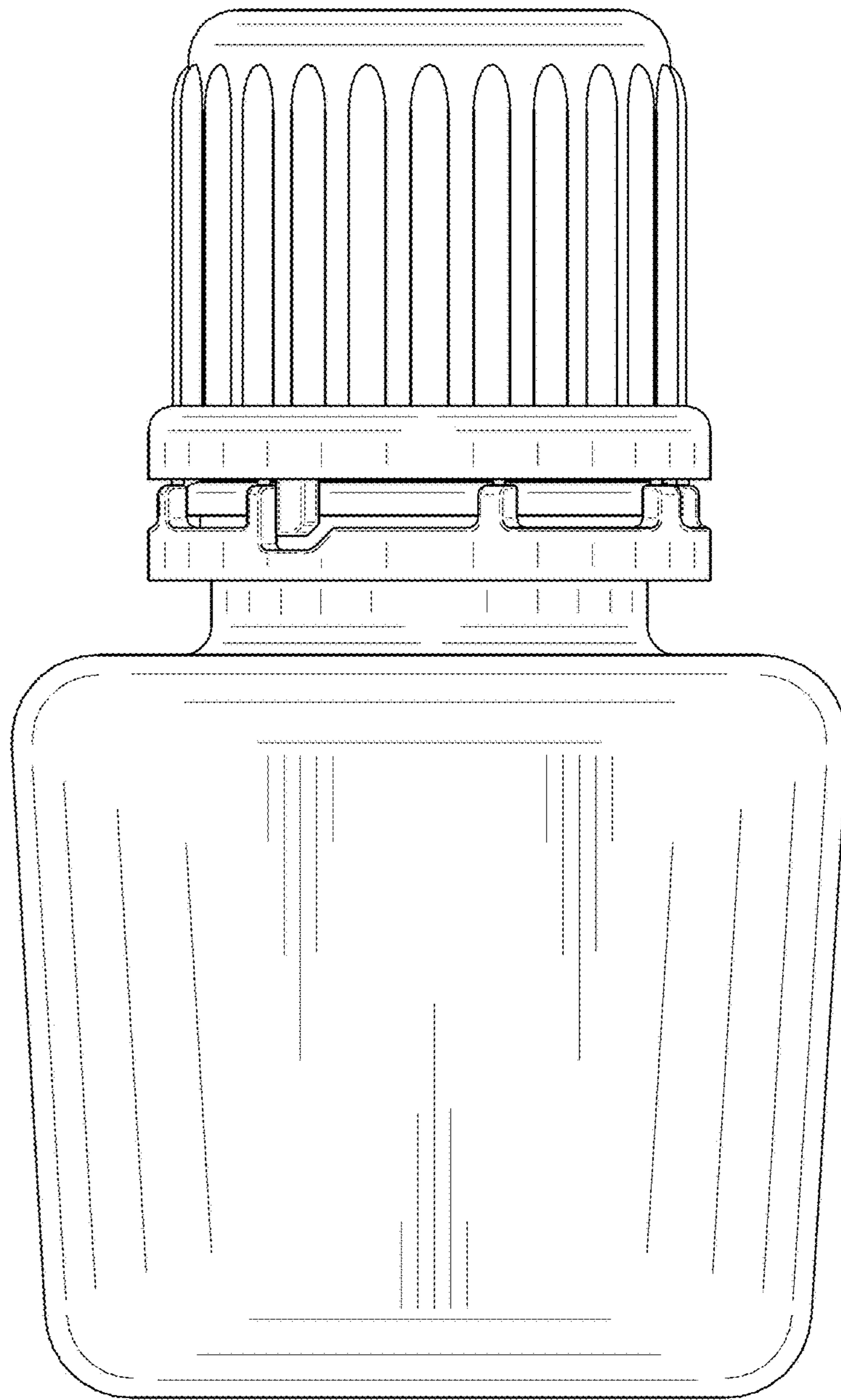

FIG. 3

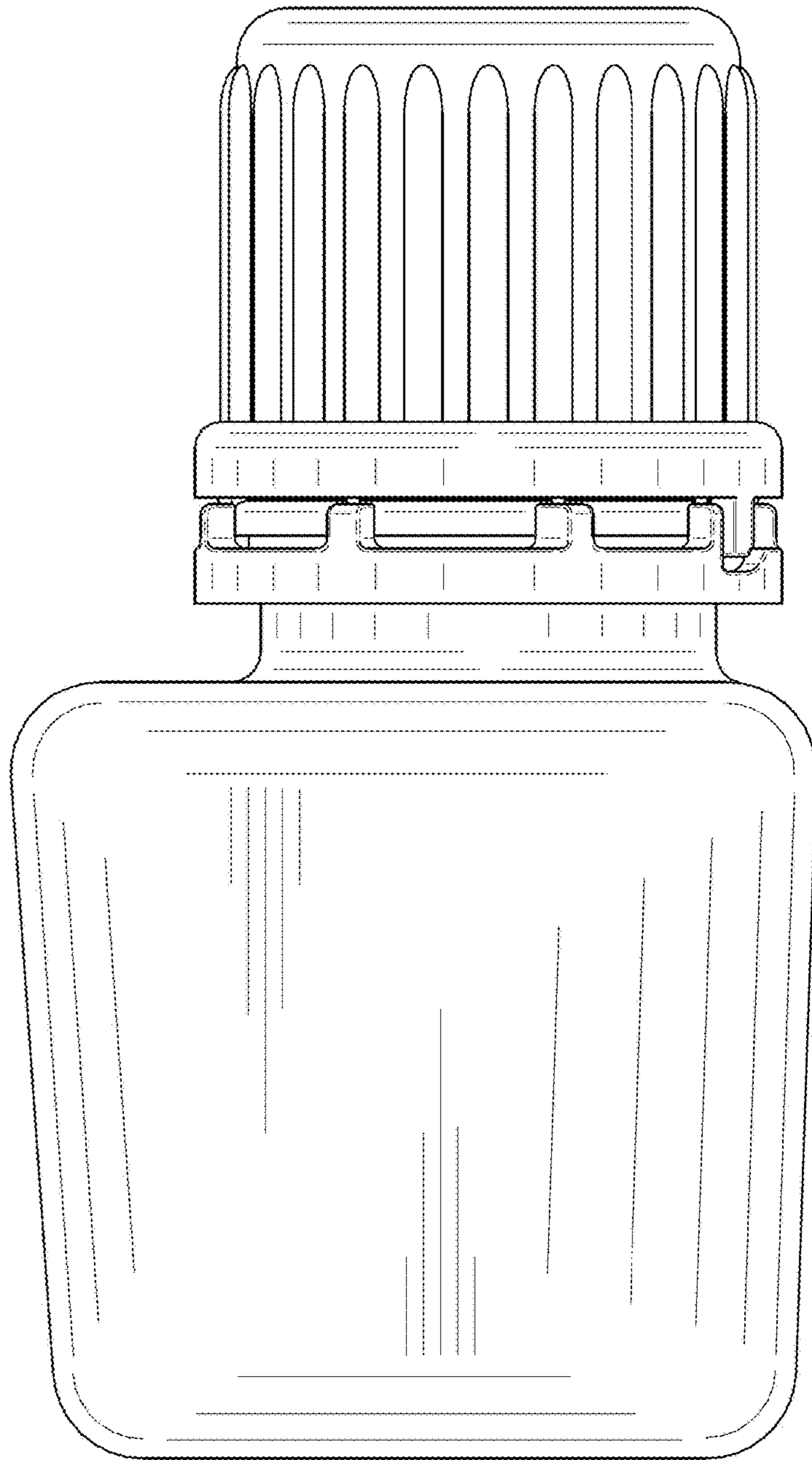

FIG. 4

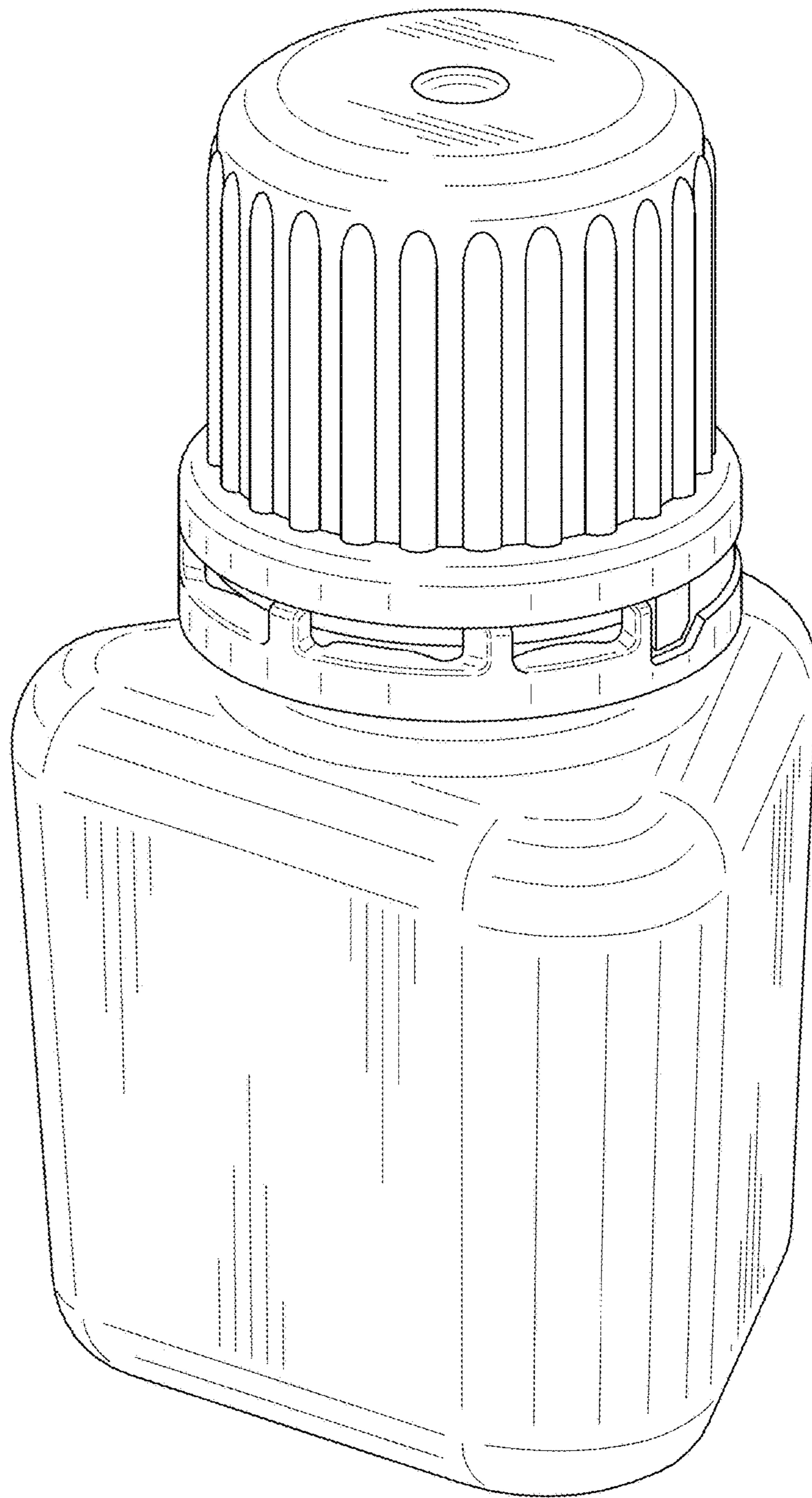

FIG. 5

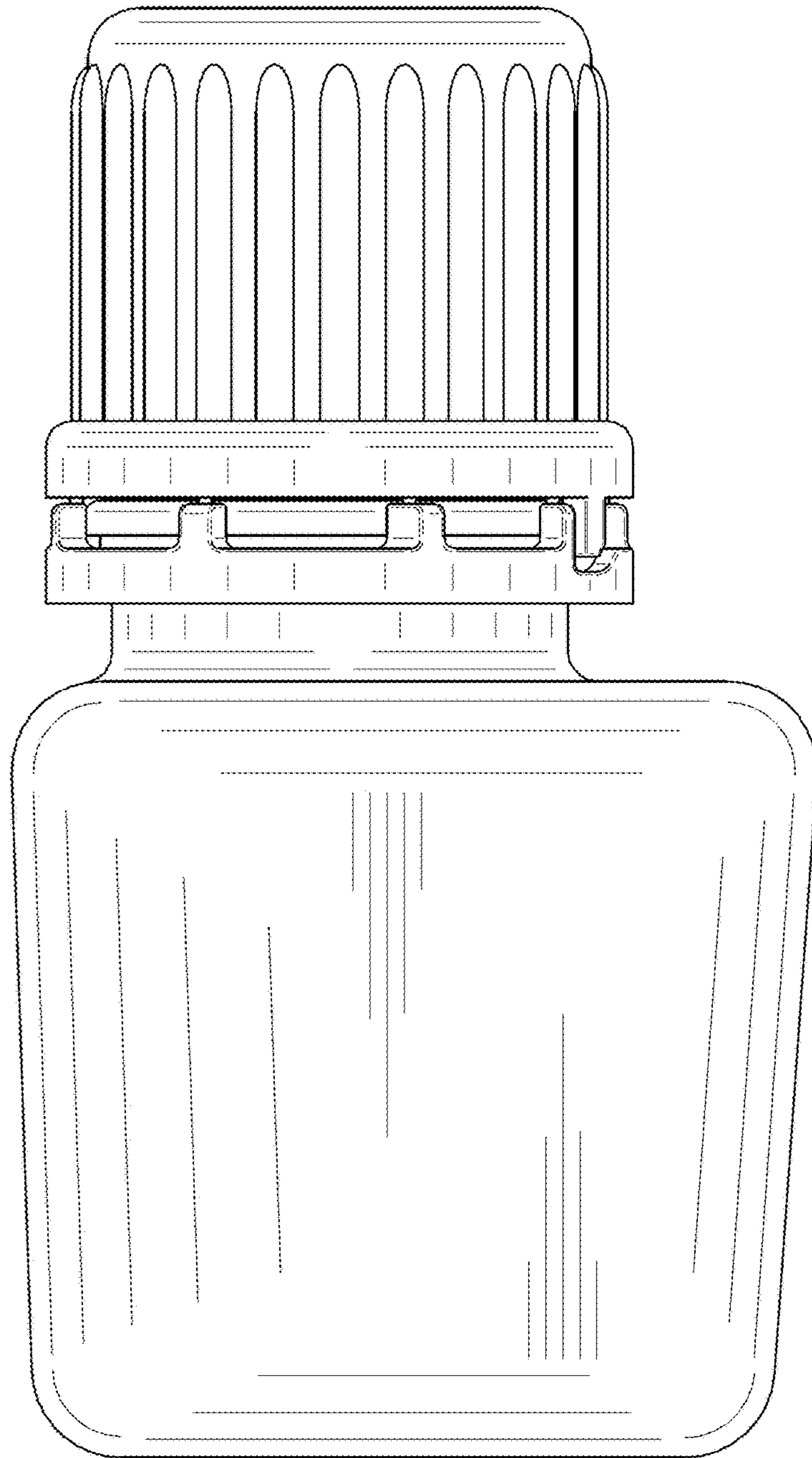

FIG. 6

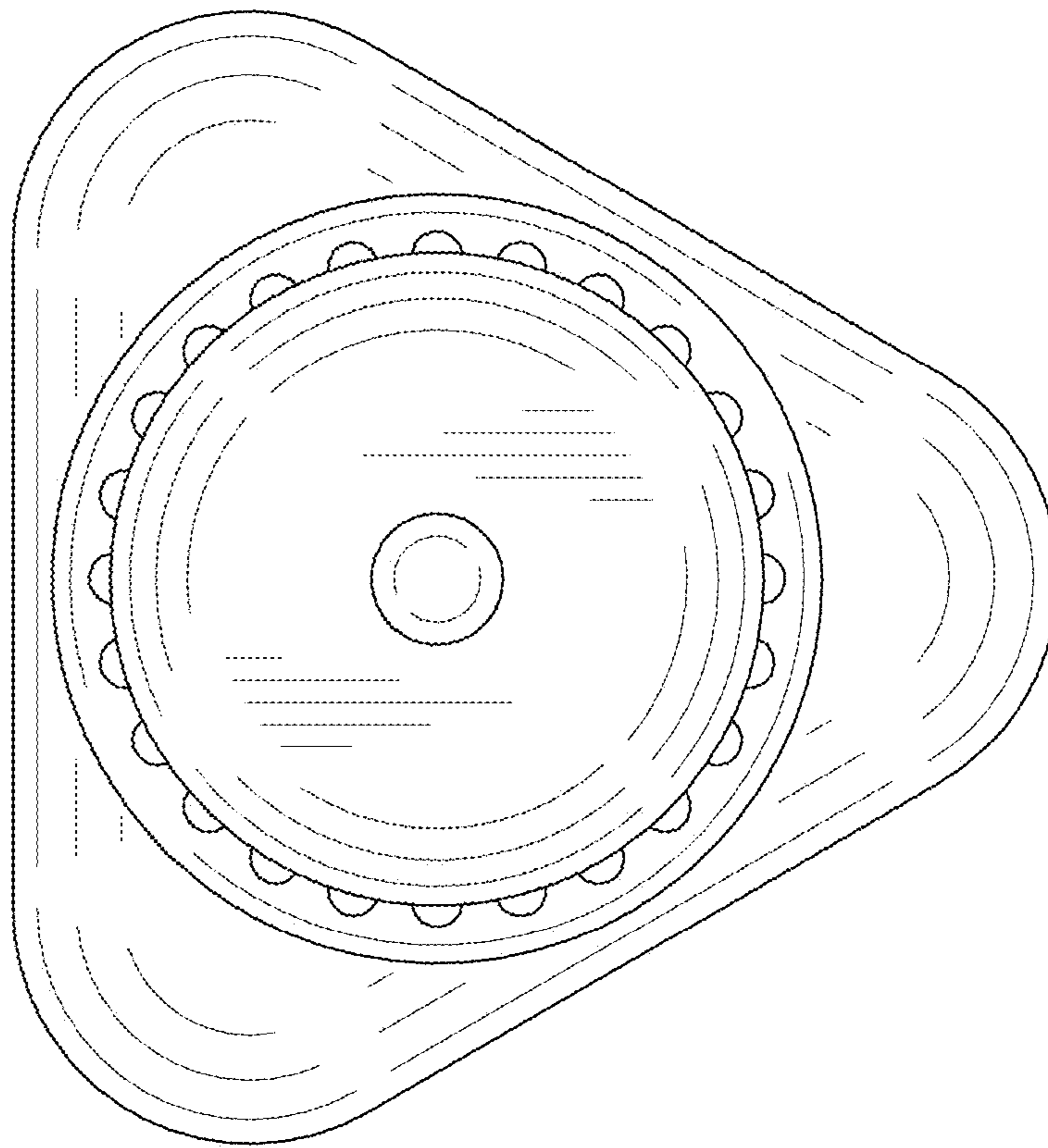

FIG. 7

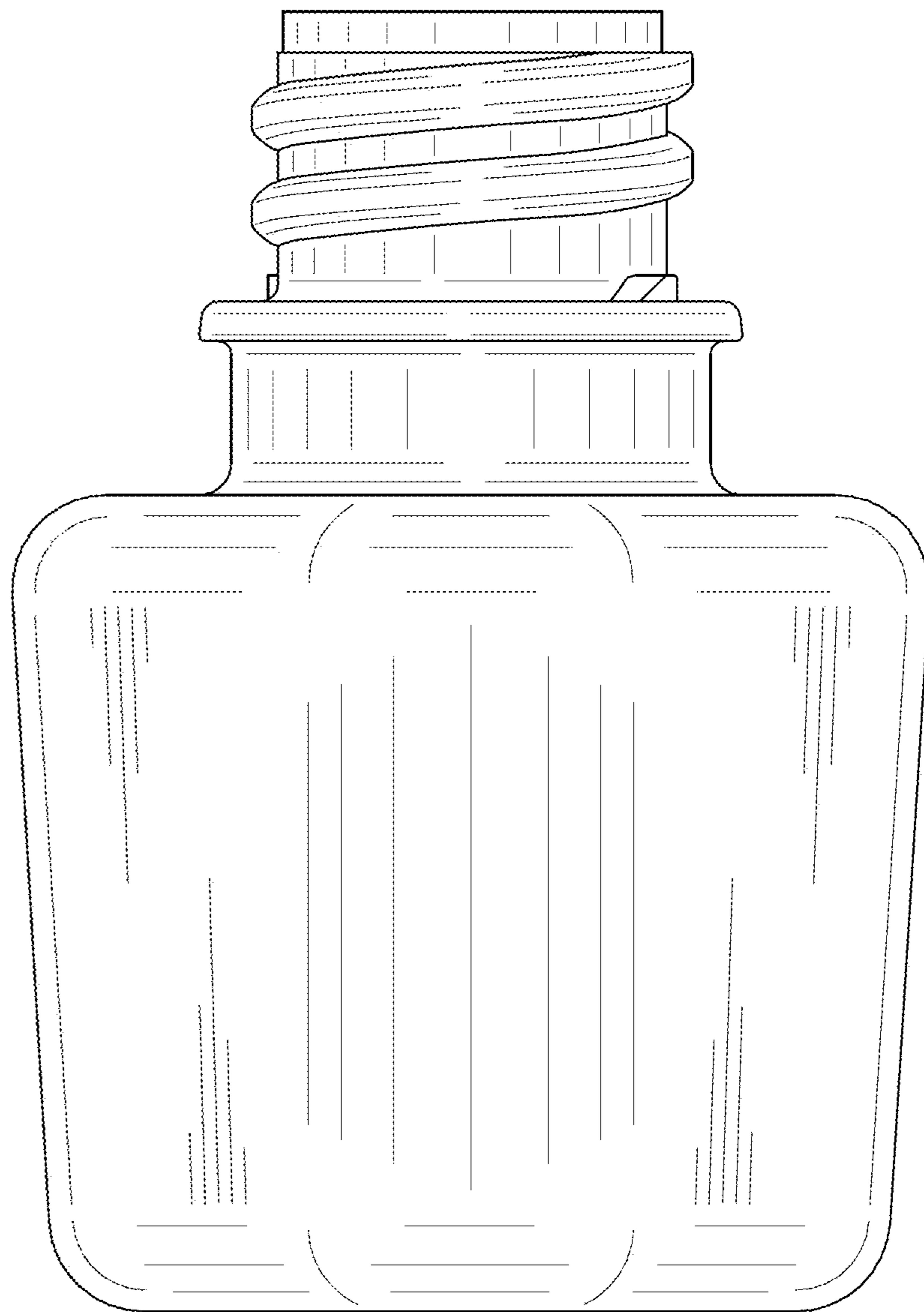

FIG. 8

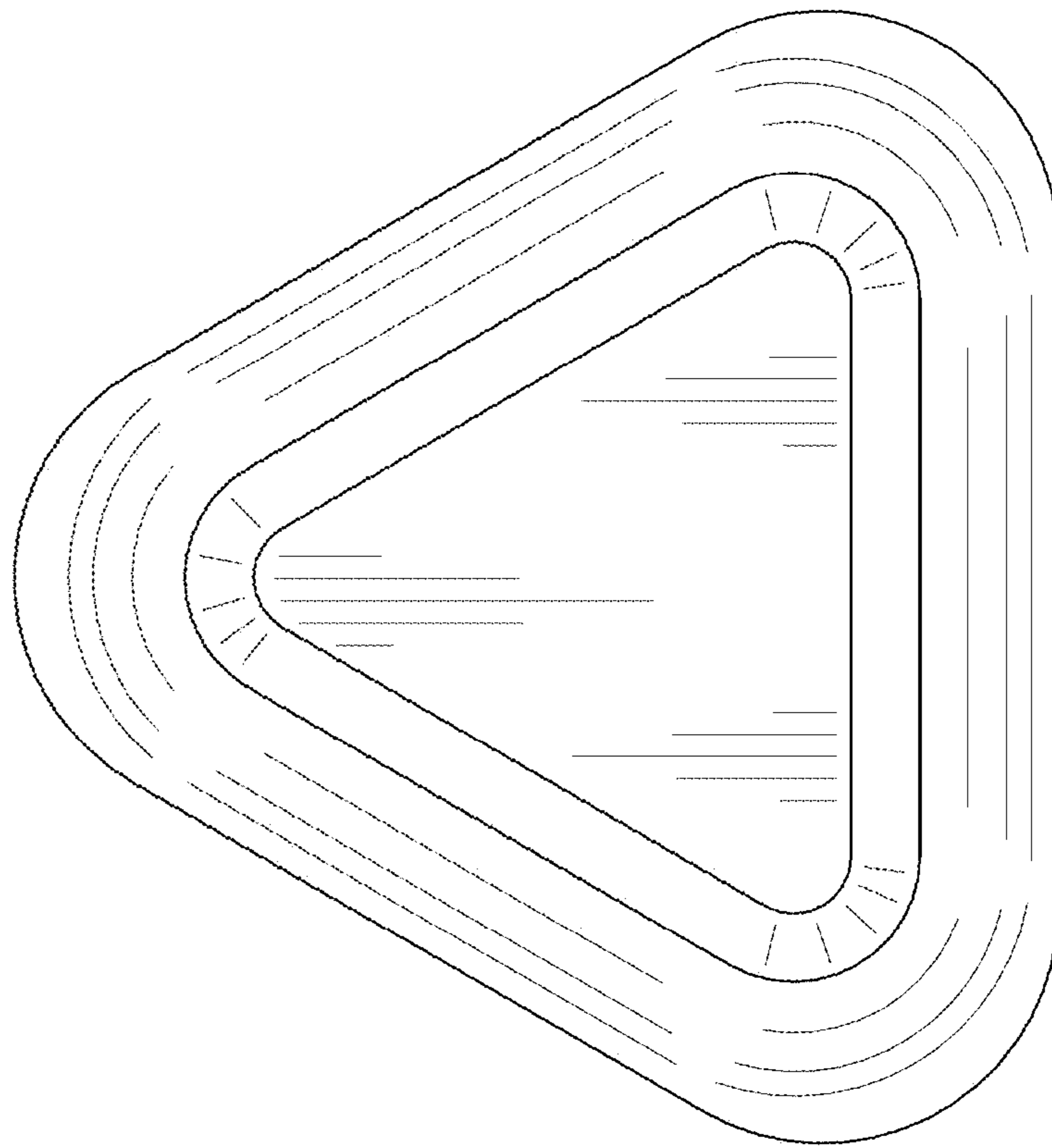

FIG. 9

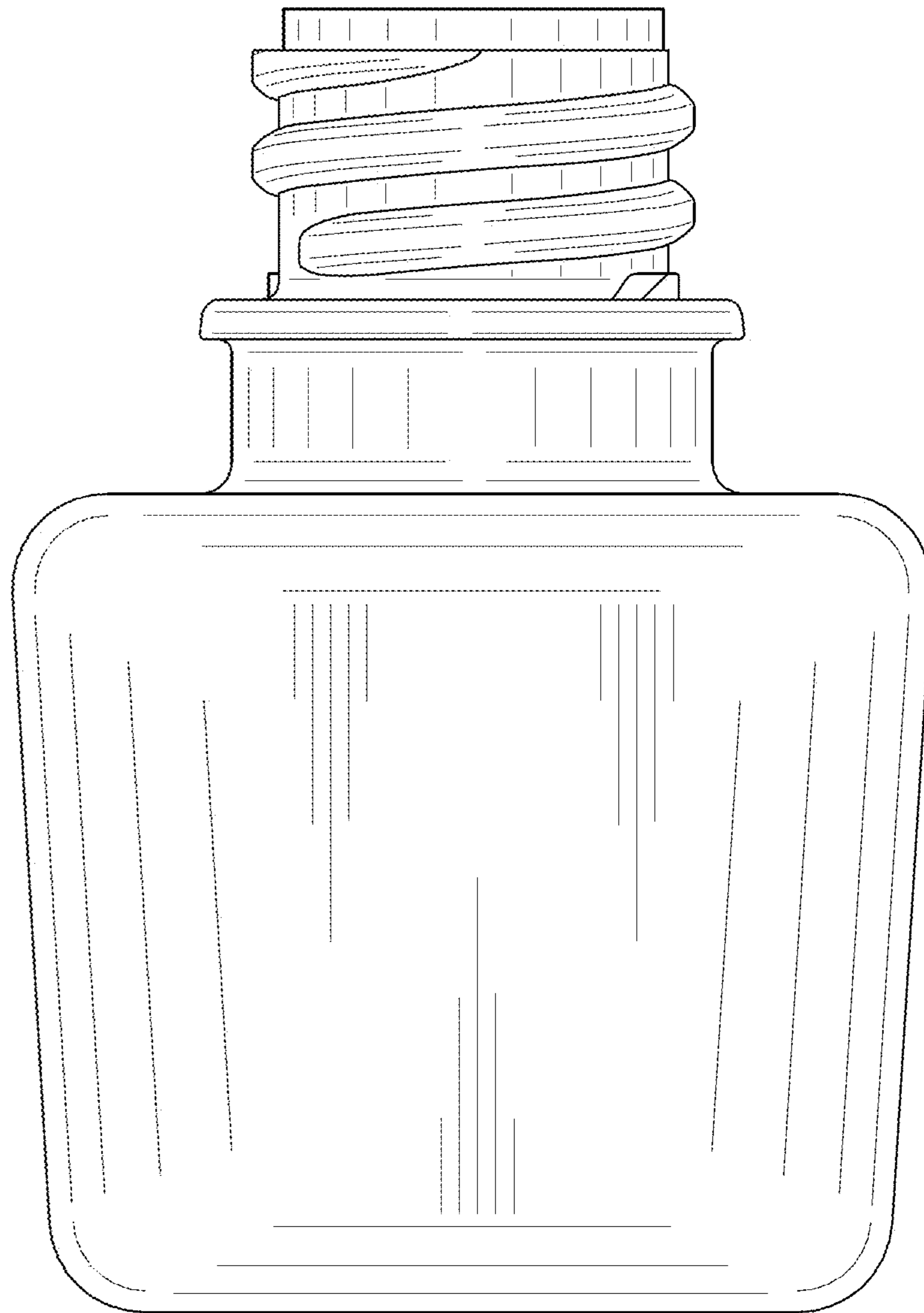

FIG. 10

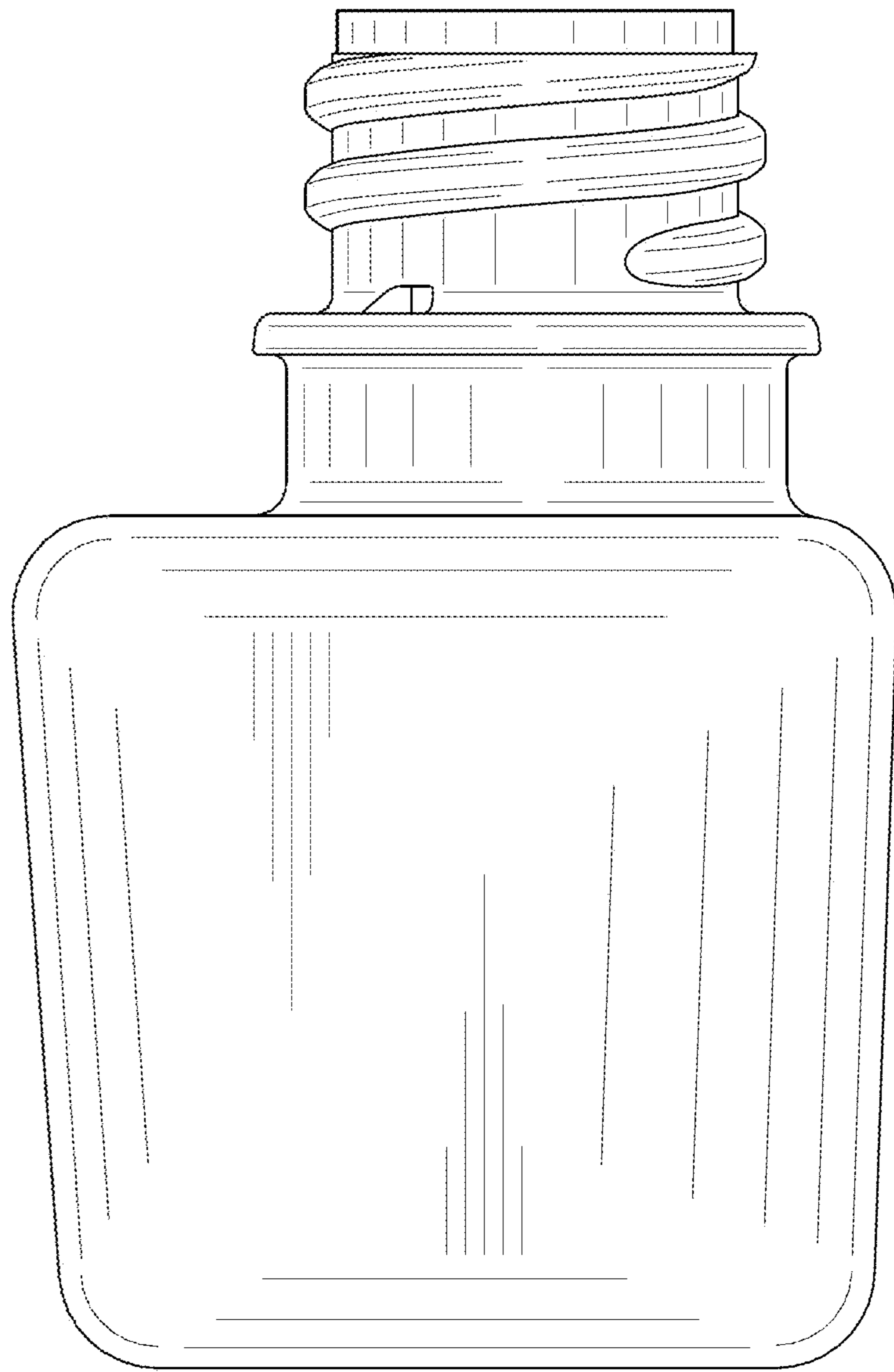

FIG. 11

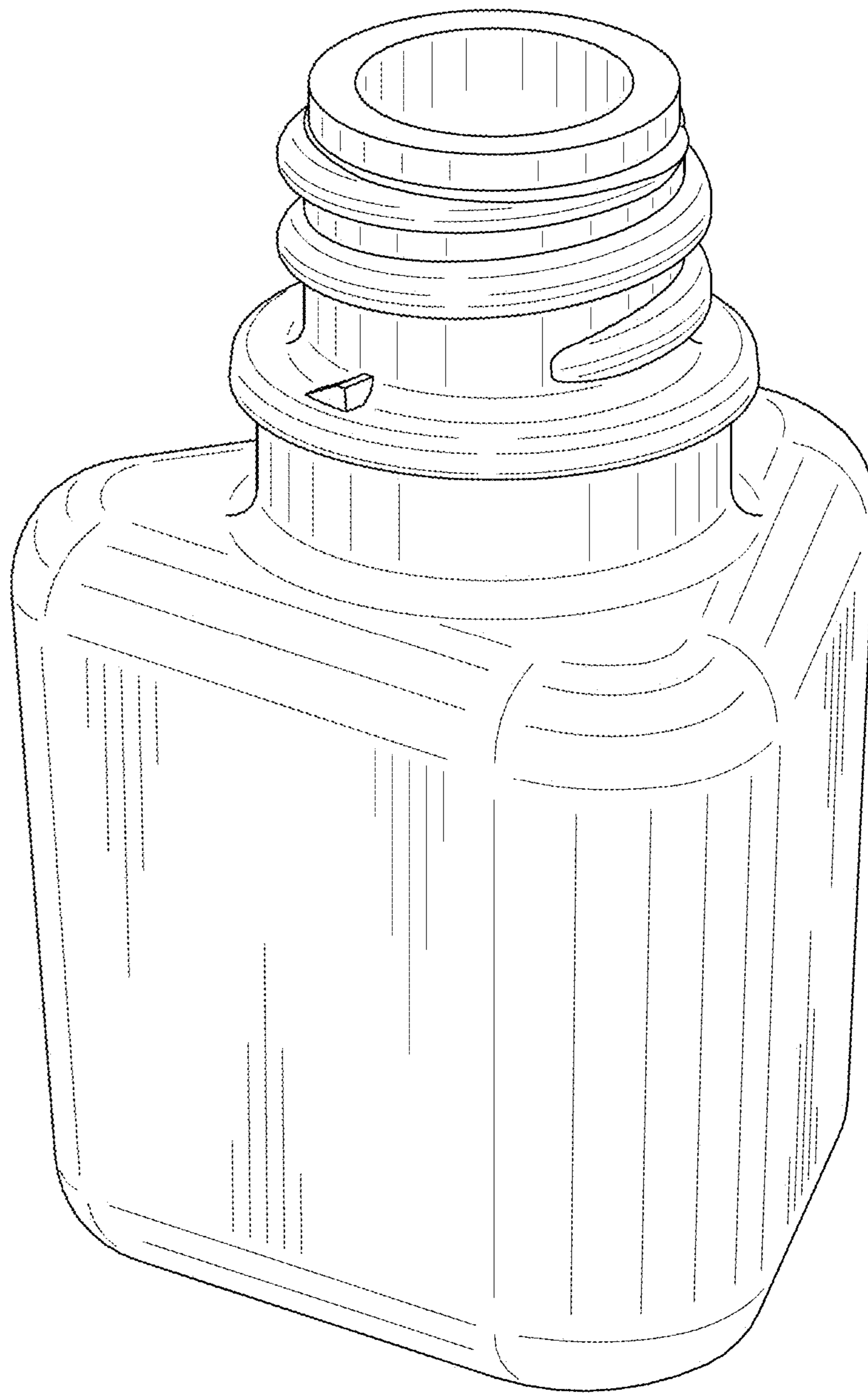

FIG. 12

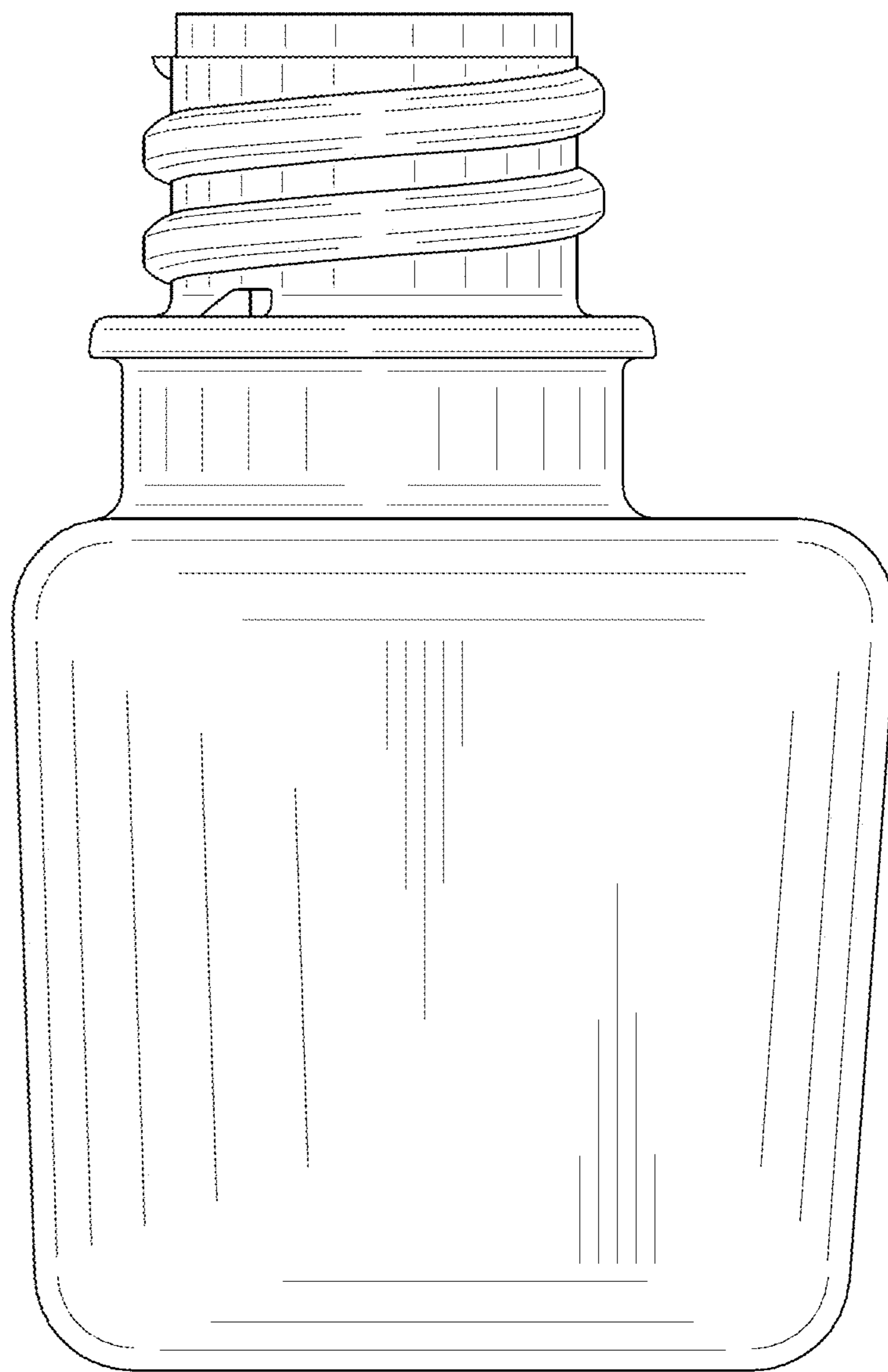

FIG. 13

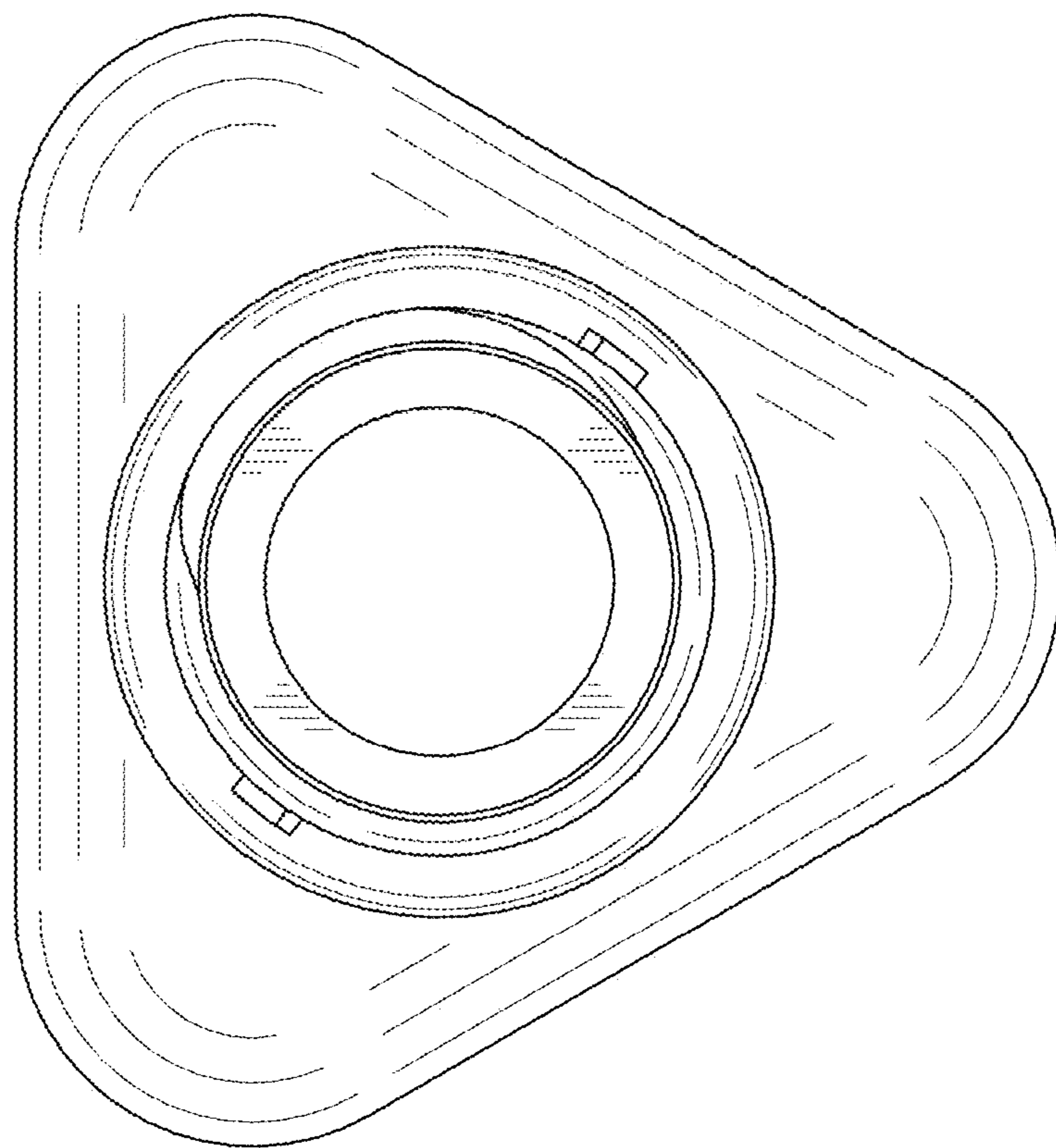

FIG. 14

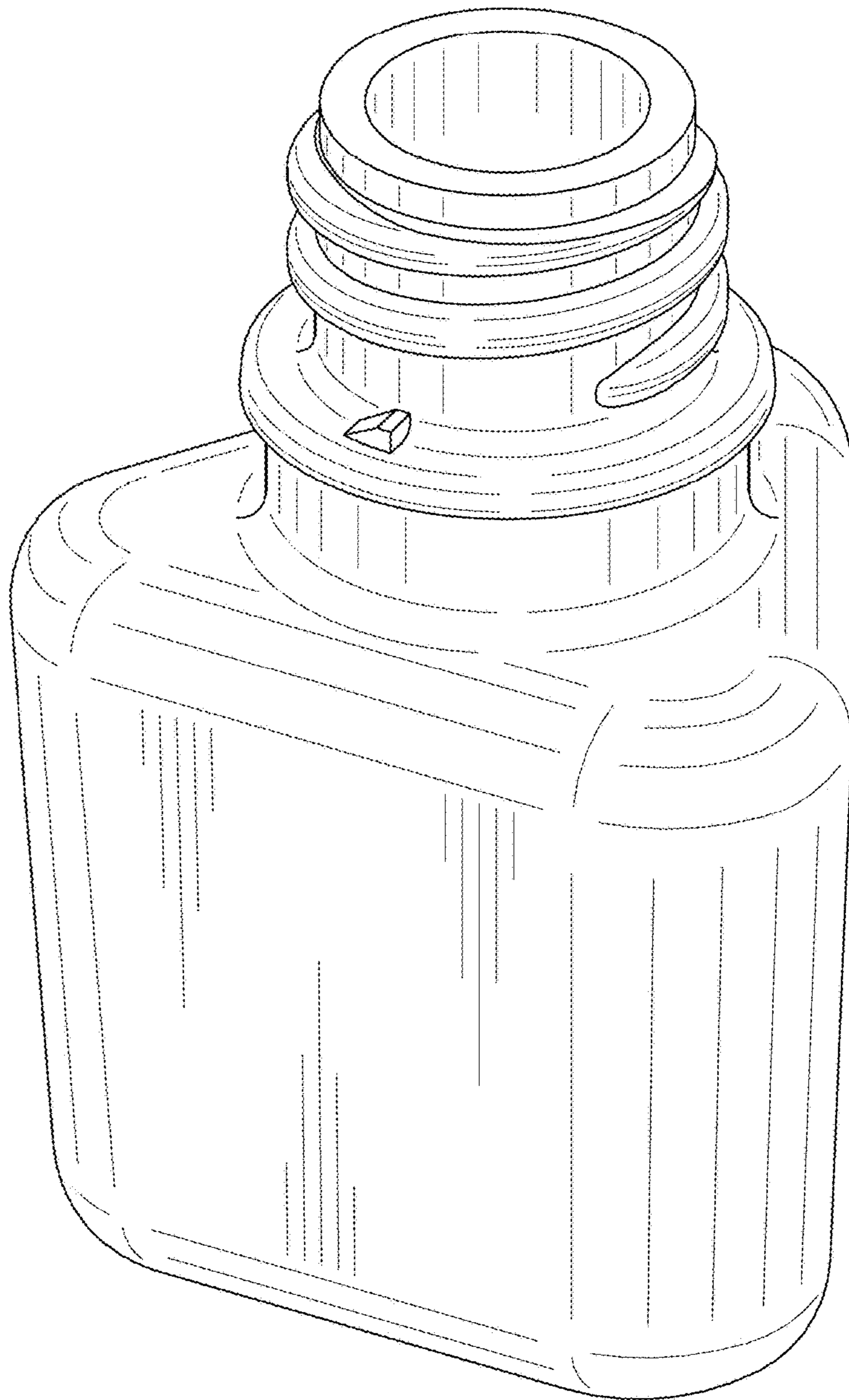

FIG. 15

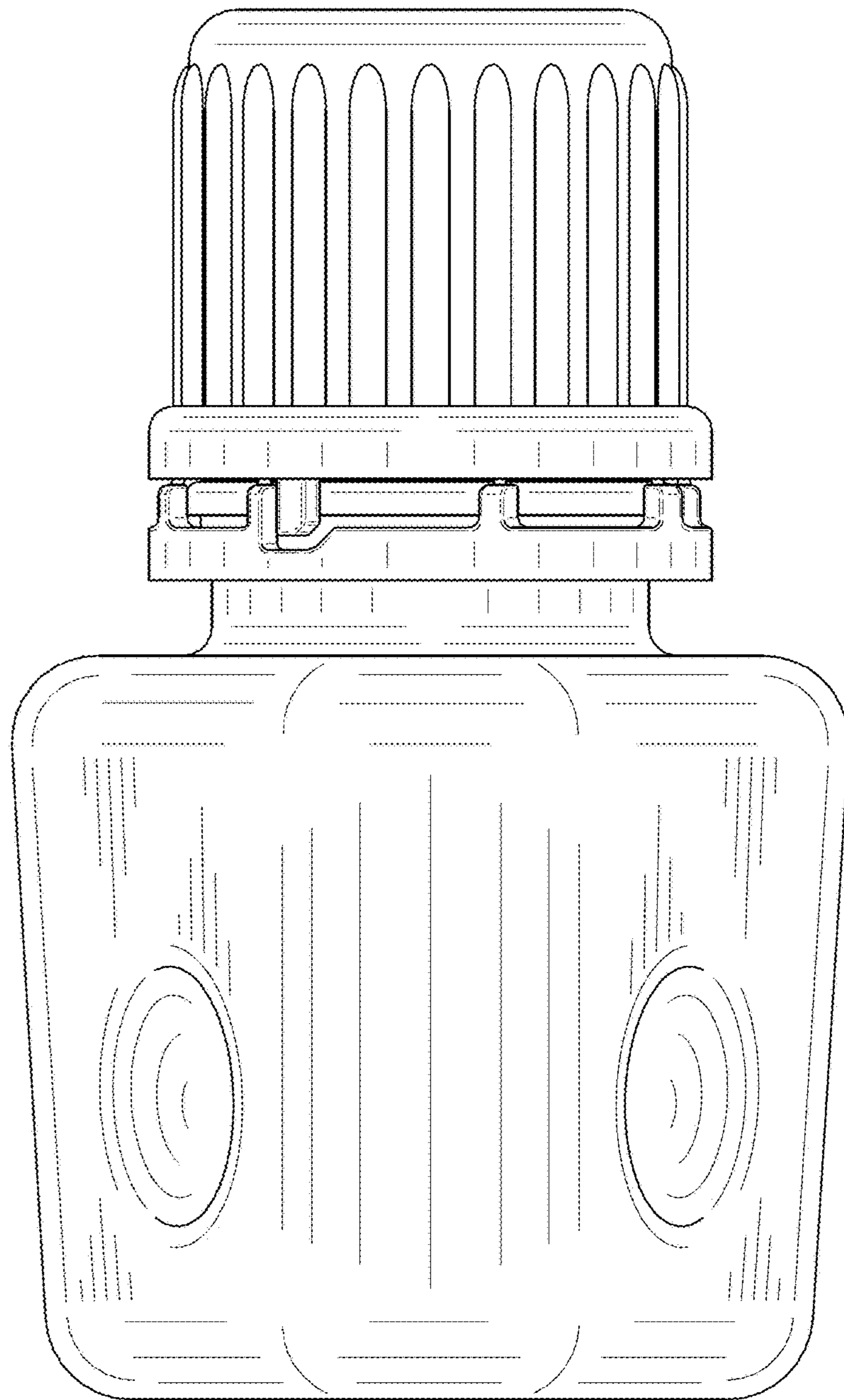

FIG. 16

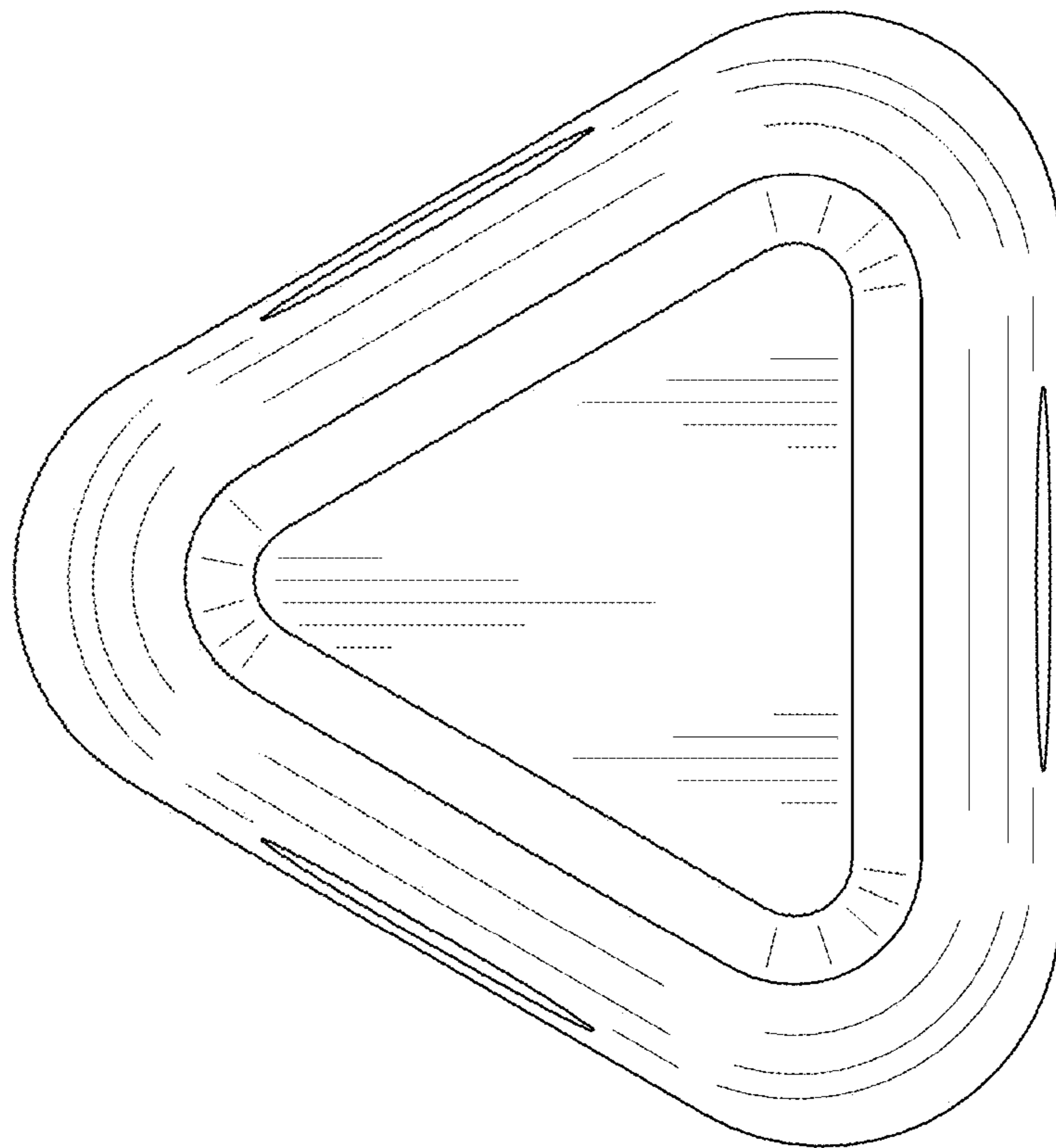

FIG. 17

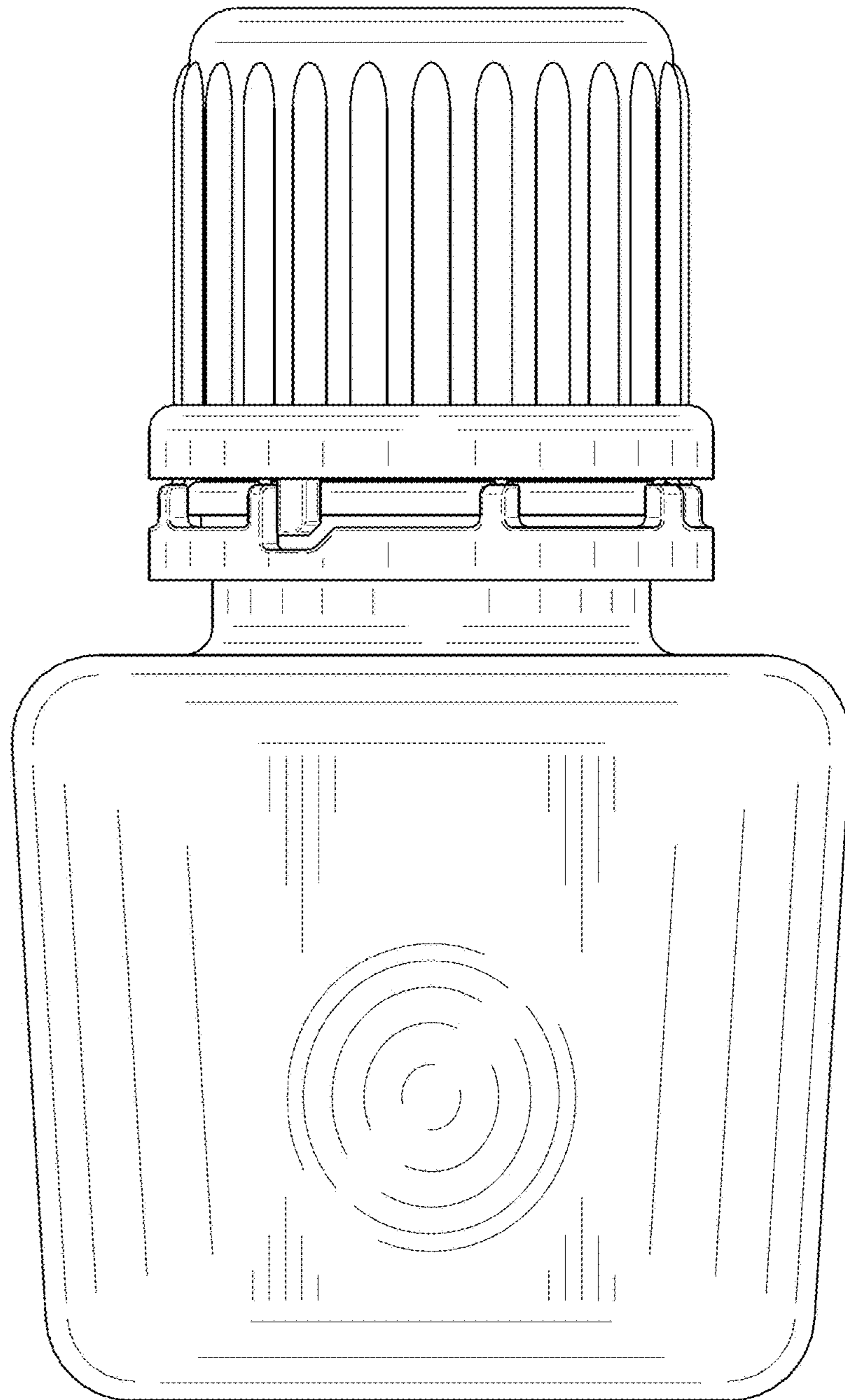

FIG. 18

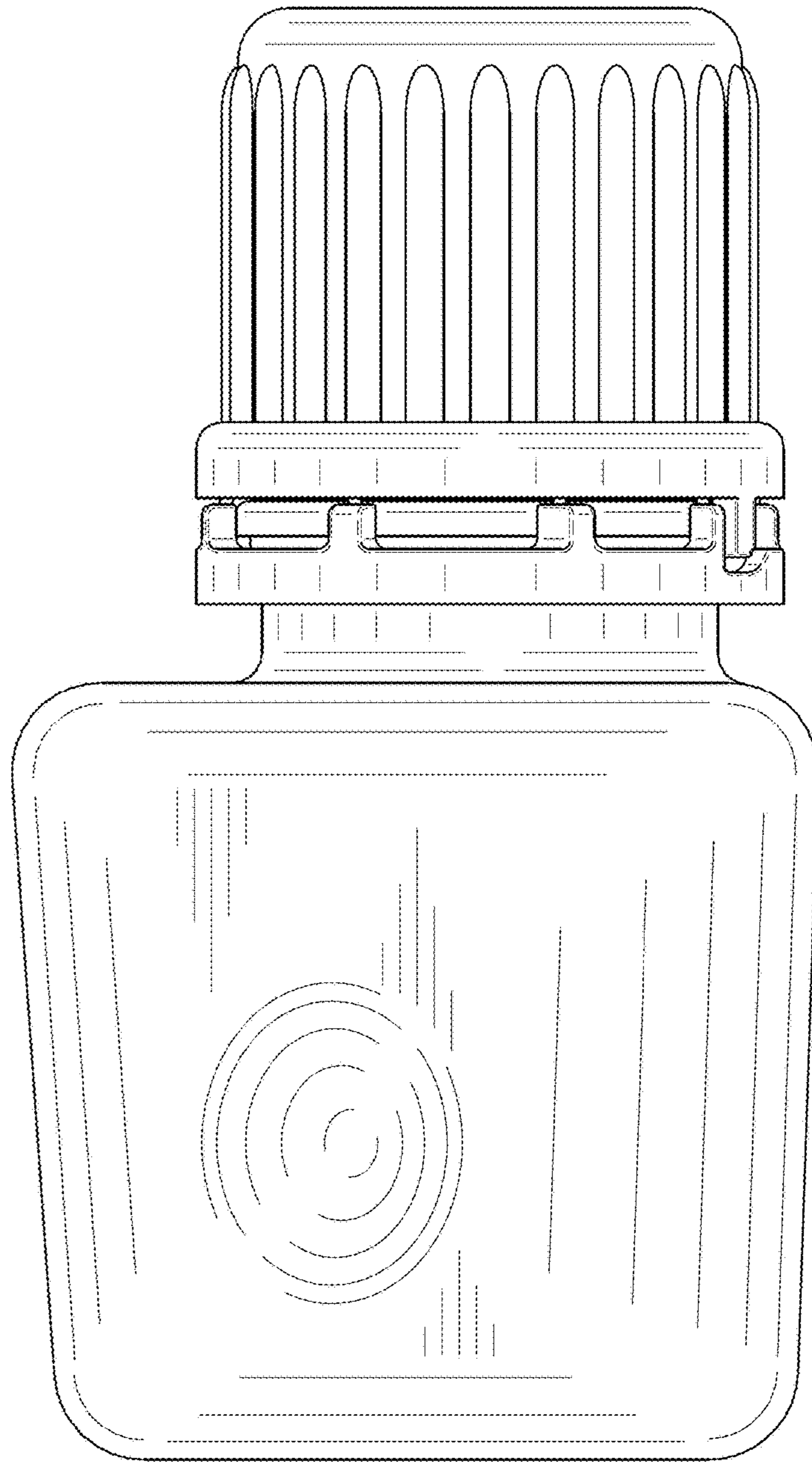

FIG. 19

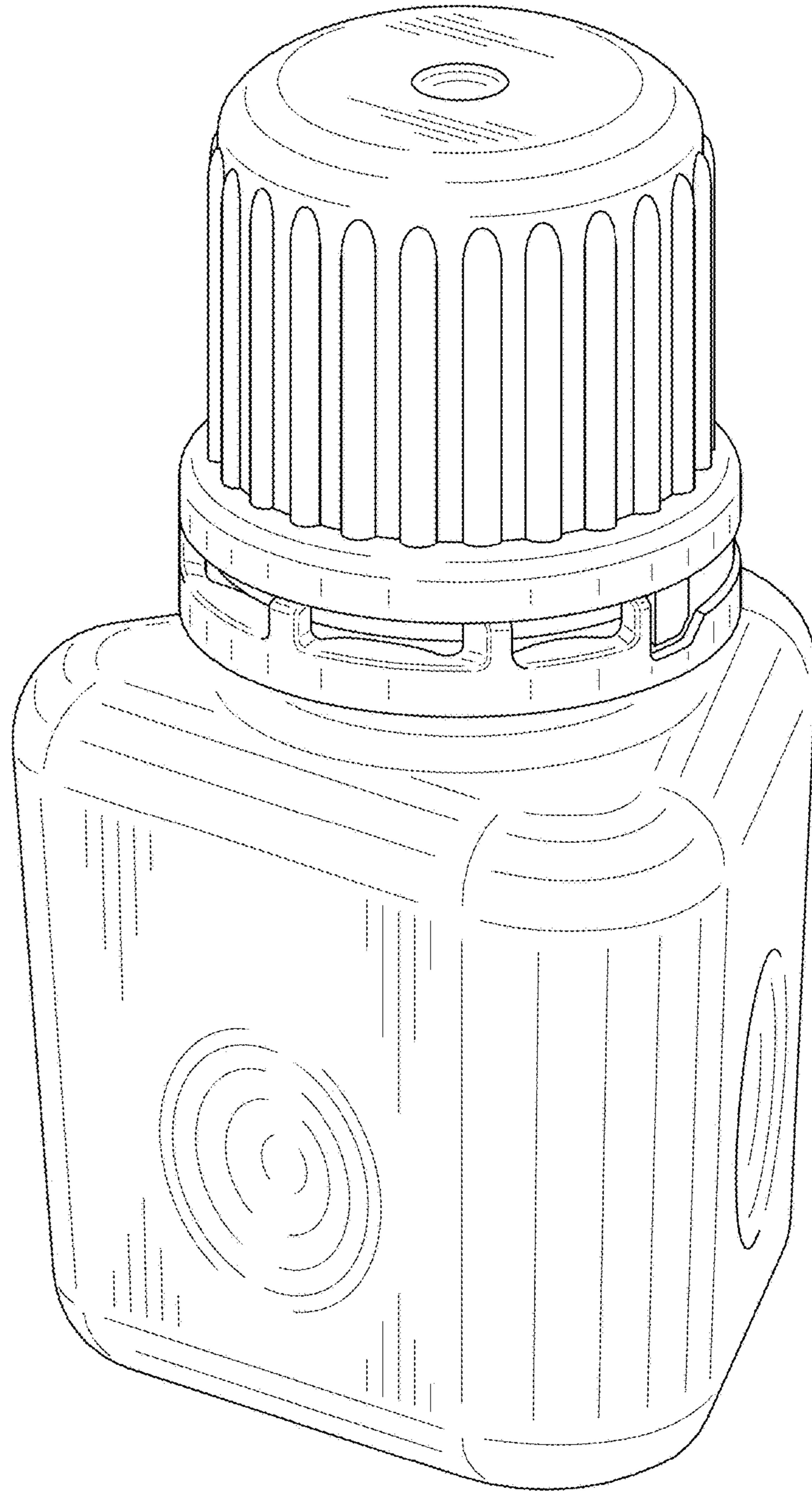

FIG. 20

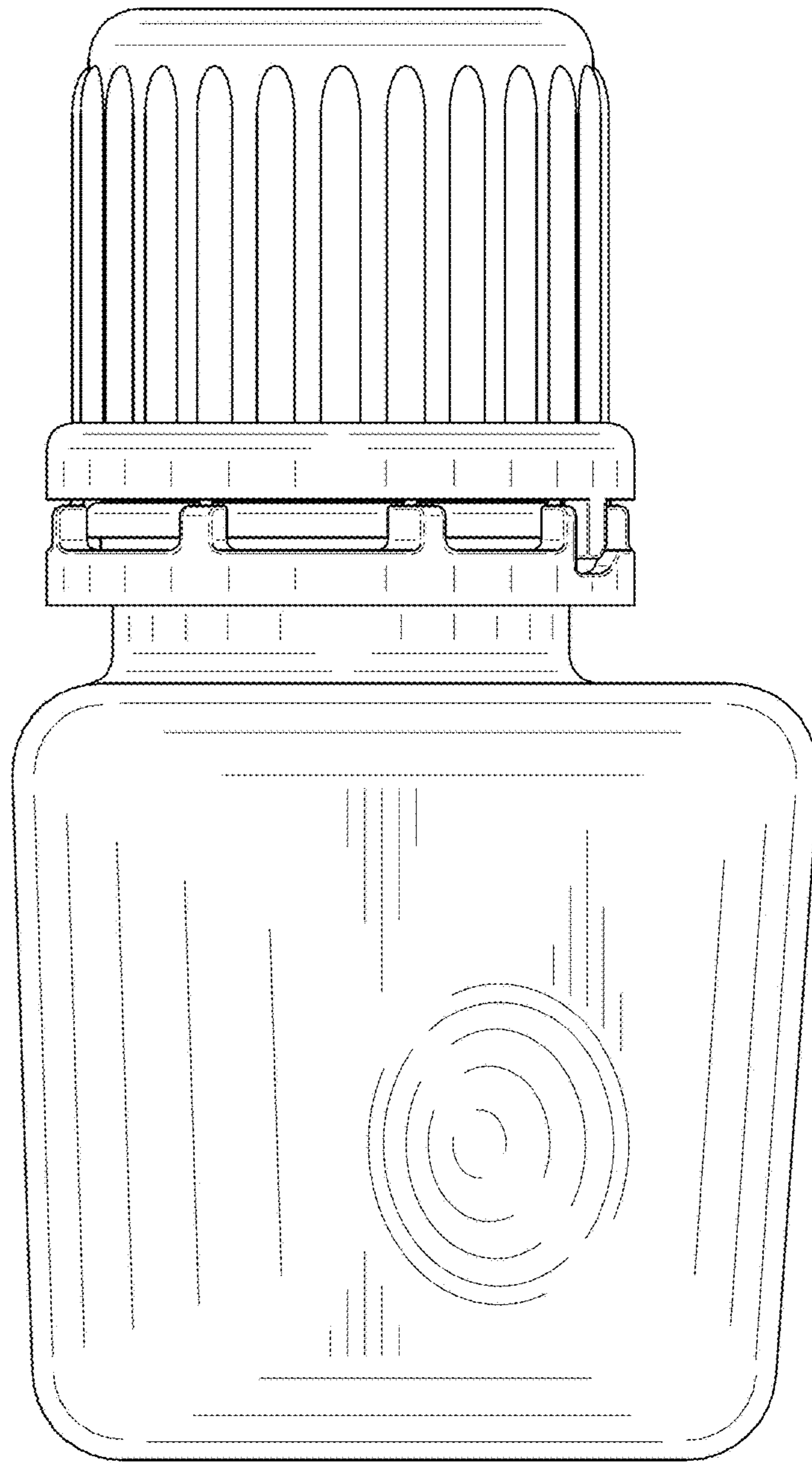

FIG. 21

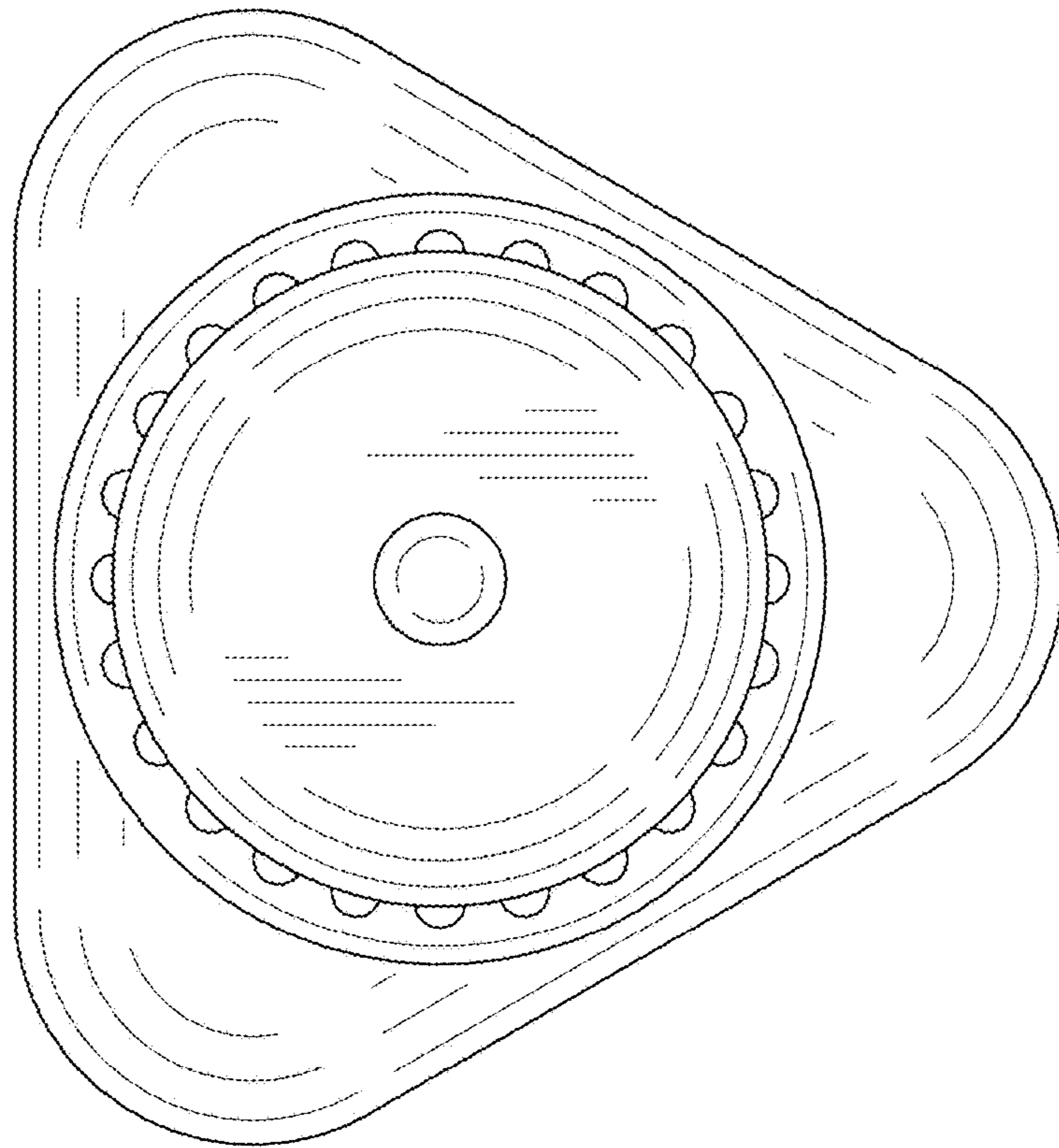

FIG. 22

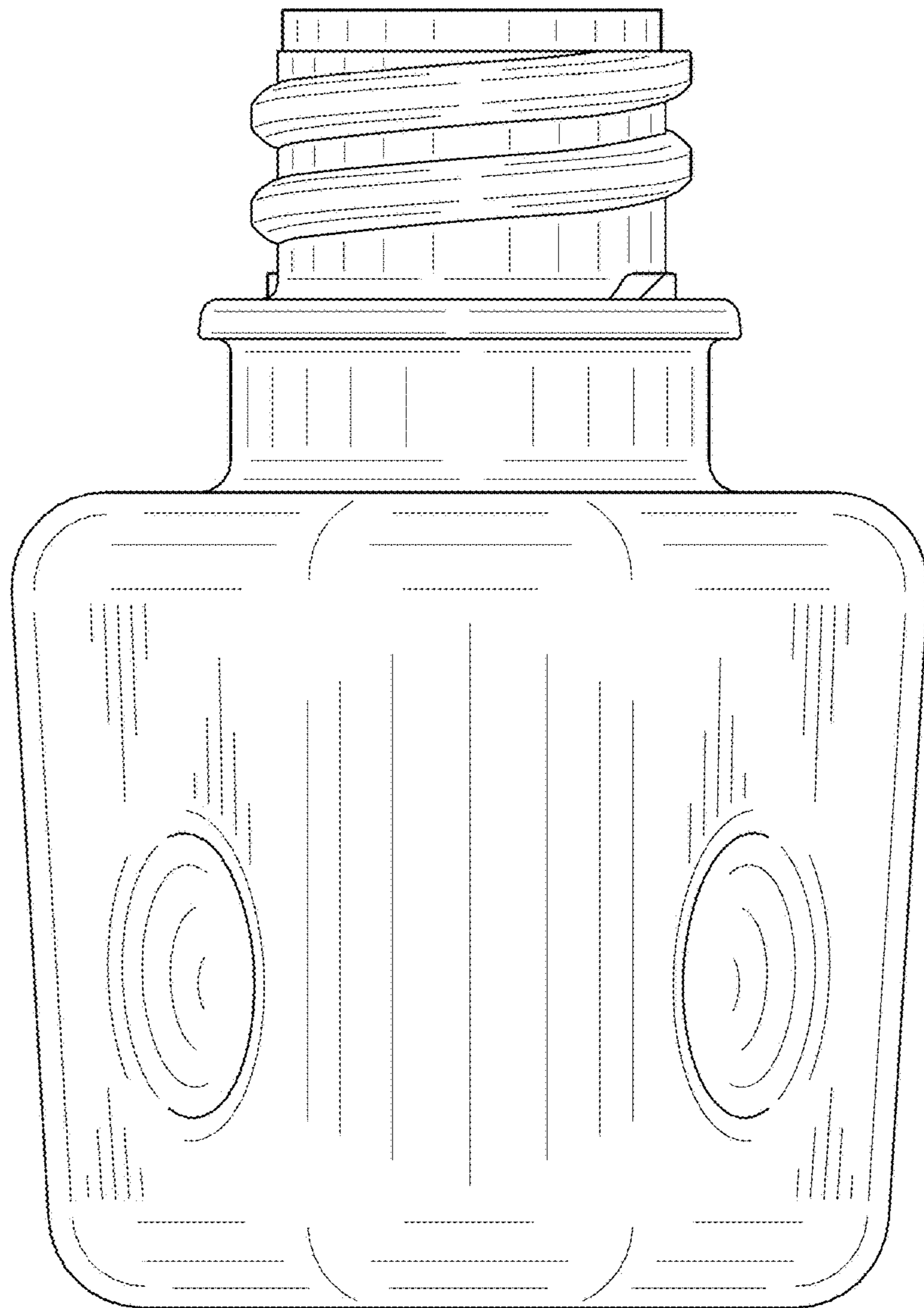

FIG. 23

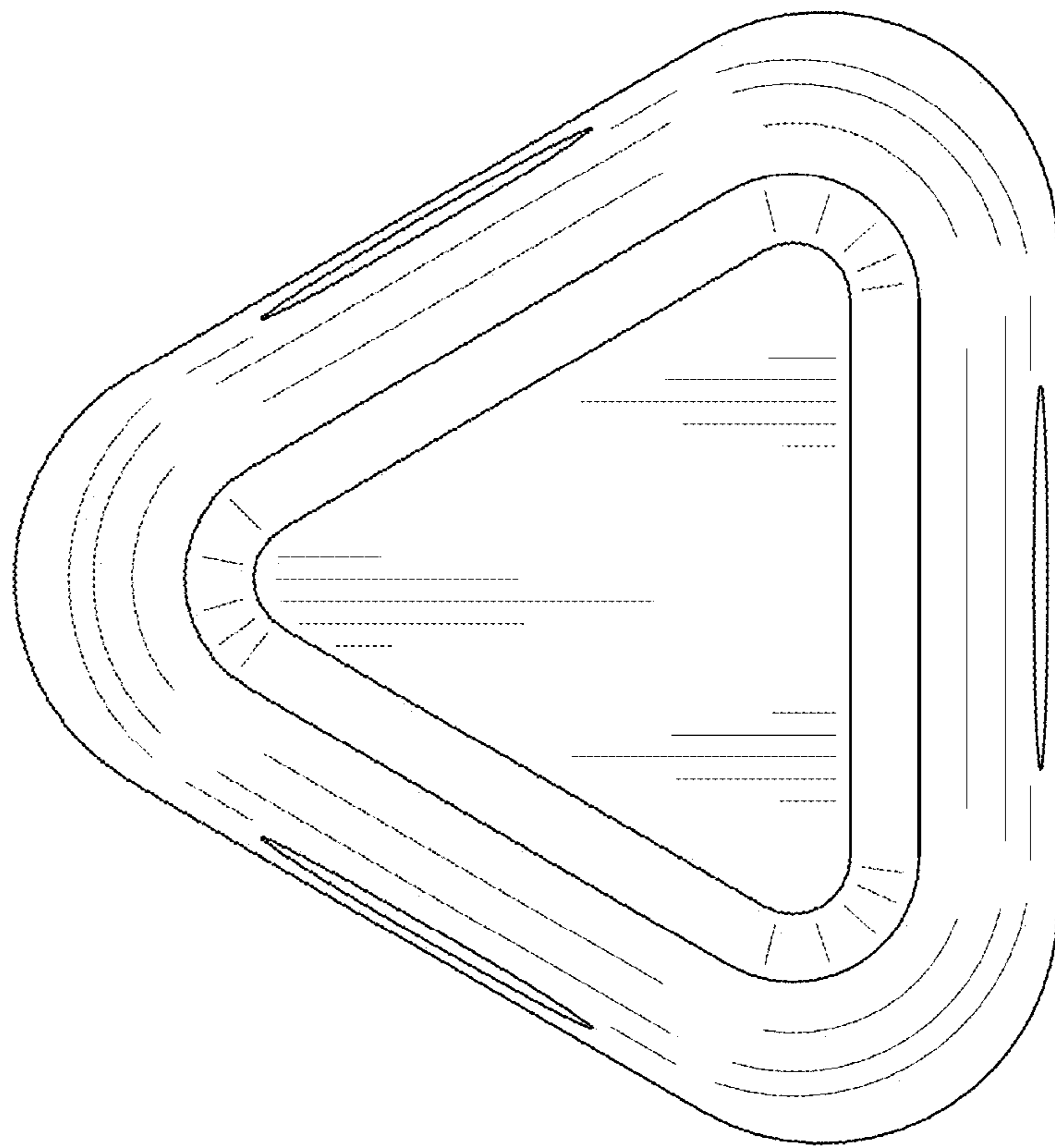

FIG. 24

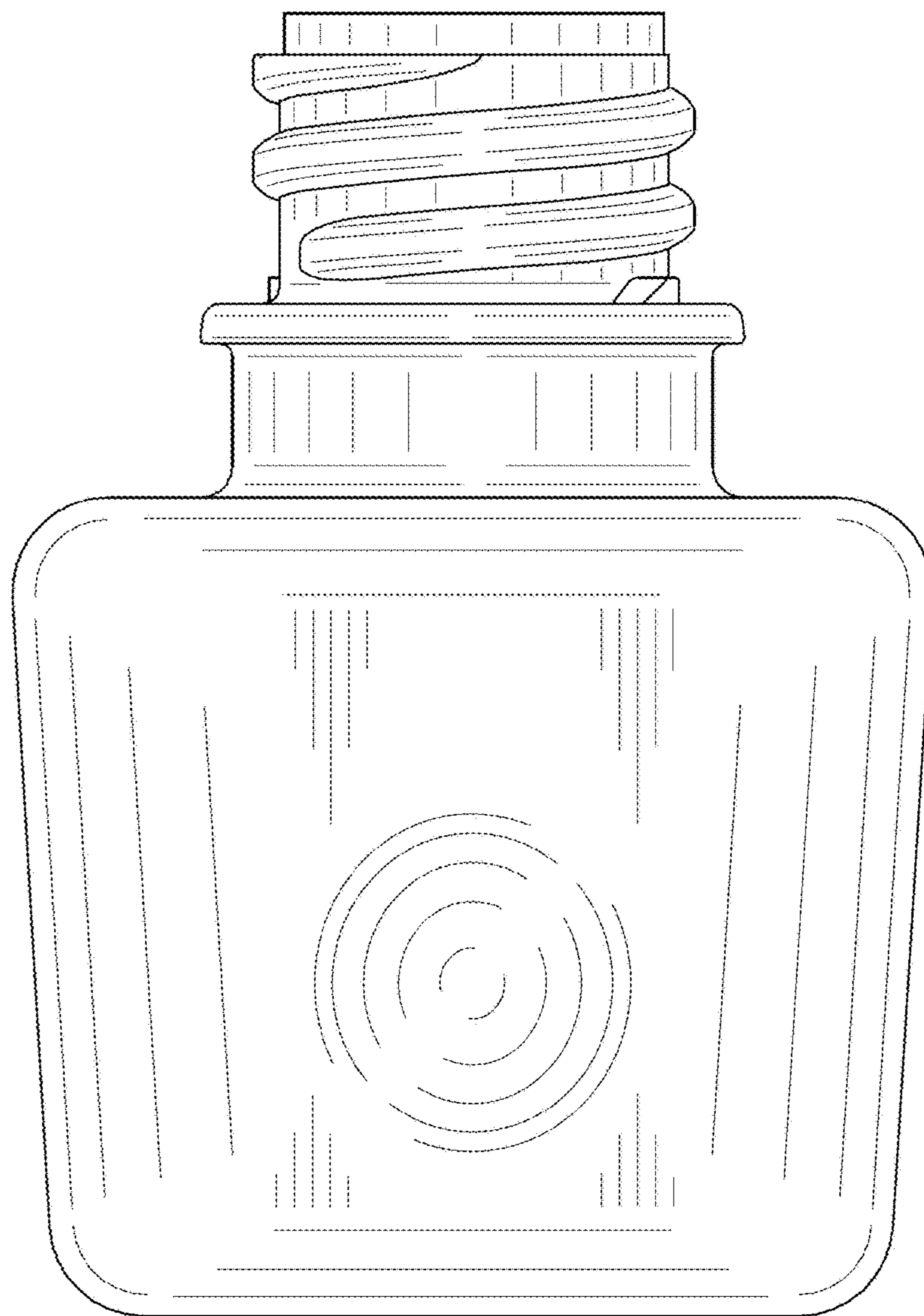

FIG. 25

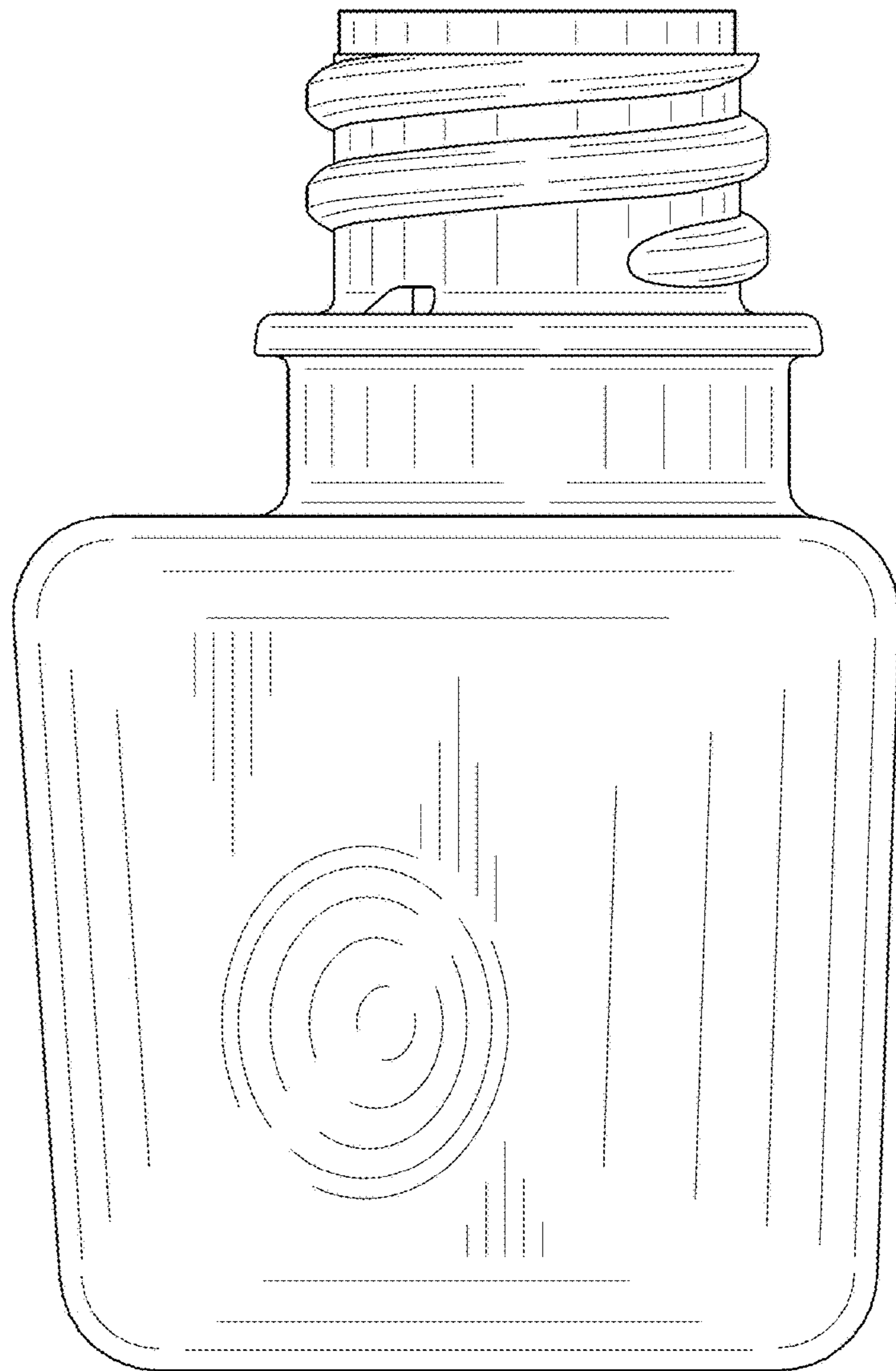

FIG. 26

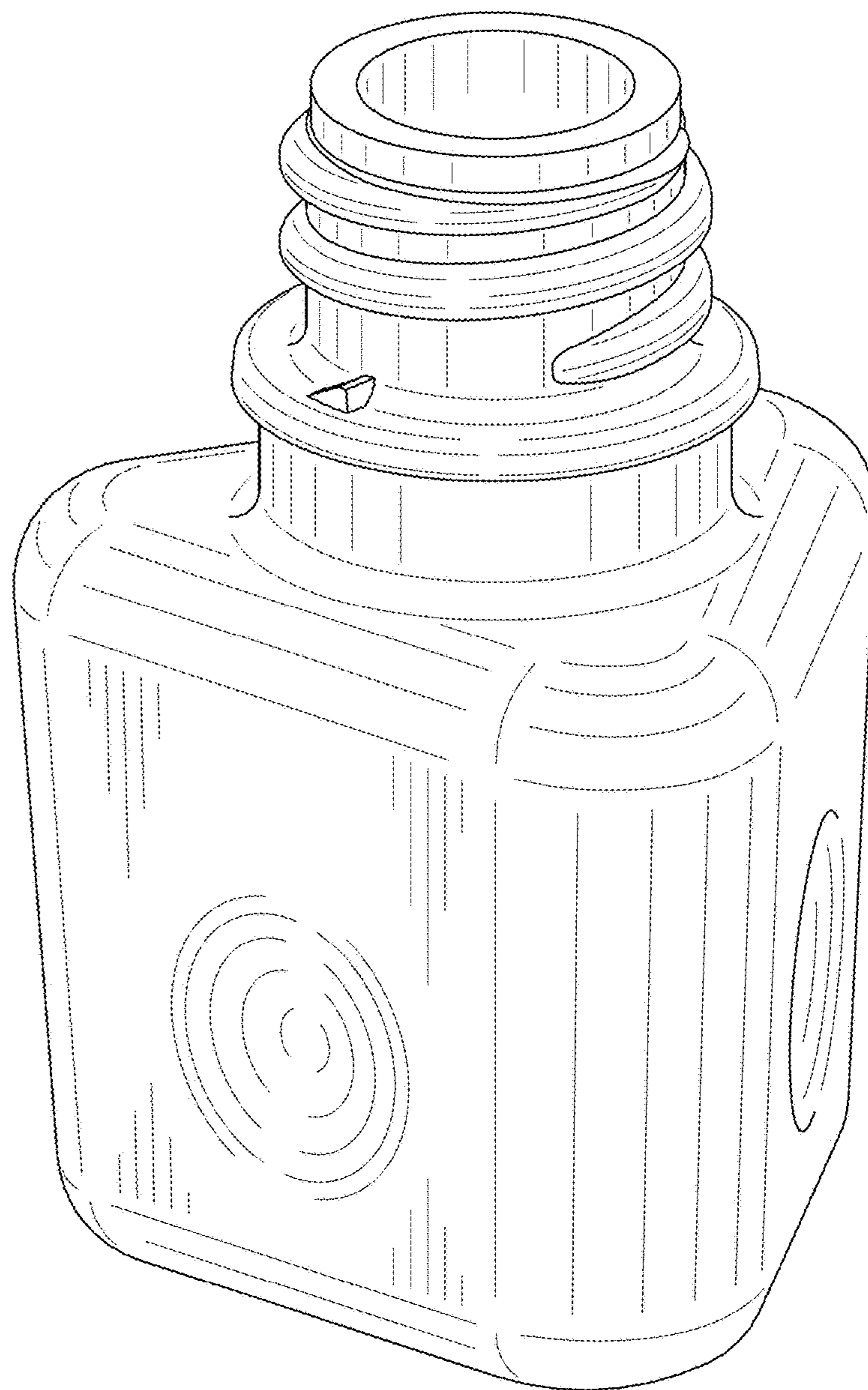

FIG. 27

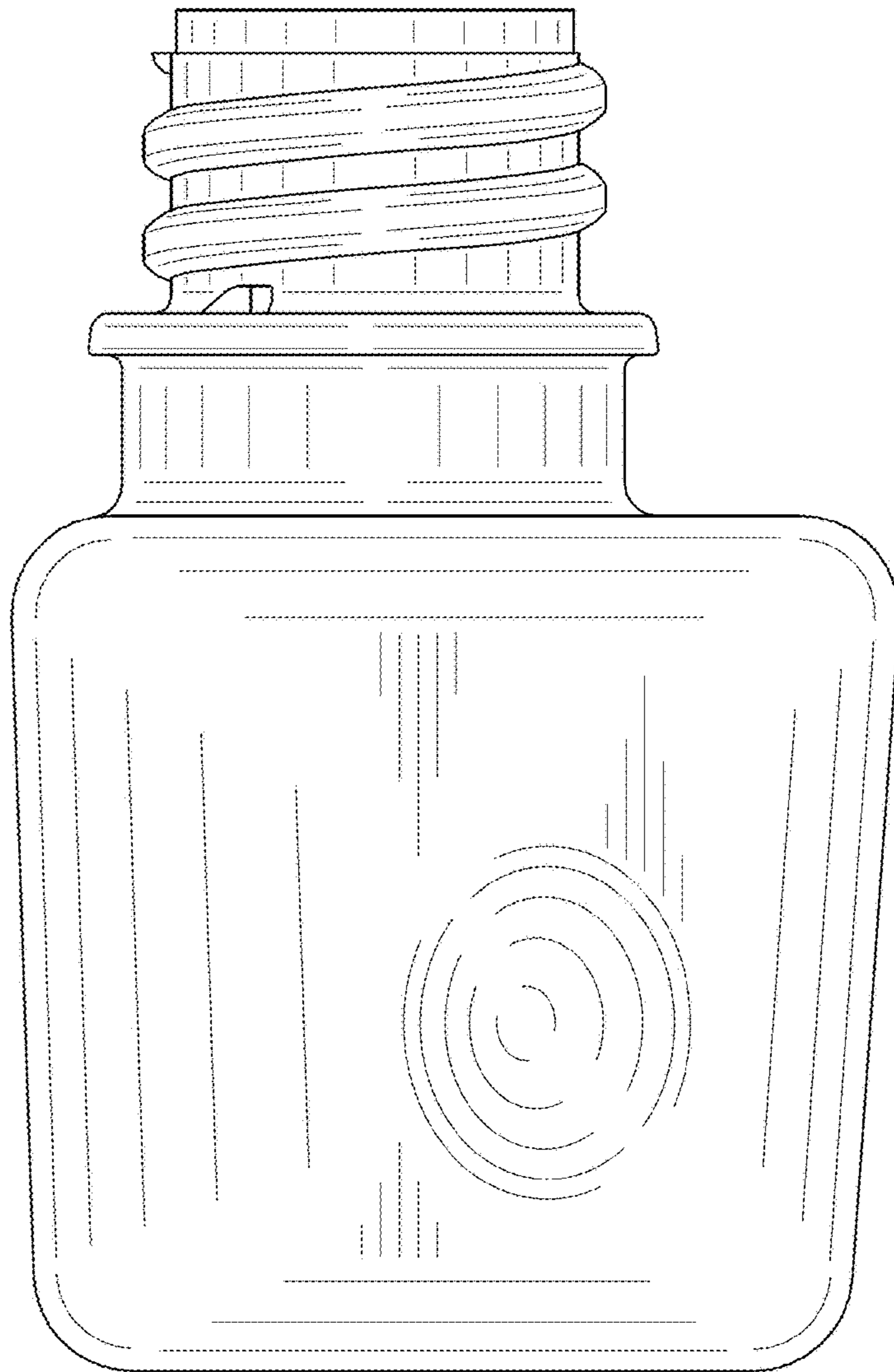

FIG. 28

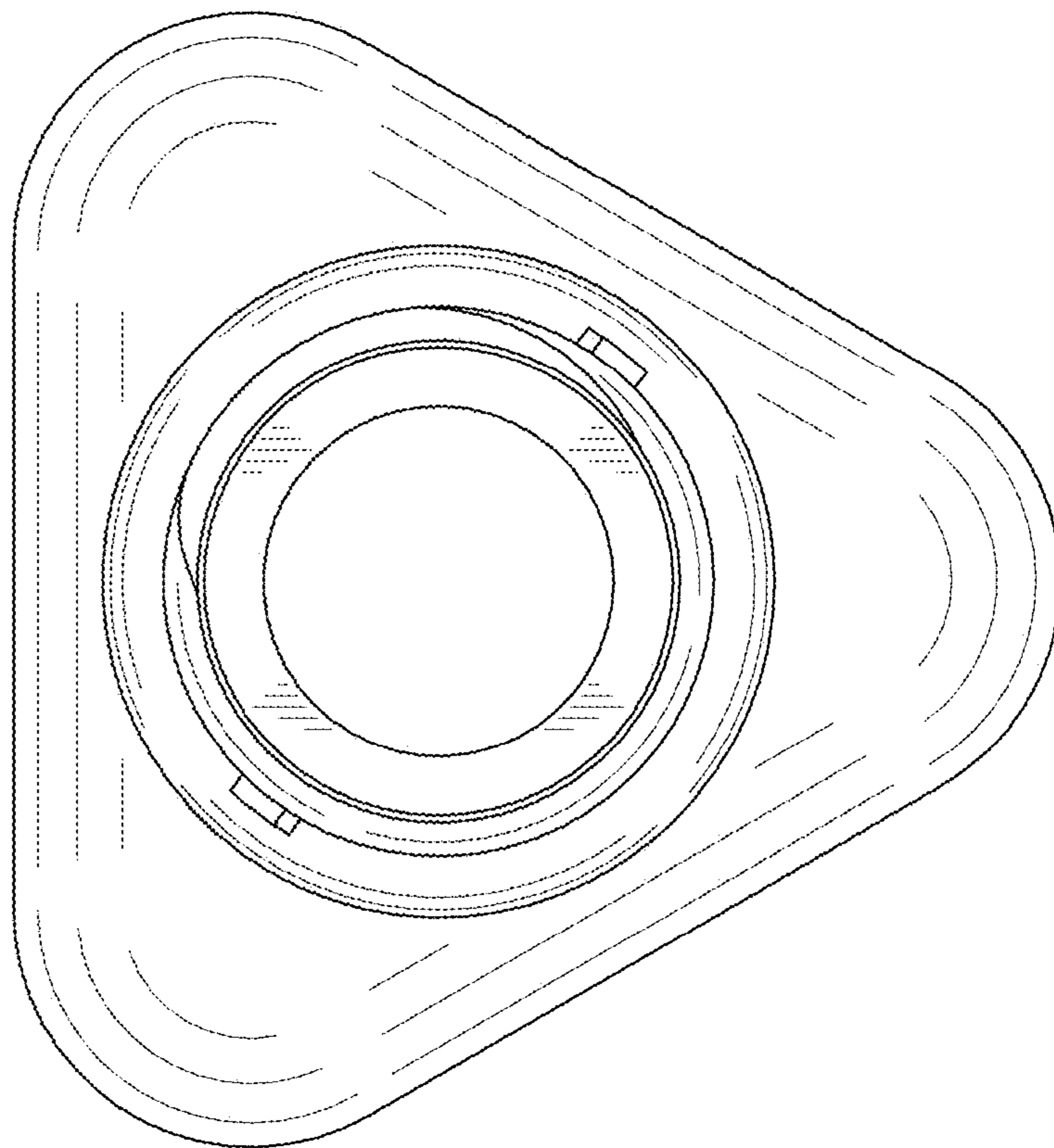

FIG. 29

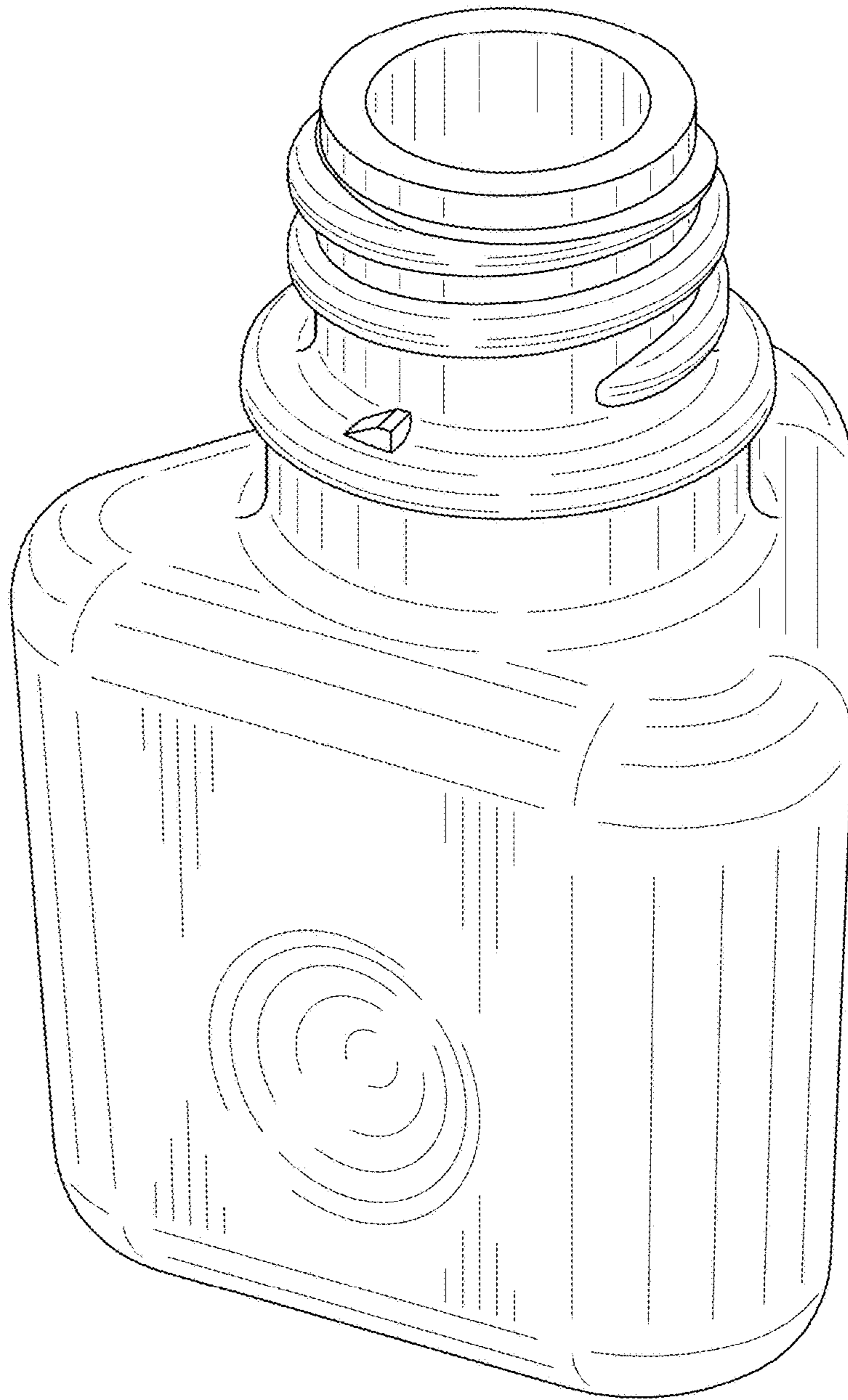

FIG. 30