



US00D803663S

(12) **United States Design Patent** (10) **Patent No.:** **US D803,663 S**  
**Zou** (45) **Date of Patent:** **\*\* Nov. 28, 2017**

(54) **BRACKET**

*Primary Examiner* — Mark Goodwin

(71) Applicant: **Green Inova Lighting Technology Limited**, Baoan District, Shenzhen (CN)

(74) *Attorney, Agent, or Firm* — Meunier Carlin & Curfman LLC

(72) Inventor: **Xiaofeng Zou**, Shenzhen (CN)

(57) **CLAIM**

The ornamental design for a bracket, as shown and described.

(73) Assignee: **Green Inova Lighting Technology Limited**, Shenzhen (CN)

**DESCRIPTION**

(\*\*) Term: **15 Years**

FIG. 1 is a rear perspective view of a bracket showing my new design according to one implementation.

(21) Appl. No.: **29/527,327**

FIG. 2 is a front perspective view of the bracket in FIG. 1.

(22) Filed: **May 18, 2015**

FIG. 3 is a rear view of the bracket in FIG. 1.

(30) **Foreign Application Priority Data**

Nov. 20, 2014 (CN) ..... 2014 3 0461155  
Jan. 30, 2015 (CN) ..... 2015 3 0029456

FIG. 4 is a front view of the bracket in FIG. 1.

(Continued)

FIG. 5 is a left side view of the bracket in FIG. 1. The right side view of the bracket in FIG. 1 is a mirror image of the left side view.

(51) **LOC (10) Cl.** ..... **08-08**

FIG. 6 is a top view of the bracket in FIG. 1.

(52) **U.S. Cl.**  
USPC ..... **D8/349**

FIG. 7 is a bottom view of the bracket in FIG. 1.

(58) **Field of Classification Search**  
USPC ..... D8/349, 354, 363, 355, 364, 366, 371, D8/373, 380, 381; D14/451, 452;  
(Continued)

FIG. 8 is a rear perspective view of the bracket according to another implementation.

(56) **References Cited**

**U.S. PATENT DOCUMENTS**

D259,242 S \* 5/1981 Gilb ..... D8/373  
D312,700 S 12/1990 Suzuki et al.

FIG. 9 is a front perspective view of the bracket in FIG. 8.

(Continued)

FIG. 10 is a rear view of the bracket in FIG. 8.

FIG. 11 is a front view of the bracket in FIG. 8.

**OTHER PUBLICATIONS**

Spike Heat Sink round, available Sep. 11, 2009. See URL [http://www.led-tech.de/en/High-Power-Supply/Coolers/Spike-Heat-Sink-round-32.5mm-LT-1539\\_106\\_114.html](http://www.led-tech.de/en/High-Power-Supply/Coolers/Spike-Heat-Sink-round-32.5mm-LT-1539_106_114.html).

FIG. 12 is a right side view of the bracket in FIG. 8. The left side view of the bracket in FIG. 8 is a mirror image of the right side view.

(Continued)

FIG. 13 is a top view of the bracket in FIG. 8.

FIG. 14 is a bottom view of the bracket in FIG. 8.

FIG. 15 is a rear perspective view of the bracket according to yet another implementation.

FIG. 16 is a front perspective view of the bracket in FIG. 15.

FIG. 17 is a rear view of the bracket in FIG. 15.

FIG. 18 is a front view of the bracket in FIG. 15.

FIG. 19 is a left side view of the bracket in FIG. 15. The right side view of the bracket in FIG. 15 is a mirror image of the left side view.

FIG. 20 is a top view of the bracket in FIG. 15.

FIG. 21 is a bottom view of the bracket in FIG. 15.

FIG. 22 is a rear perspective view of the bracket according to another implementation.

FIG. 23 is a front perspective view of the bracket in FIG. 22.

FIG. 24 is a rear view of the bracket in FIG. 22.

(Continued)

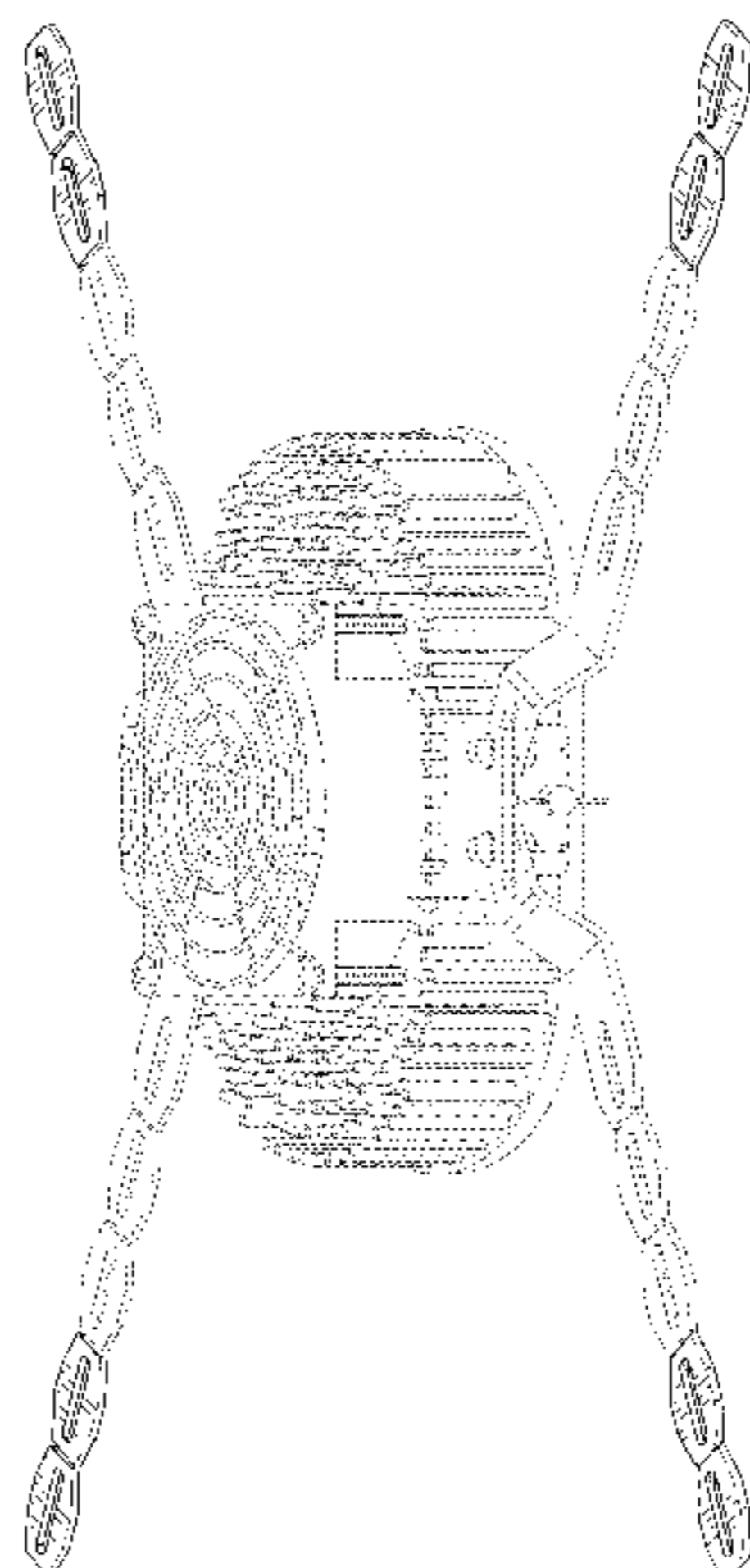

FIG. 25 is a front view of the bracket in FIG. 22.  
 FIG. 26 is a left side view of the bracket in FIG. 22. The right side view of the bracket in FIG. 22 is a mirror image of the left side view.  
 FIG. 27 is a top view of the bracket in FIG. 22; and,  
 FIG. 28 is a bottom view of the bracket in FIG. 22.  
 The broken lines, showing the remaining portions of the bracket and its environment, form no part of the claimed design.

**1 Claim, 24 Drawing Sheets**

(30) **Foreign Application Priority Data**

Jan. 30, 2015 (CN) ..... 2015 3 0029661  
 Apr. 30, 2015 (CN) ..... 2015 3 0122978

(58) **Field of Classification Search**

USPC ..... 248/222.11, 274.1, 278.1, 284.1, 220.22,  
 248/221.11, 221.12, 222.13, 222.41,  
 248/223.31, 223.41, 224.51, 224.61,  
 248/224.8, 225.11, 316.2, 407, 346.03,  
 248/346.04, 346.06, 177.1, 178.1, 187.1;  
 224/547, 548, 554, 567, 571  
 CPC ..... B60R 2011/0059; B60R 2011/0061; B60R  
 2011/0073; B60R 2011/0078; B60R  
 2011/0084; F16M 11/041; F16M 13/02;  
 F16M 2200/02; B60P 7/0807; B60P  
 7/0815; F16B 2/14; A61B 90/50

See application file for complete search history.

(56) **References Cited**

U.S. PATENT DOCUMENTS

5,276,585 A 1/1994 Smithers  
 5,369,301 A 11/1994 Hayashi et al.  
 D386,388 S \* 11/1997 Antonucci ..... D8/354  
 D398,295 S 9/1998 Chang  
 D422,894 S \* 4/2000 Kubica ..... D8/382  
 D436,677 S 1/2001 Huo-Tu  
 D486,724 S \* 2/2004 Bently ..... D8/354  
 D536,603 S \* 2/2007 Worrall ..... D8/363  
 D553,656 S 10/2007 Reeves et al.

D557,126 S \* 12/2007 Worrall ..... D14/452  
 D560,470 S \* 1/2008 Short ..... D8/354  
 D579,319 S \* 10/2008 Short ..... D8/354  
 D580,741 S \* 11/2008 Short ..... D8/354  
 D580,743 S \* 11/2008 Short ..... D14/452  
 D581,252 S \* 11/2008 Short ..... D8/354  
 D582,399 S \* 12/2008 Venier ..... D14/224  
 D587,273 S \* 2/2009 Sculler ..... D14/239  
 D603,810 S 11/2009 Yang et al.  
 D634,280 S 3/2011 Chua et al.  
 D641,610 S \* 7/2011 Sedalo ..... D8/354  
 D658,038 S \* 4/2012 Ghatikar ..... D8/354  
 D658,039 S \* 4/2012 Ghatikar ..... D8/354  
 D658,040 S \* 4/2012 Ghatikar ..... D8/354  
 D665,743 S 8/2012 Hinkel  
 D713,983 S 9/2014 Yang  
 D715,622 S \* 10/2014 Qu ..... D8/349  
 8,864,360 B2 10/2014 Parker et al.  
 D719,537 S 12/2014 Kawase et al.  
 D721,573 S \* 1/2015 Fievet ..... D8/382  
 D731,447 S 6/2015 Ward et al.  
 D747,955 S \* 1/2016 Franco ..... D8/354  
 D754,084 S 4/2016 Kawase  
 9,313,923 B2 4/2016 Davis et al.  
 9,360,514 B2 6/2016 Phan et al.  
 9,383,145 B2 7/2016 Weber et al.  
 9,407,163 B2 8/2016 Nakatsu et al.  
 D784,114 S \* 4/2017 Rago ..... D8/354  
 D796,938 S \* 9/2017 Rago ..... D8/354  
 2002/0018338 A1 2/2002 McCullough  
 2004/0011932 A1 \* 1/2004 Duff ..... F16M 11/10  
 248/157  
 2010/0067196 A1 3/2010 Costello et al.  
 2010/0254140 A1 10/2010 Wen et al.  
 2015/0214132 A1 7/2015 Lee  
 2016/0223183 A1 8/2016 Zou et al.

OTHER PUBLICATIONS

Pin fin star heat sink, published May 13, 2014. See URL: <https://www.youtube.com/watch?v=1pFJ2rfl688>.  
 Co-pending Design U.S. Appl. No. 29/527,400, filed May 19, 2015, and its file history.  
 Co-pending Design U.S. Appl. No. 29/527,403, filed May 19, 2015, and its file history.  
 Office Action received in Design U.S. Appl. No. 29/527,400, dated Sep. 13, 2016.  
 Office Action received in Design U.S. Appl. No. 29/527,403, dated Sep. 1, 2016.

\* cited by examiner

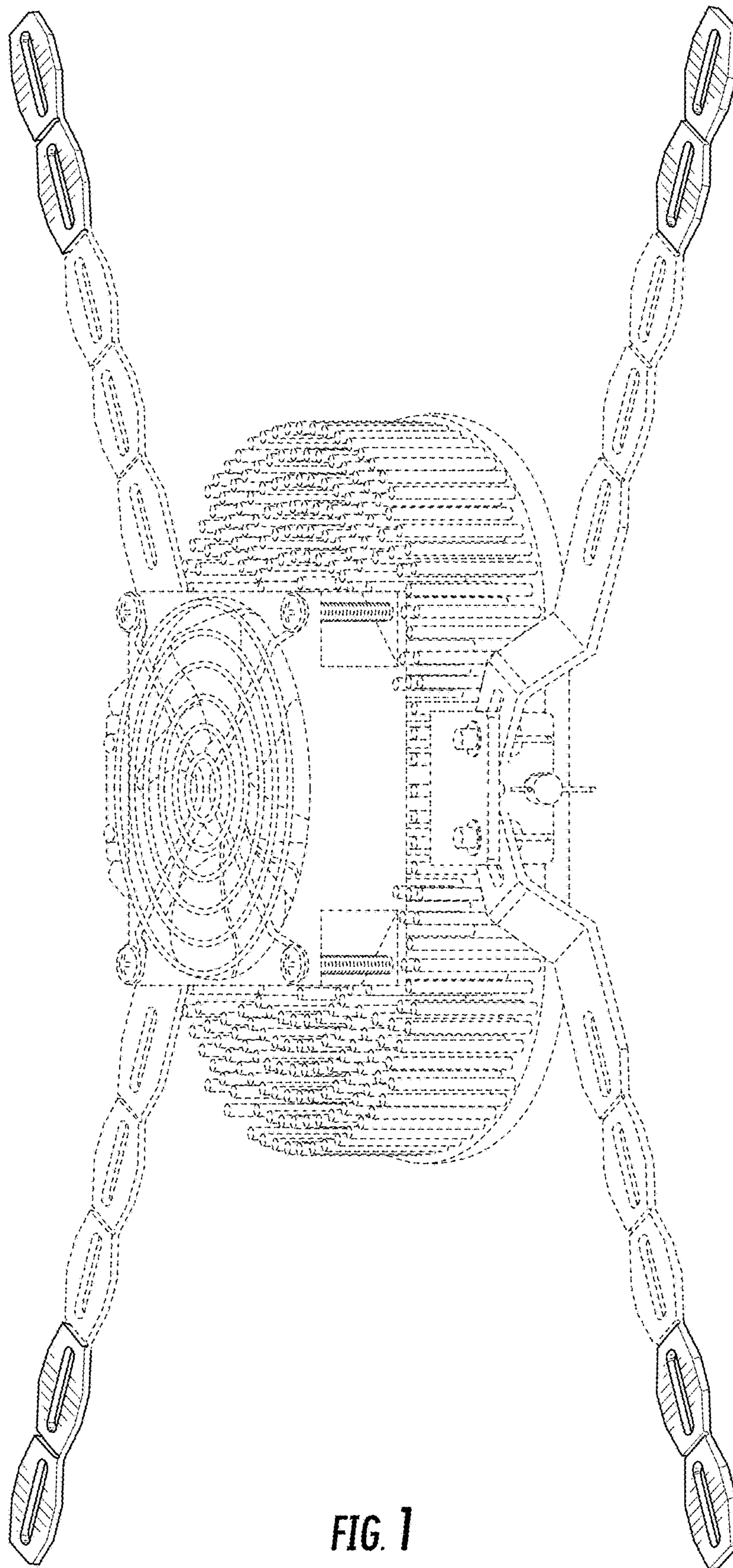

FIG. 1

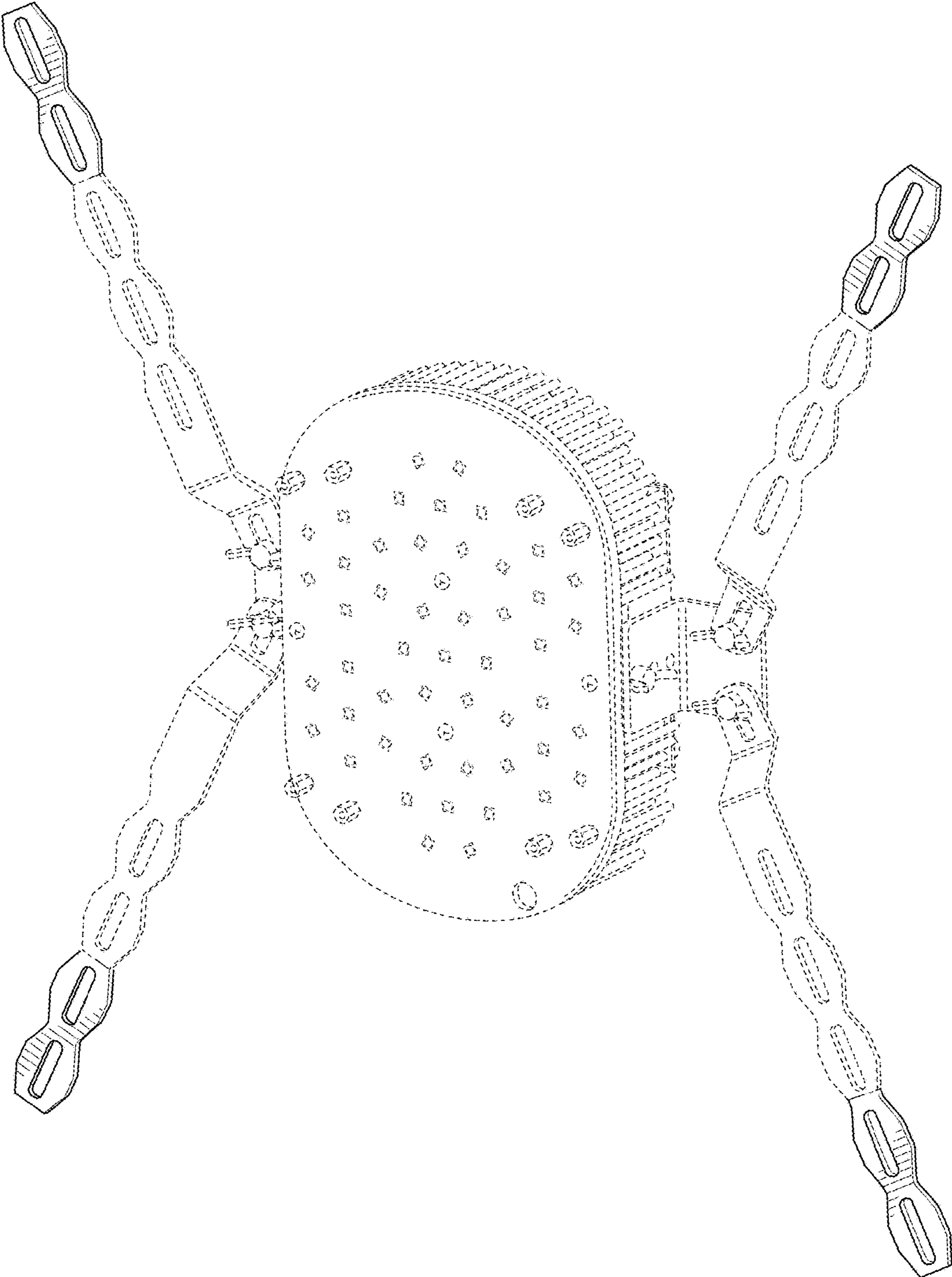

FIG. 2

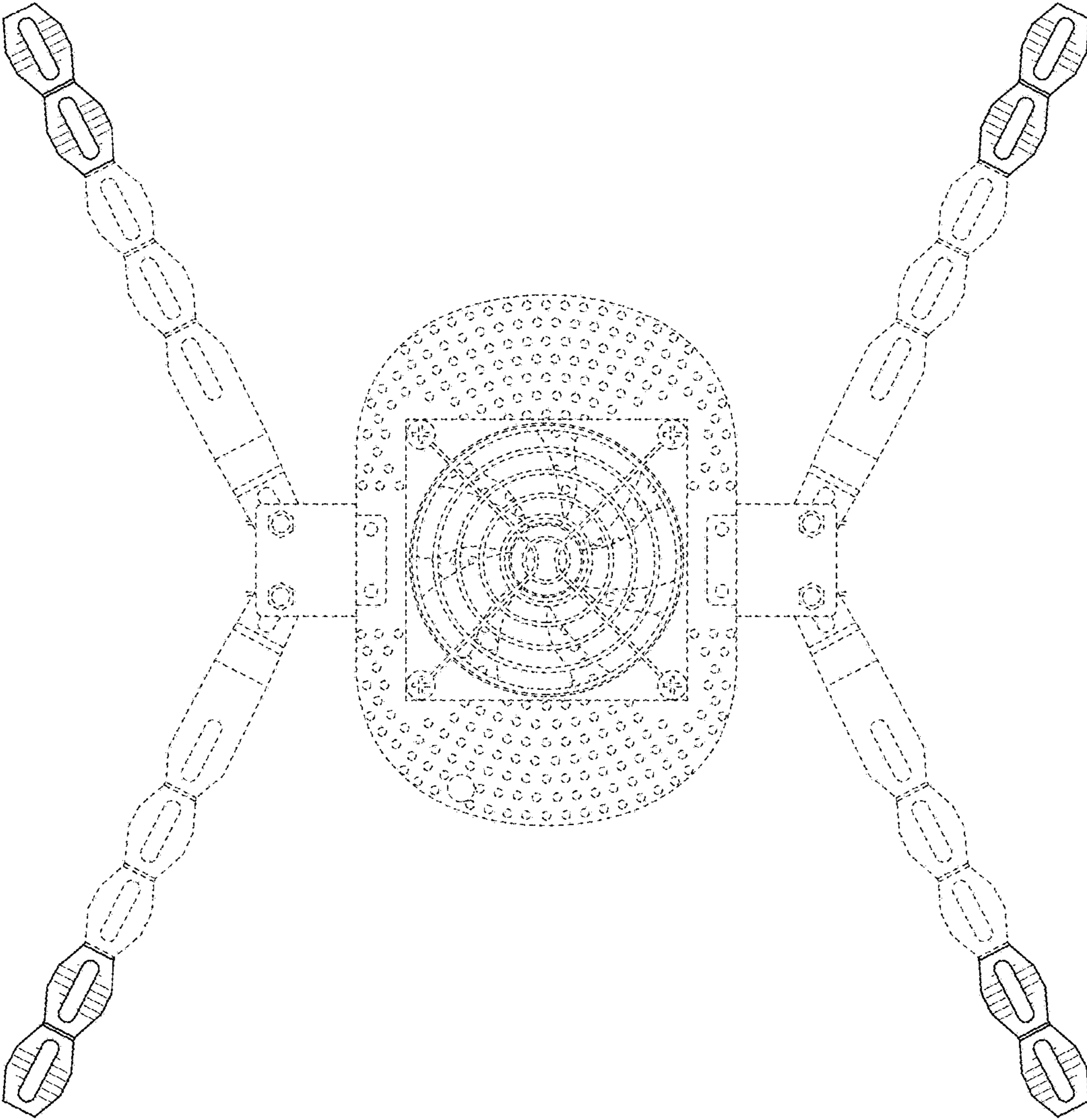

FIG. 3

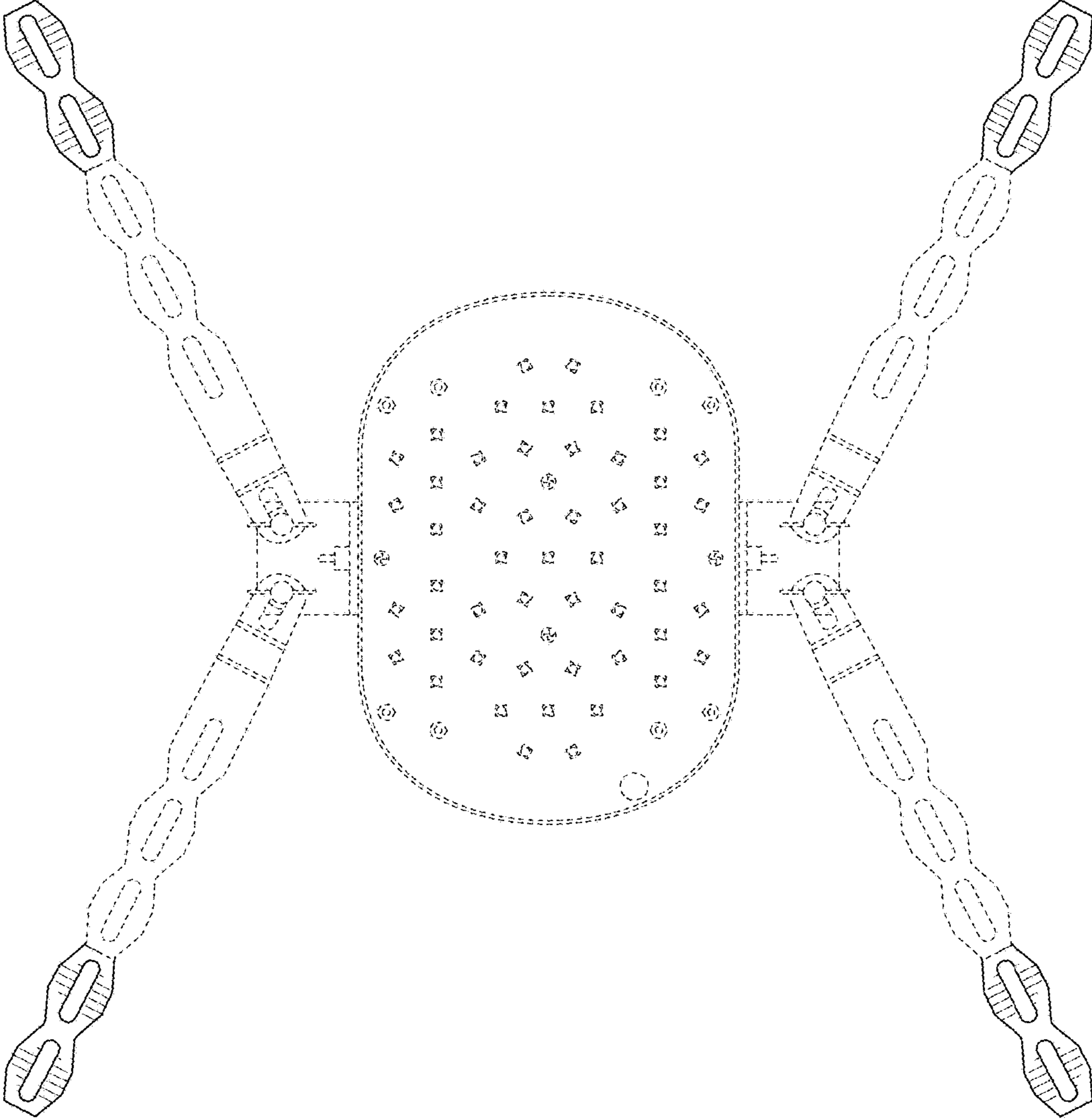

FIG. 4

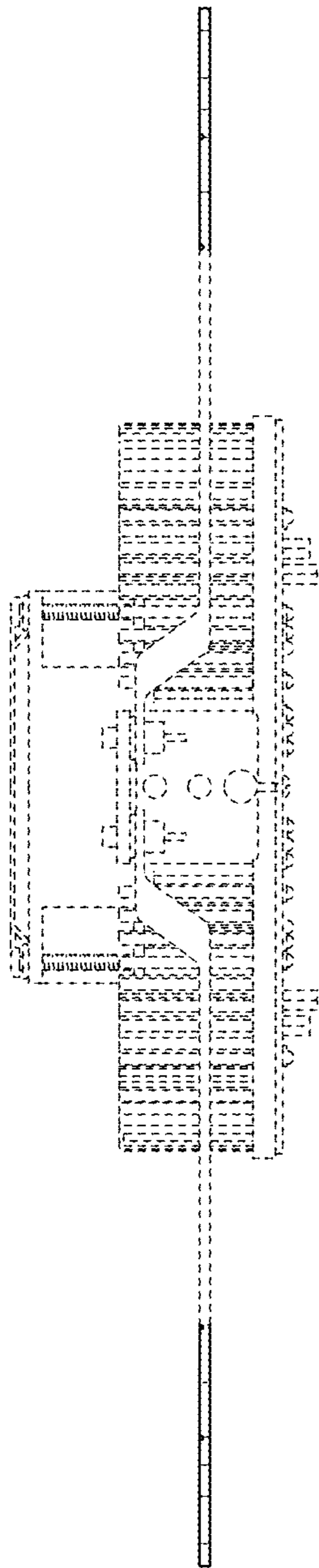

FIG. 5

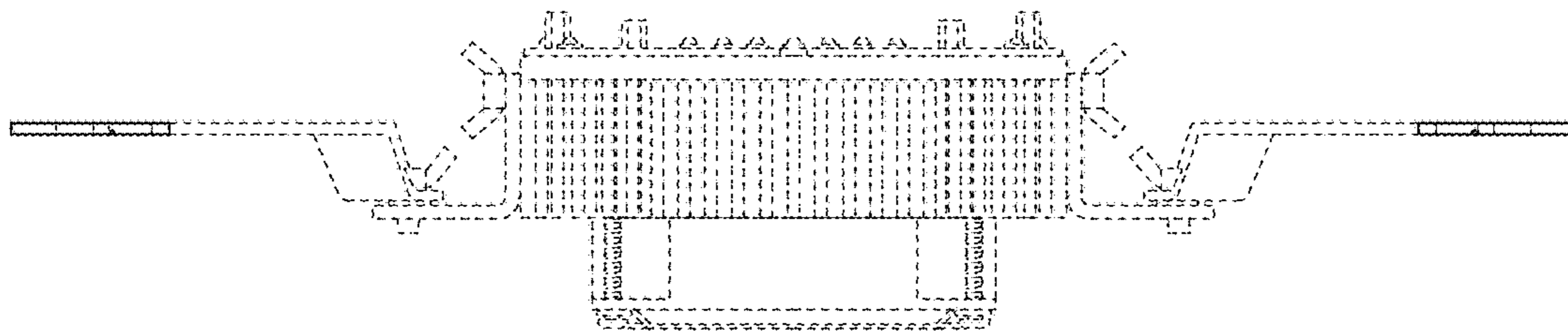

FIG. 6

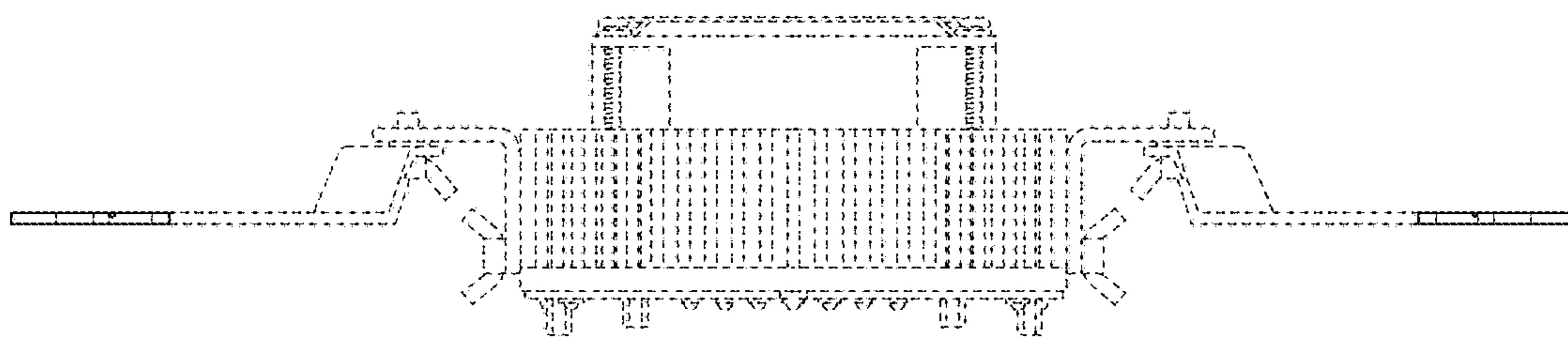

FIG. 7



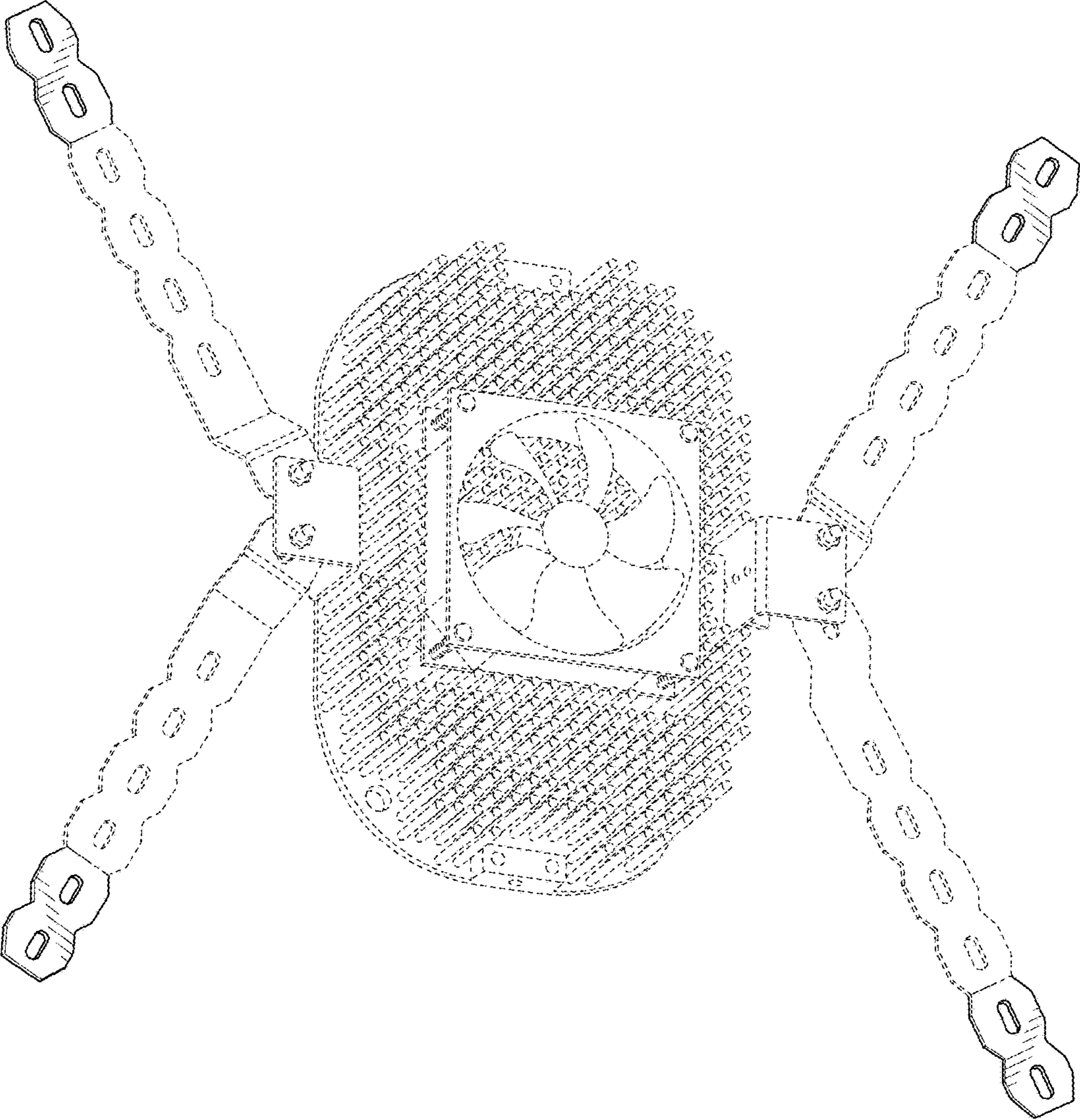

FIG. 8

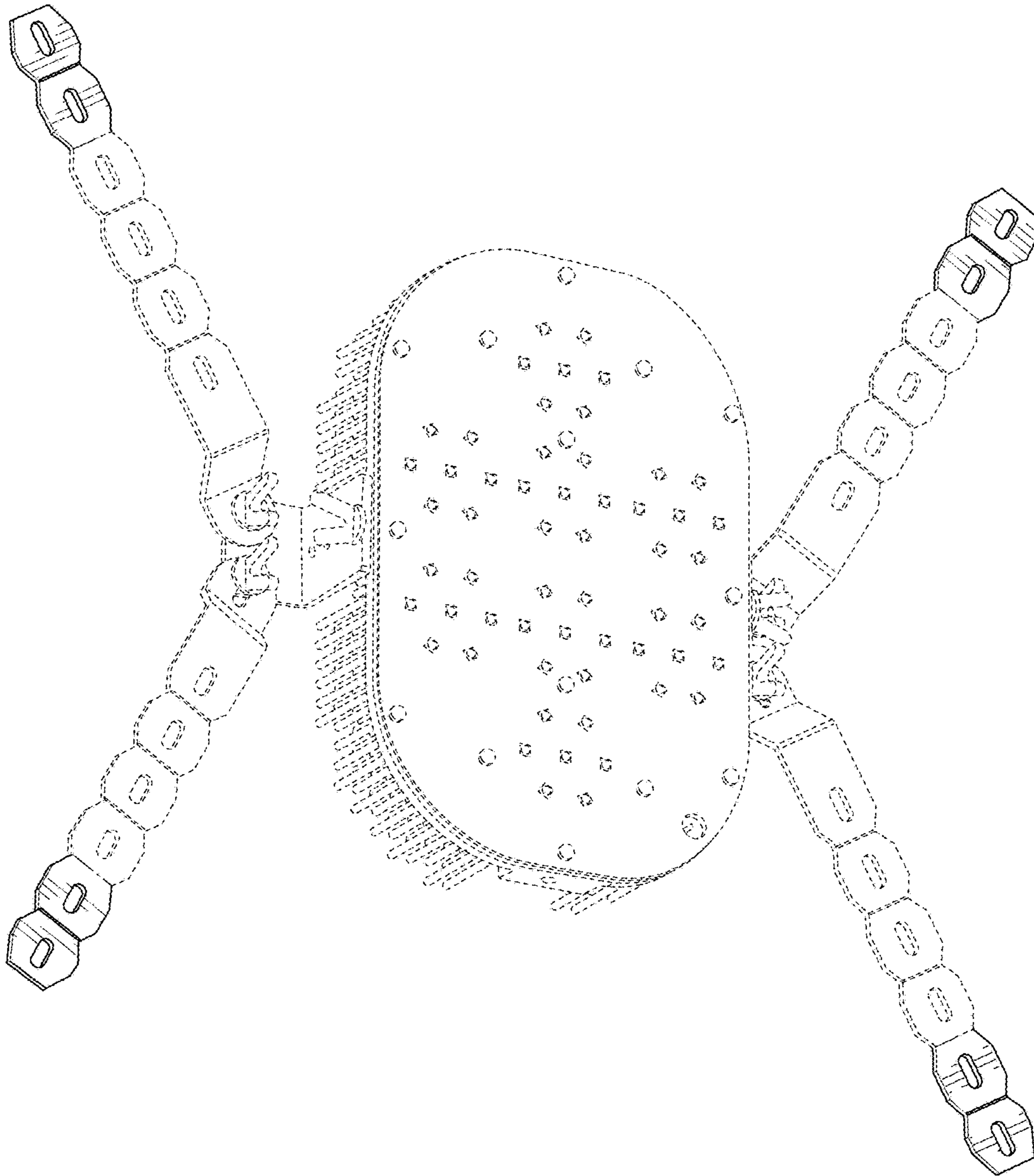

FIG. 9

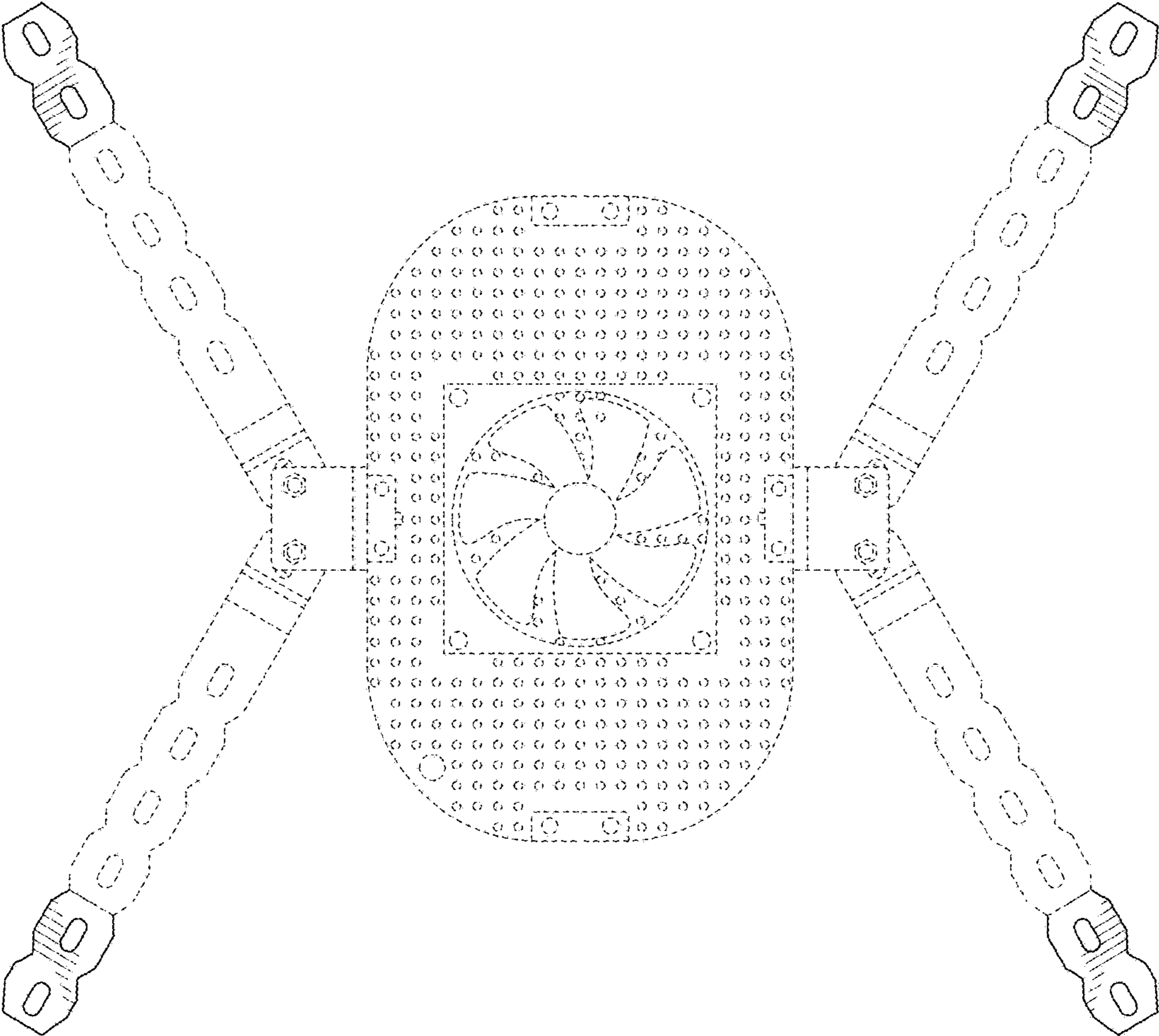

FIG. 10

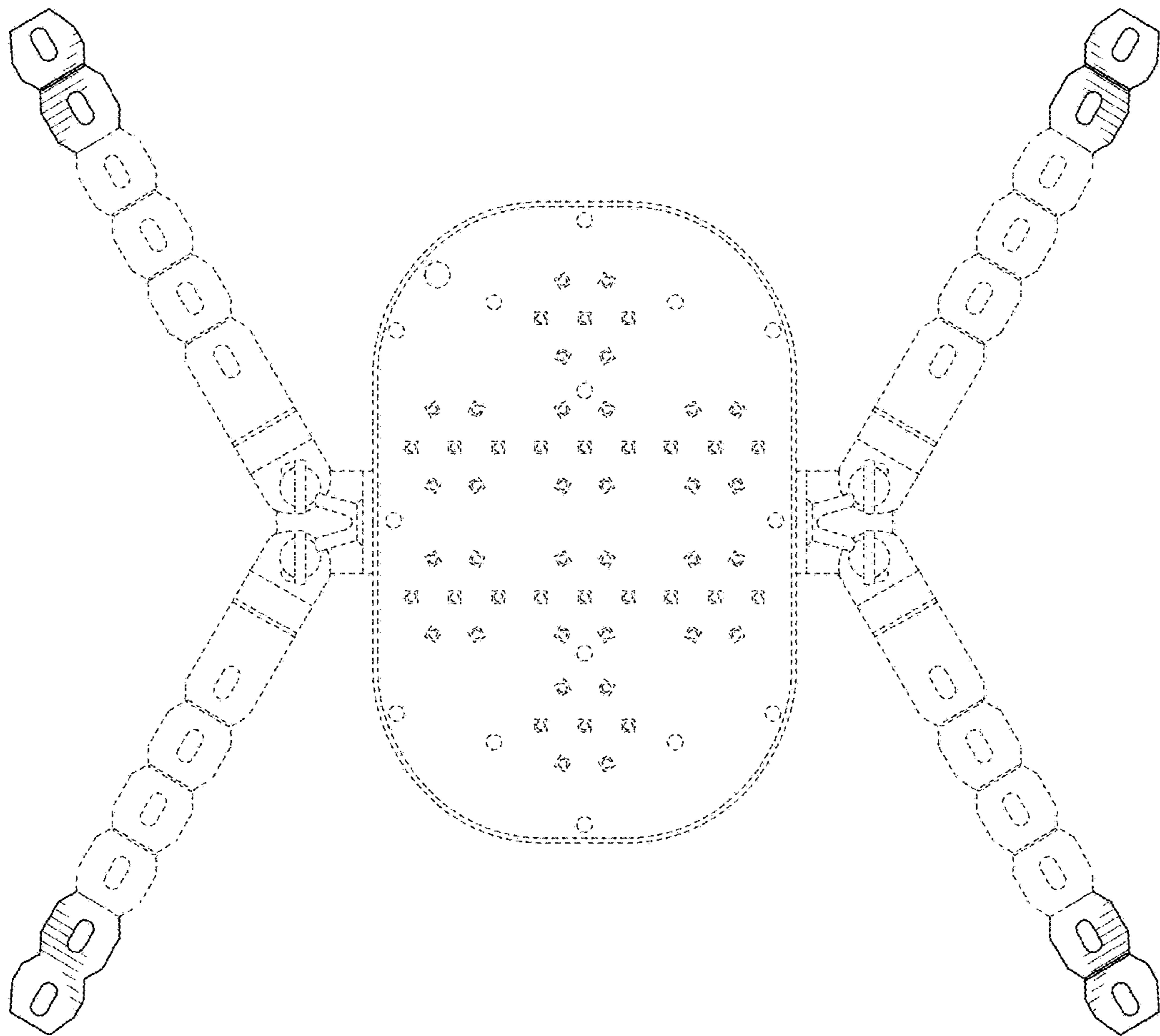

FIG. 11

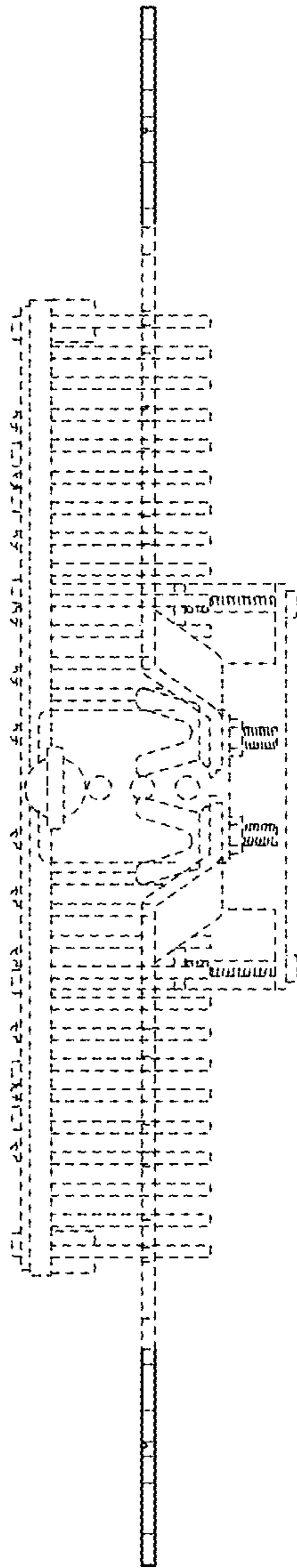

FIG. 12

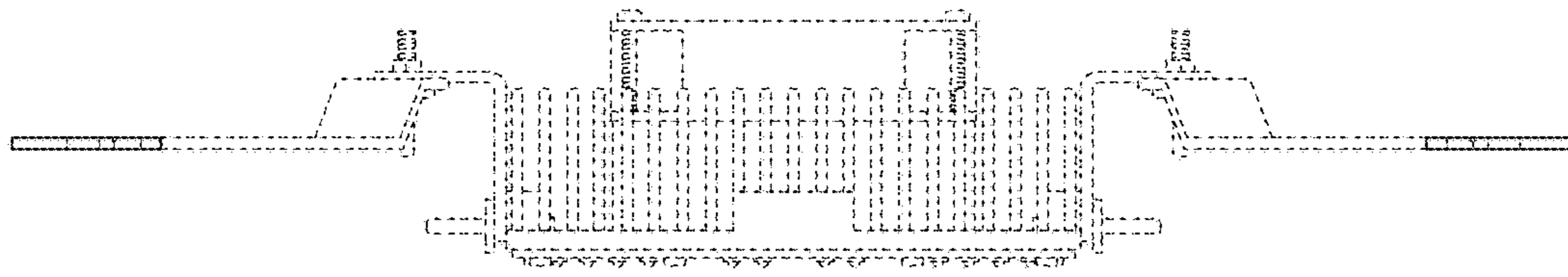

FIG. 13

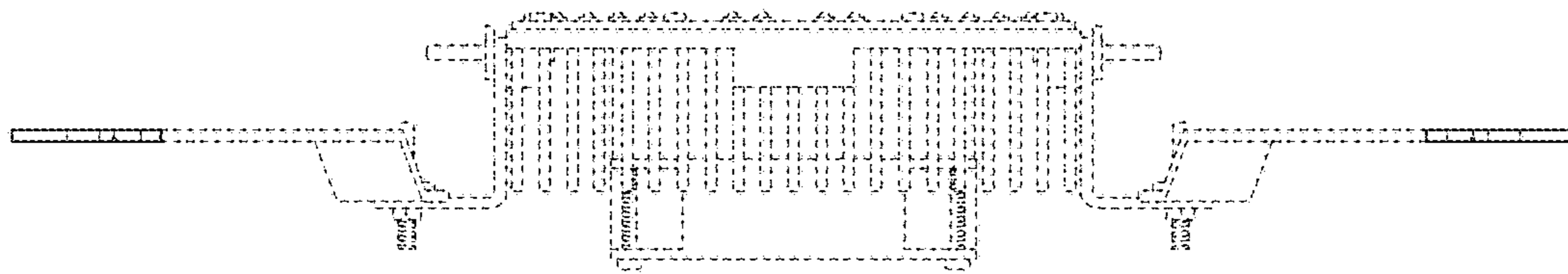

FIG. 14

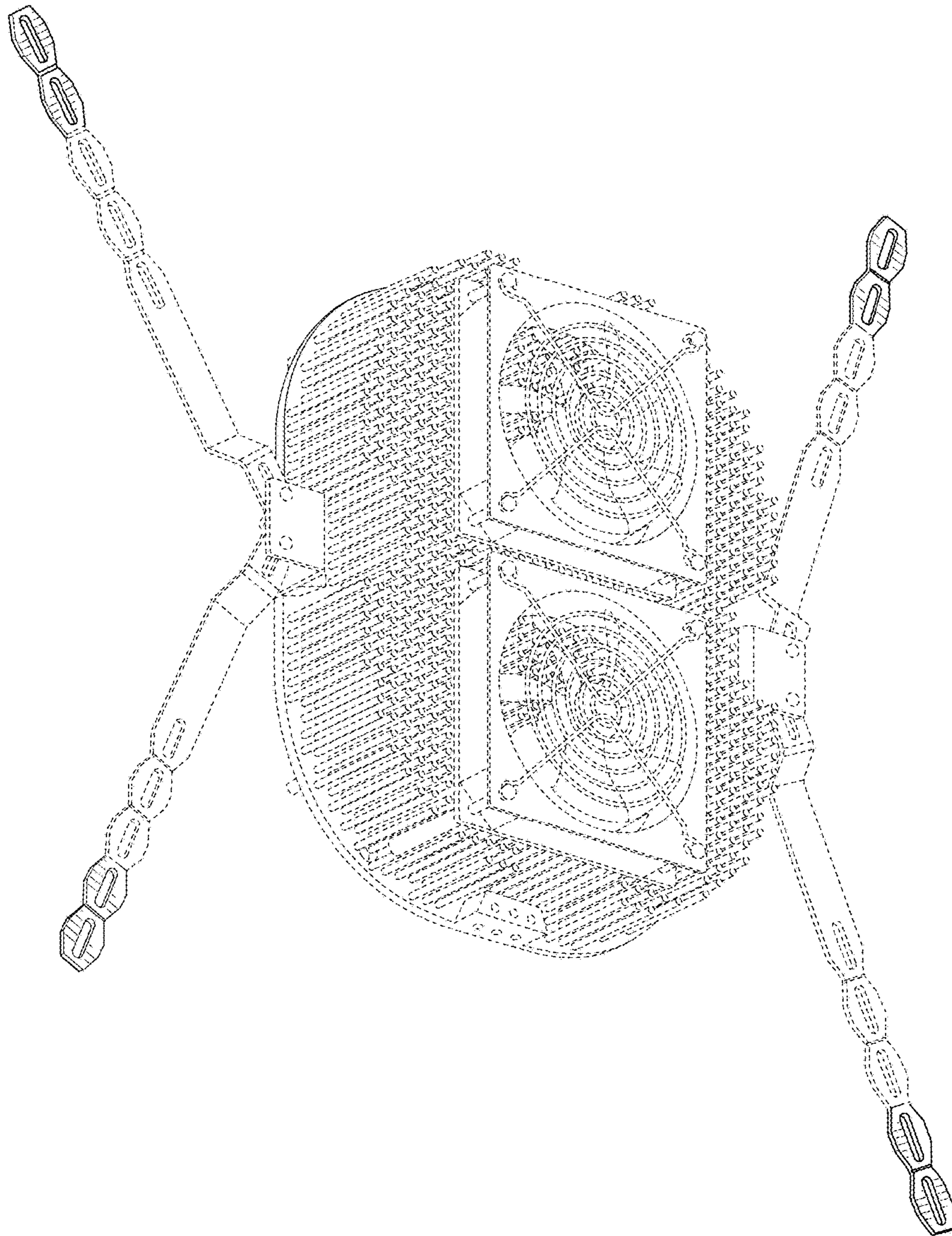

FIG. 15

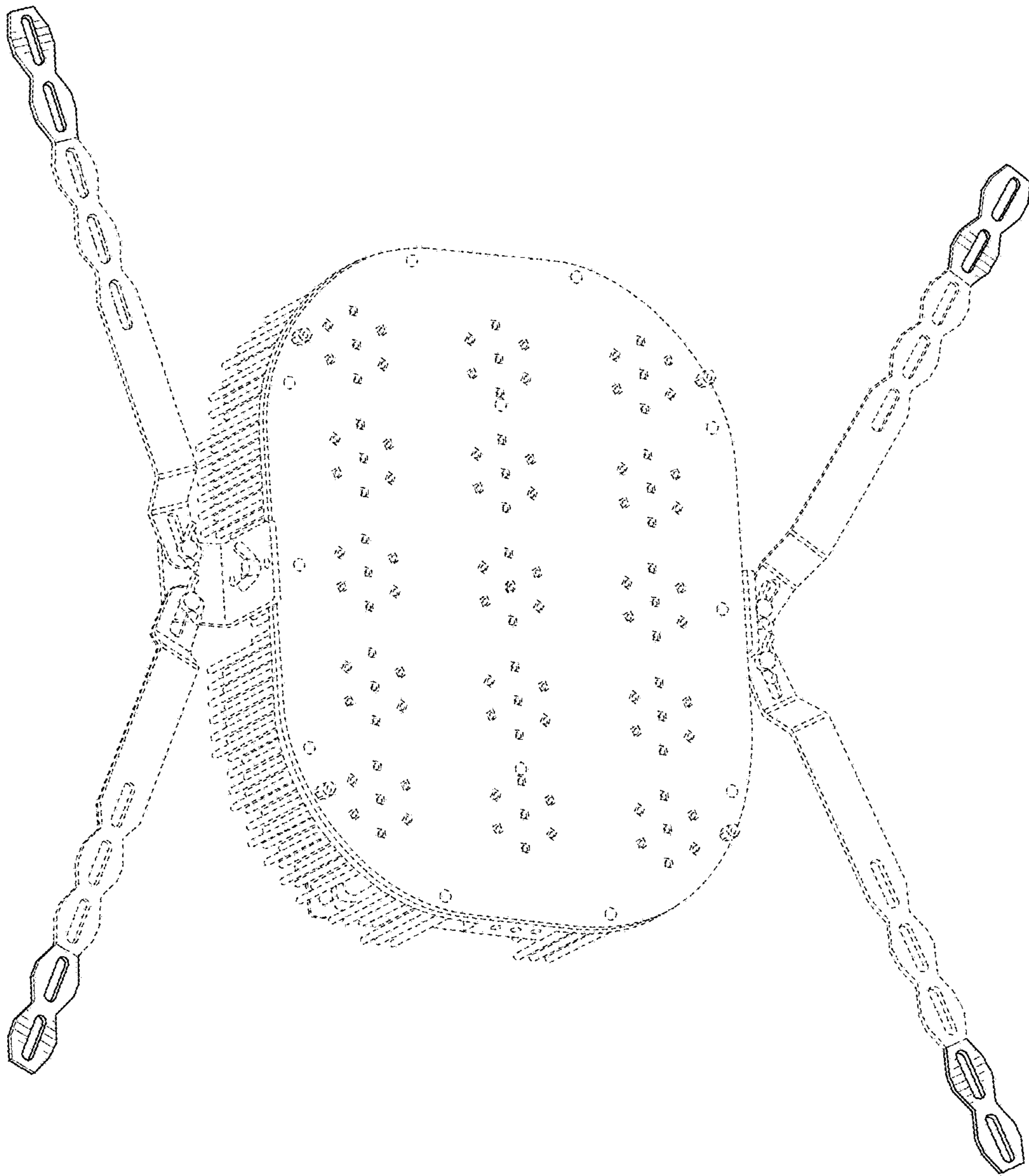

FIG. 16



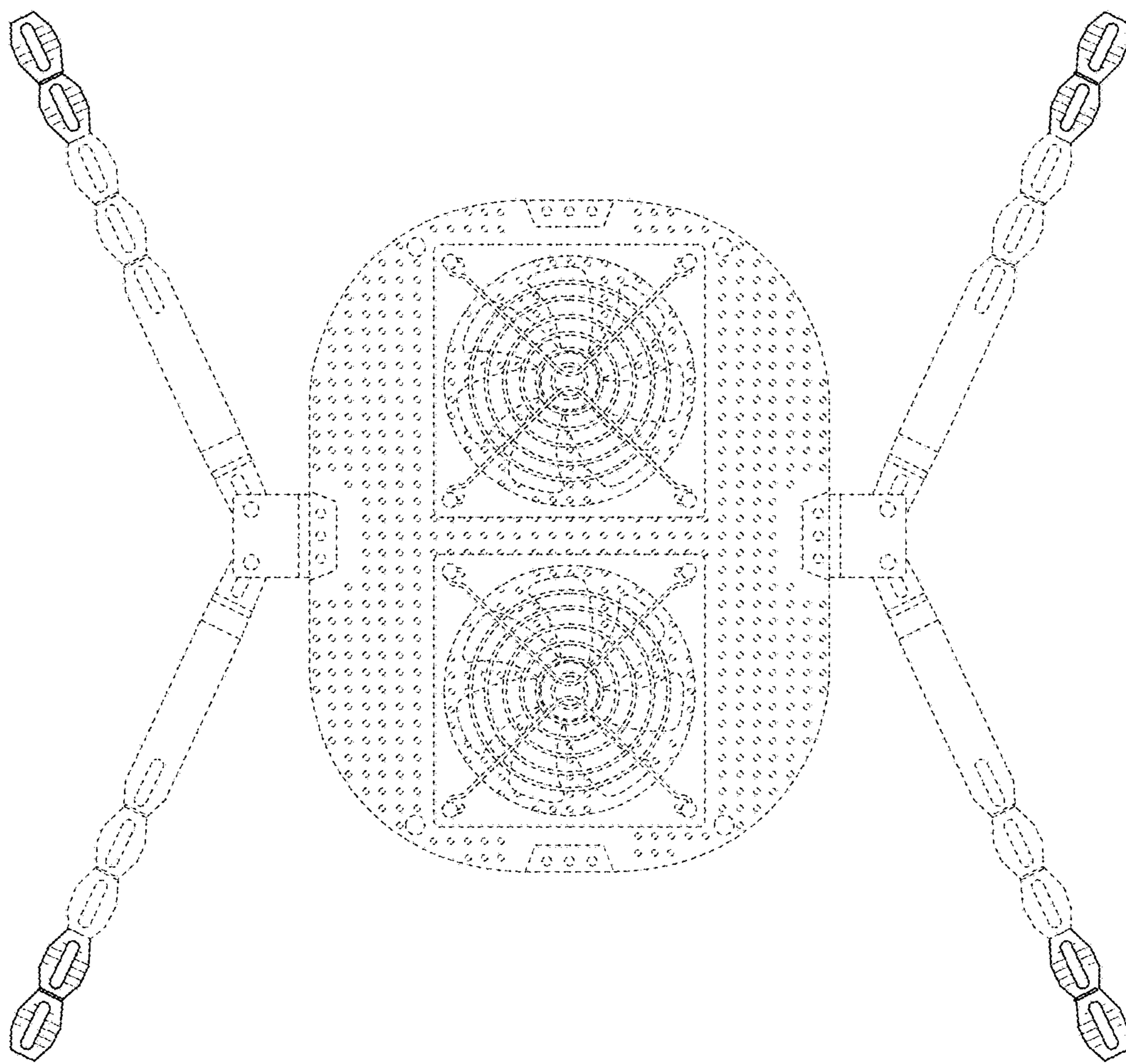

FIG. 17

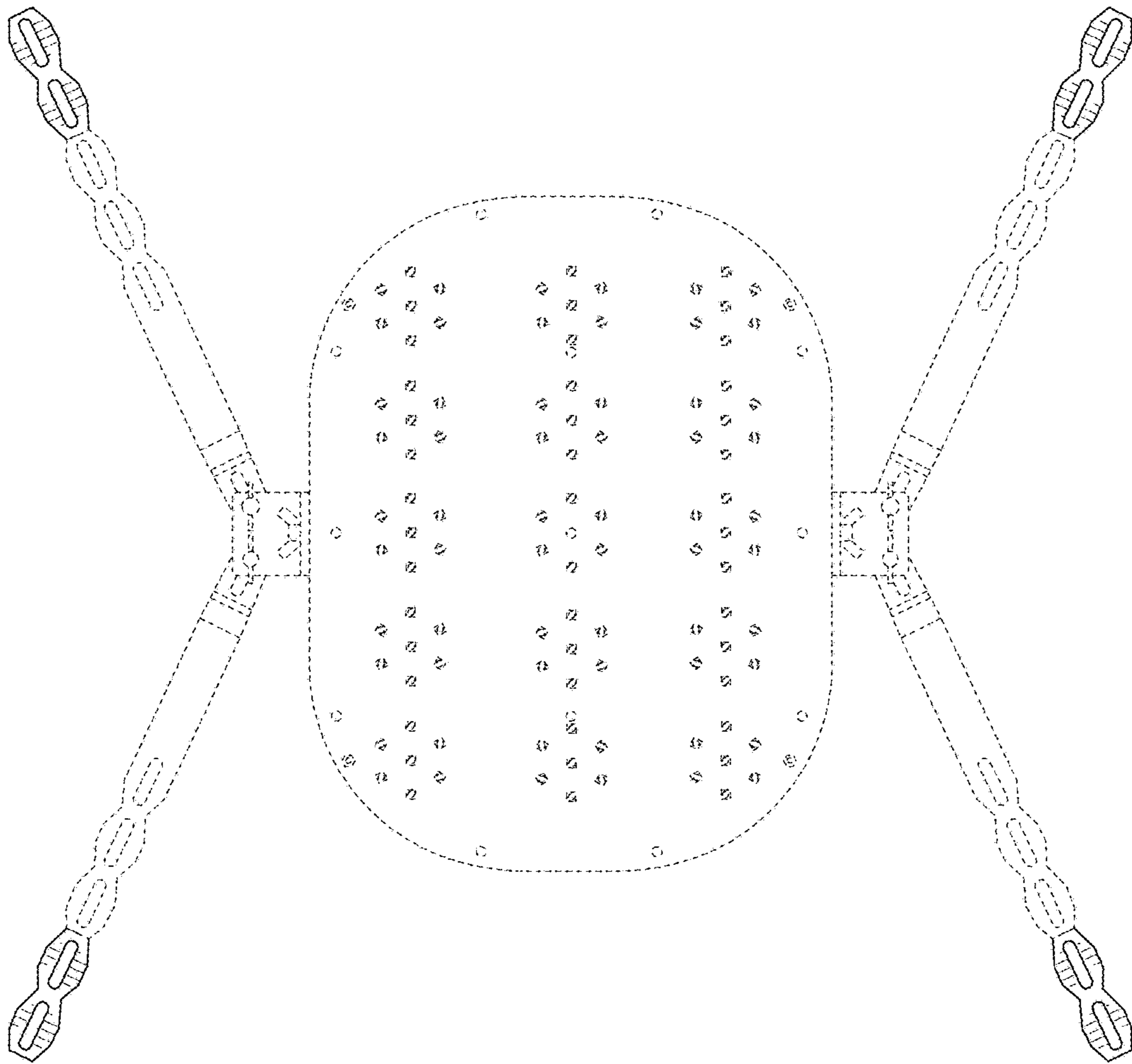
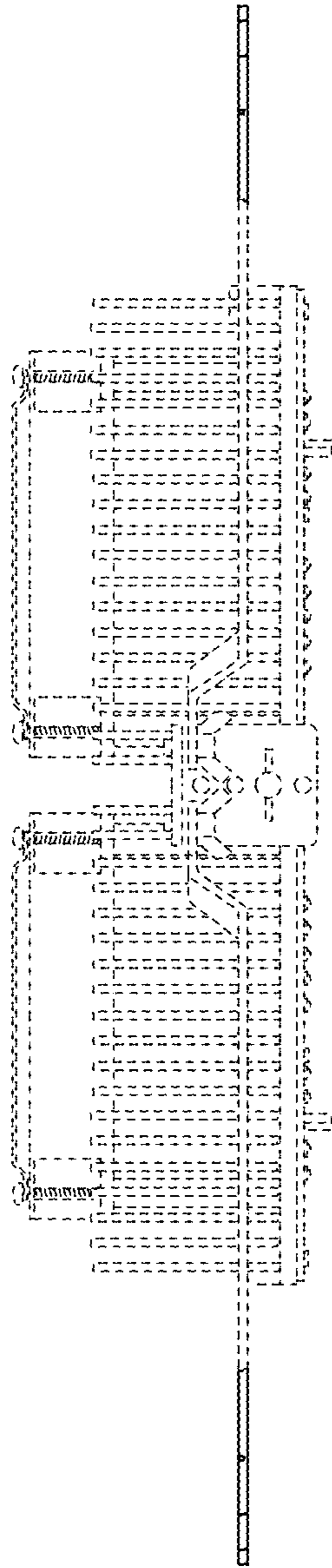

FIG. 18



**FIG. 19**

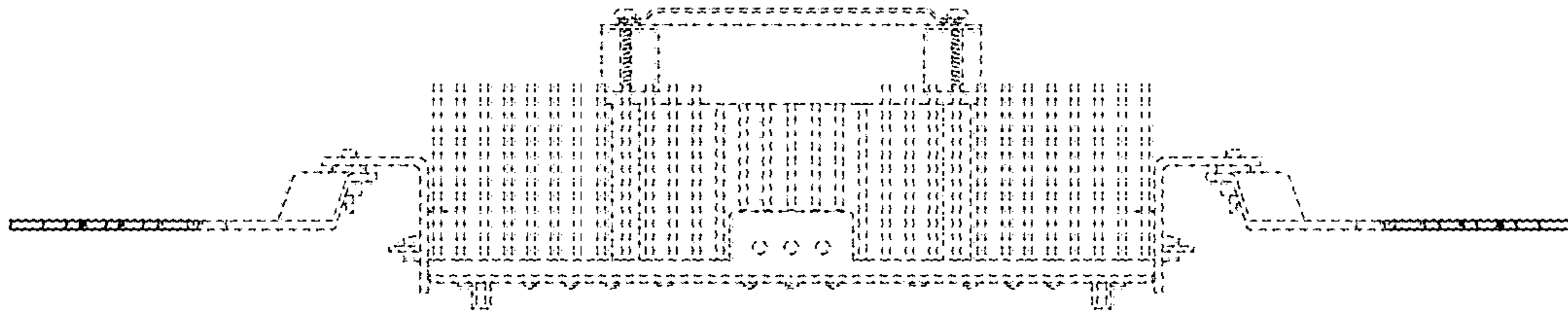

FIG. 20

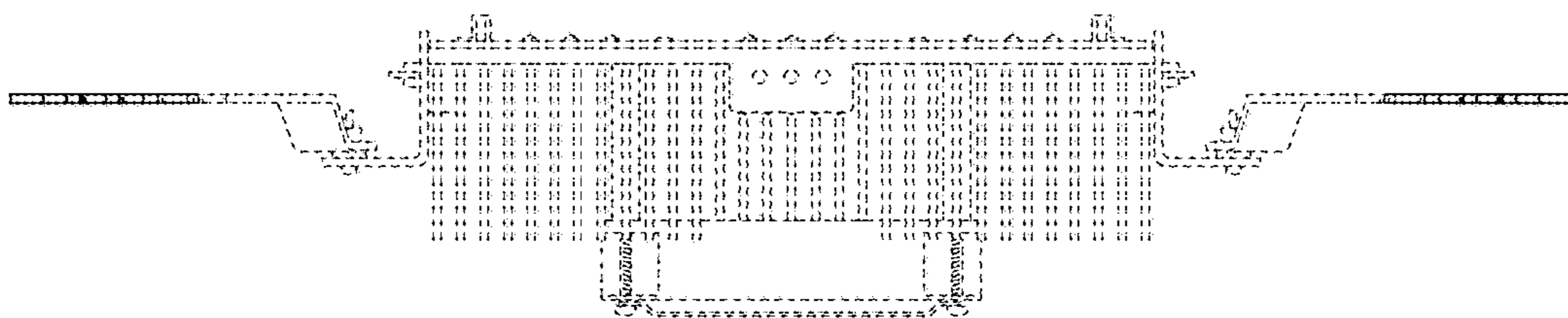

FIG. 21

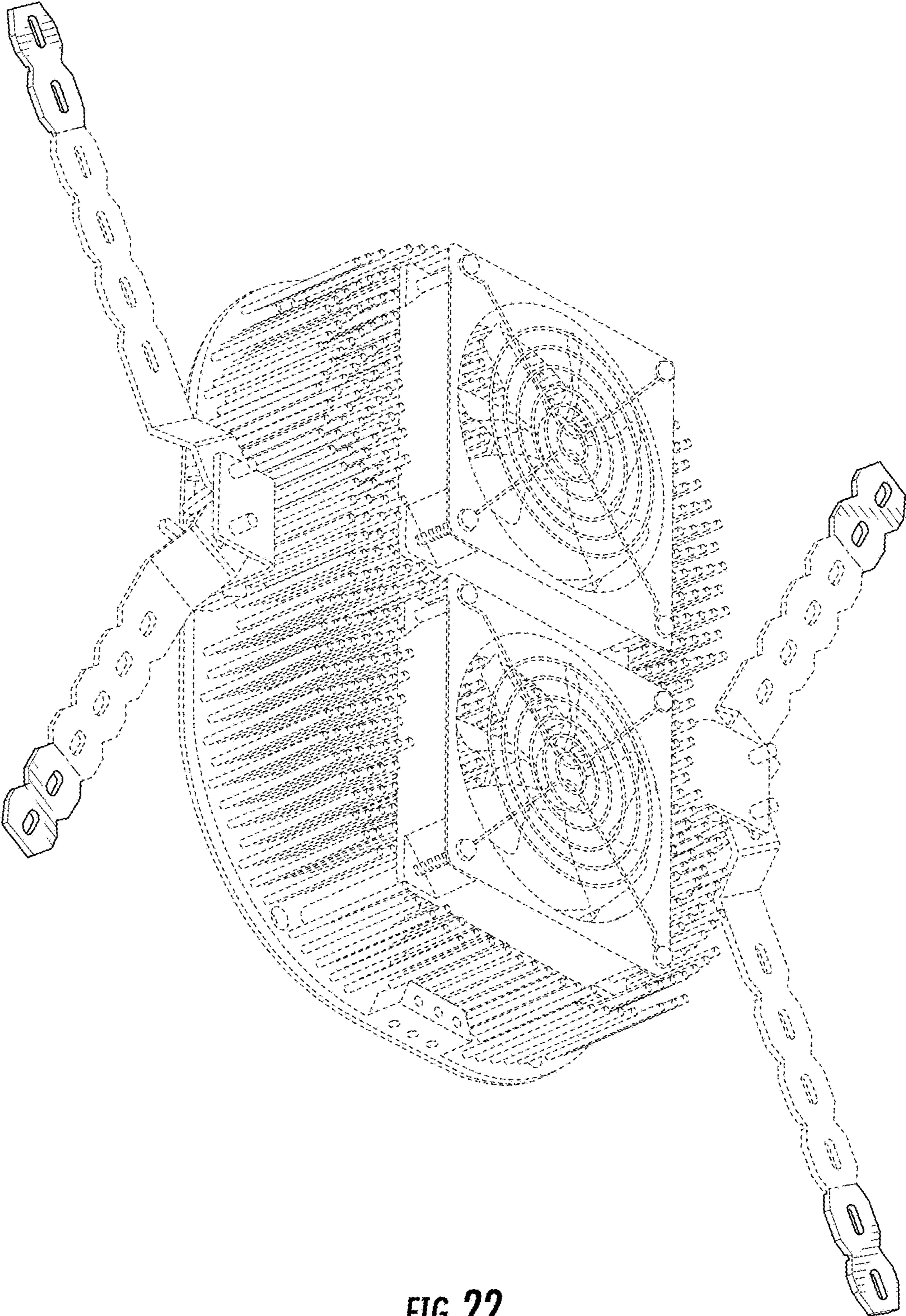

FIG. 22

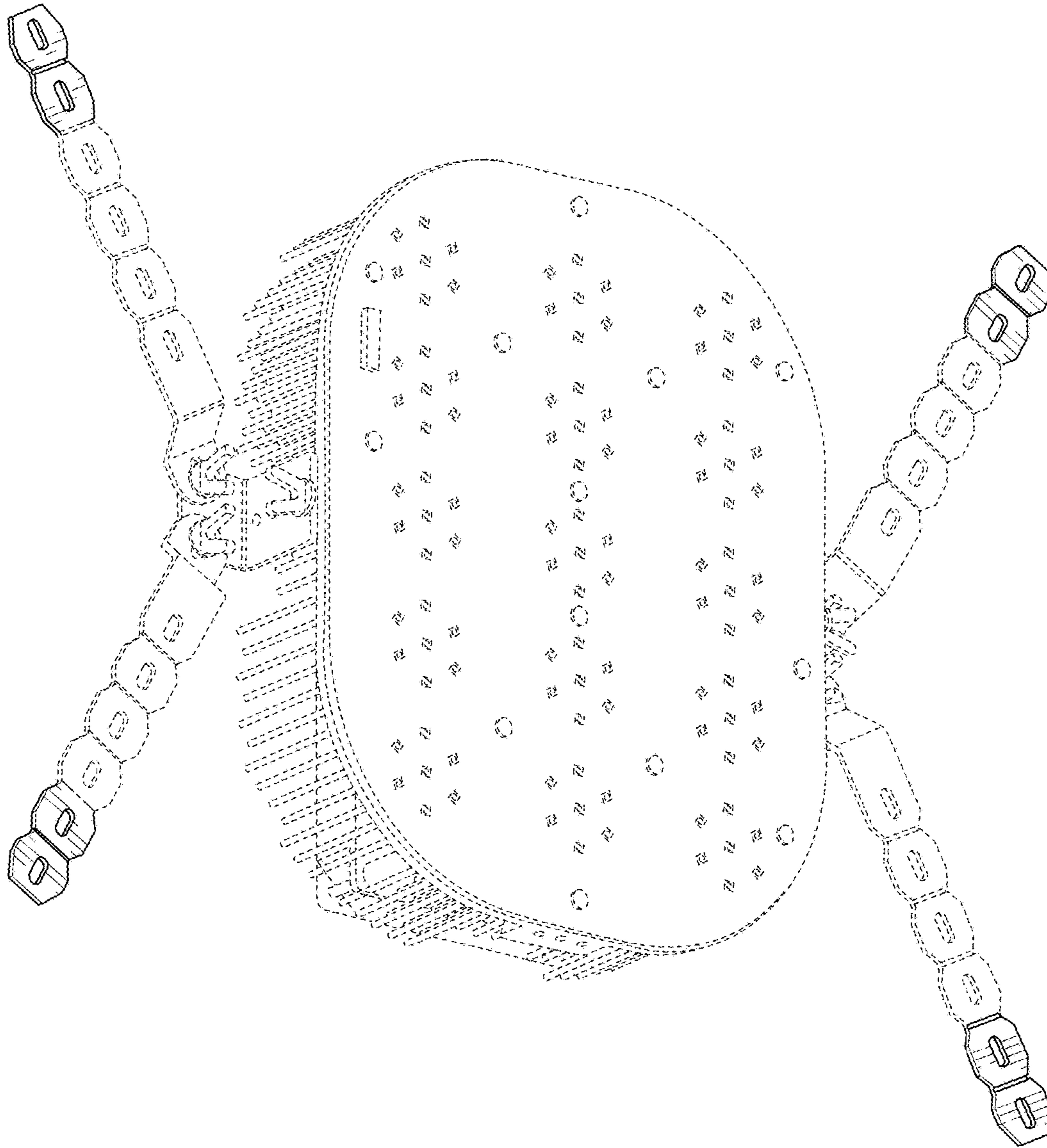

FIG. 23

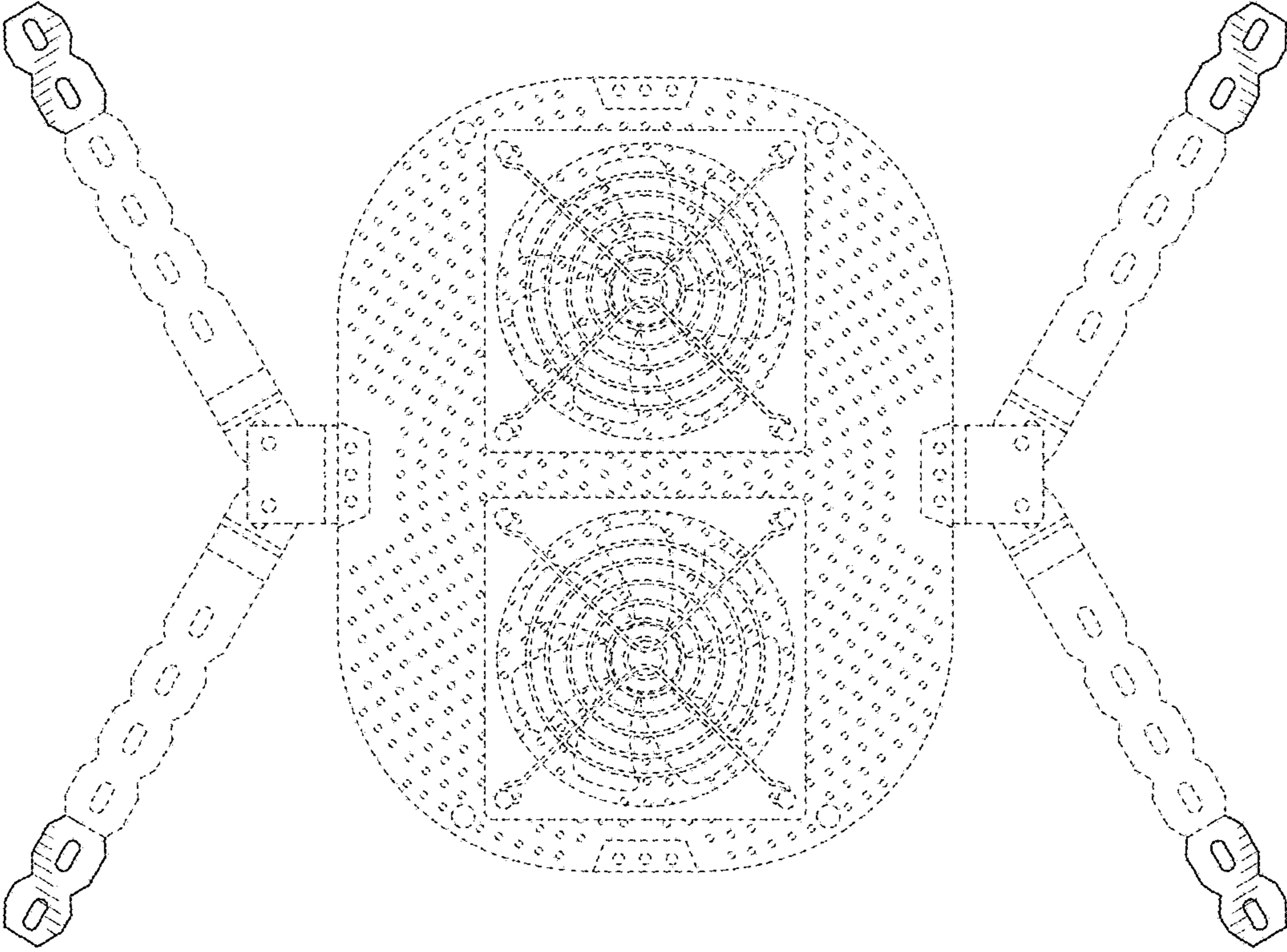

FIG. 24

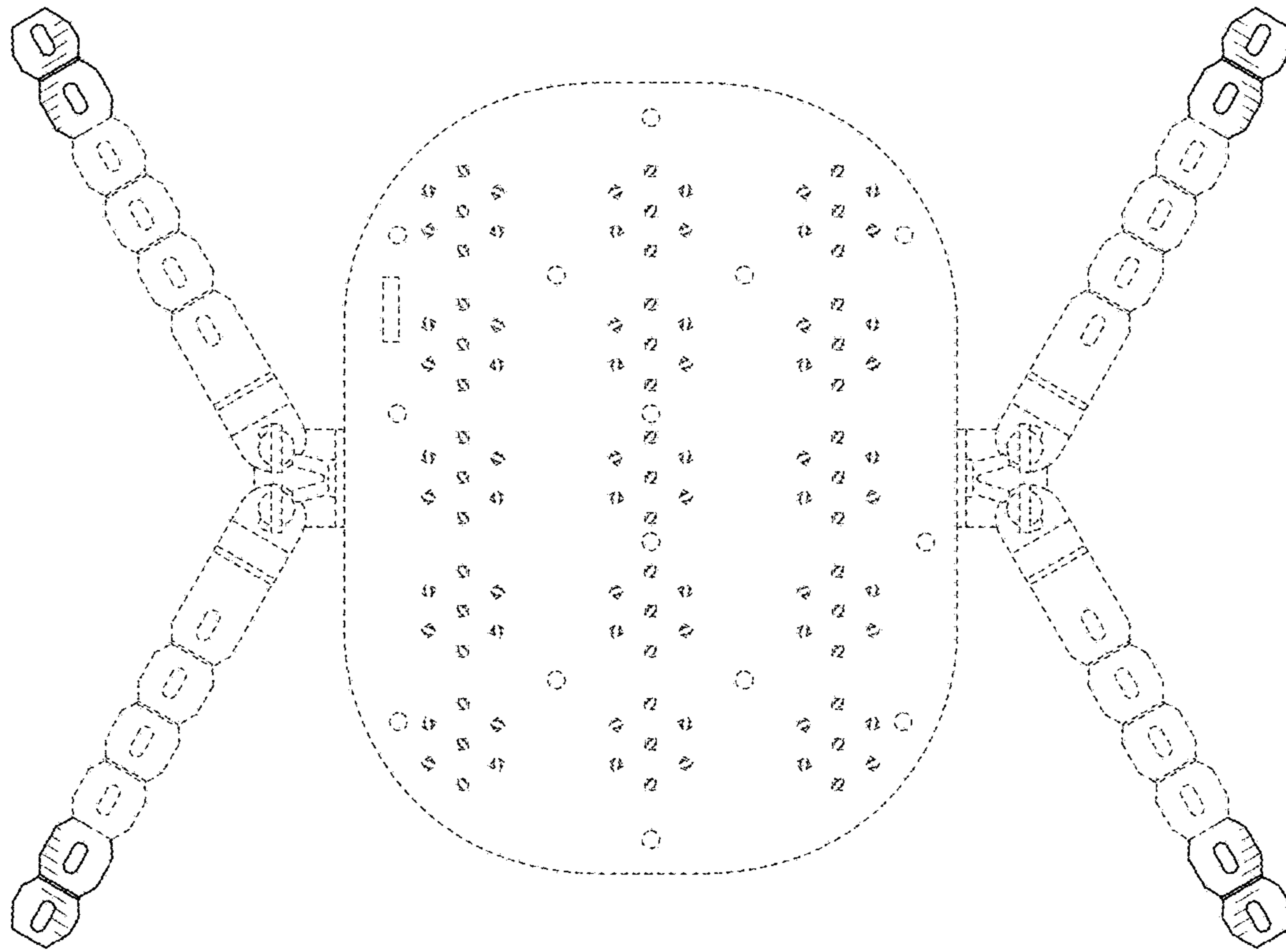

FIG. 25



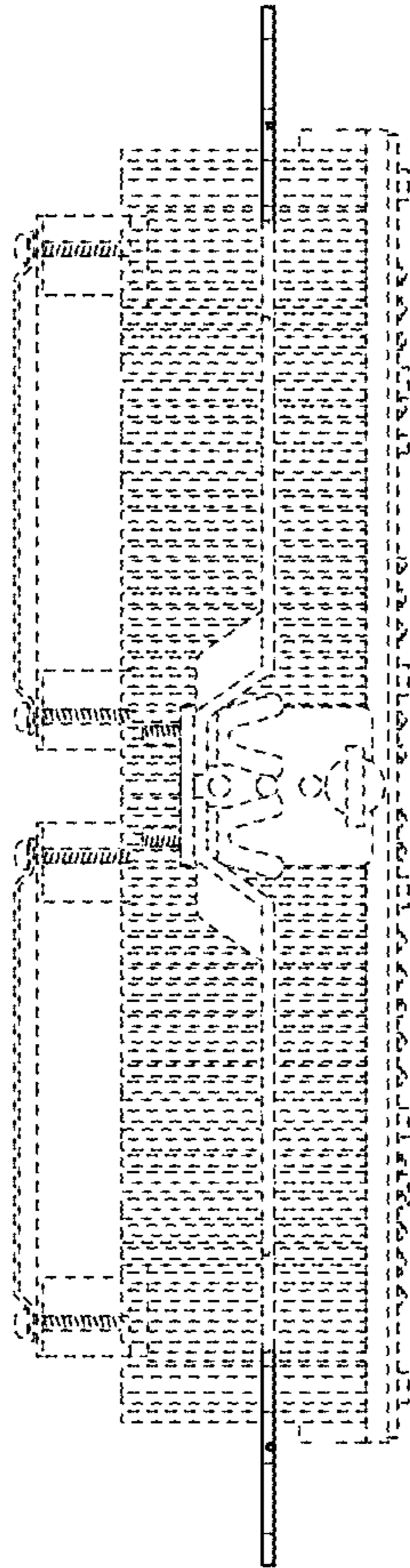

FIG. 26

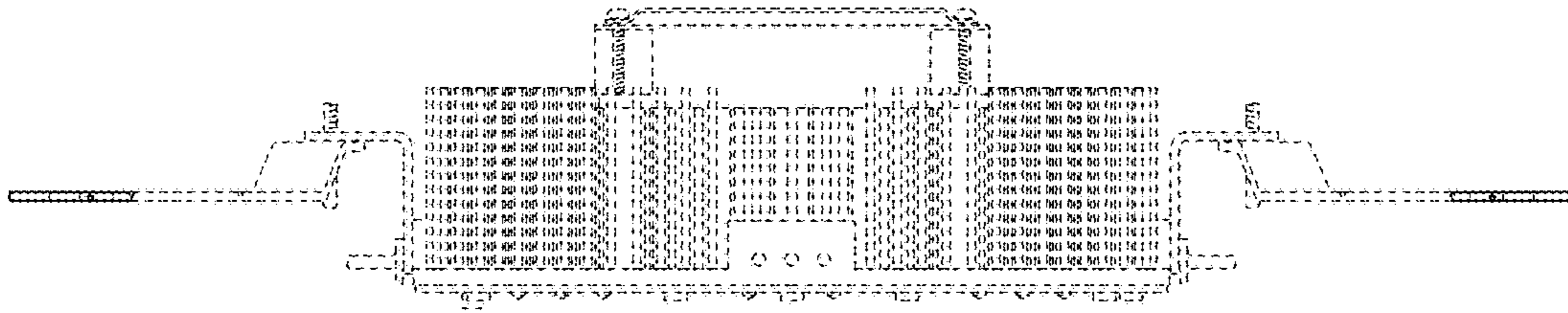

FIG. 27

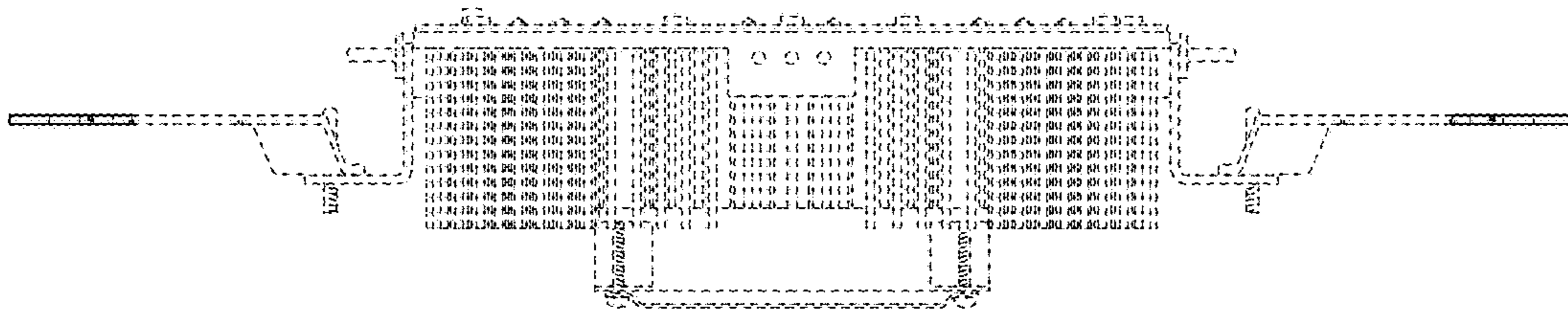

FIG. 28