



US00D803630S

(12) **United States Design Patent** (10) **Patent No.:** **US D803,630 S**
Dickens (45) **Date of Patent:** **** Nov. 28, 2017**

(54) **BEVERAGE CHILLER** 7,571,830 B2 * 8/2009 Lin A47J 41/0016
206/217
(71) Applicant: **Tequila Cuervo, S.A. de C.V.,** D627,603 S * 11/2010 Eyal D7/510
Tlaquepaque (Jalisco) (MX) D713,685 S * 9/2014 Eyal D7/507
9,314,126 B2 * 4/2016 Molayem A47G 19/2288
(72) Inventor: **Anthony Thomas Fitzpatrick Dickens,** 2010/0024660 A1 * 2/2010 Wallace B01F 3/04794
London (GB) 99/323.2

(73) Assignee: **TEQUILA CUERVO, S.A. DE C.V.,**
Tlaquepaque (Jalisco) C.P. (MX)

(**) Term: **15 Years**

(21) Appl. No.: **29/589,008**

(22) Filed: **Dec. 27, 2016**

(51) **LOC (10) Cl.** **07-01**

(52) **U.S. Cl.**
USPC **D7/603; D7/300.1**

(58) **Field of Classification Search**
USPC D7/603-608, 300.1, 598, 510, 511
CPC A47J 43/27; A47J 41/0016; F25D 3/06;
A47G 19/2288; B01F 3/04794
See application file for complete search history.

(56) **References Cited**

U.S. PATENT DOCUMENTS

D219,898 S * 2/1971 Buckley D7/300.1
D530,968 S * 10/2006 Bodum D7/300.1

* cited by examiner

Primary Examiner — Terry A Wallace

(74) *Attorney, Agent, or Firm* — Abelman, Frayne & Schwab

(57) **CLAIM**

The ornamental design for a beverage chiller, as shown and described.

DESCRIPTION

FIG. 1 is a front, top, and right perspective view of a beverage chiller showing the new design; FIG. 2 is a front elevation thereof; FIG. 3 is a rear elevation thereof; FIG. 4 is a right side elevation thereof, the left side elevation being a mirror image thereof; FIG. 5 is a top plan thereof; and, FIG. 6 is a bottom plan thereof.

1 Claim, 5 Drawing Sheets

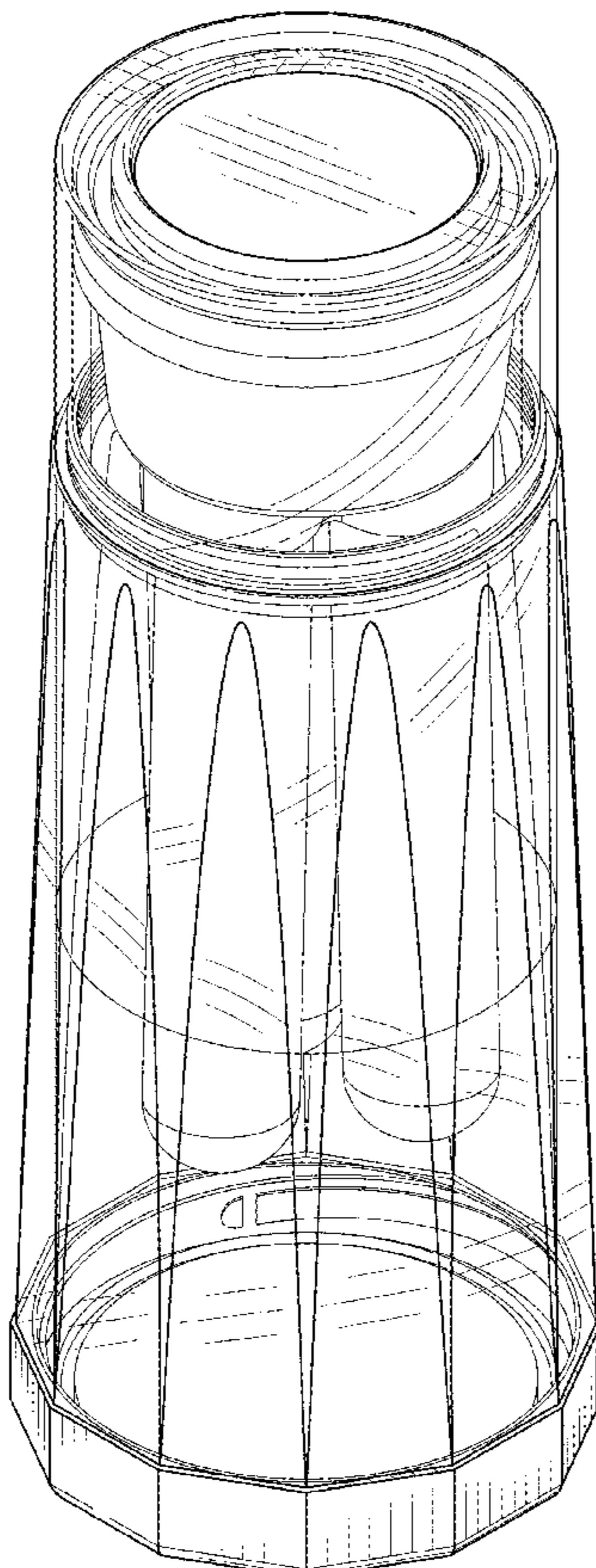

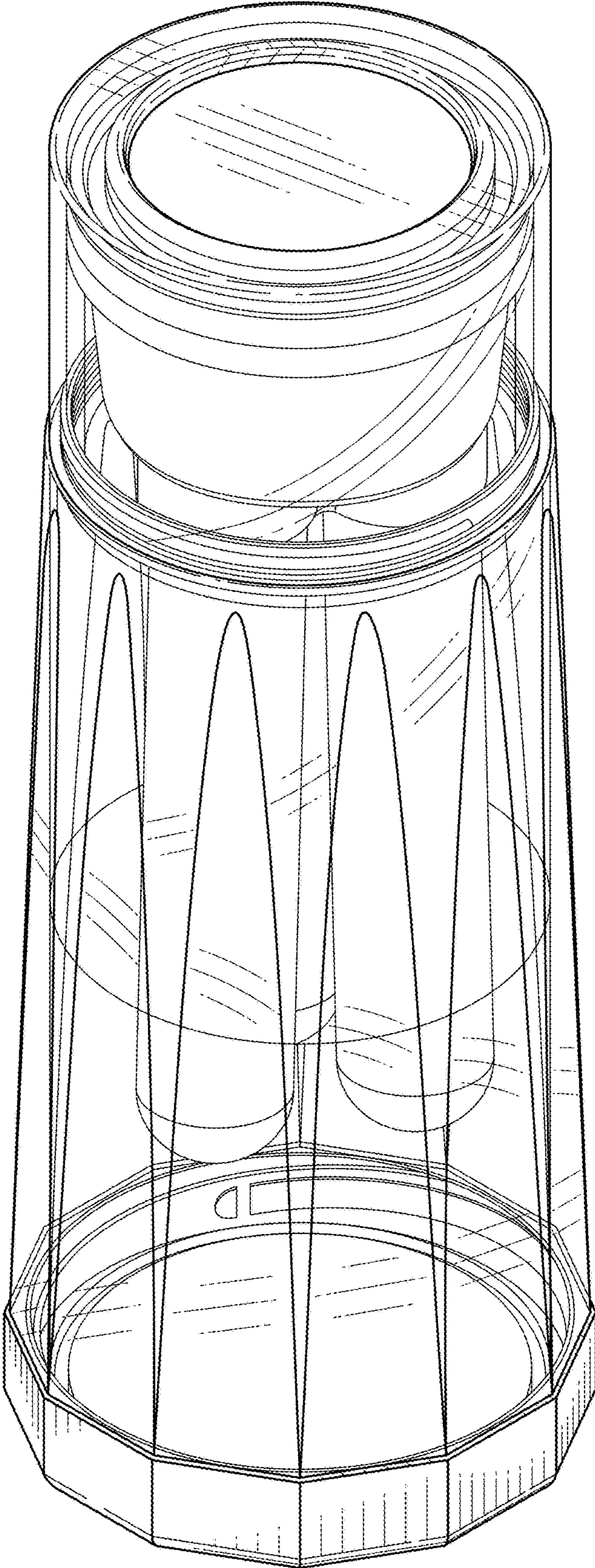

FIG. 1

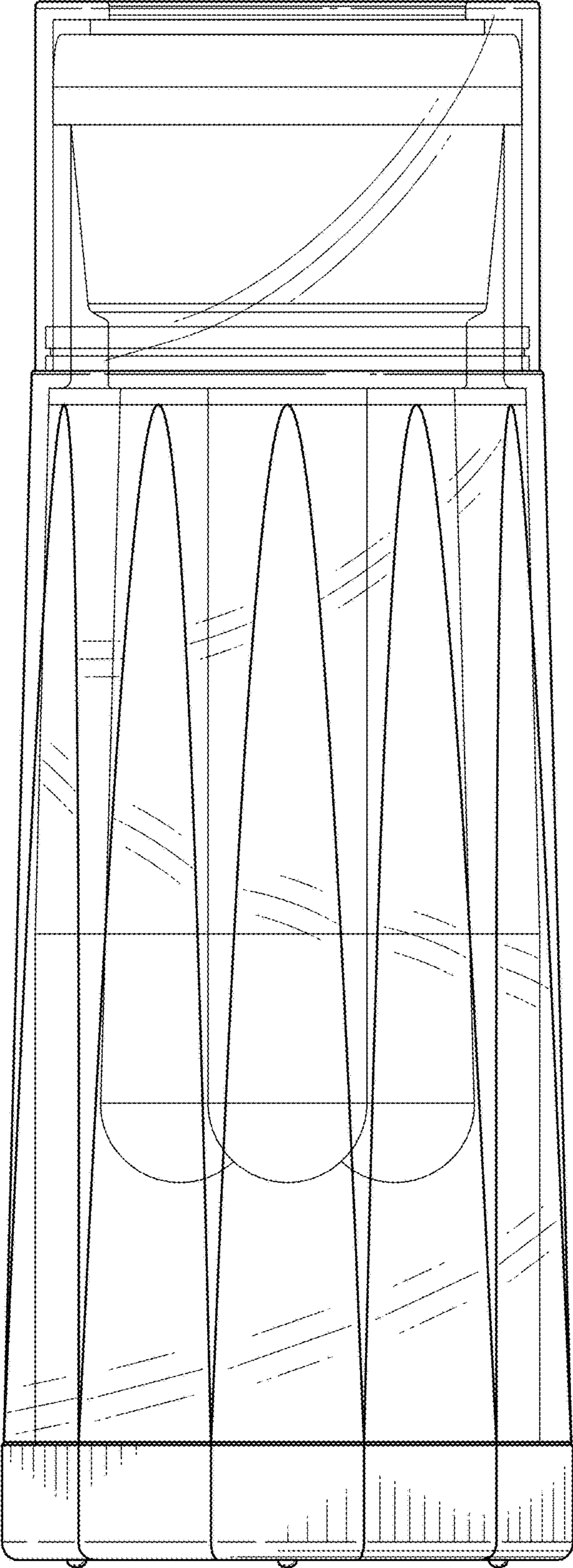

FIG. 2

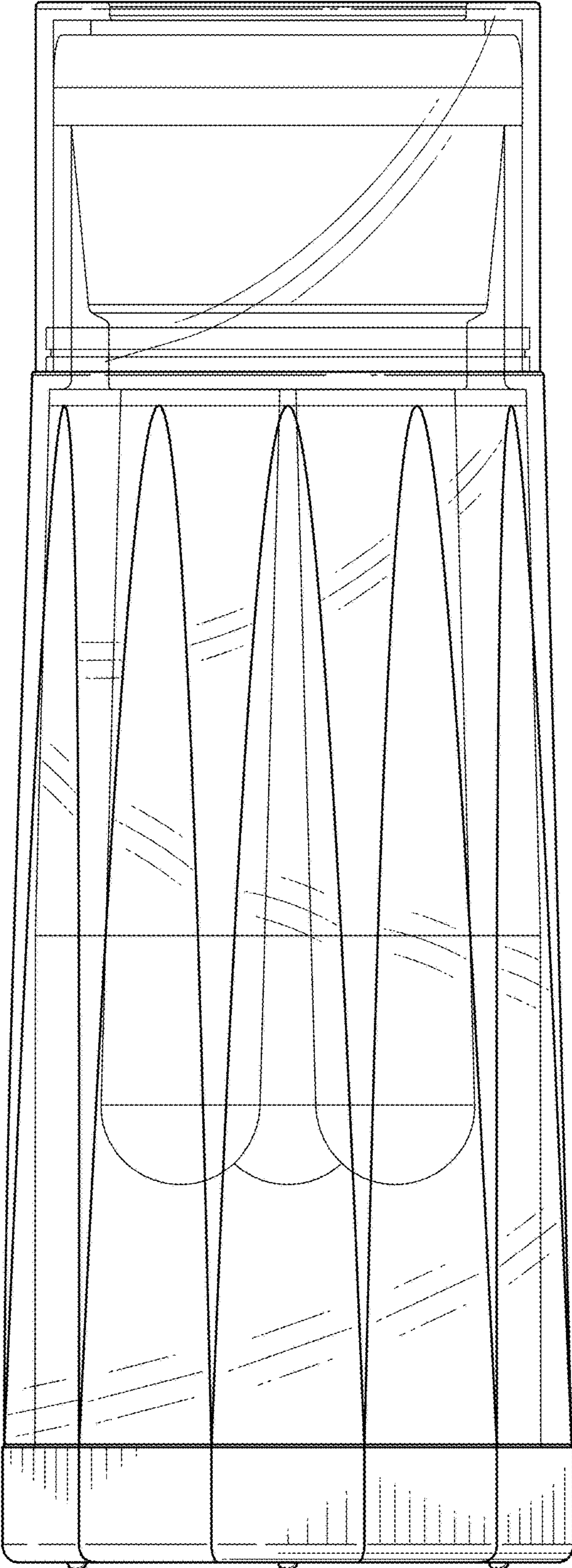

FIG. 3

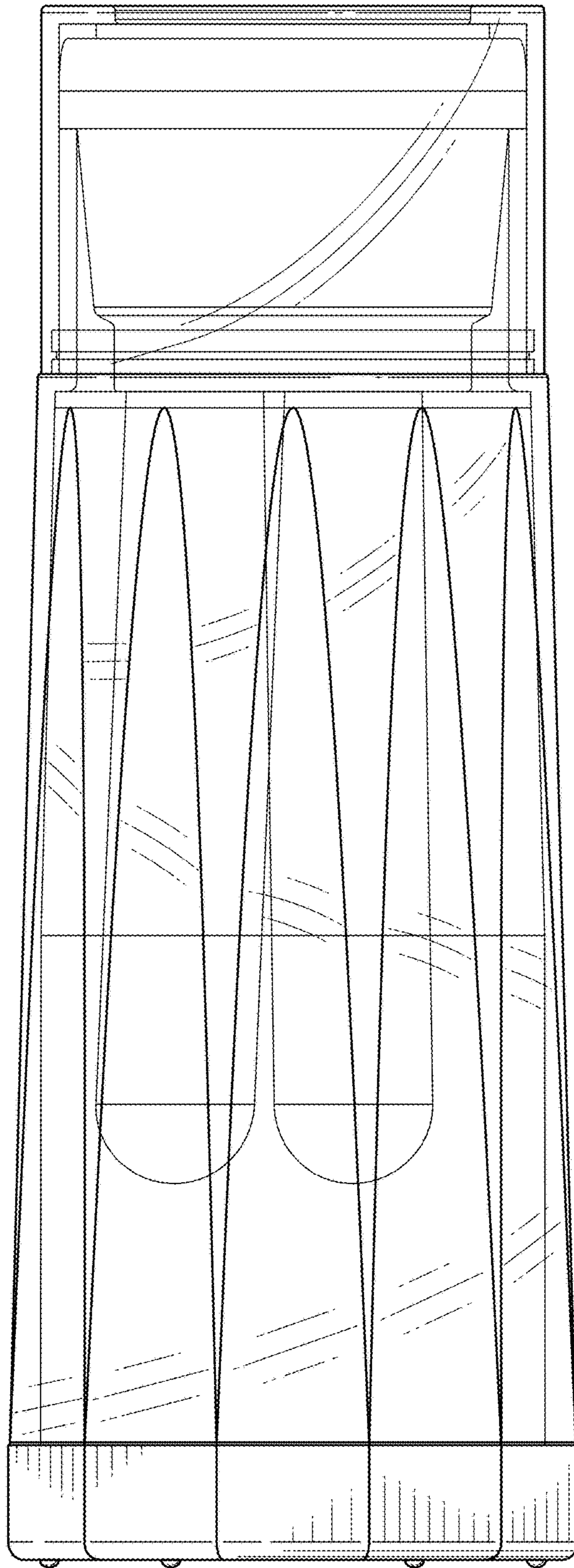

FIG. 4

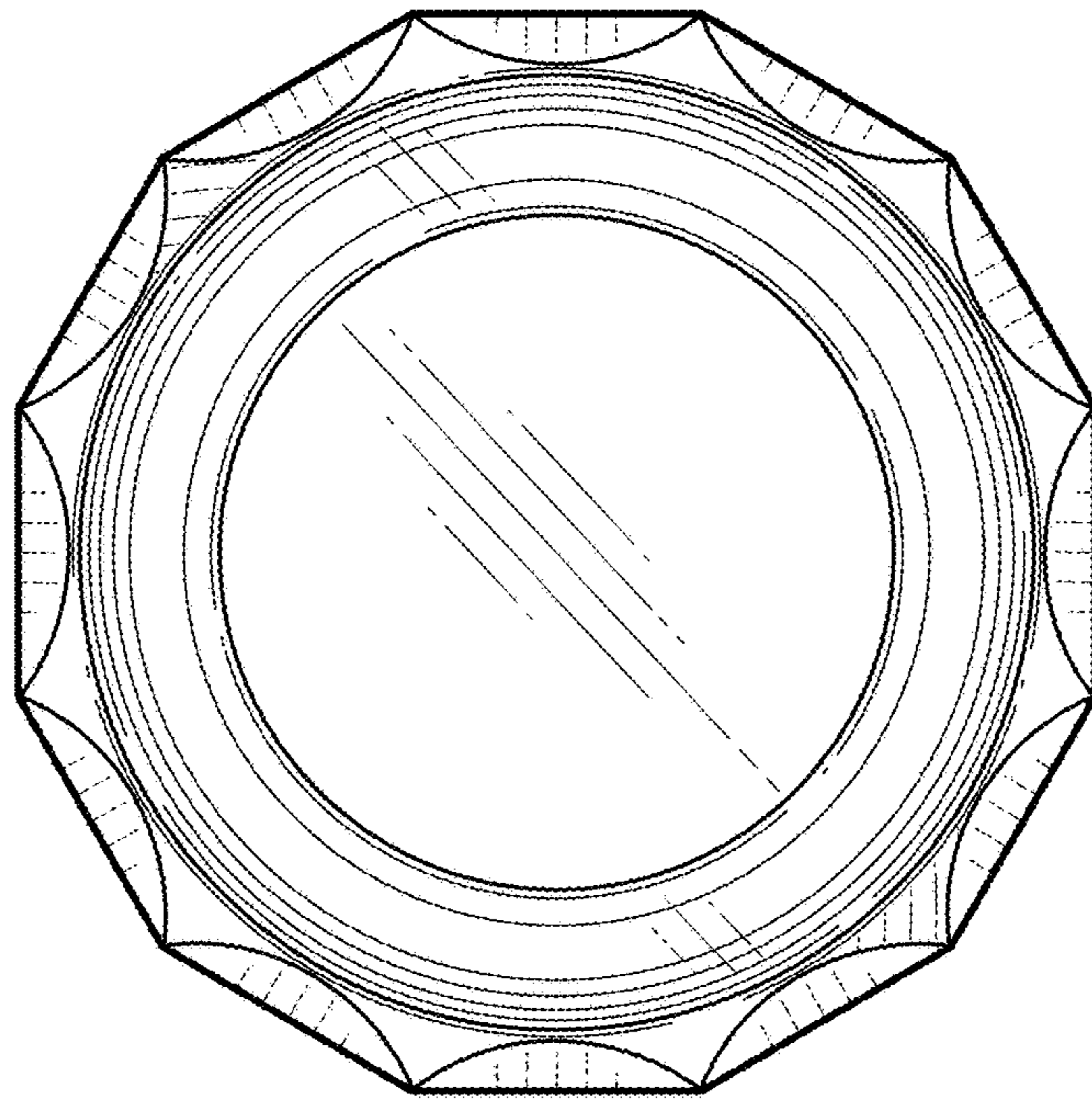

FIG. 5

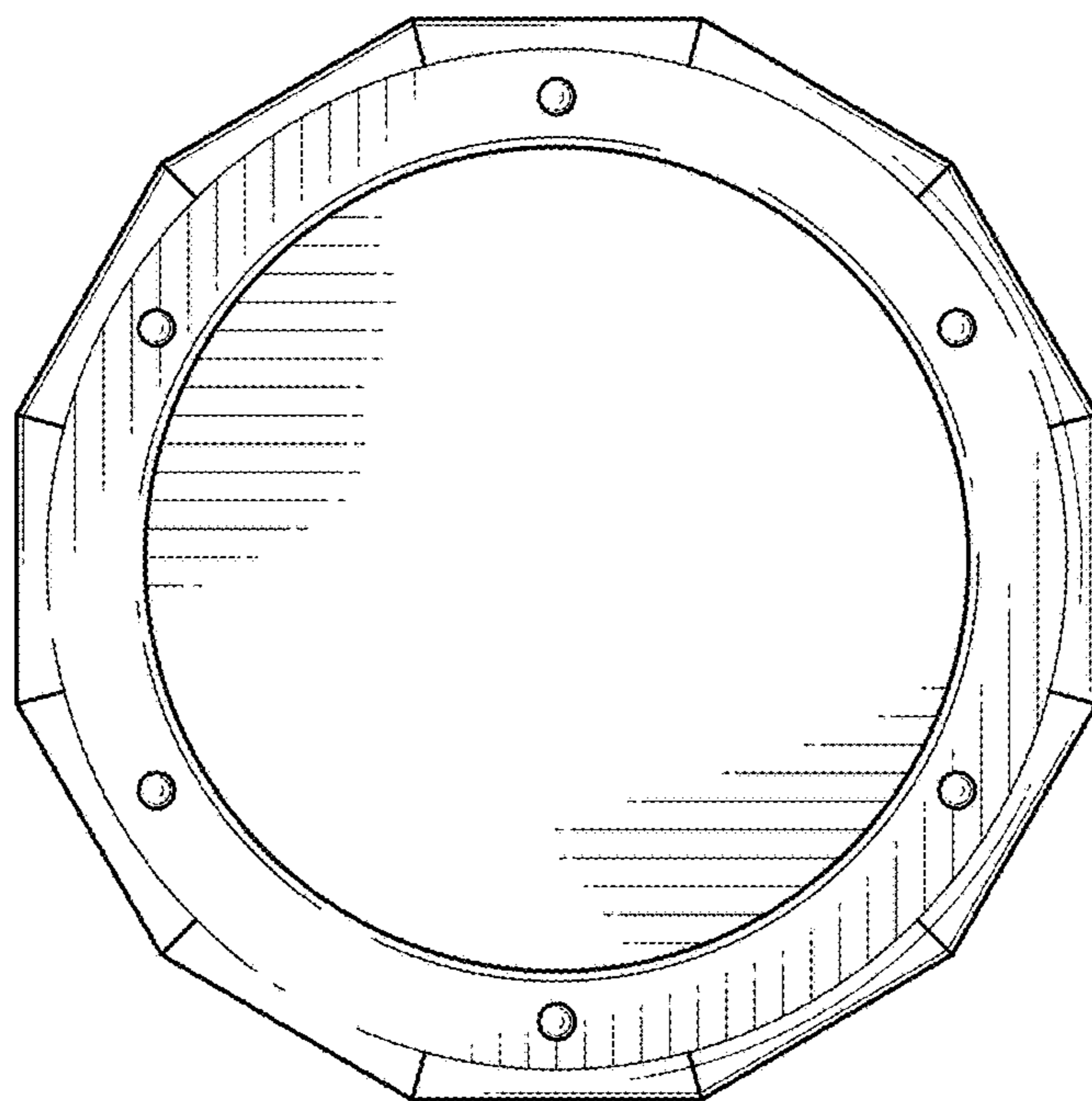

FIG. 6