



US00D803574S

(12) **United States Design Patent** (10) **Patent No.:** **US D803,574 S**
Munitz et al. (45) **Date of Patent:** **** Nov. 28, 2017**

(54) **HAIRBRUSH**

4,287,898 A 9/1981 Konesky
4,325,392 A 4/1982 Iten et al.
4,417,595 A 11/1983 Okumura et al.

(71) Applicant: **Kampalook Ltd.**, Tel Aviv (IL)

(Continued)

(72) Inventors: **Lior Munitz**, Haifa (IL); **Meytal Baron**, Tel Aviv (IL); **Eitan Shiloh**, Tel Aviv (IL)

Primary Examiner — Susan Moon Lee

(74) *Attorney, Agent, or Firm* — Marc Van Dyke; Fourth Dimension IP

(73) Assignee: **Kampalook LTD.**, Tel Aviv (IL)

(57) **CLAIM**

The ornamental design for a hairbrush, as shown and described.

(**) Term: **14 Years**

(21) Appl. No.: **29/521,112**

DESCRIPTION

(22) Filed: **Mar. 19, 2015**

(51) **LOC (10) Cl.** **04-02**

(52) **U.S. Cl.**

USPC **D4/132**; D4/130; D4/136

(58) **Field of Classification Search**

USPC D4/132–136, 138; D7/393, 395, 401.2; D8/107, 303; D28/10, 28, 30, 35, 37; 15/143.1, 159.1, 160, 186–188, DIG. 5, 15/191.1, 192, 193, 201, 207.2; 16/430; 132/119.1, 120, 142, 313, 161, 121, 271, 132/219; D30/158, 159; 119/600, 612, 119/615, 625

CPC A46B 1/00; A46B 3/00; A46B 3/20; A46B 3/22; A46B 5/00; A46B 5/02; A46B 5/021; A46B 5/023; A46B 5/025; A46B 5/026; A46B 9/00; A46B 9/005; A46B 9/02; A46B 9/023; A46B 9/025; A46B 9/026; A46B 2200/00; A46B 2200/10; A46B 2200/102; A46B 2200/104; A46B 2200/1093; A46D 1/00; Y10S 15/05

See application file for complete search history.

FIG. 1 is a front view of a first embodiment of a hairbrush showing the new design;

FIG. 2 is a back view thereof;

FIG. 3 is a right view thereof;

FIG. 4 is a left view thereof;

FIG. 5 is a top view thereof;

FIG. 6 is a bottom view thereof;

FIG. 7 is a perspective view thereof;

FIG. 8 is a front view of a second embodiment of the new design;

FIG. 9 is a back view thereof;

FIG. 10 is a right view thereof;

FIG. 11 is a left view thereof;

FIG. 12 is a top view thereof;

FIG. 13 is a bottom view thereof; and,

FIG. 14 is a perspective view thereof.

The broken lines immediately adjacent to the shaded areas, represent the bounds of the claimed design while all other broken lines are directed to environment and are for illustrative purposes only; the broken lines form no part of the claimed design.

The portions between the pairs of closely adjacent, spaced jagged dash-dot-dot broken lines in the drawings are broken away to indicate no particular length or width, and such pairs of jagged, broken lines themselves form no part of the claimed design. The materials that may be visible between the jagged lines have been removed for clarity.

(56) **References Cited**

U.S. PATENT DOCUMENTS

3,949,765 A 4/1976 Vallis
4,121,314 A 10/1978 Nathe
4,161,050 A 7/1979 Sasaki et al.

1 Claim, 10 Drawing Sheets

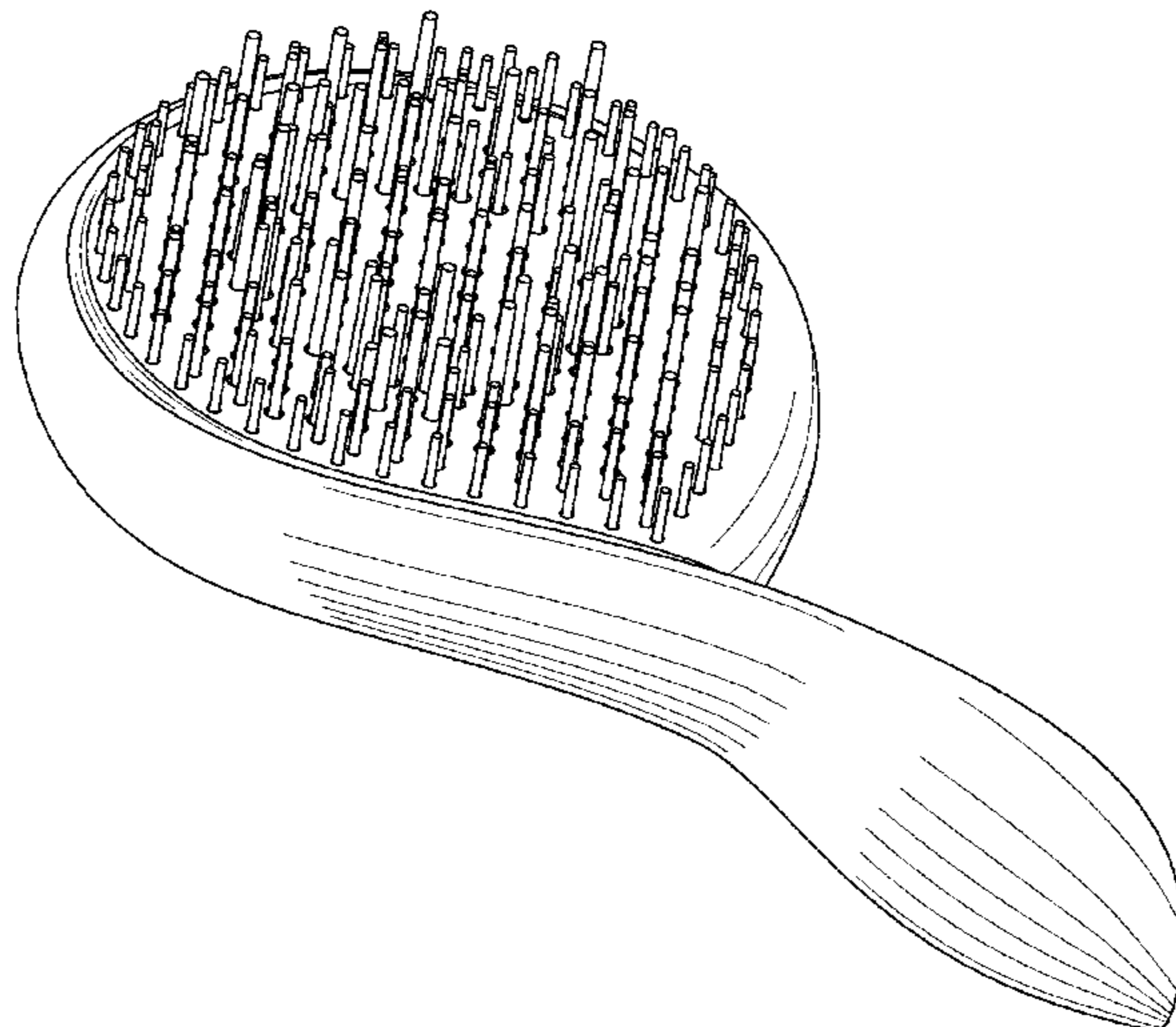

(56)

References Cited

U.S. PATENT DOCUMENTS

4,475,563	A	10/1984	Martin	
4,500,939	A	2/1985	Gueret	
4,694,525	A	9/1987	Yamamoto et al.	
5,638,608	A	6/1997	Dorber	
5,755,242	A	5/1998	Denebeim	
6,226,811	B1	5/2001	Fagan	
6,308,717	B1	10/2001	Vrtaric	
6,497,719	B2*	12/2002	Pearl	A61N 5/0617 607/88
7,156,105	B2	1/2007	Gueret	
8,181,304	B1	5/2012	Kamath	
8,627,537	B2	1/2014	Mercier	
2002/0004964	A1	1/2002	Luchino et al.	
2002/0011251	A1	1/2002	Gueret	
2003/0009838	A1	1/2003	Nakamura	
2004/0003478	A1	1/2004	Mink	
2004/0221863	A1	11/2004	Chen	
2004/0237233	A1	12/2004	Dragan et al.	
2005/0055788	A1	3/2005	Chang et al.	
2005/0210614	A1	9/2005	Chang	
2009/0083925	A1	4/2009	Mathiez	
2010/0101594	A1	4/2010	Pulfrey	
2010/0269841	A1	10/2010	Honnefeller et al.	

* cited by examiner

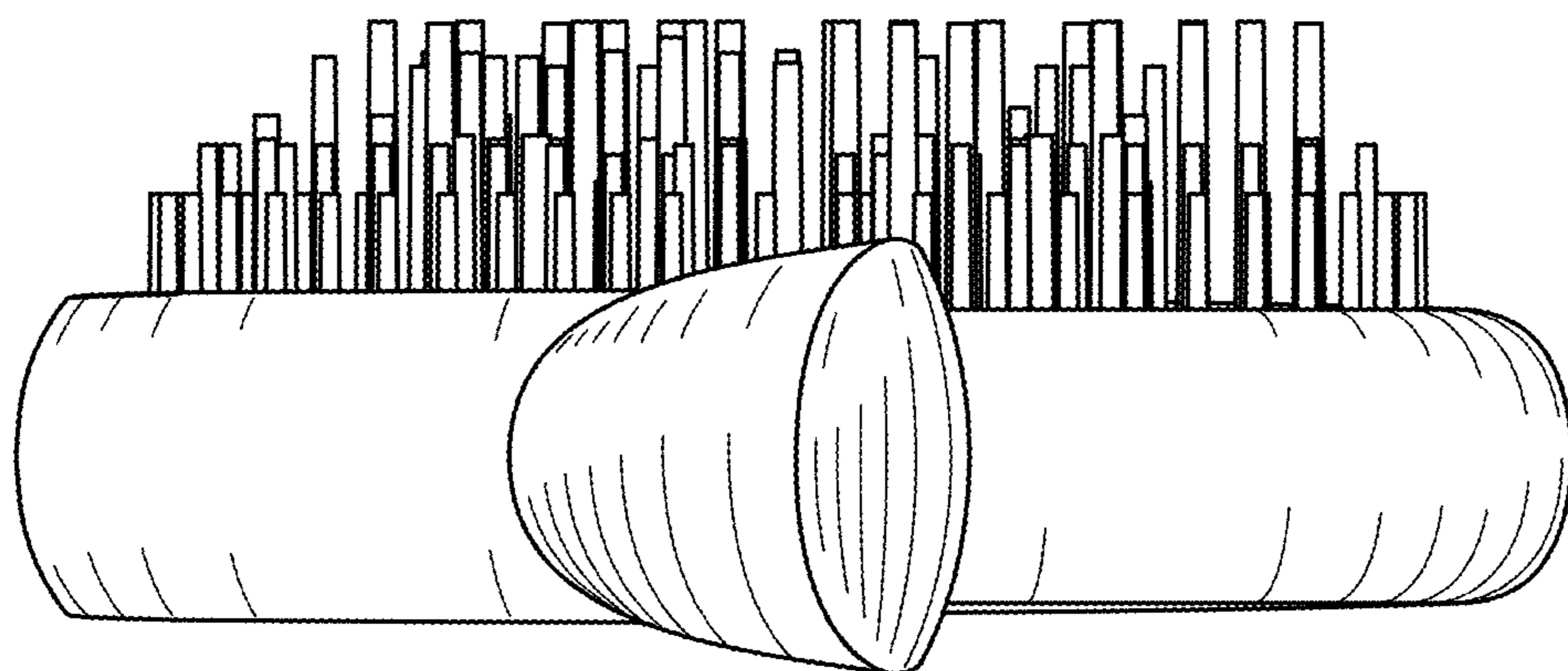

Fig. 1

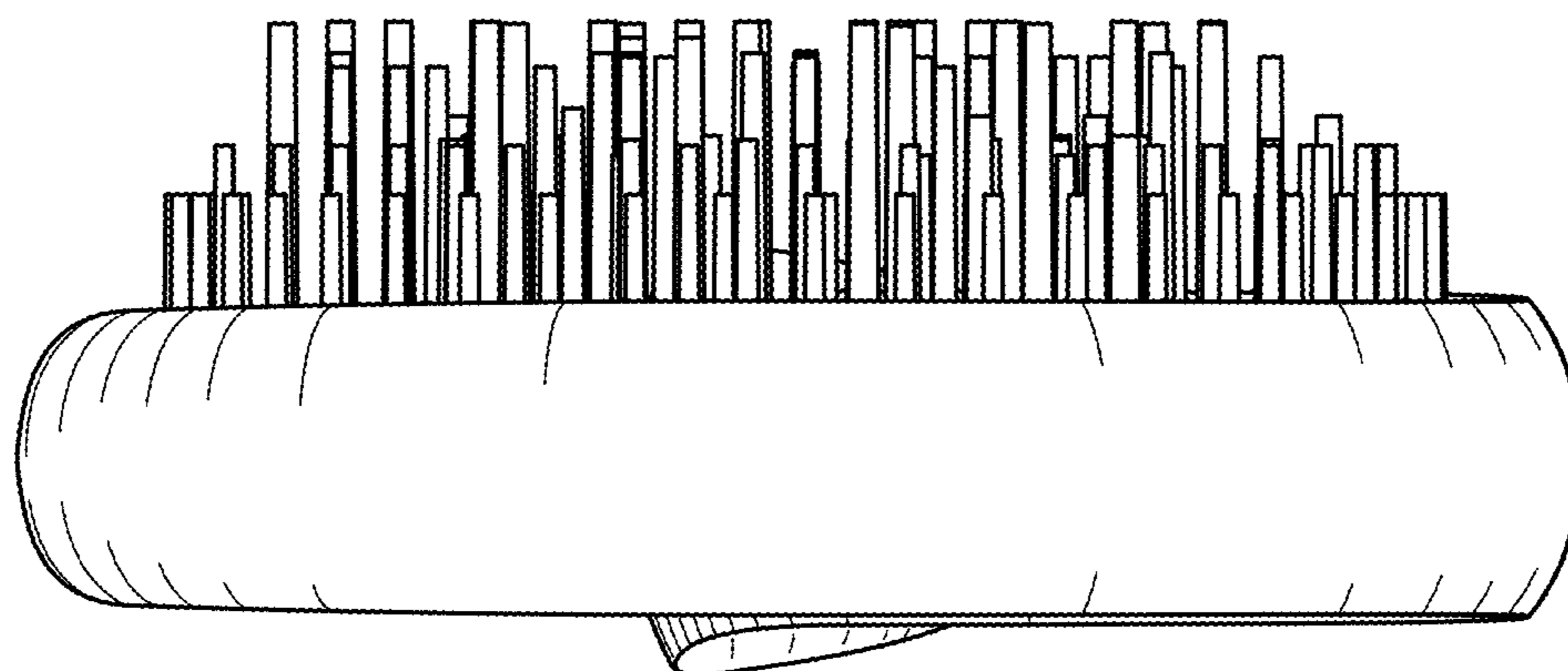

Fig. 2

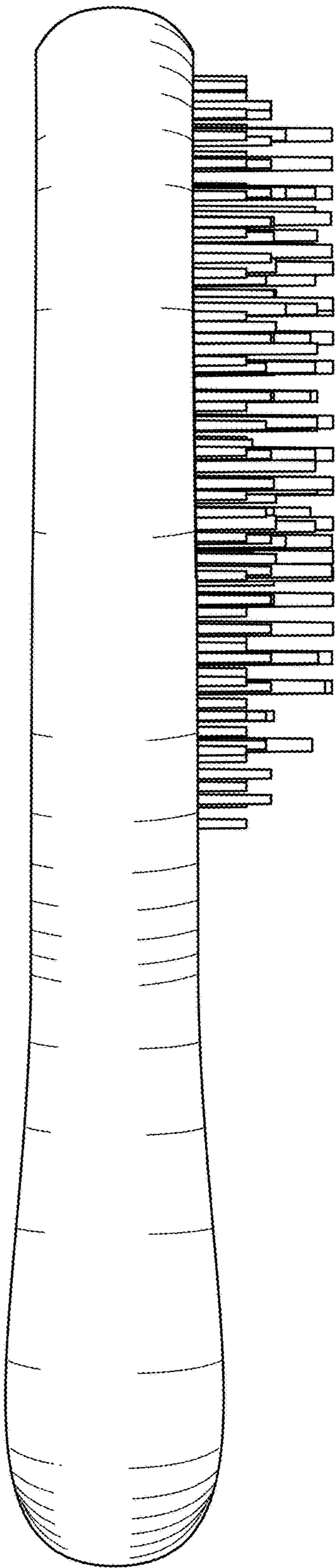

Fig. 3

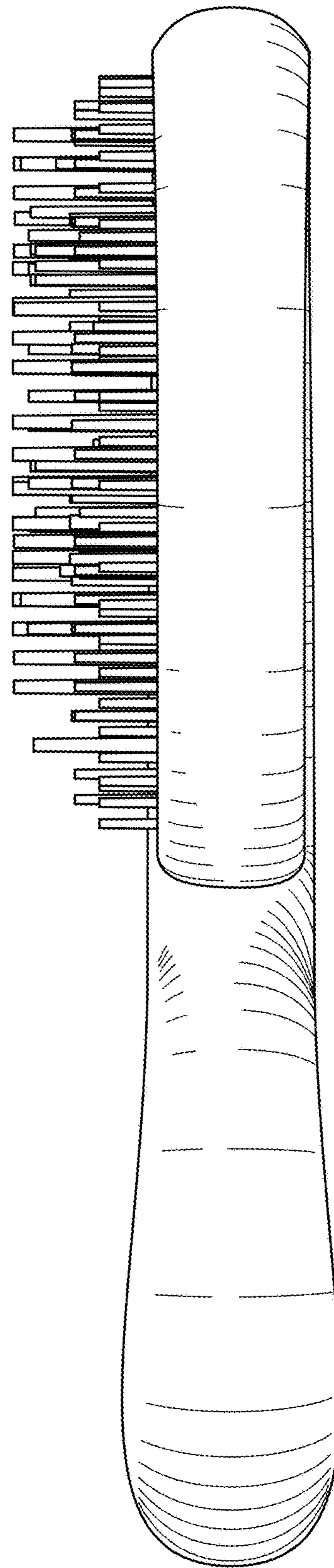

Fig. 4

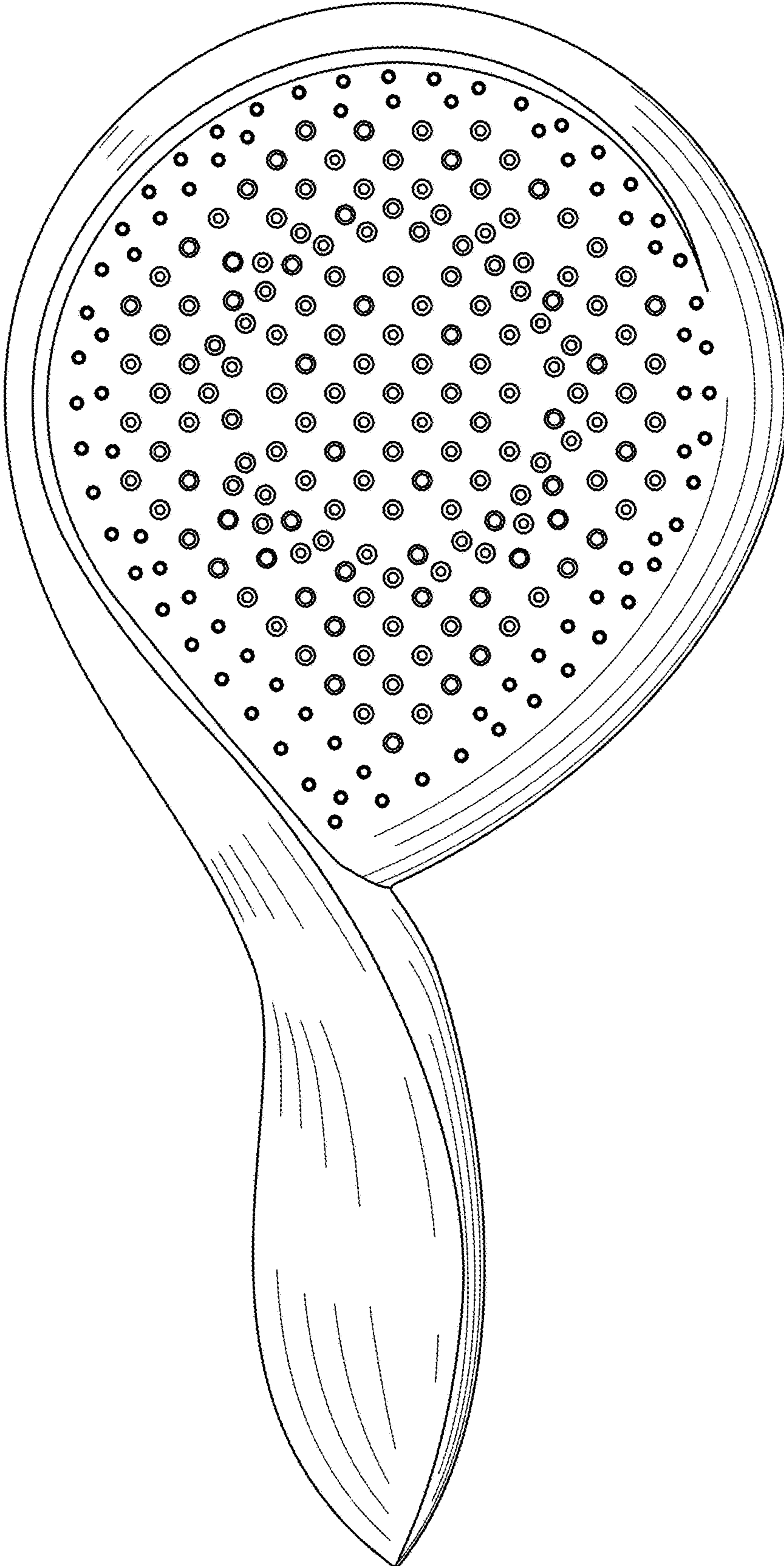

Fig. 5

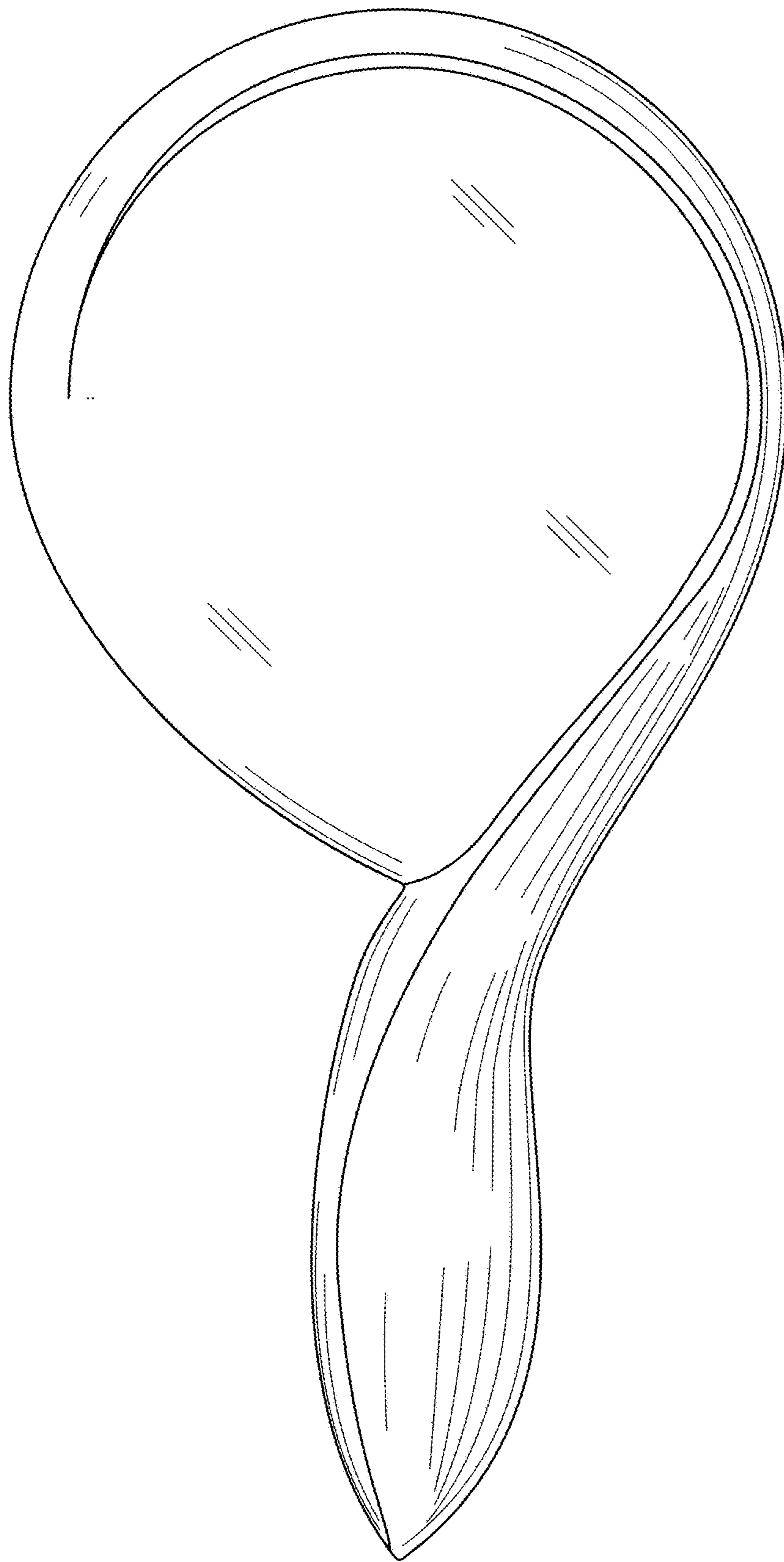

Fig. 6

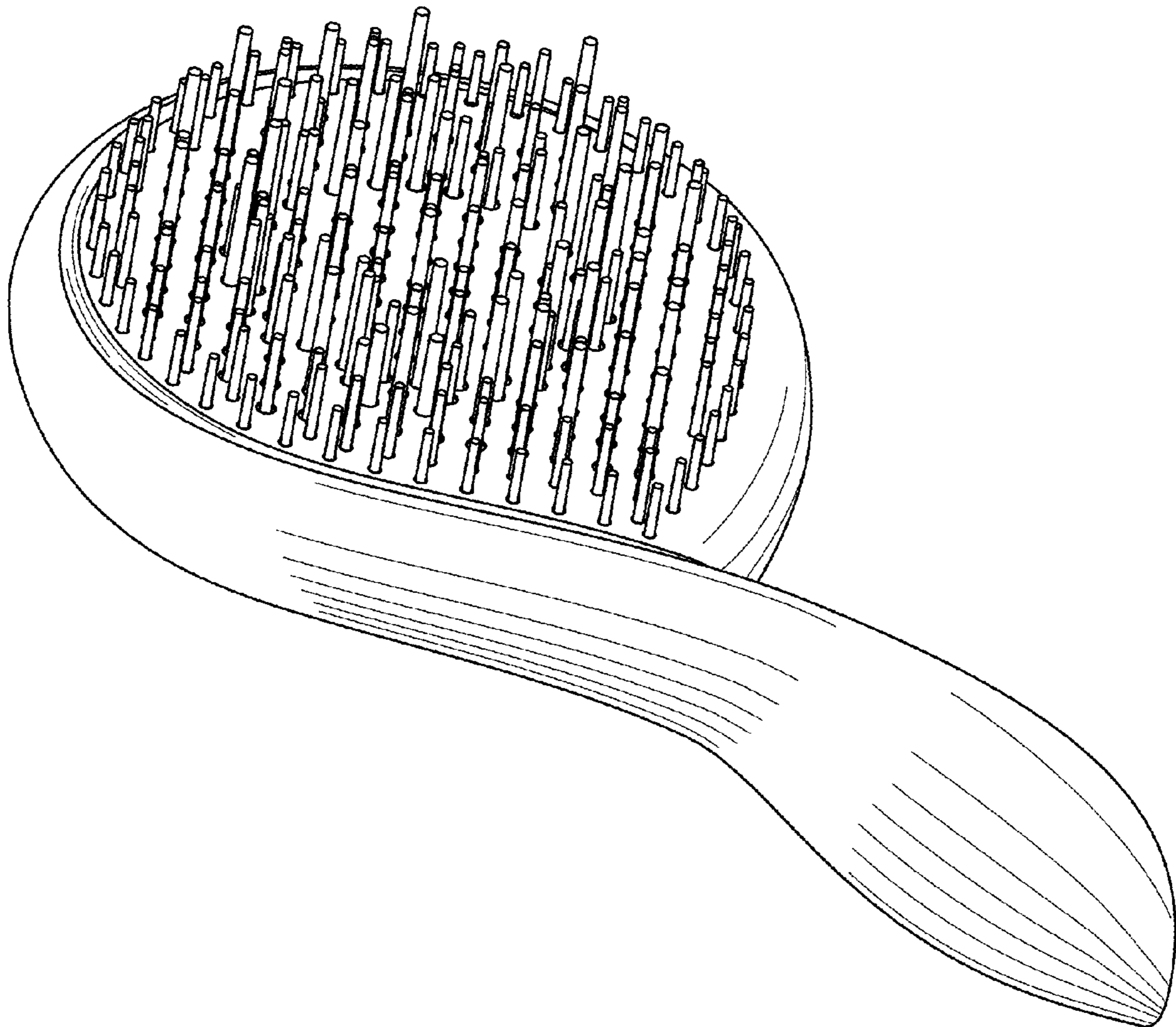

Fig. 7

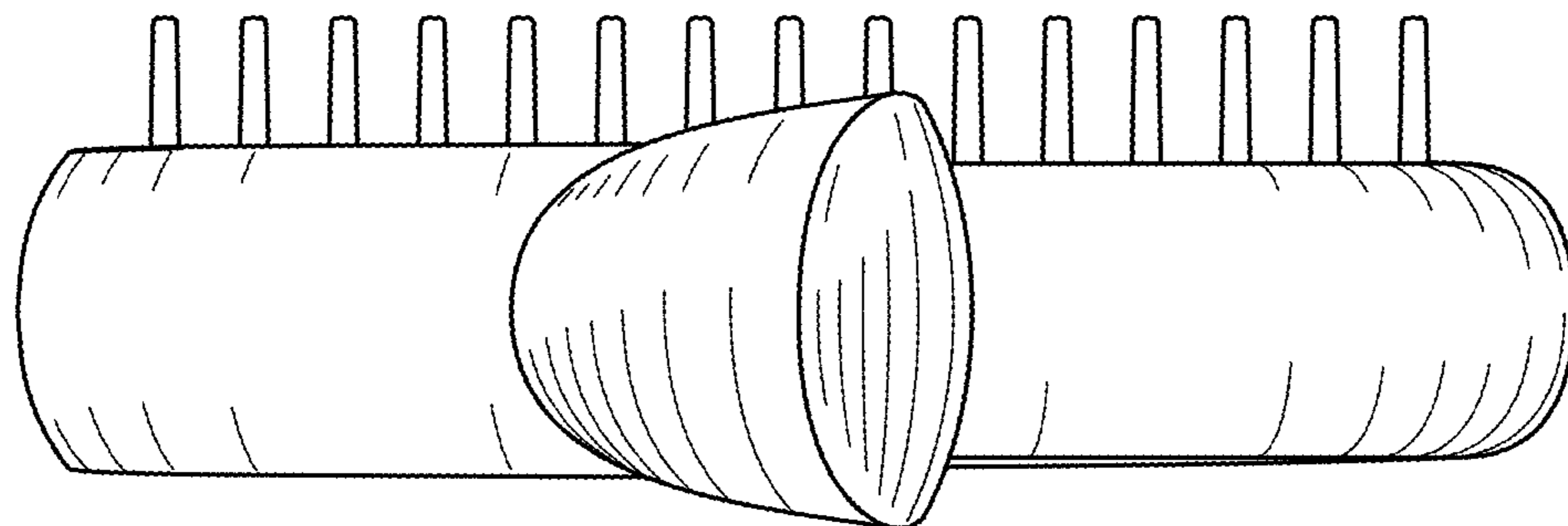

Fig. 8

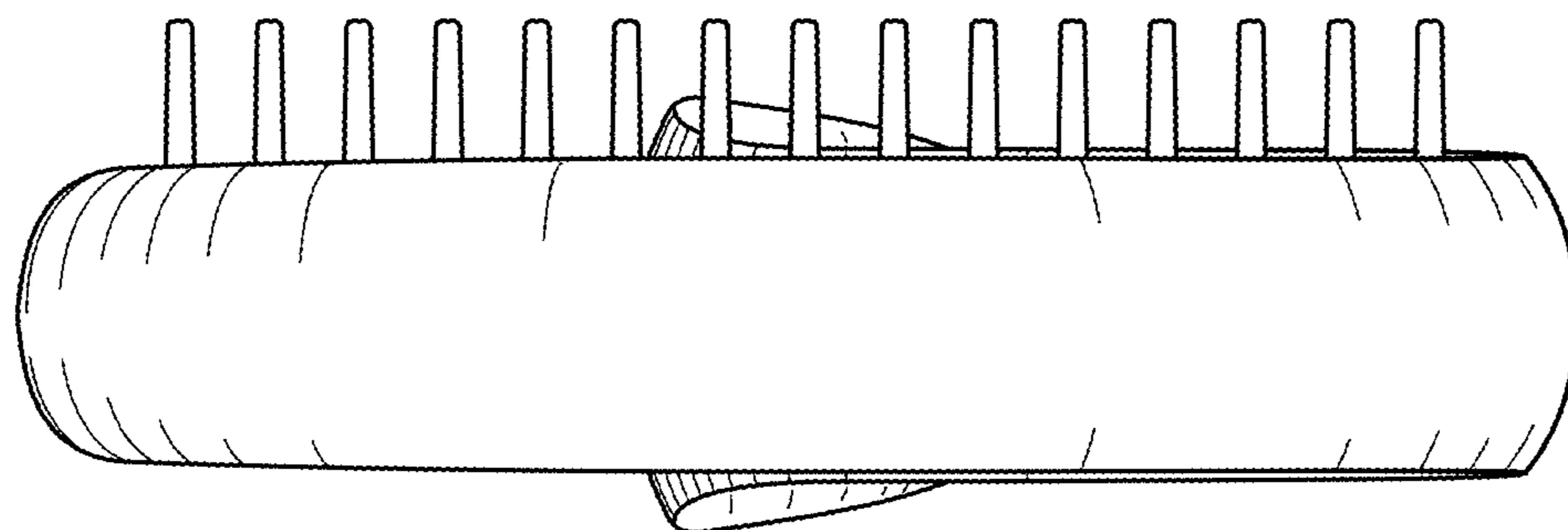

Fig. 9

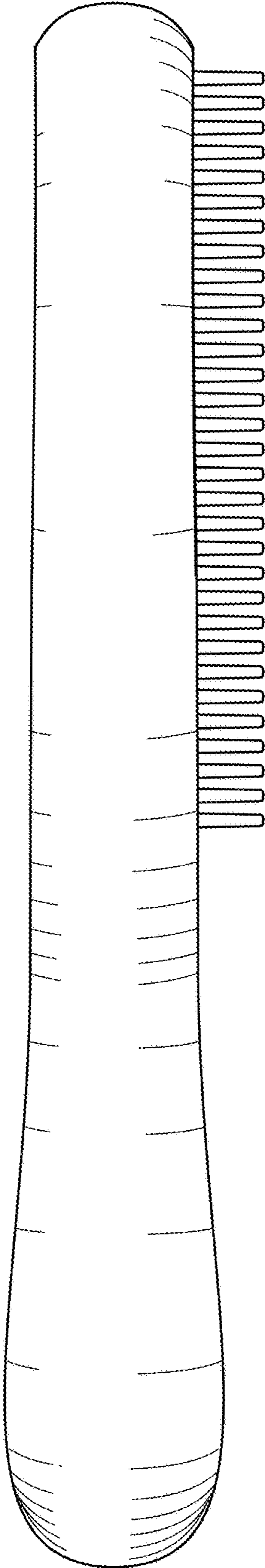

Fig. 10

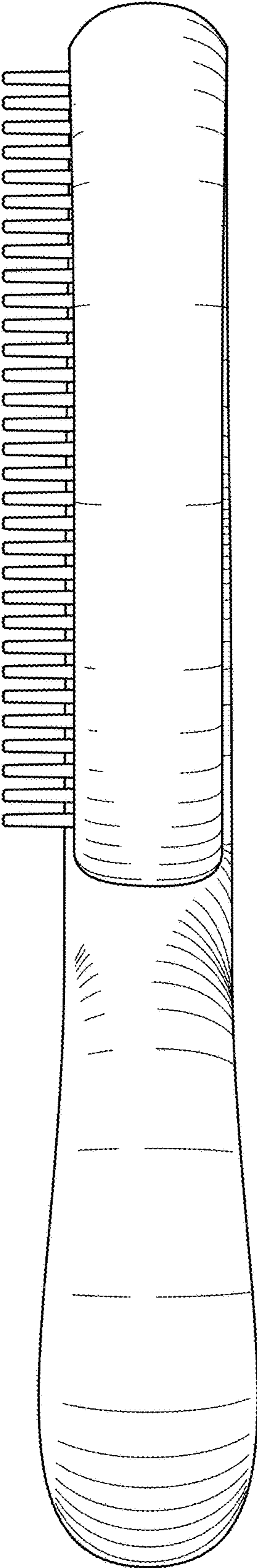

Fig. 11

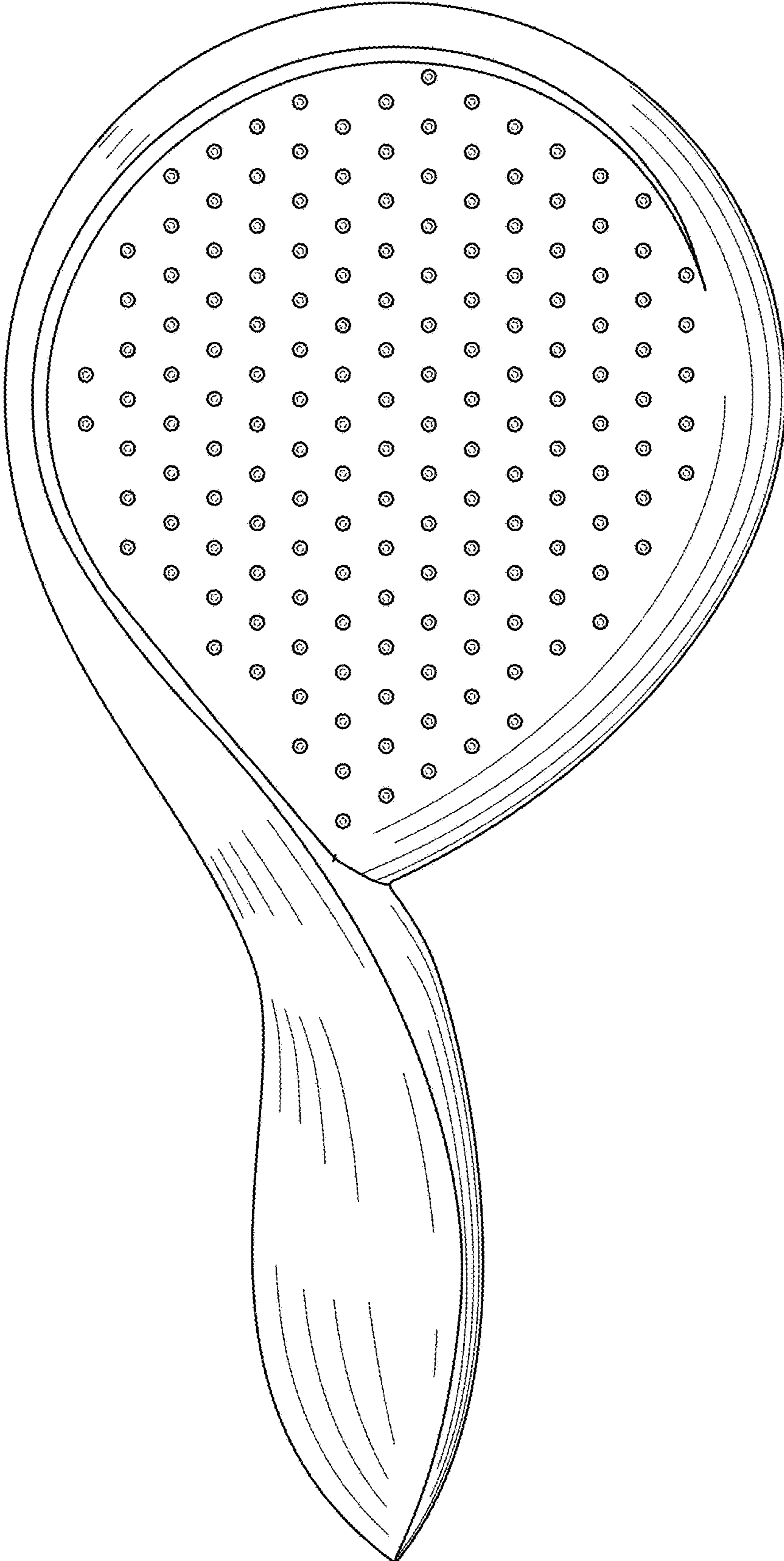

Fig. 12

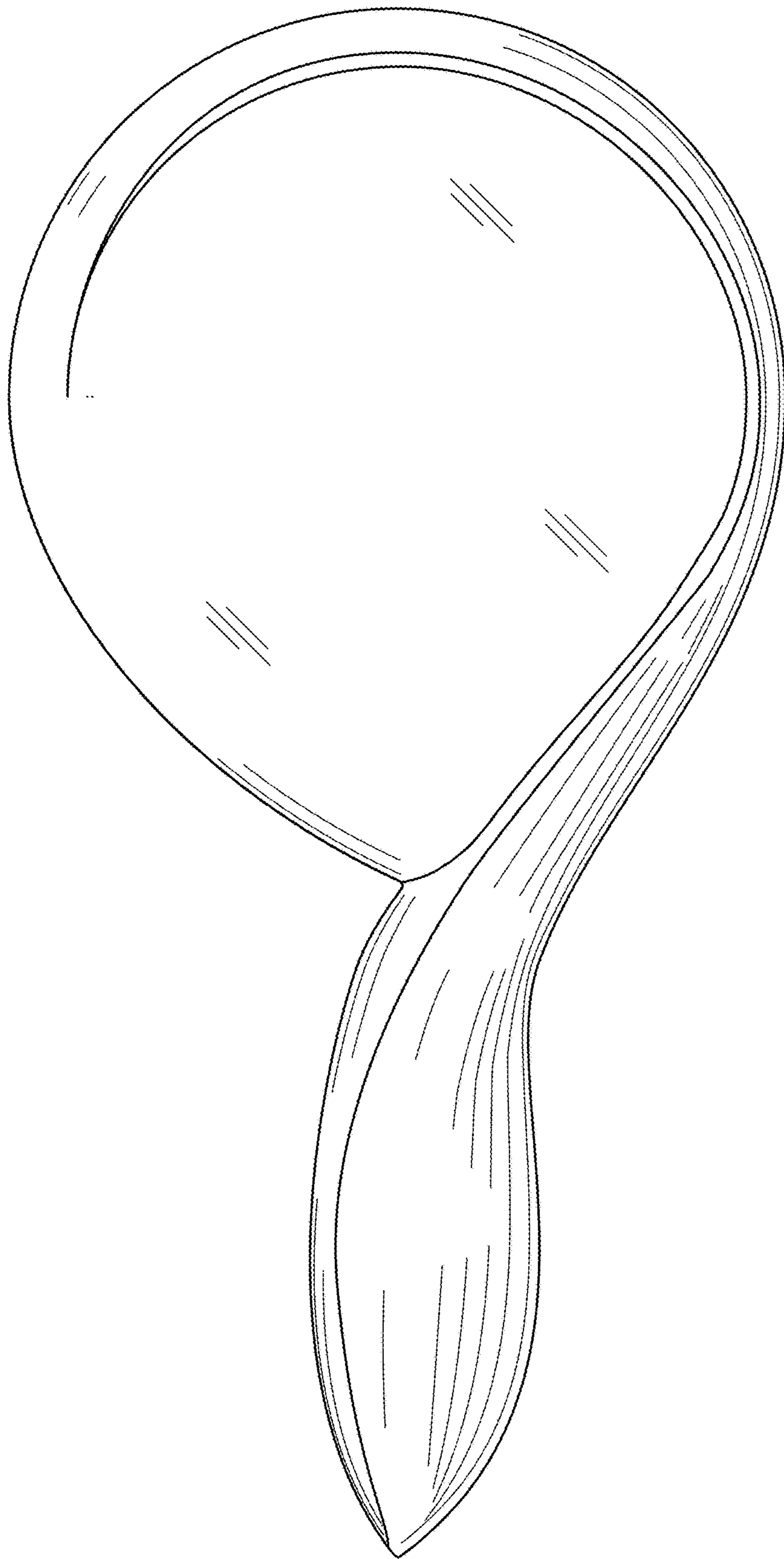

Fig. 13

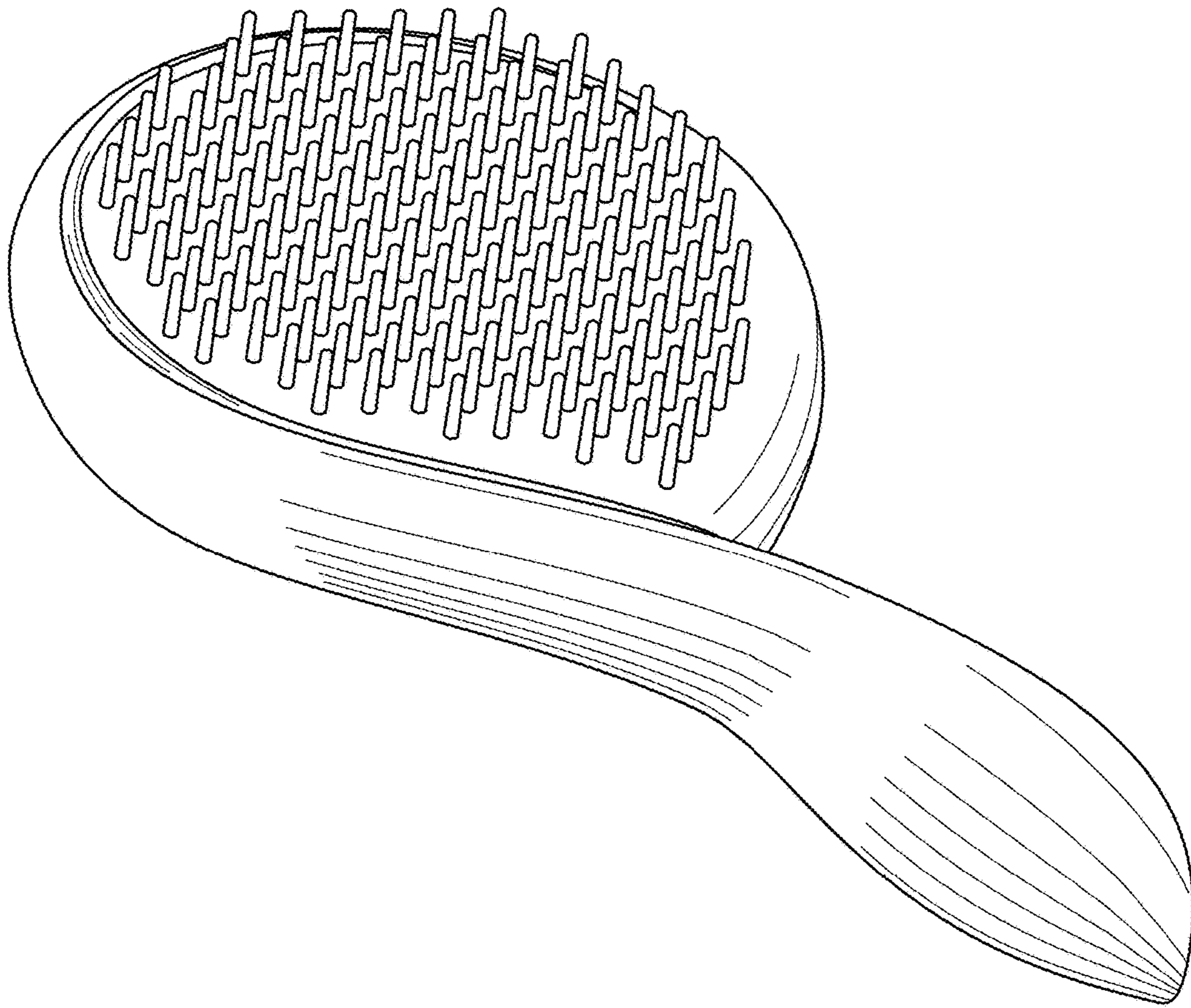

Fig. 14