



US00D803564S

(12) **United States Design Patent** (10) **Patent No.:** **US D803,564 S**
Schapiro (45) **Date of Patent:** **** Nov. 28, 2017**

(54) **STORAGE BAG**
(71) Applicant: **CLEANER'S SUPPLY, INC.**, Conklin, NY (US)
(72) Inventor: **Jeffrey Schapiro**, Conklin, NY (US)
(73) Assignee: **CLEANER'S SUPPLY, INC.**, Conklin, NY (US)
(**) Term: **15 Years**

D480,209 S * 10/2003 Davis D3/276
7,185,762 B2 * 3/2007 Ferris B65D 33/10
206/525
D549,097 S * 8/2007 Limber D3/294
D596,856 S * 7/2009 Udwin D3/289
D616,648 S * 6/2010 Logan D3/273
D624,752 S * 10/2010 Fried D3/276
D633,295 S * 3/2011 Russell D3/289
D655,085 S * 3/2012 Holbrook D3/289
D718,053 S * 11/2014 McFreen D3/279
D730,648 S * 6/2015 Lentner D3/285
D731,792 S * 6/2015 Lentner D3/285

(Continued)

(21) Appl. No.: **29/586,487**

(22) Filed: **Dec. 5, 2016**

(51) **LOC (10) Cl.** **03-01**

(52) **U.S. Cl.**
USPC **D3/289**

(58) **Field of Classification Search**
USPC D3/273, 274, 276, 279, 280, 282, 283,
D3/289, 293, 294, 905, 301, 205
CPC A45C 3/001; A45C 2003/002; A45C
2003/007; A45C 2003/008; A45C 3/12;
A45C 5/005; A45C 5/08; A45C
2011/002; A45C 11/008; A45C 13/42;
A45C 2200/10; B65D 33/10
See application file for complete search history.

(56) **References Cited**

U.S. PATENT DOCUMENTS

4,602,405 A * 7/1986 Sturman A44B 19/301
24/385
5,071,260 A * 12/1991 Poppe B65D 33/10
383/20
D407,432 S * 3/1999 Tell D19/26
D411,918 S * 7/1999 Neuman D3/276
6,161,959 A * 12/2000 Abraham A44B 19/301
24/387
D437,483 S * 2/2001 Bisbal D3/276
D451,802 S * 12/2001 Dardashti D3/294
6,328,158 B1 * 12/2001 Bisbal A45C 3/00
206/223
D479,898 S * 9/2003 Scola D3/278

OTHER PUBLICATIONS

eBay, "New Extra Large Vinyl Comforter Storage Bag 24" by 27" by 8" Fits King Size ", Accessed Aug. 3, 2017. (<http://www.ebay.com/itm/New-Extra-Large-Vinyl-Comforter-Storage-Bag-24-by-27-by-8-Fits-King-Size-/200971203348>).*

Primary Examiner — Jennifer Rivard
Assistant Examiner — April Rivas
(74) *Attorney, Agent, or Firm* — Epstein Drangel LLP;
Robert L. Epstein

(57) **CLAIM**

An ornamental design for a storage bag, substantially as shown and described.

DESCRIPTION

FIG. 1 is a perspective view showing the top, front and one side of my design;
FIG. 2 is an elevation view showing the front of my design;
FIG. 3 is an elevation view showing the back of my design;
FIG. 4 is a left side elevation view of my design;
FIG. 5 is a right side elevation view of my design;
FIG. 6 is a plan view showing the top of my design; and,
FIG. 7 is a plan view showing the bottom of my design.

1 Claim, 5 Drawing Sheets

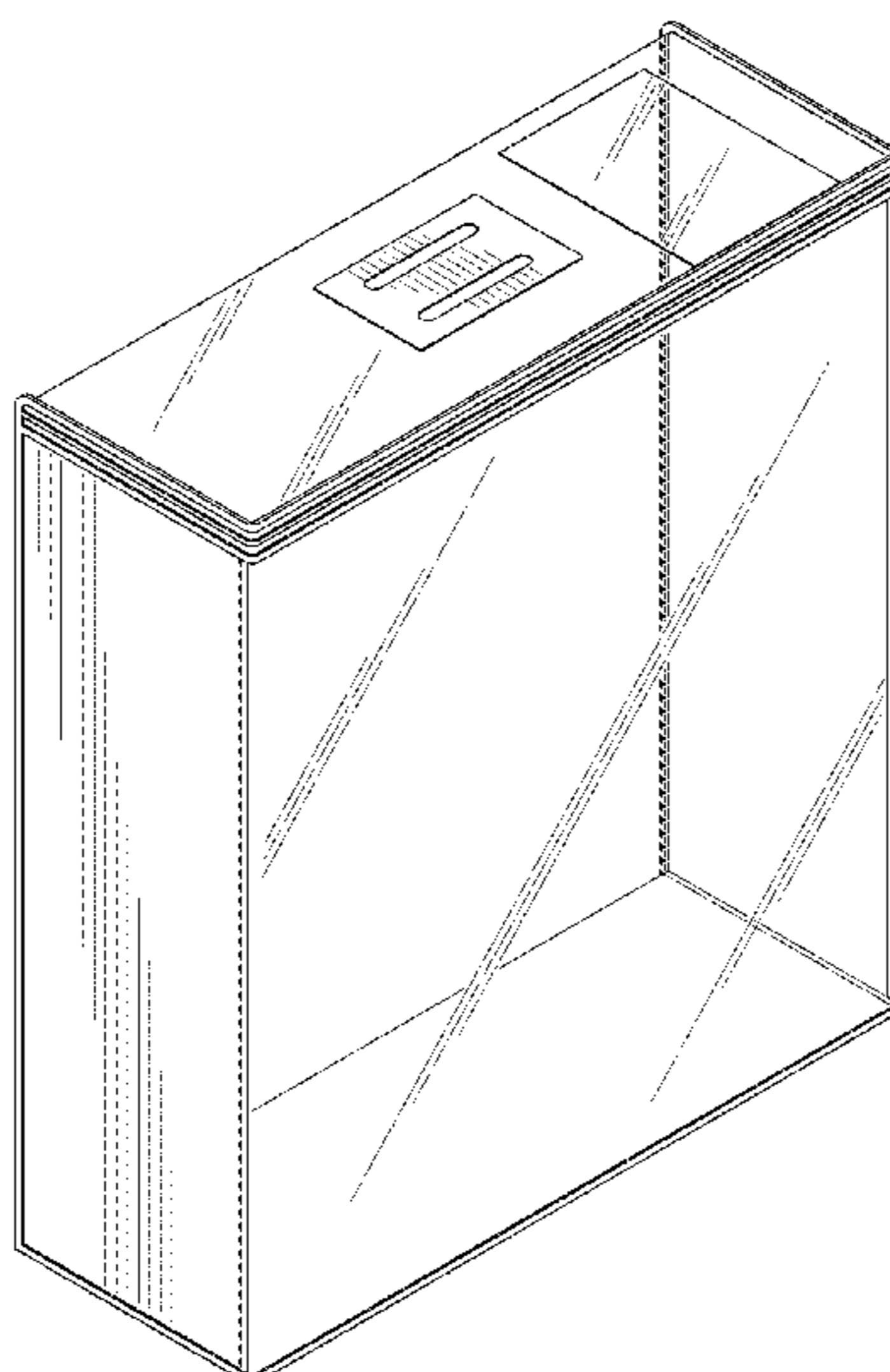

(56)

References Cited

U.S. PATENT DOCUMENTS

D747,099	S *	1/2016	Cogan	D3/278
9,565,914	B1 *	2/2017	Marraccini	A45C 13/02
2004/0070242	A1 *	4/2004	Illulian	A45C 13/26
				297/219.1
2008/0302680	A1 *	12/2008	Lord	A45C 3/00
				206/232
2010/0018888	A1 *	1/2010	Hamilton	A45C 3/004
				206/494
2013/0075284	A1 *	3/2013	Yee	B65D 27/06
				206/216
2016/0166026	A1 *	6/2016	Webster	A45C 5/03
				206/320

* cited by examiner

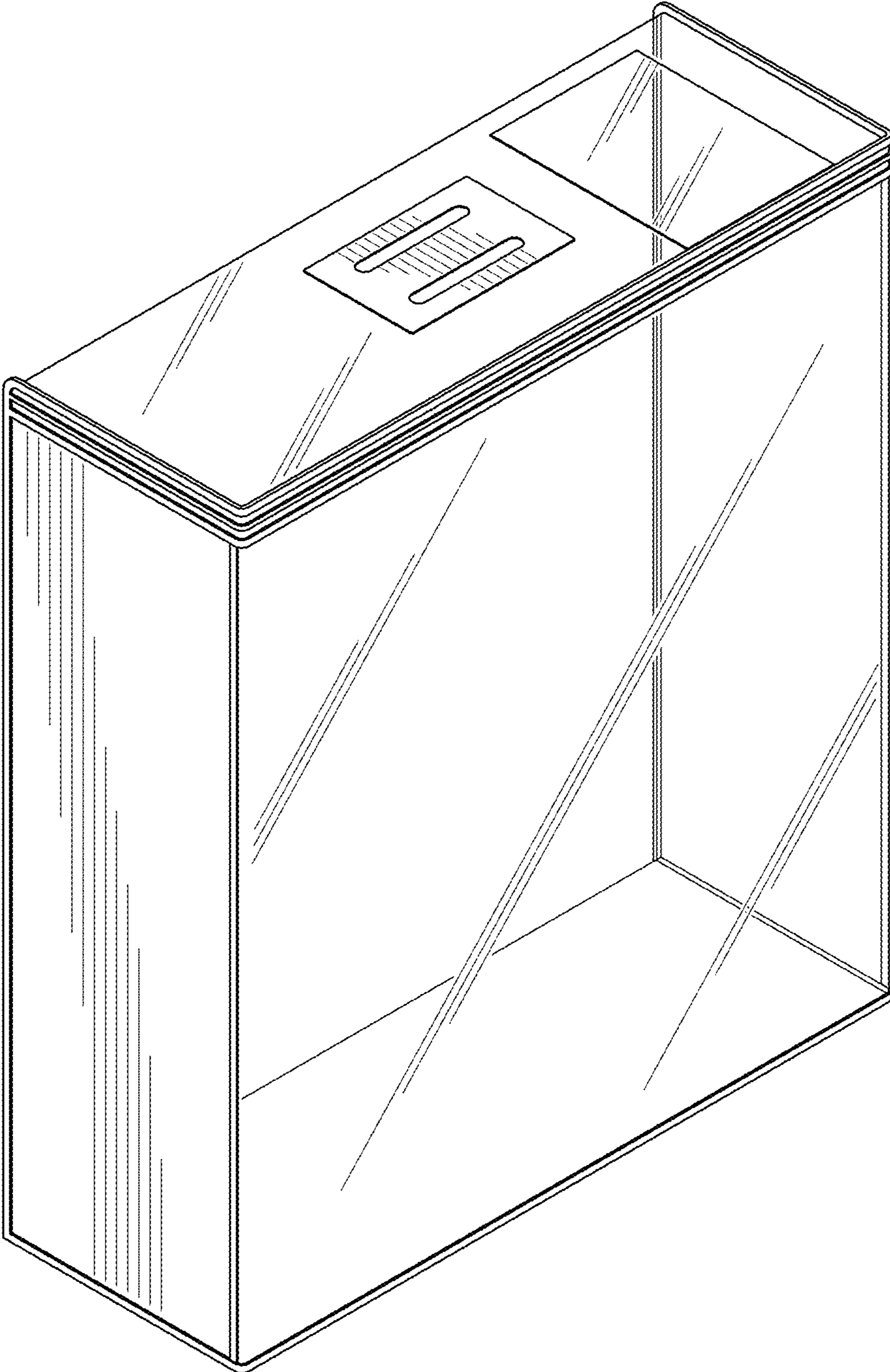

FIG. 1

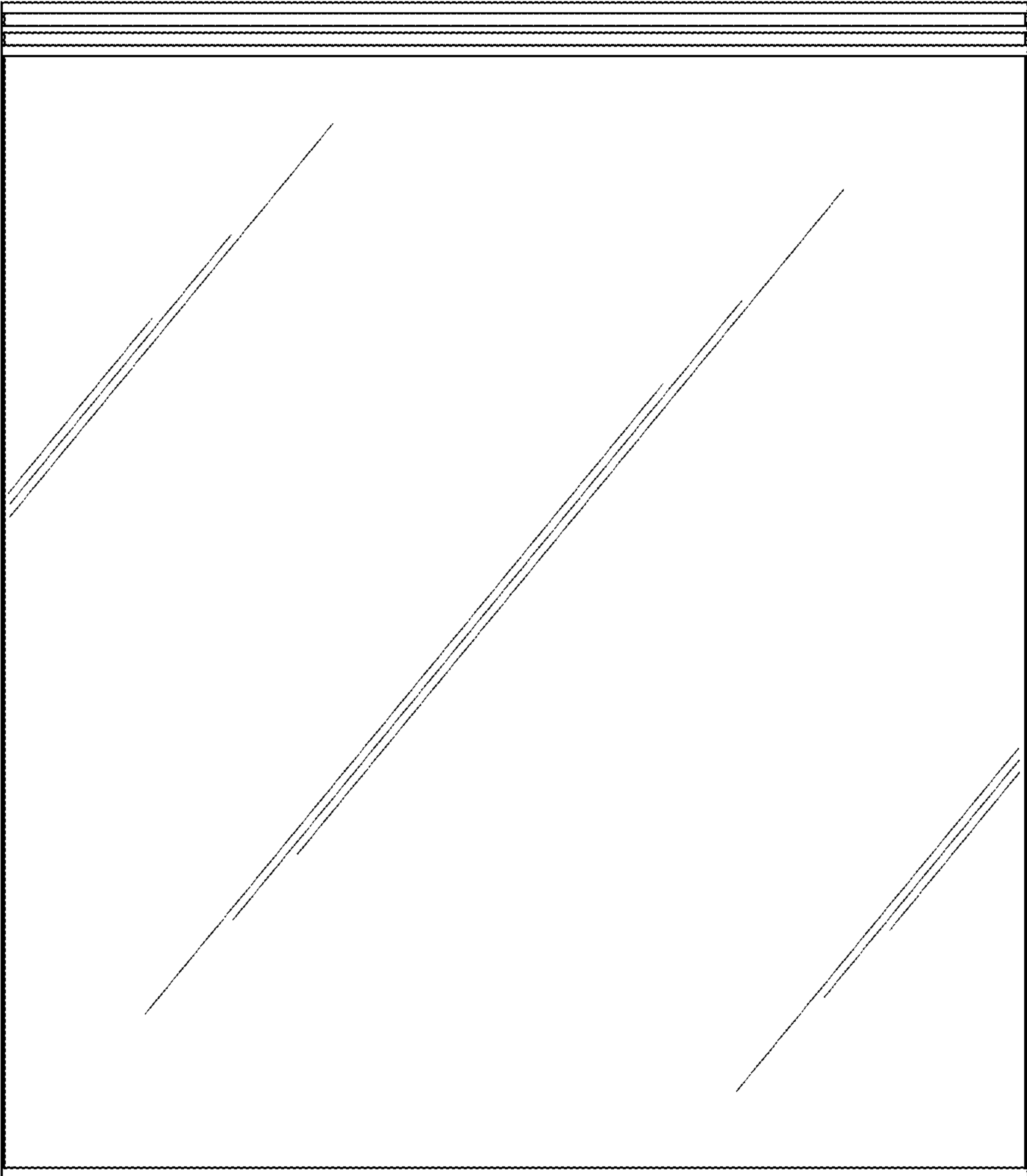

FIG. 2

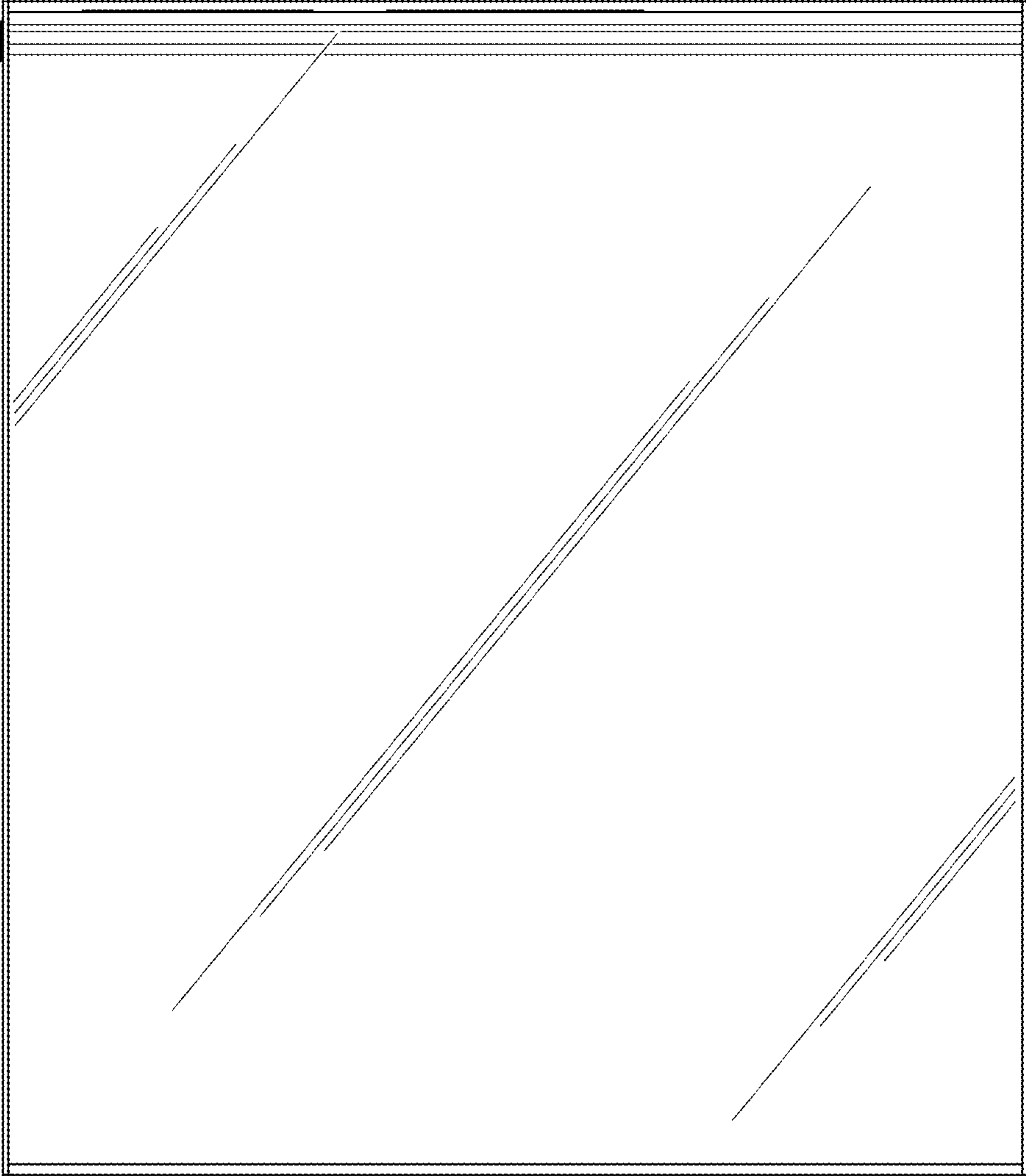

FIG. 3

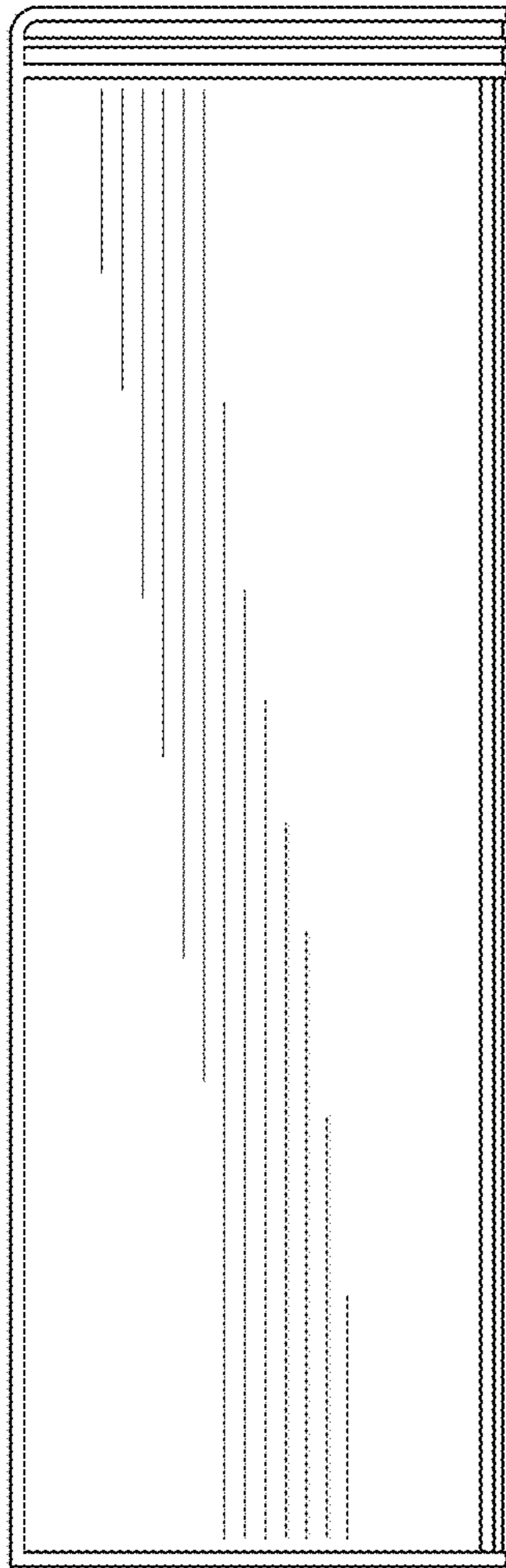

FIG. 4

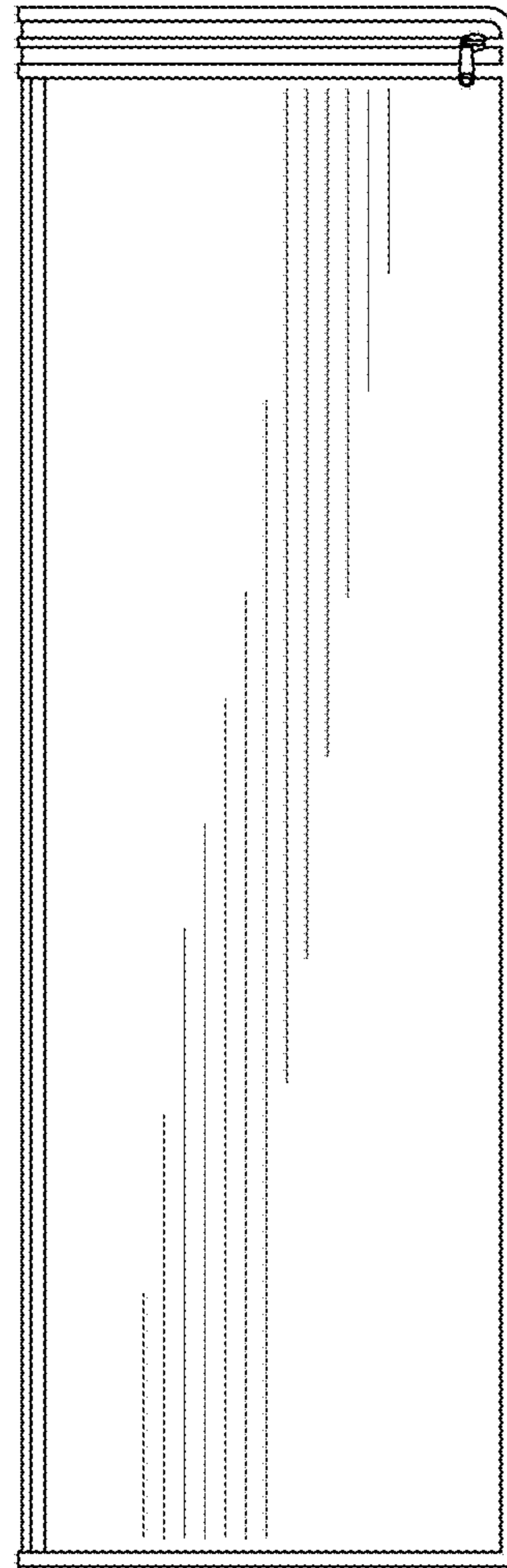

FIG. 5

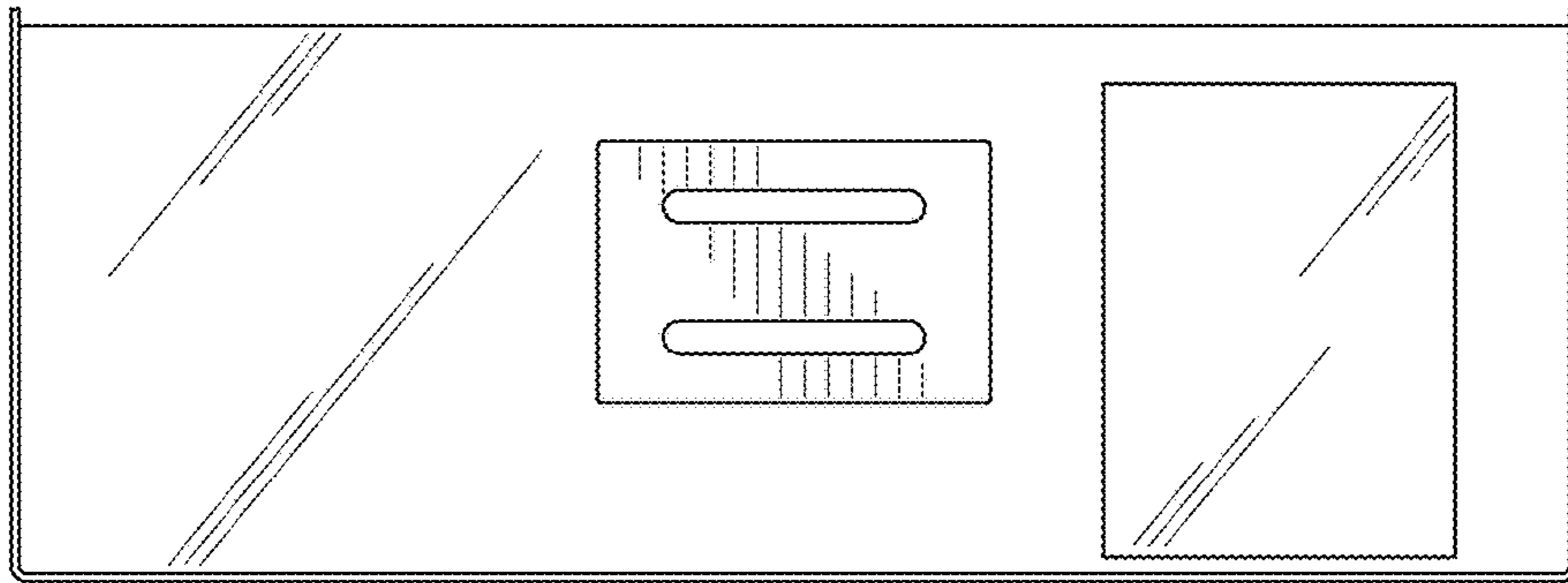

FIG. 6

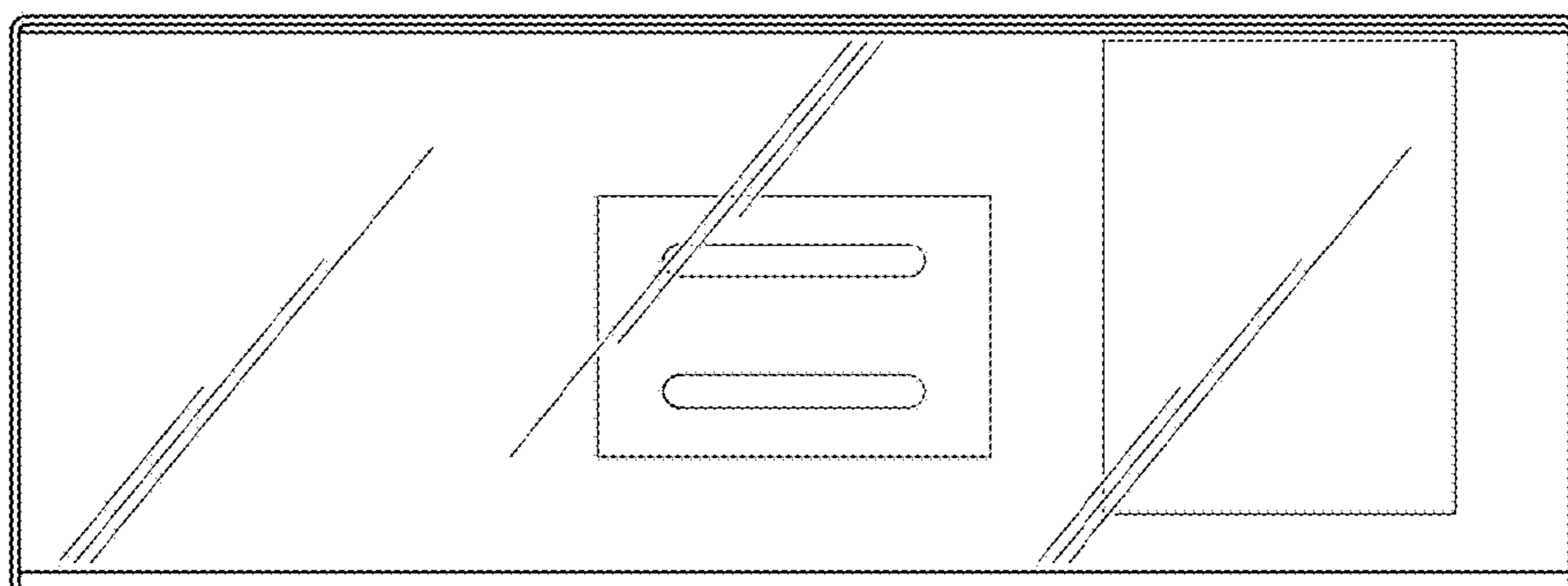

FIG. 7