



US00D803536S

(12) **United States Design Patent**  
**Strother**

(10) **Patent No.:** **US D803,536 S**

(45) **Date of Patent:** **\*\* Nov. 28, 2017**

(54) **FOOTWEAR TREAD**

(71) Applicant: **TBL Licensing LLC**, Wilmington, DE (US)

(72) Inventor: **Brian Strother**, Dover, NH (US)

(73) Assignee: **TBL Licensing LLC**, Stratham, NH (US)

(\*\*) Term: **15 Years**

(21) Appl. No.: **29/545,886**

(22) Filed: **Nov. 17, 2015**

**Related U.S. Application Data**

(62) Division of application No. 29/485,620, filed on Mar. 20, 2014, now Pat. No. Des. 764,780.

(51) **LOC (10) Cl.** ..... **02-04**

(52) **U.S. Cl.**  
USPC ..... **D2/957; D2/951; D2/959**

(58) **Field of Classification Search**  
USPC ..... D2/902, 906, 908, 916, 918, 925,  
D2/946-962, 977; 36/3 B, 22 R, 24.5,  
36/25 R, 28, 32 R, 34 R, 59 C, 67 A, 103  
(Continued)

(56) **References Cited**

**U.S. PATENT DOCUMENTS**

D80,433 S 2/1930 Chirfield  
D197,505 S 2/1964 Hingham  
(Continued)

*Primary Examiner* — T. Chase Nelson

(74) *Attorney, Agent, or Firm* — Lerner, David,  
Littenberg, Krumholz & Mentlik, LLP

(57) **CLAIM**

The ornamental design for a footwear tread, as shown and described.

**DESCRIPTION**

FIG. 1 is a perspective view of the footwear tread in accordance with a first embodiment of the ornamental design;

FIG. 2 is a top plan view of the footwear tread of the first embodiment;

FIG. 3 is a left side elevational view of the footwear tread of the first embodiment;

FIG. 4 is a right side elevational view of the footwear tread of the first embodiment;

FIG. 5 is a rear elevational view of the footwear tread of the first embodiment;

FIG. 6 is a front elevational view of the footwear tread of the first embodiment;

FIG. 7 is a perspective view of the footwear tread in accordance with a second embodiment of the ornamental design;

FIG. 8 is a top plan view of the footwear tread of the second embodiment;

FIG. 9 is a left side elevational view of the footwear tread of the second embodiment;

FIG. 10 is a right side elevational view of the footwear tread of the second embodiment;

FIG. 11 is a rear elevational view of the footwear tread of the second embodiment;

FIG. 12 is a front elevational view of the footwear tread of the second embodiment;

FIG. 13 is a perspective view of the footwear tread in accordance with a third embodiment of the ornamental design;

FIG. 14 is a top plan view of the footwear tread of the third embodiment;

FIG. 15 is a left side elevational view of the footwear tread of the third embodiment;

FIG. 16 is a right side elevational view of the footwear tread of the third embodiment;

FIG. 17 is a rear elevational view of the footwear tread of the third embodiment;

FIG. 18 is a front elevational view of the footwear tread of the third embodiment;

FIG. 19 is a perspective view of the footwear tread in accordance with a fourth embodiment of the ornamental design;

FIG. 20 is a top plan view of the footwear tread of the fourth embodiment;

FIG. 21 is a left side elevational view of the footwear tread of the fourth embodiment;

(Continued)

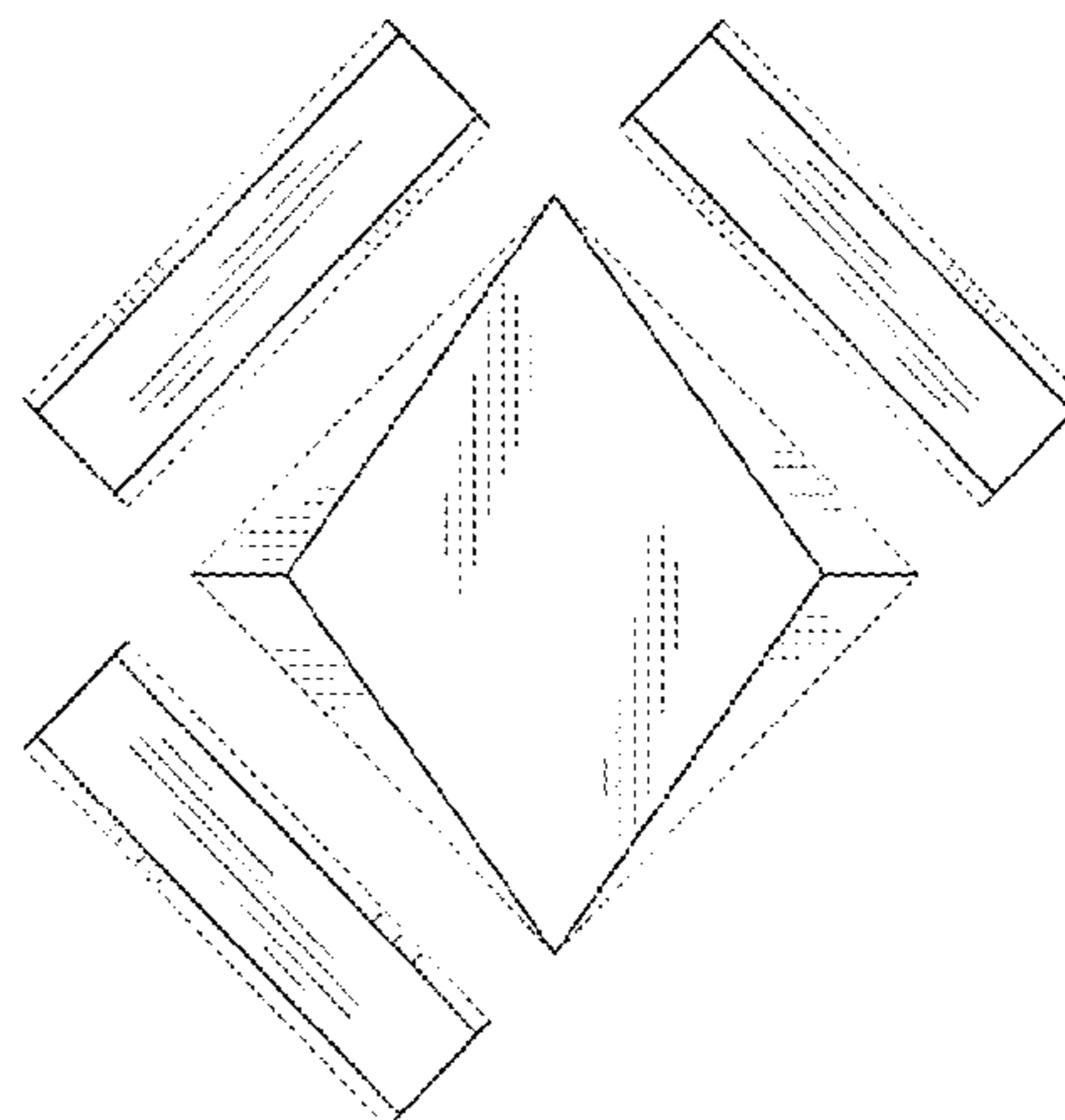
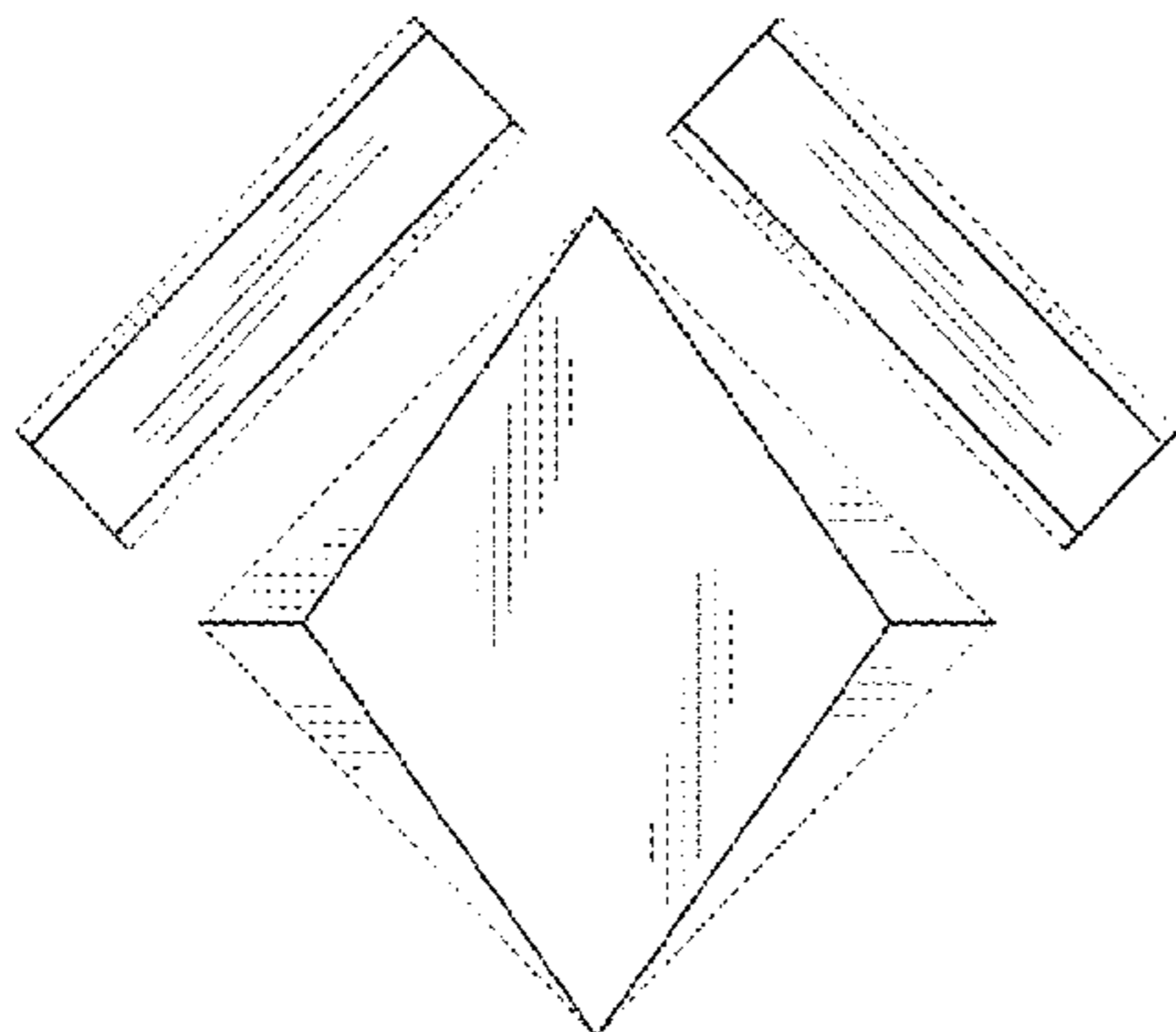

FIG. 22 is a right side elevational view of the footwear tread of the fourth embodiment;  
 FIG. 23 is a rear elevational view of the footwear tread of the fourth embodiment;  
 FIG. 24 is a front elevational view of the footwear tread of the fourth embodiment;  
 FIG. 25 is a perspective view of the footwear tread in accordance with a fifth embodiment of the ornamental design;  
 FIG. 26 is a top plan view of the footwear tread of the fifth embodiment;  
 FIG. 27 is a left side elevational view of the footwear tread of the fifth embodiment;  
 FIG. 28 is a right side elevational view of the footwear tread of the fifth embodiment;  
 FIG. 29 is a rear elevational view of the footwear tread of the fifth embodiment;  
 FIG. 30 is a front elevational view of the footwear tread of the fifth embodiment;  
 FIG. 31 is a perspective view of the footwear tread in accordance with a sixth embodiment of the ornamental design;  
 FIG. 32 is a top plan view of the footwear tread of the sixth embodiment;  
 FIG. 33 is a left side elevational view of the footwear tread of the sixth embodiment;  
 FIG. 34 is a right side elevational view of the footwear tread of the sixth embodiment;  
 FIG. 35 is a rear elevational view of the footwear tread of the sixth embodiment; and,  
 FIG. 36 is a front elevational view of the footwear tread of the sixth embodiment.  
 Broken lines are environmental only and form no part of the claimed design. Broken lines adjacent shaded areas of the design represent the bounds of the claimed design and are not themselves a part of the claimed design.

**1 Claim, 12 Drawing Sheets**

(58) **Field of Classification Search**

CPC ..... A43B 13/00; A43B 13/02; A43B 13/023;  
 A43B 13/026; A43B 13/04; A43B 13/08;  
 A43B 13/10; A43B 13/12; A43B 13/14;  
 A43B 13/141; A43B 13/143; A43B  
 13/16; A43B 13/18; A43B 13/181; A43B  
 13/187; A43B 13/189; A43B 13/20; A43B  
 13/22; A43B 13/223; A43B 13/24; A43B  
 13/28; A43B 13/30; A43B 13/32; A43B  
 13/34; A43B 13/36

See application file for complete search history.

(56) **References Cited**

U.S. PATENT DOCUMENTS

D296,724 S 7/1988 Peterson  
 D354,845 S 1/1995 Bramani

D355,754 S	2/1995	Brandon	
D373,897 S	9/1996	Takatani et al.	
5,806,209 A	9/1998	Crowley et al.	
D402,095 S	12/1998	Cretinon	
D405,597 S	2/1999	Carlson	
D406,691 S	3/1999	McDowell	
D407,193 S	3/1999	Doxey	
D460,608 S	7/2002	Laberge et al.	
D476,740 S	7/2003	De Carvalho et al.	
D476,799 S	7/2003	Fuerst	
D490,596 S	6/2004	Belley et al.	
D491,944 S	6/2004	Lutnick et al.	
D495,480 S *	9/2004	Laberge .....	D2/953
D499,536 S	12/2004	Castleberry	
D504,205 S	4/2005	Andrews-Kramer	
D507,398 S	7/2005	Recchi	
D513,112 S	12/2005	Le	
D515,291 S	2/2006	Sonnergren	
D524,520 S	7/2006	Marvin	
D531,394 S	11/2006	Bonnemere	
D547,038 S	7/2007	Nakano	
D553,334 S	10/2007	Belley et al.	
D556,987 S	12/2007	Nakano	
D558,434 S	1/2008	Roth	
D561,439 S	2/2008	Schoenborn et al.	
D566,938 S	4/2008	Matis et al.	
D570,582 S	6/2008	Roy et al.	
D570,584 S	6/2008	Gay	
D574,583 S	8/2008	St-Louis et al.	
D574,584 S	8/2008	Earle	
D580,141 S	11/2008	Banik et al.	
D595,036 S	6/2009	Link	
D602,237 S	10/2009	Roundhouse	
D604,933 S	12/2009	Anderson	
D619,344 S	7/2010	Favreau et al.	
D620,243 S	7/2010	McClaskie	
D620,692 S	8/2010	McClaskie	
D635,754 S	4/2011	Mariman	
D663,518 S	7/2012	McClaskie	
D664,343 S	7/2012	McClaskie	
D677,453 S	3/2013	Sakai	
D677,455 S *	3/2013	Pizzuti .....	D2/951
D707,933 S	7/2014	McCourt	
D736,509 S	8/2015	Bikowski	
D743,678 S *	11/2015	Dombrow .....	D2/951
D744,733 S *	12/2015	Adam .....	D2/951
D746,563 S *	1/2016	Dombrow .....	D2/951
D749,310 S *	2/2016	Greenhalgh .....	D2/951
D755,490 S *	5/2016	Nakano .....	D2/951
D756,094 S *	5/2016	Nyssen .....	D2/951
D758,709 S *	6/2016	Youn .....	D2/962
D767,260 S *	9/2016	Lubart .....	D2/909
D767,265 S *	9/2016	Brown .....	D2/951
D768,369 S *	10/2016	Padilla .....	D2/951
D771,362 S *	11/2016	Dombrow .....	D2/951
D773,165 S *	12/2016	Youn .....	D2/962
D779,177 S *	2/2017	Gibson .....	D2/951
D785,305 S *	5/2017	Adam .....	D2/951
D790,184 S *	6/2017	Engel .....	D2/951
D790,824 S *	7/2017	Shen .....	D2/951
2003/0172548 A1	9/2003	Fuerst	
2005/0072026 A1	4/2005	Sink	
2010/0170106 A1 *	7/2010	Brewer .....	A43B 7/24 36/28
2012/0000095 A1	1/2012	Torrance	
2012/0110876 A1	5/2012	Lubart	
2015/0223560 A1	8/2015	Wawrousek et al.	

\* cited by examiner

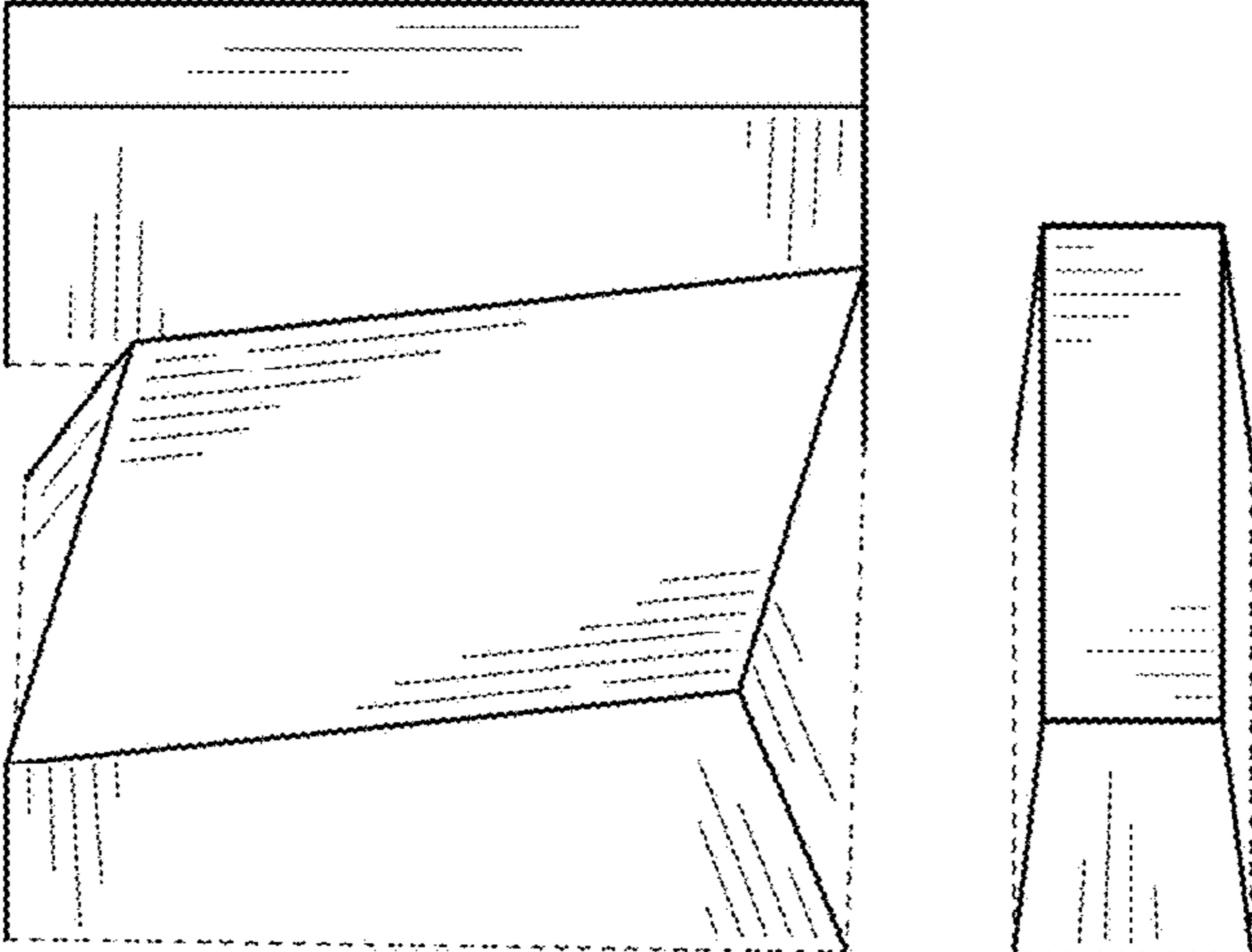

FIG. 1

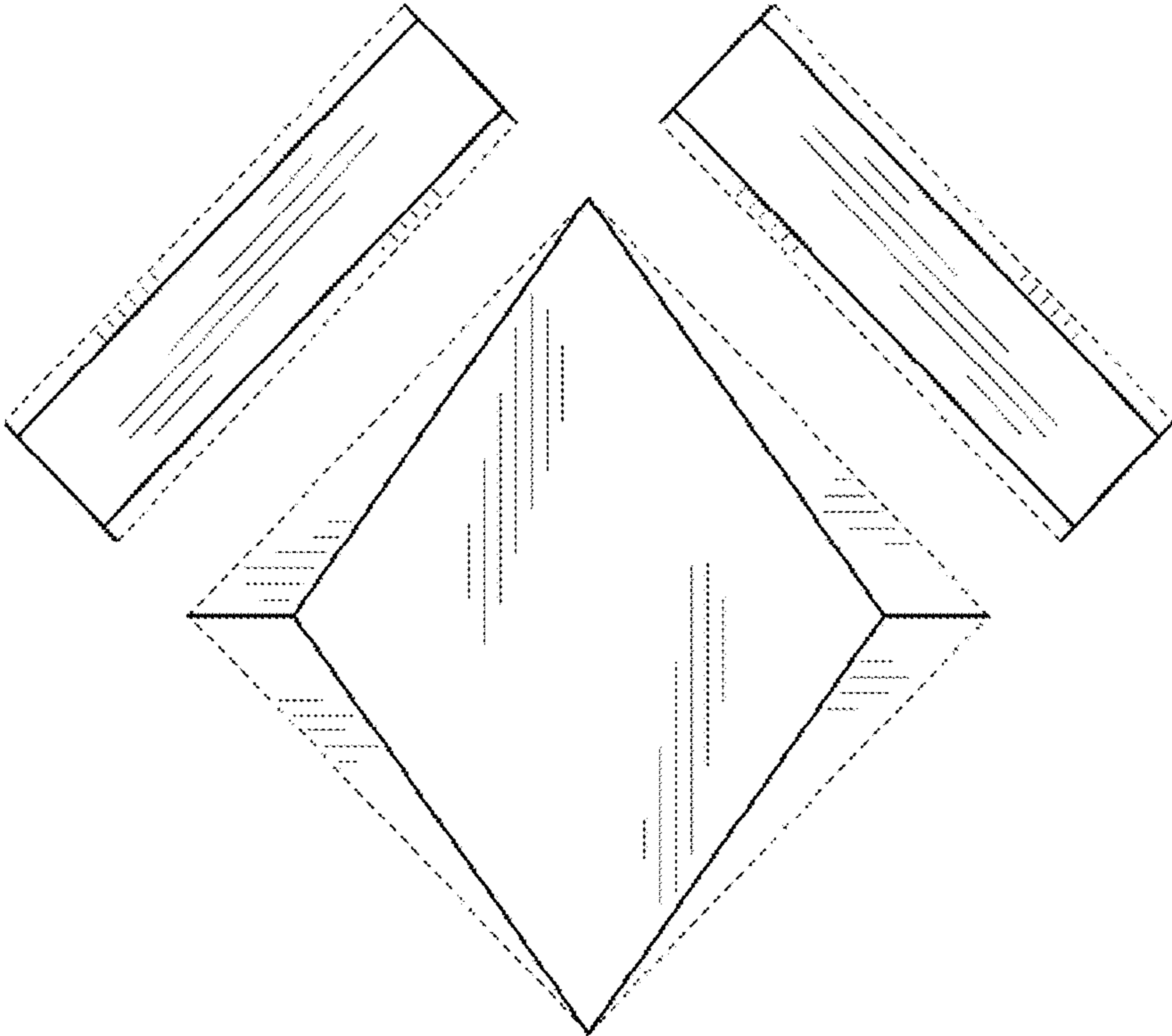

FIG. 2

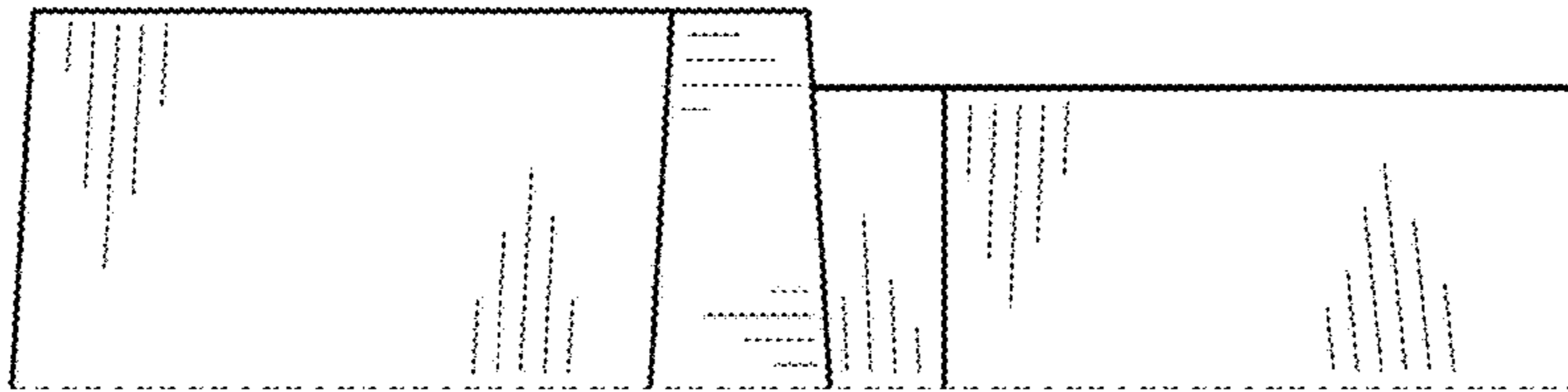

FIG. 3

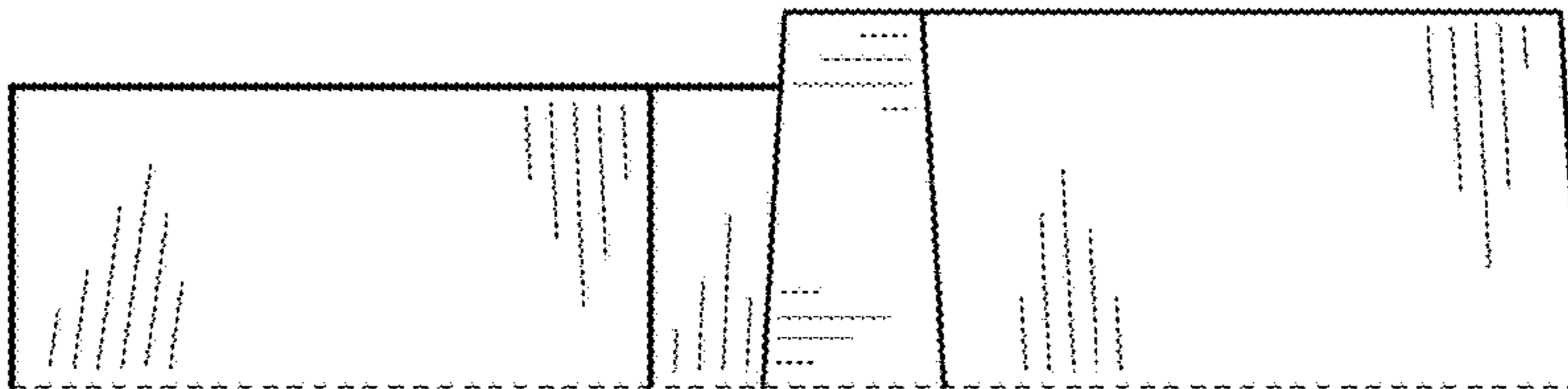

FIG. 4

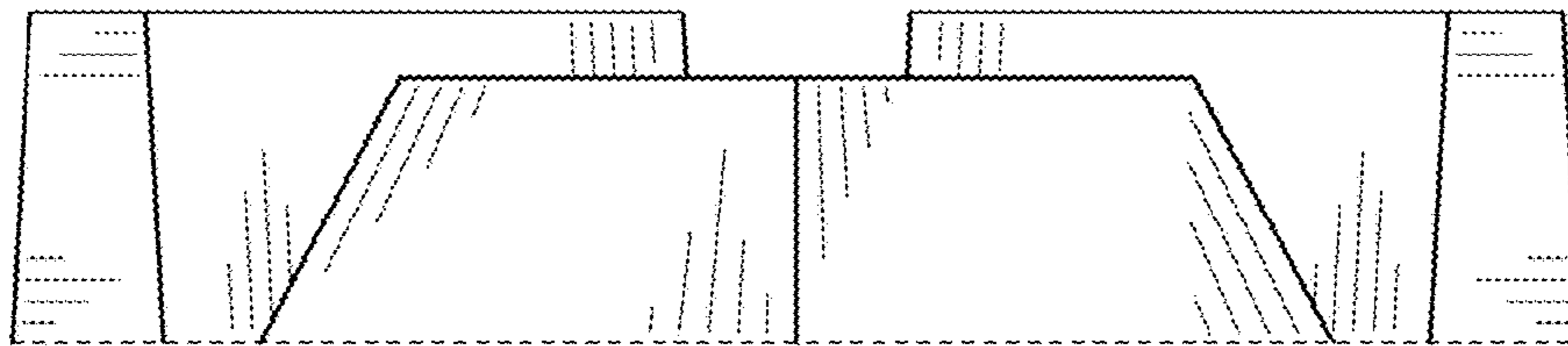

FIG. 5

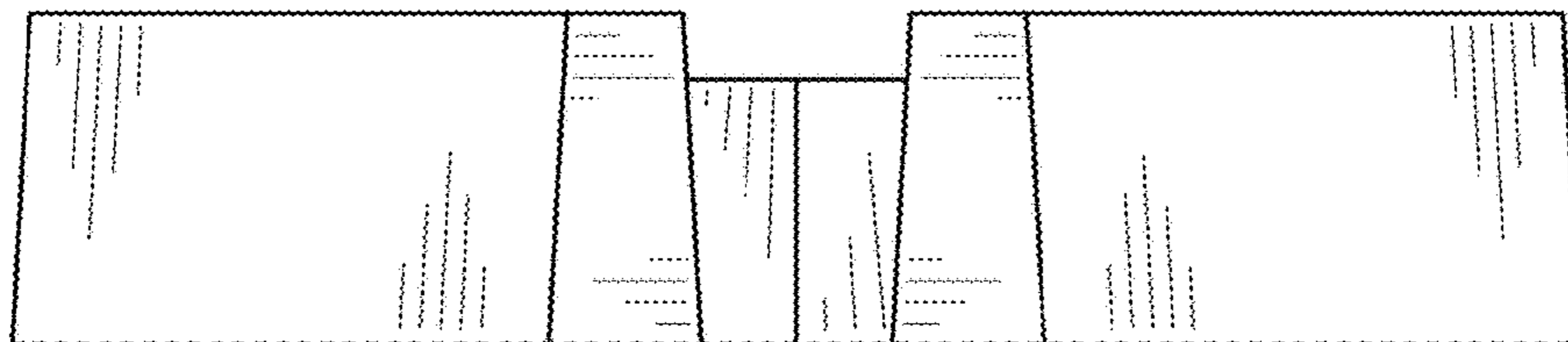

FIG. 6

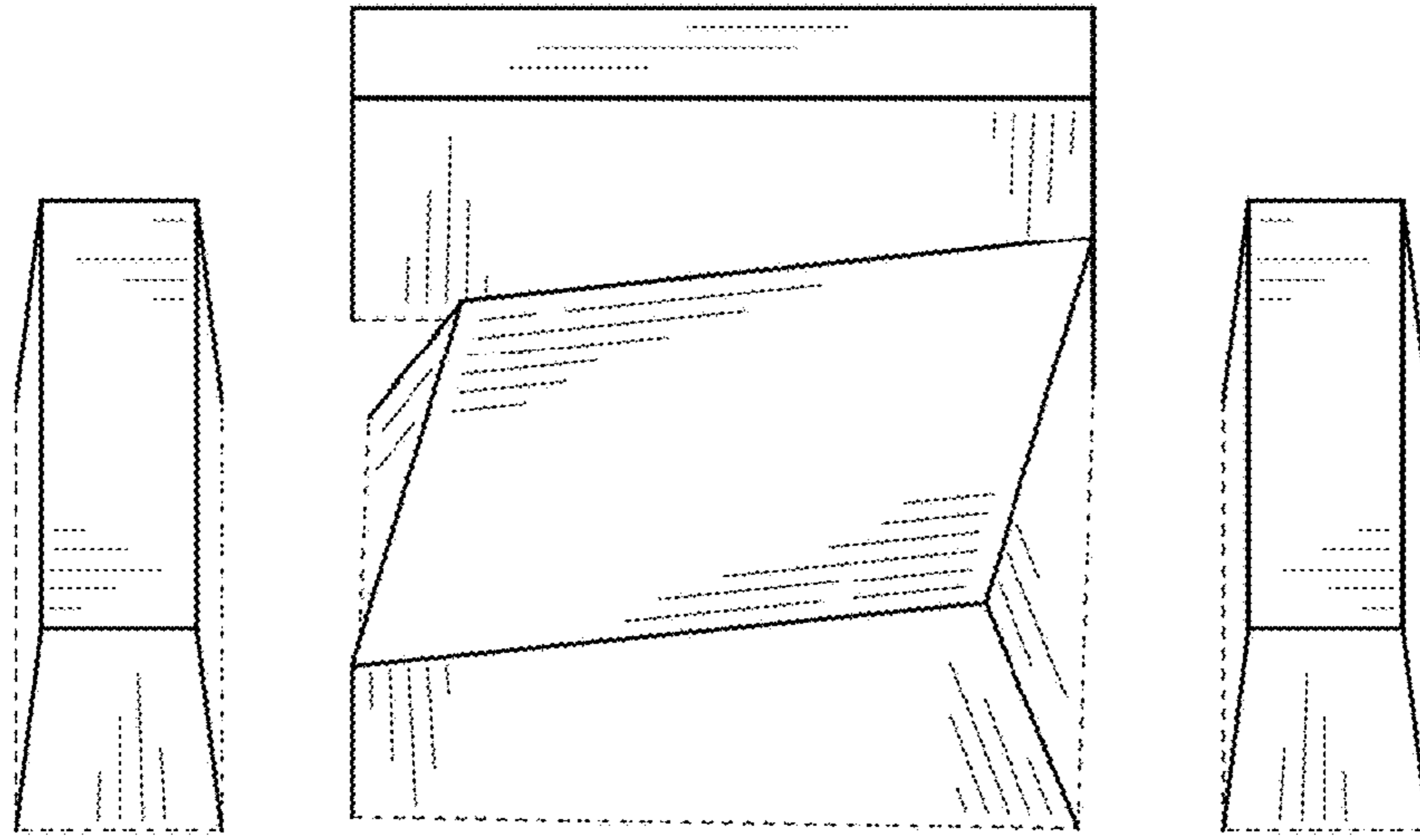

FIG. 7

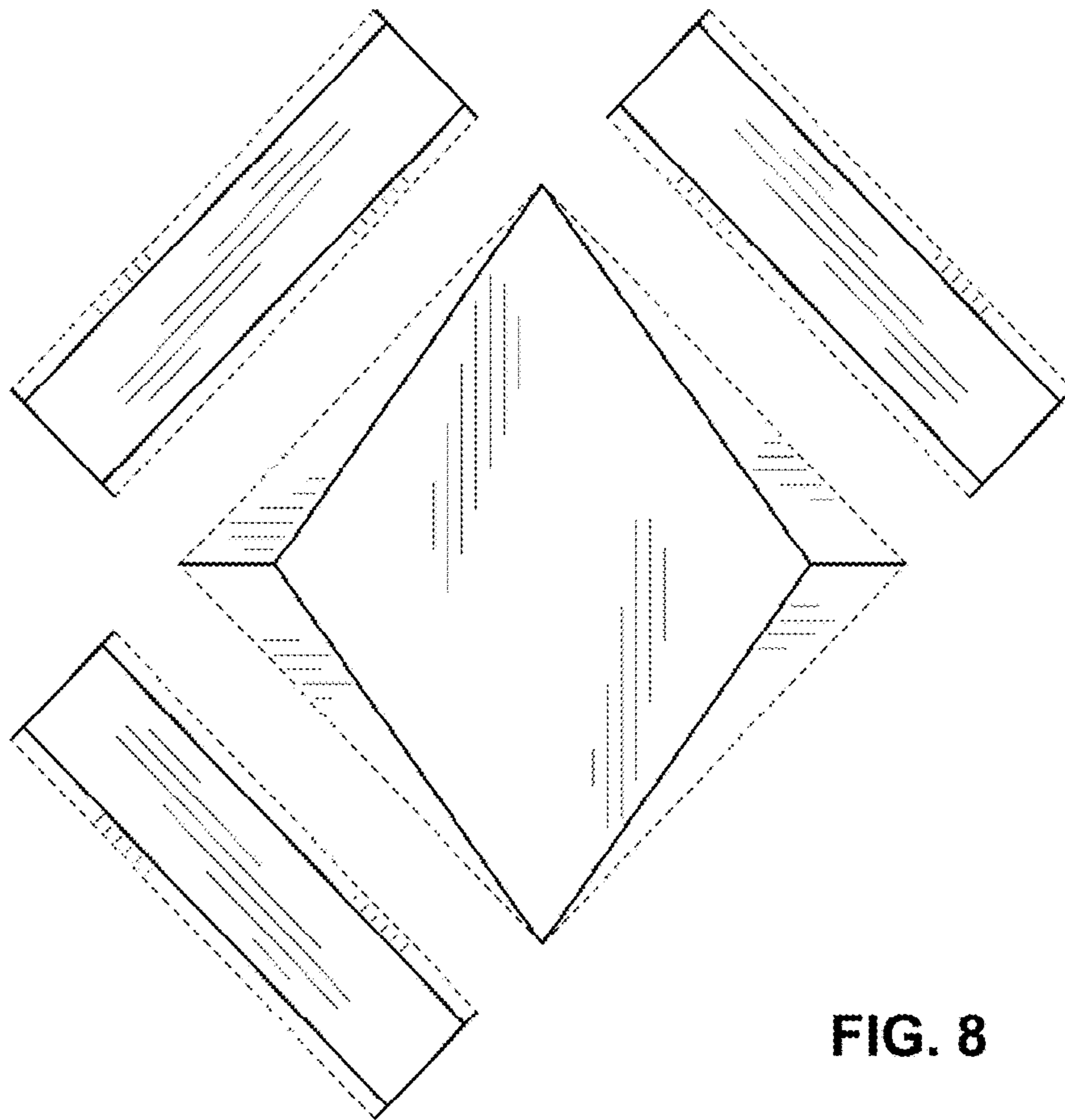

FIG. 8

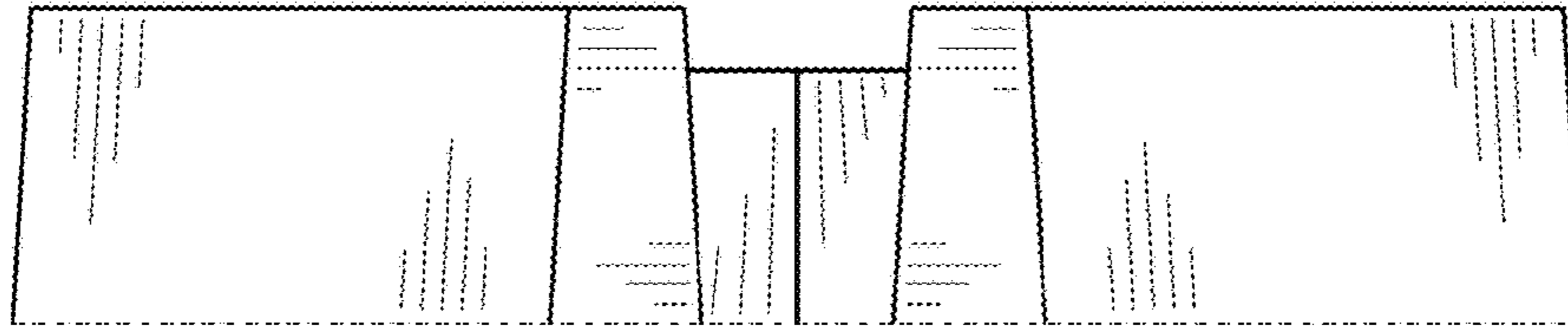

FIG. 9

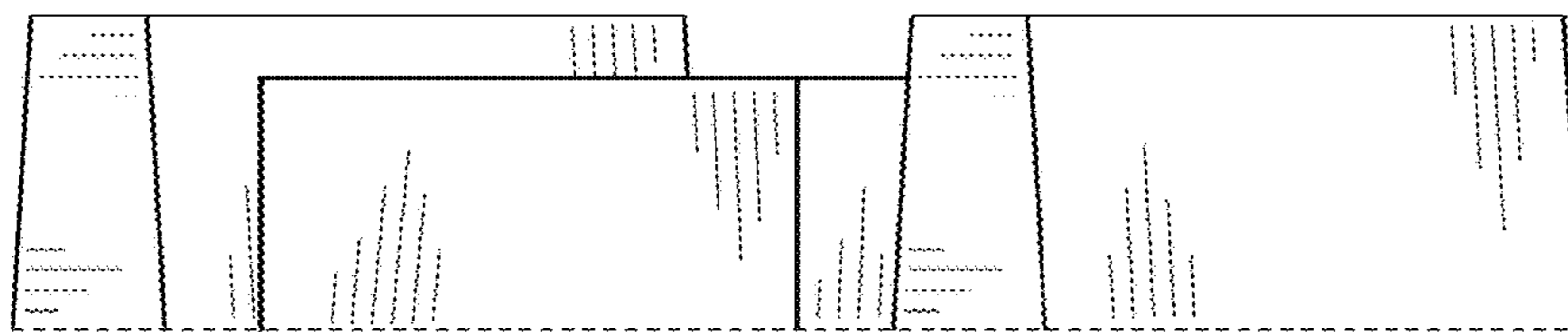

FIG. 10

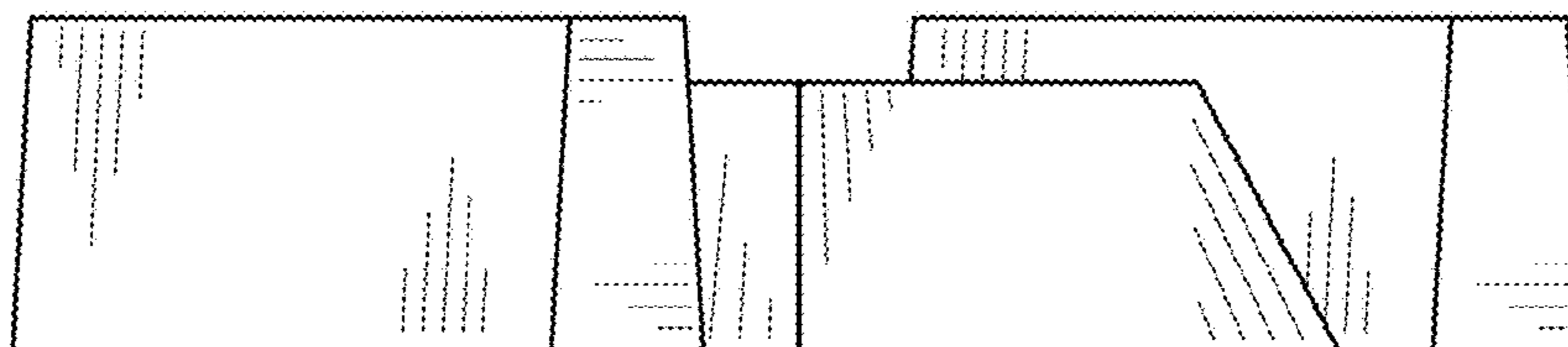

FIG. 11

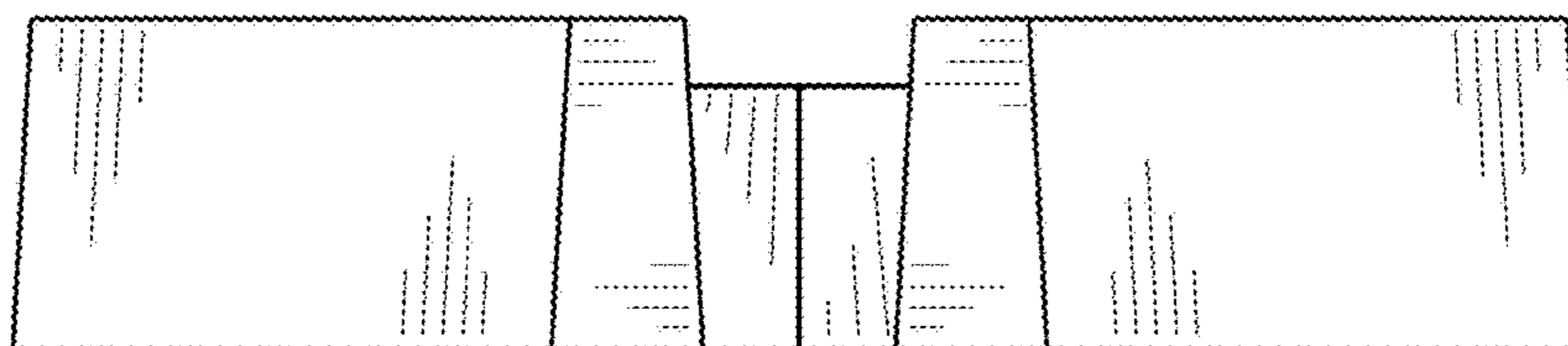

FIG. 12

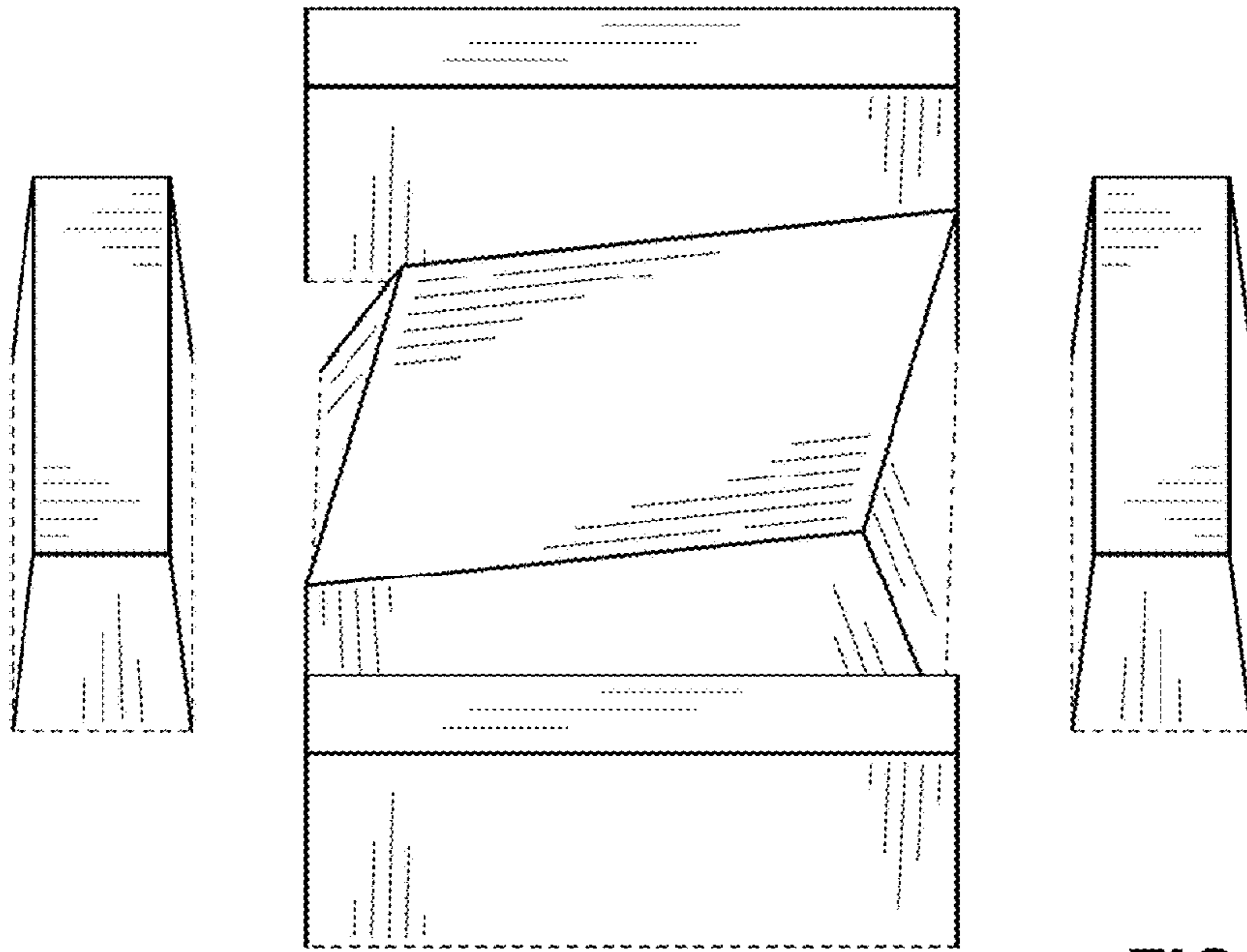

FIG. 13

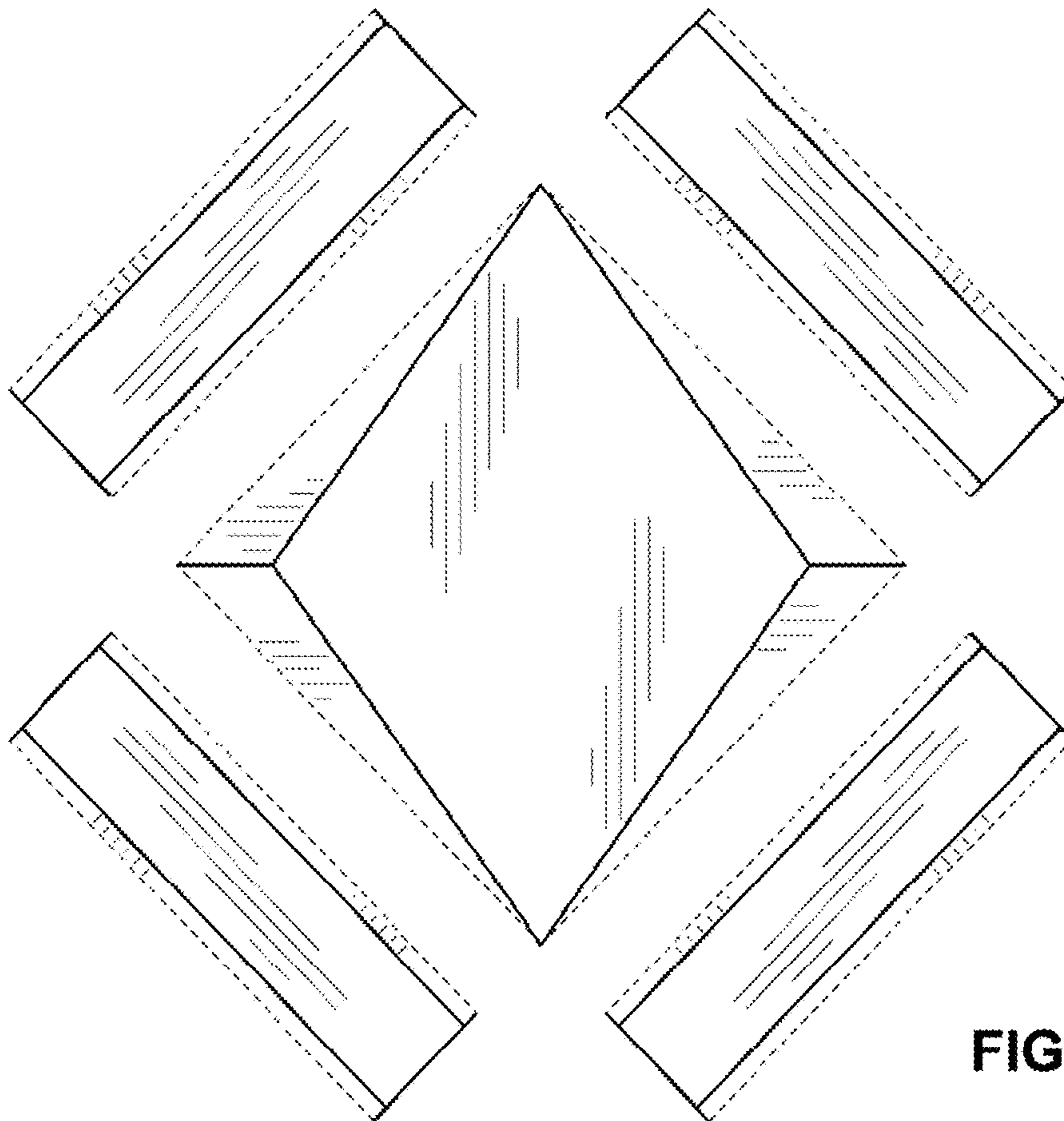
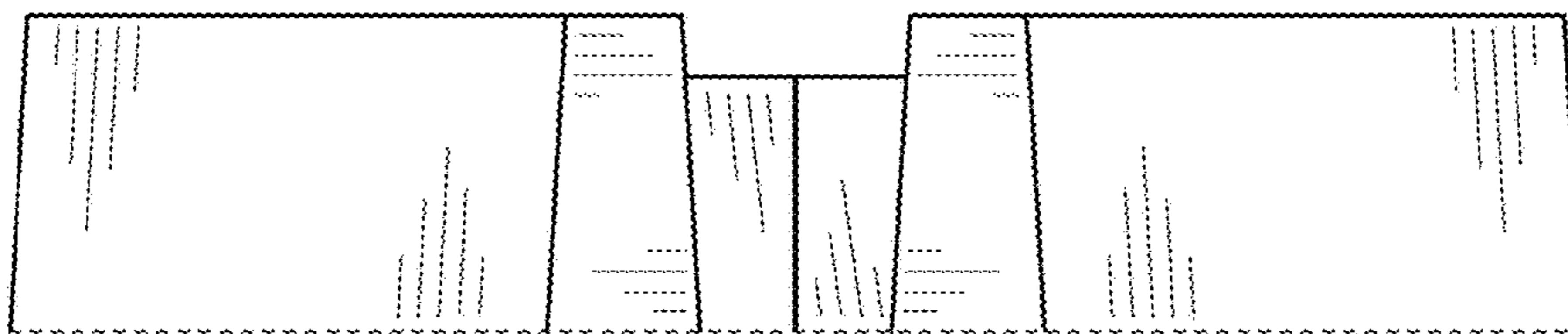
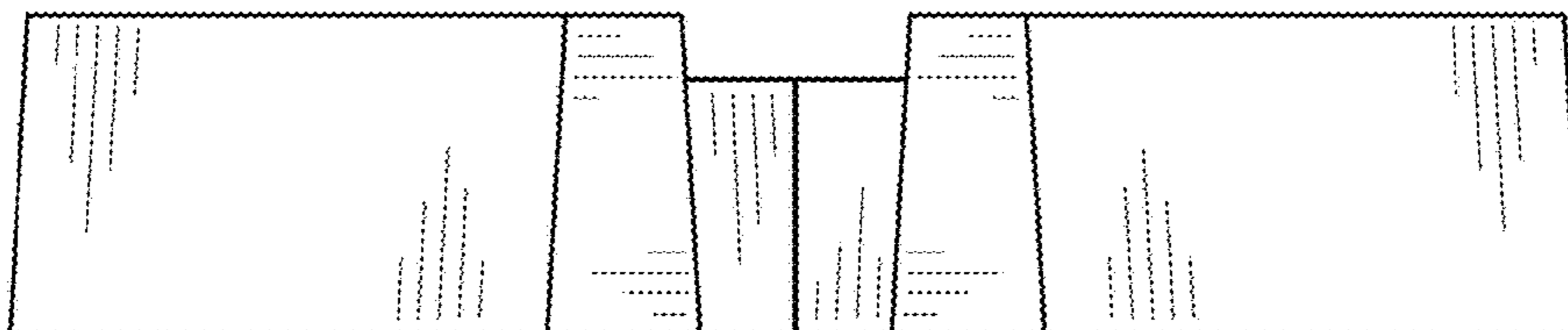

FIG. 14



**FIG. 15**



**FIG. 16**

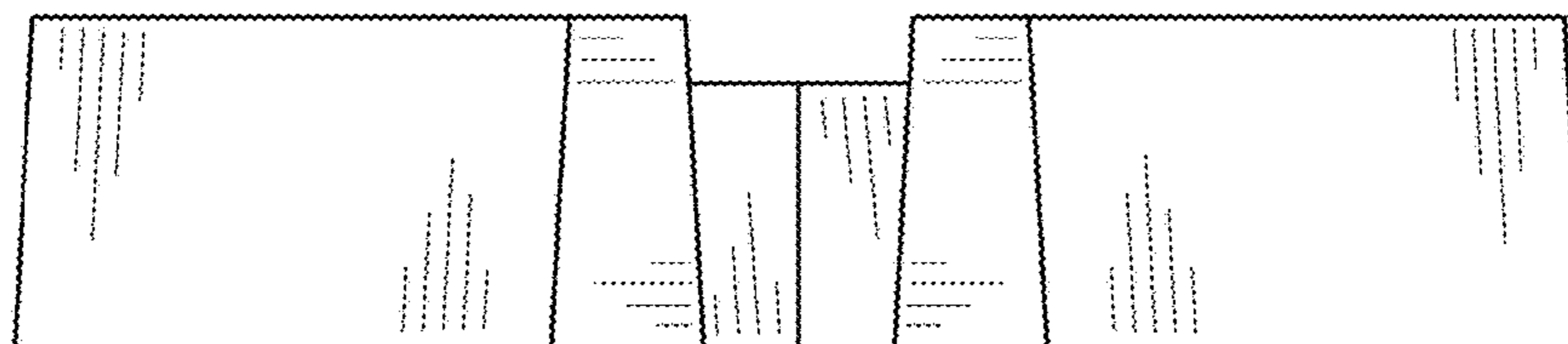

**FIG. 17**

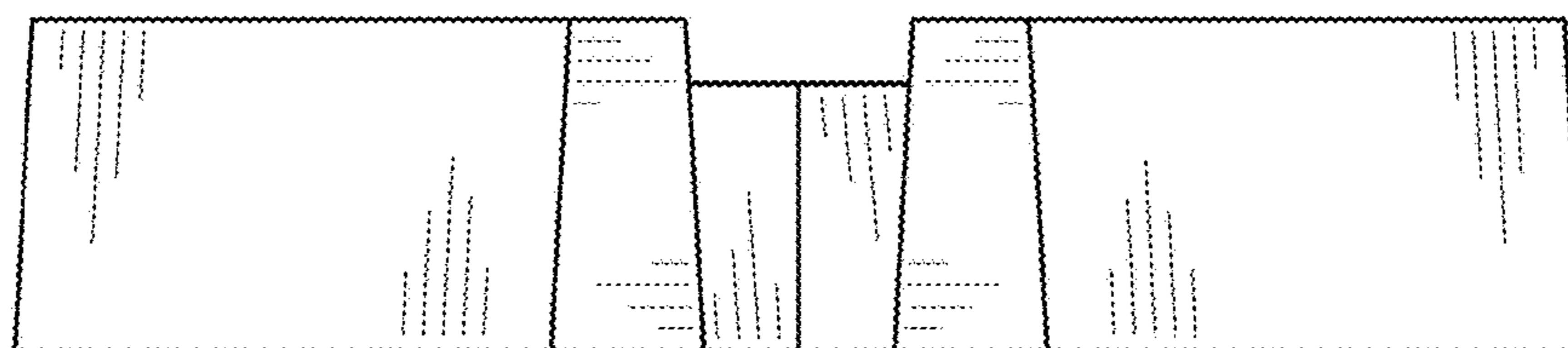

**FIG. 18**



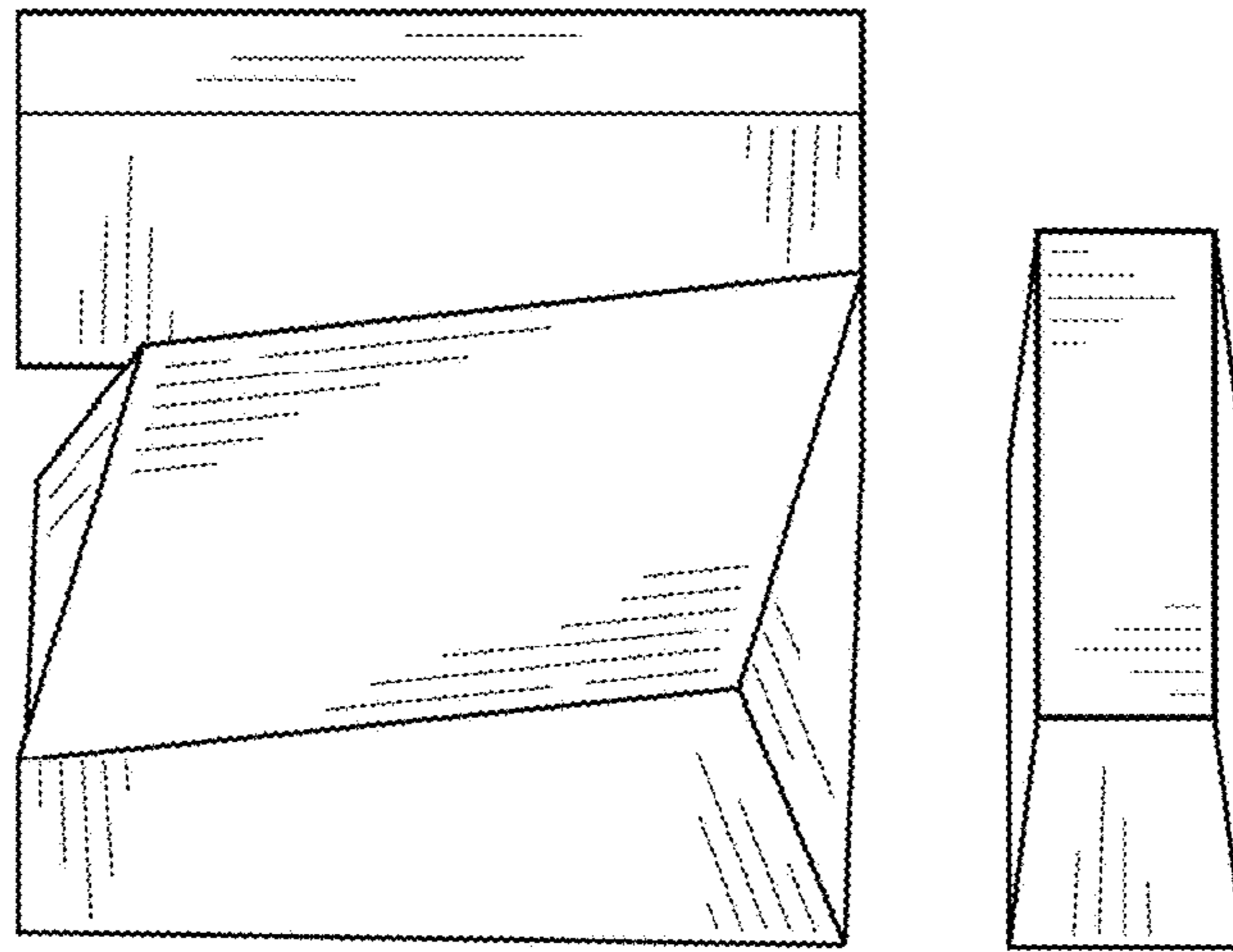

FIG. 19

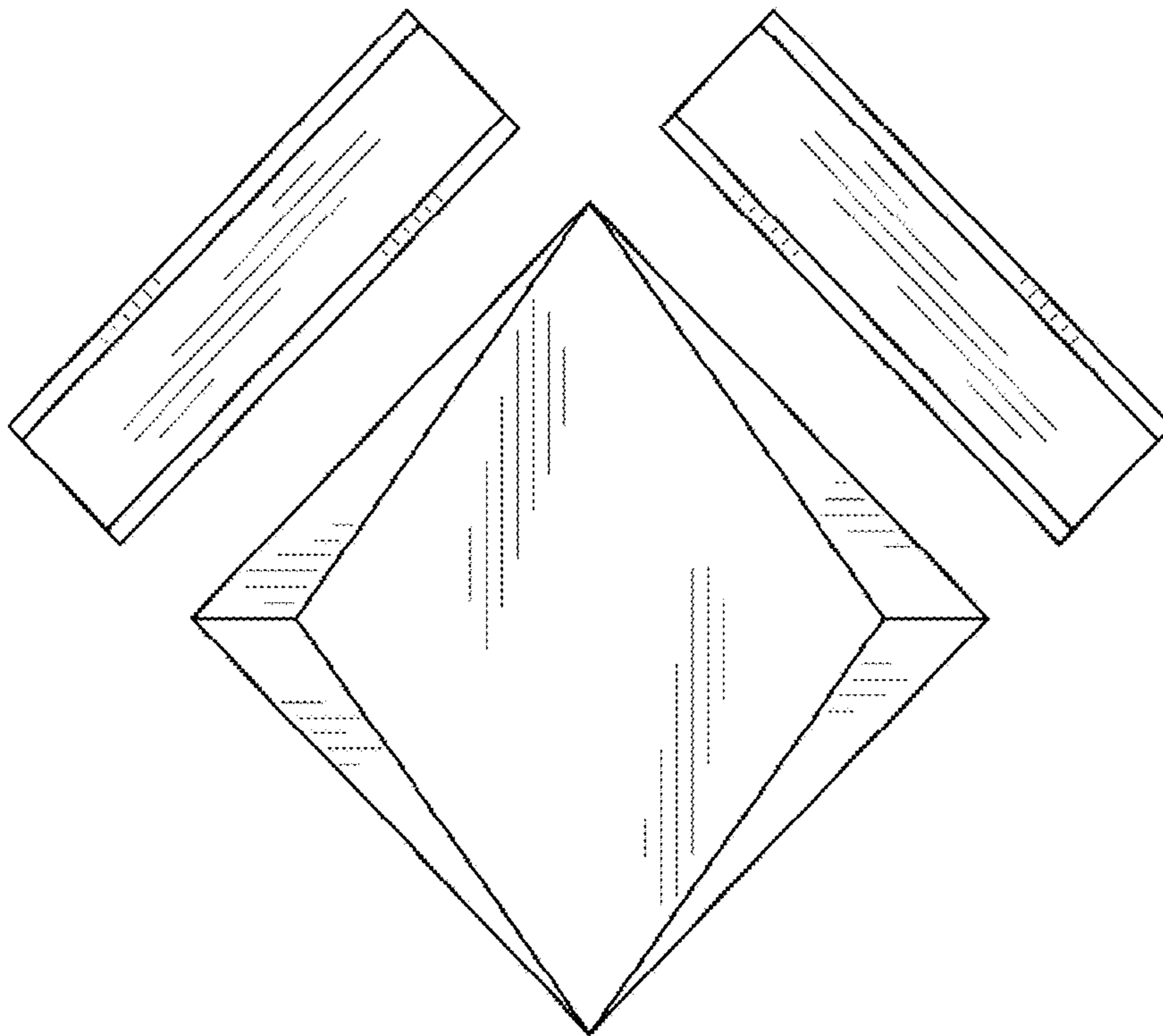

FIG. 20

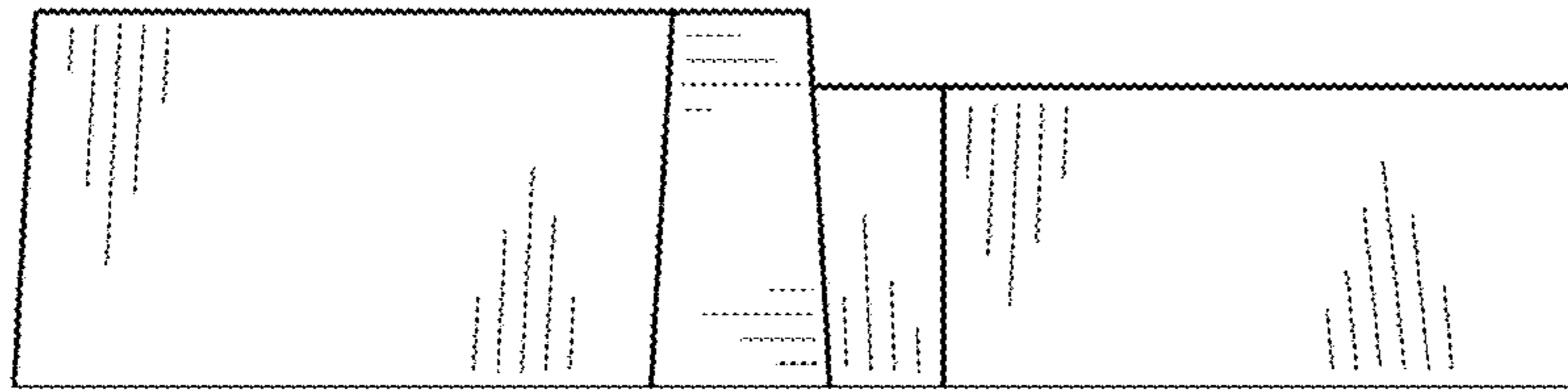

FIG. 21

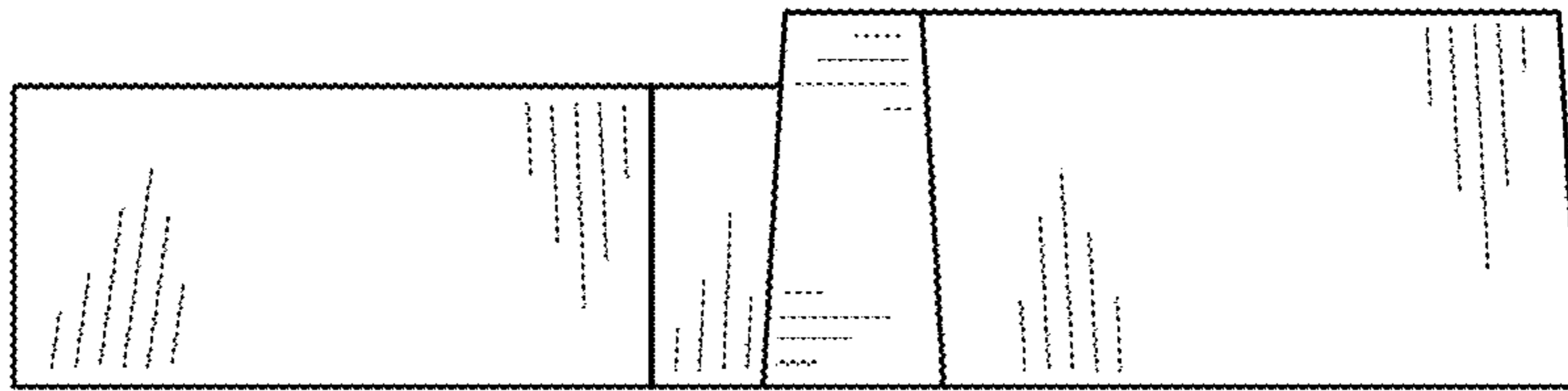

FIG. 22

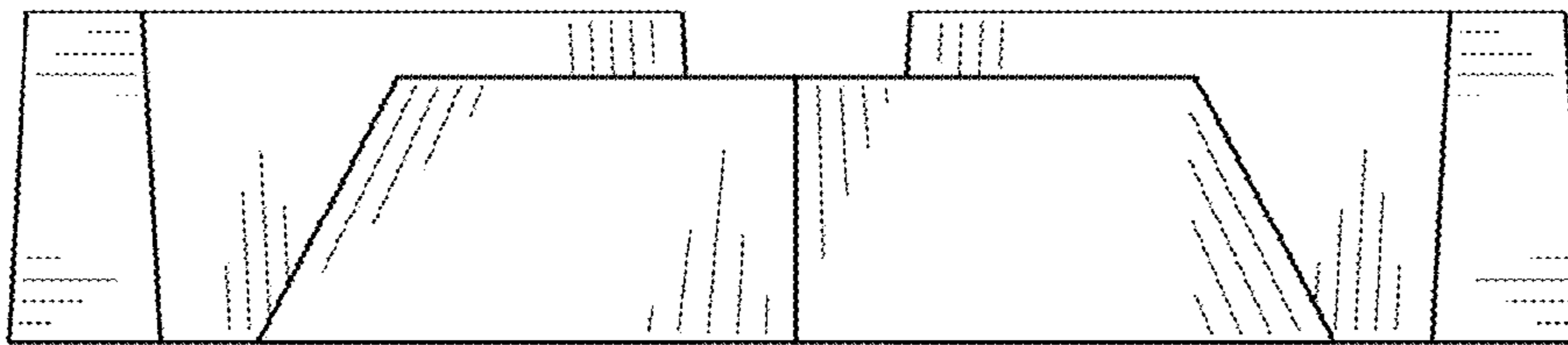

FIG. 23

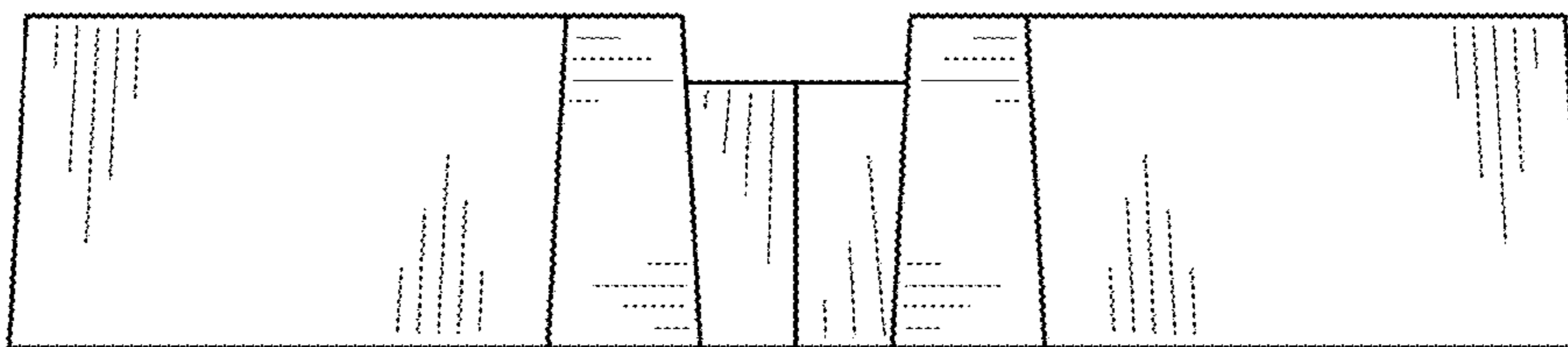

FIG. 24

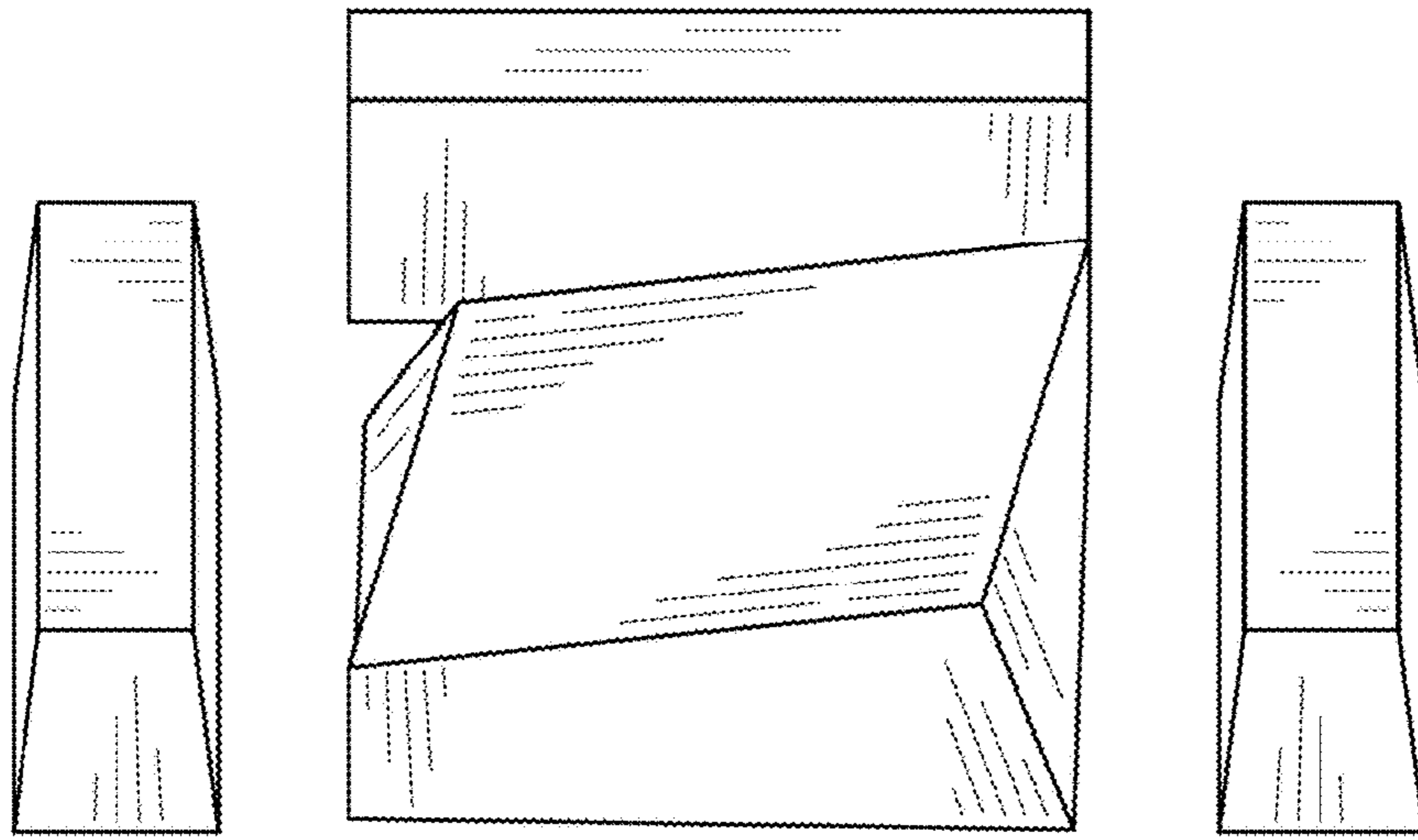

FIG. 25

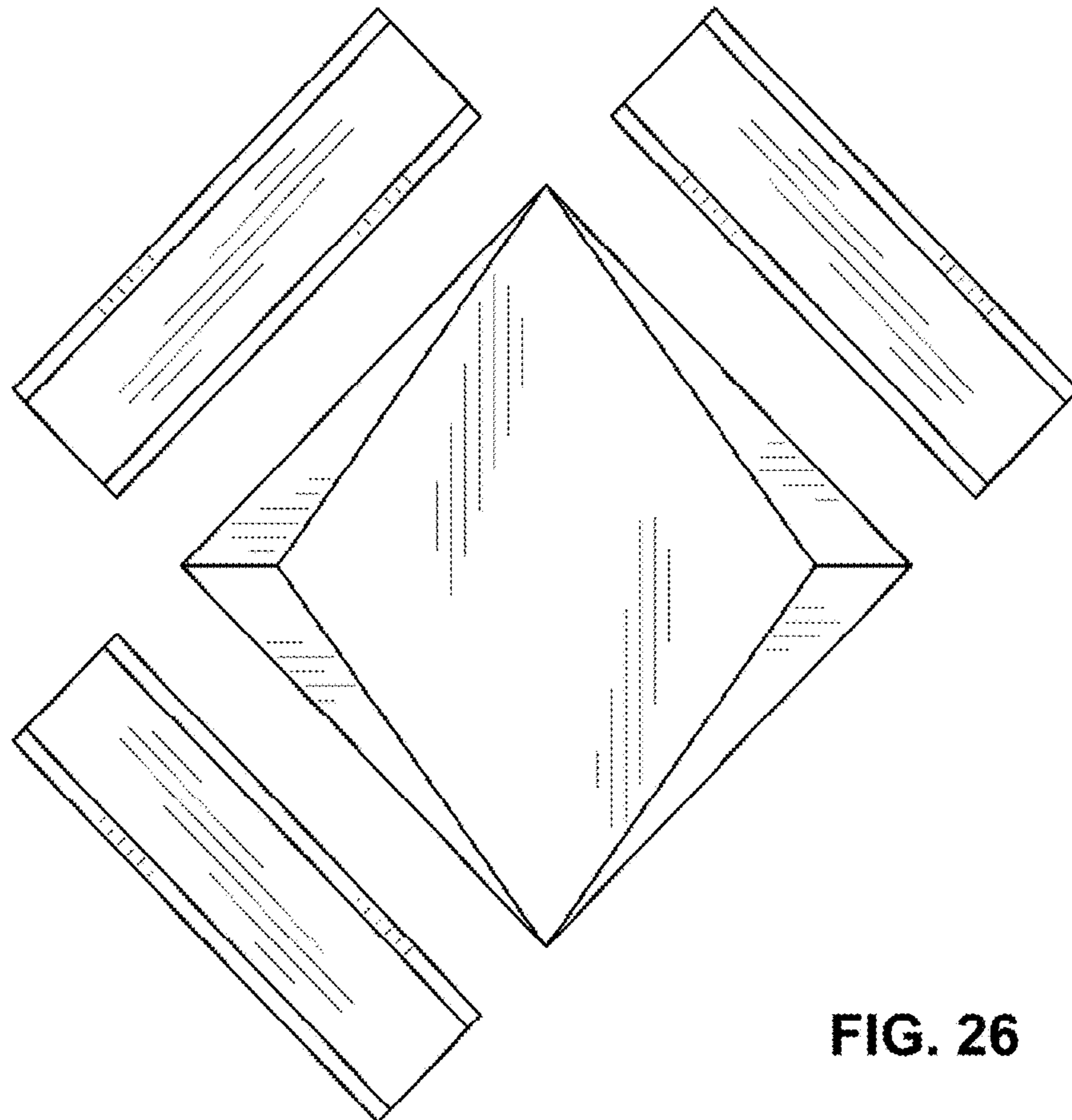

FIG. 26

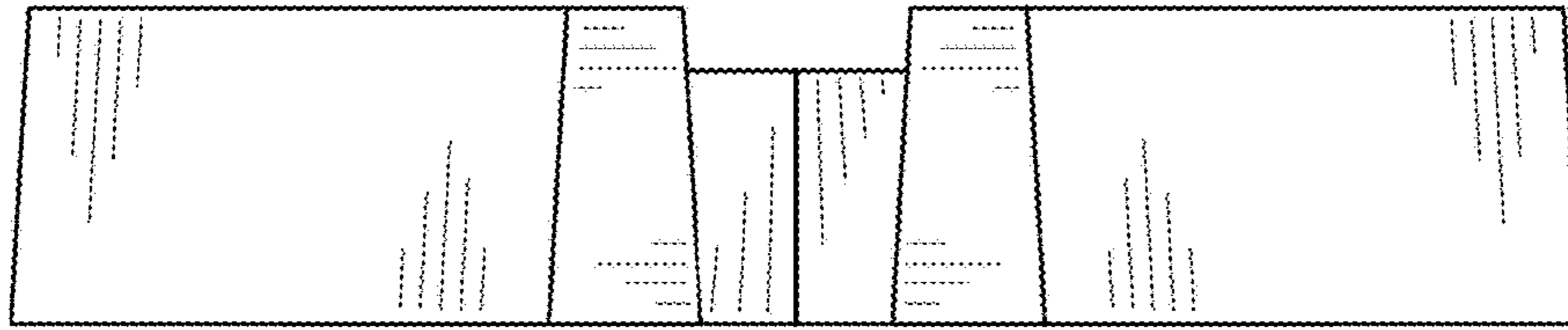

FIG. 27

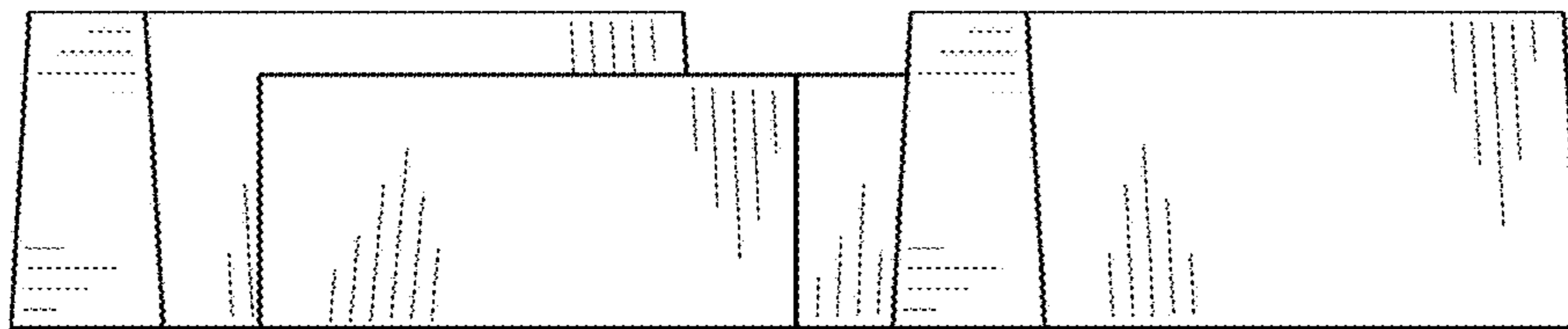

FIG. 28

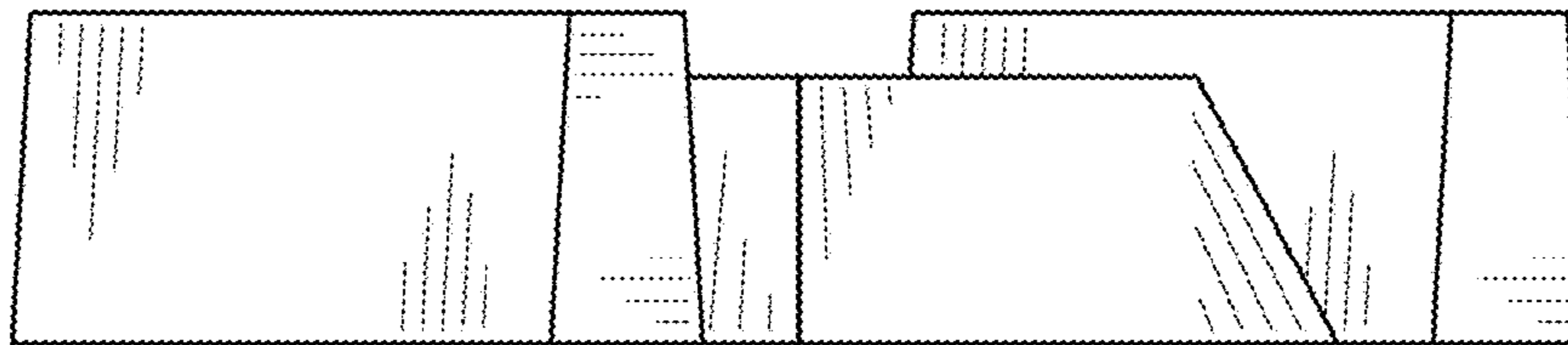

FIG. 29

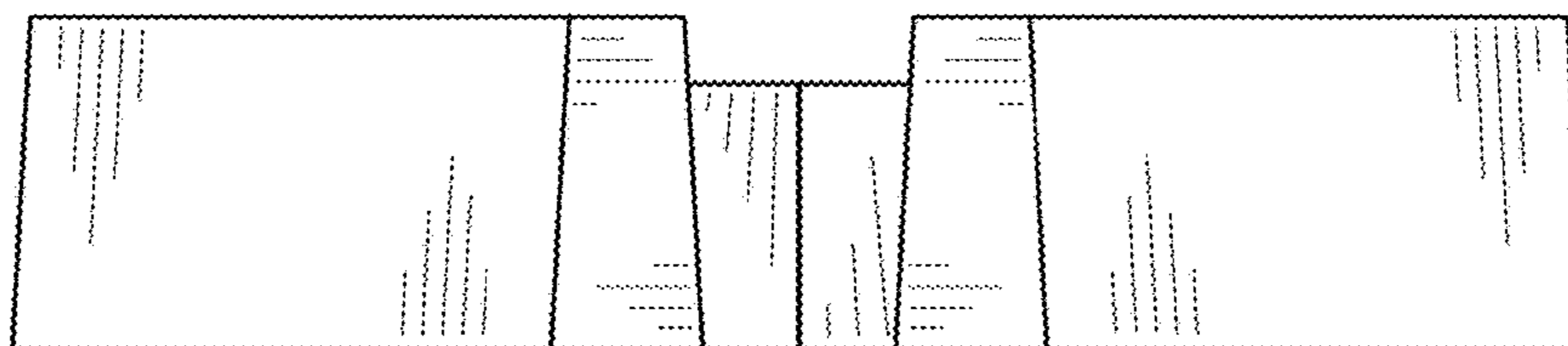

FIG. 30

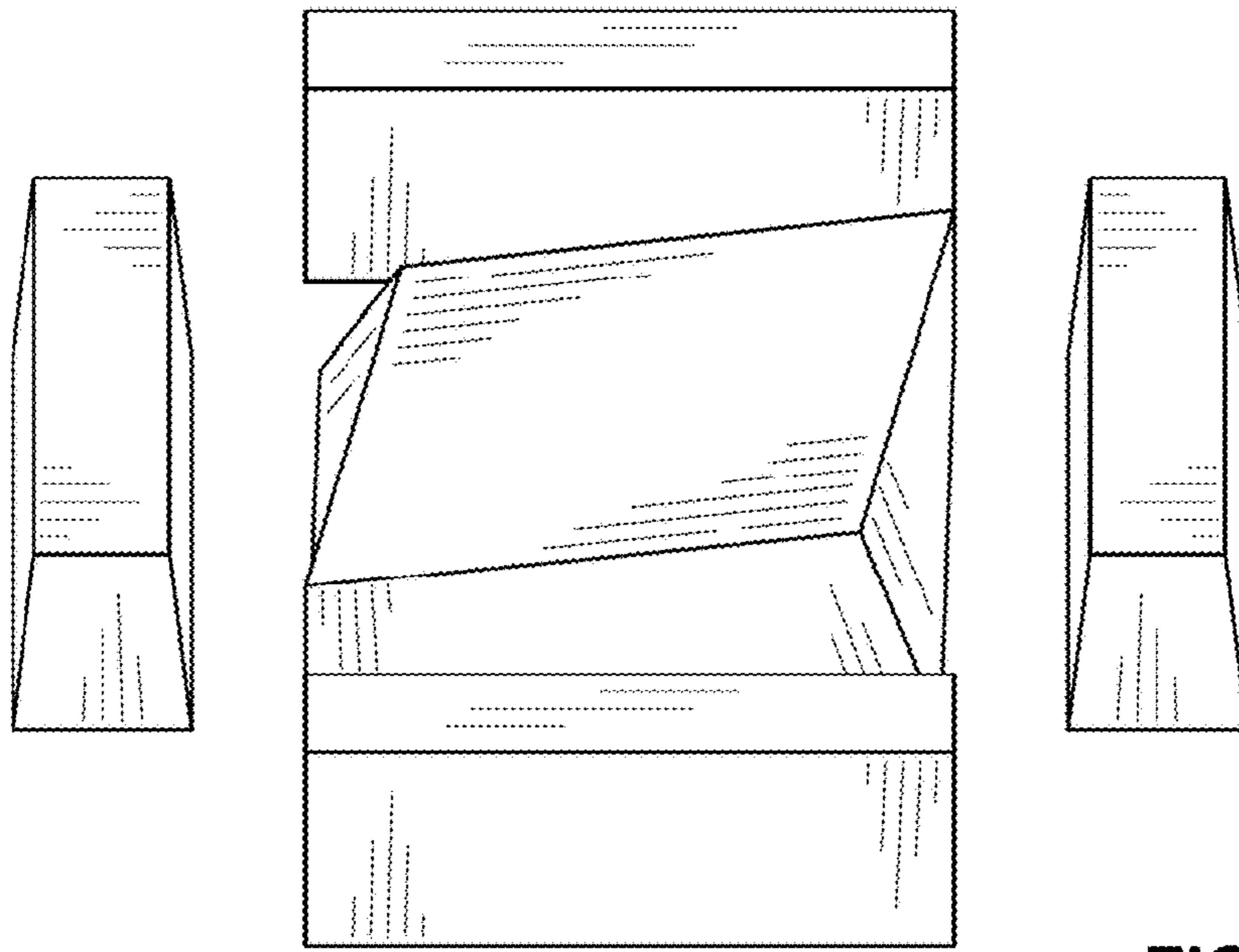

FIG. 31

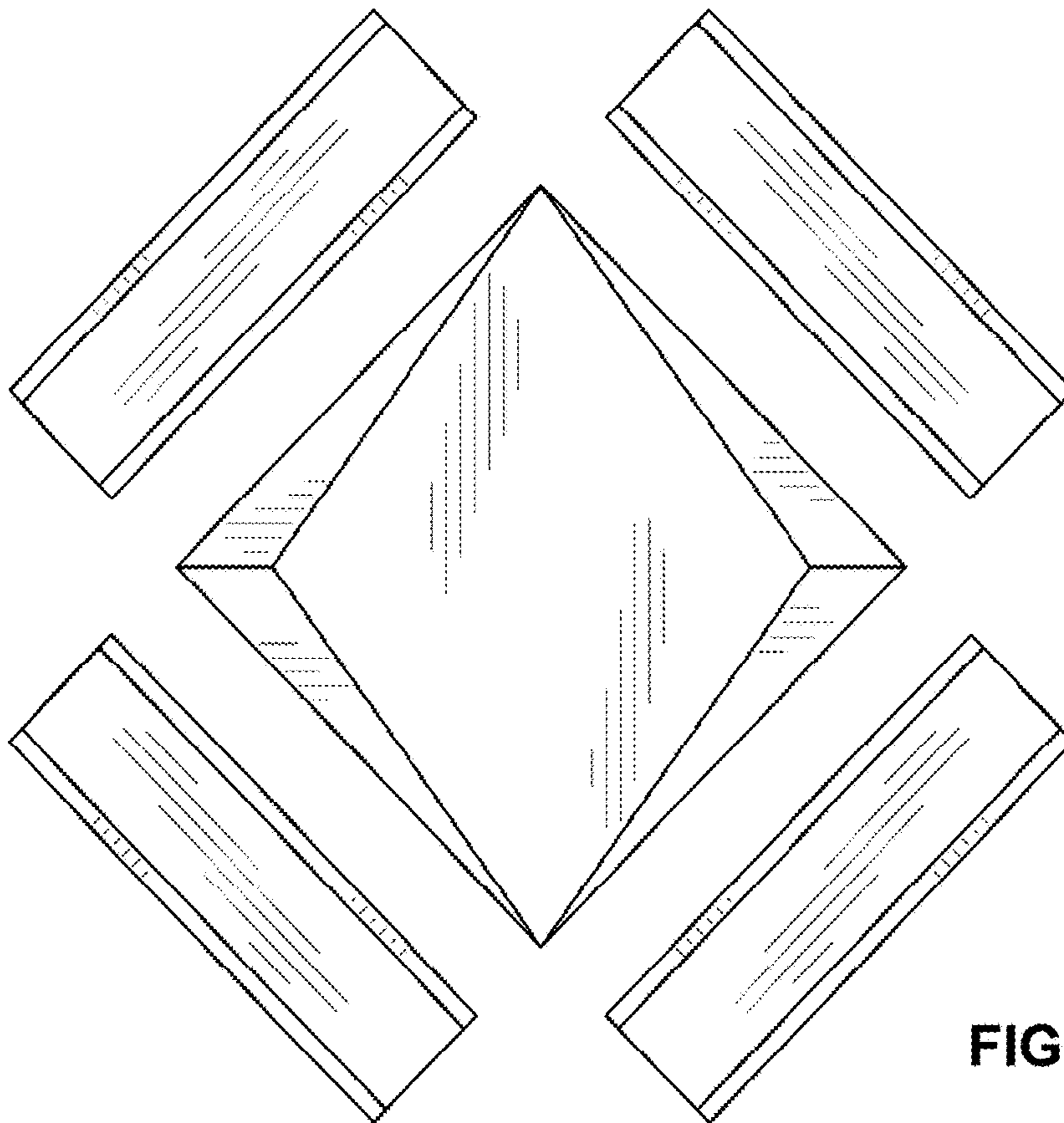

FIG. 32

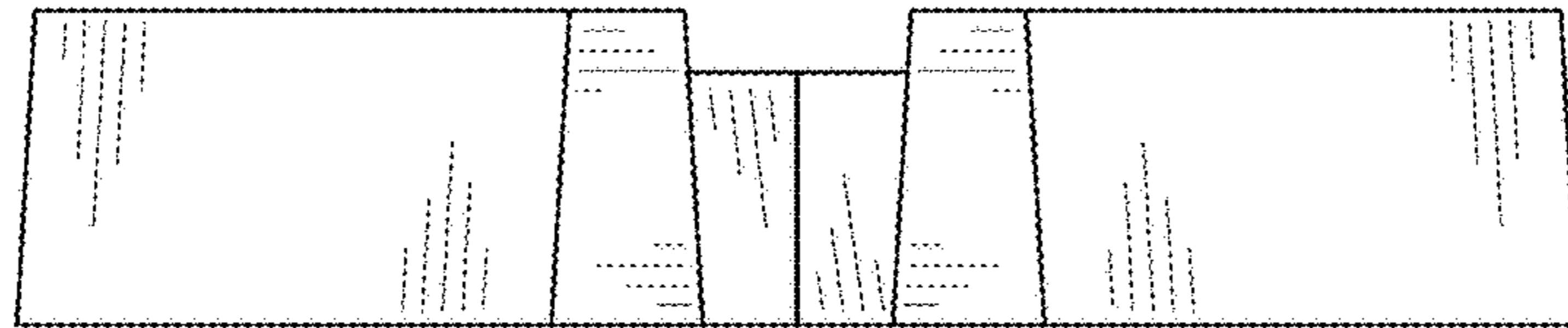

FIG. 33

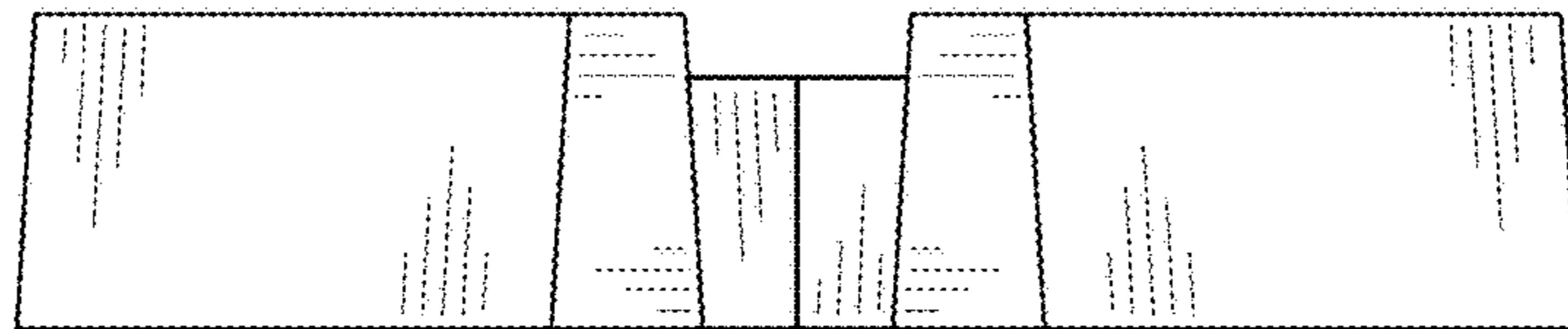

FIG. 34

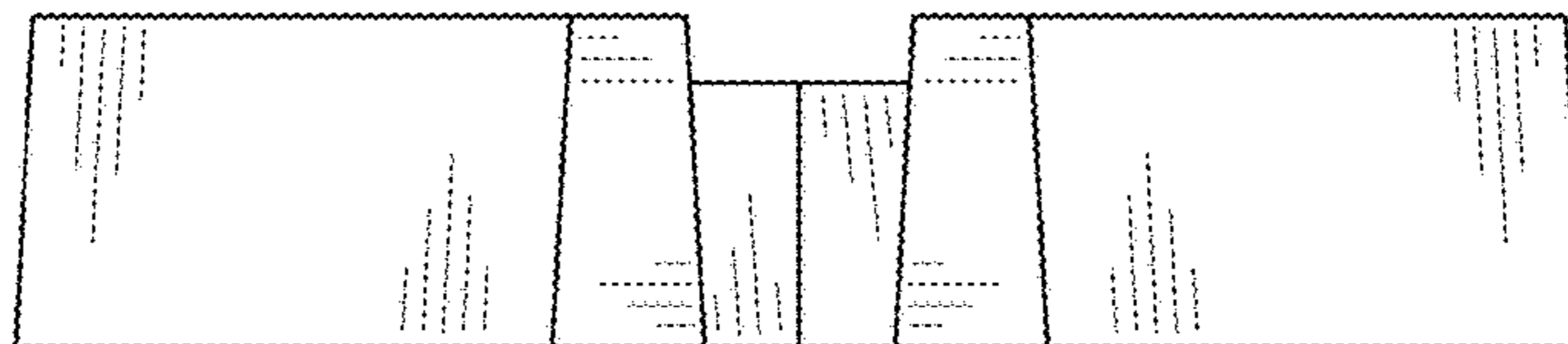

FIG. 35

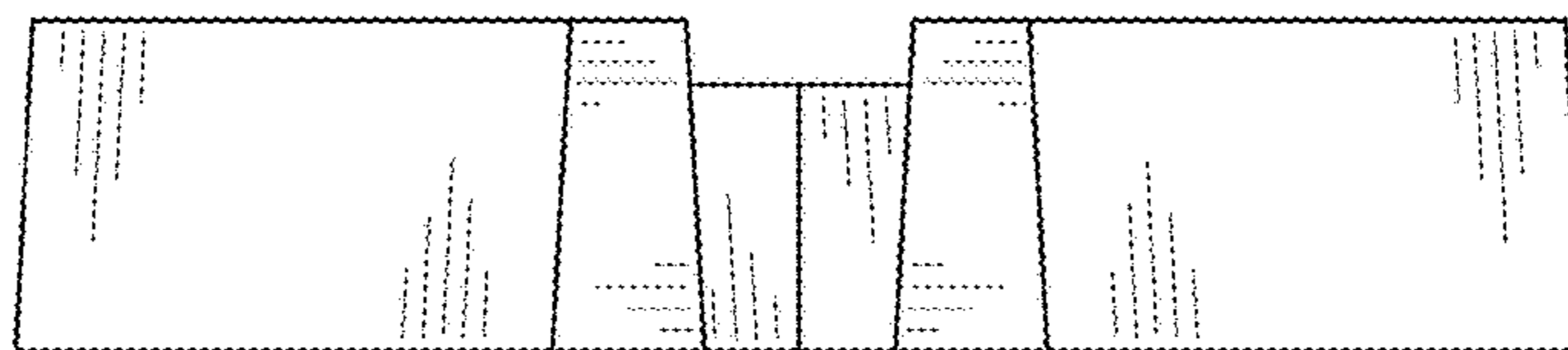

FIG. 36