



US00D803468S

(12) **United States Design Patent**  
**Pomputius**

(10) **Patent No.:** **US D803,468 S**

(45) **Date of Patent:** **\*\* Nov. 21, 2017**

(54) **FLOOR LAMP**

(71) Applicant: **John Pomp Studios, Inc.**, Philadelphia, PA (US)

(72) Inventor: **John Pomputius**, Philadelphia, PA (US)

(73) Assignee: **John Pomp Studios, Inc.**, Philadelphia, PA (US)

(\*\*) Term: **15 Years**

(21) Appl. No.: **29/562,481**

(22) Filed: **Apr. 26, 2016**

(51) **LOC (10) Cl.** ..... **26-03**

(52) **U.S. Cl.**  
USPC ..... **D26/107**

(58) **Field of Classification Search**

USPC ..... D26/24, 61-67, 93, 102, 104-109  
CPC .... F21S 8/08; F21S 6/002; F21V 1/00; F21V 21/02; F21V 21/084; F21V 21/14; F21W 2131/30

See application file for complete search history.

(56) **References Cited**

U.S. PATENT DOCUMENTS

4,453,204	A *	6/1984	Warshawsky	.....	F21S 6/002 248/296.1
D391,003	S *	2/1998	Porter	.....	D26/107
D401,004	S *	11/1998	Eusterbrock	.....	D26/107
D429,833	S *	8/2000	Lin	.....	D26/107
D467,680	S *	12/2002	Krieger	.....	D26/107
D652,563	S *	1/2012	Jensen	.....	D26/93
D654,202	S *	2/2012	Chen	.....	D26/107
D752,271	S *	3/2016	Saunders	.....	D26/107

\* cited by examiner

*Primary Examiner* — Brian N Vinson

(74) *Attorney, Agent, or Firm* — Gottlieb, Rackman & Reisman, P.C.

(57) **CLAIM**

The ornamental design for a floor lamp, as shown and described.

**DESCRIPTION**

FIG. 1 is a perspective view of the floor lamp showing my new design;

FIG. 2 is a front elevational view thereof;

FIG. 3 is a rear elevational view thereof;

FIG. 4 is a right side elevational view thereof;

FIG. 5 is a left side elevational view thereof;

FIG. 6 is a top plan view thereof;

FIG. 7 is a bottom plan view thereof;

FIG. 8 is an enlarged perspective view of the base of the floor lamp showing my new design.

FIG. 9 is a perspective view showing a second embodiment of my new design;

FIG. 10 is a front elevational view thereof;

FIG. 11 is a rear elevational view thereof;

FIG. 12 is a right side elevational view thereof;

FIG. 13 is a left side elevational view thereof;

FIG. 14 is a top plan view thereof;

FIG. 15 is a bottom plan view thereof; and,

FIG. 16 is an enlarged perspective view of the base of the floor lamp showing the second embodiment of my new design.

The broken lines in FIG. 1-FIG. 16 are for the purposes of illustrating environment only and form no part of the claimed design.

**1 Claim, 10 Drawing Sheets**

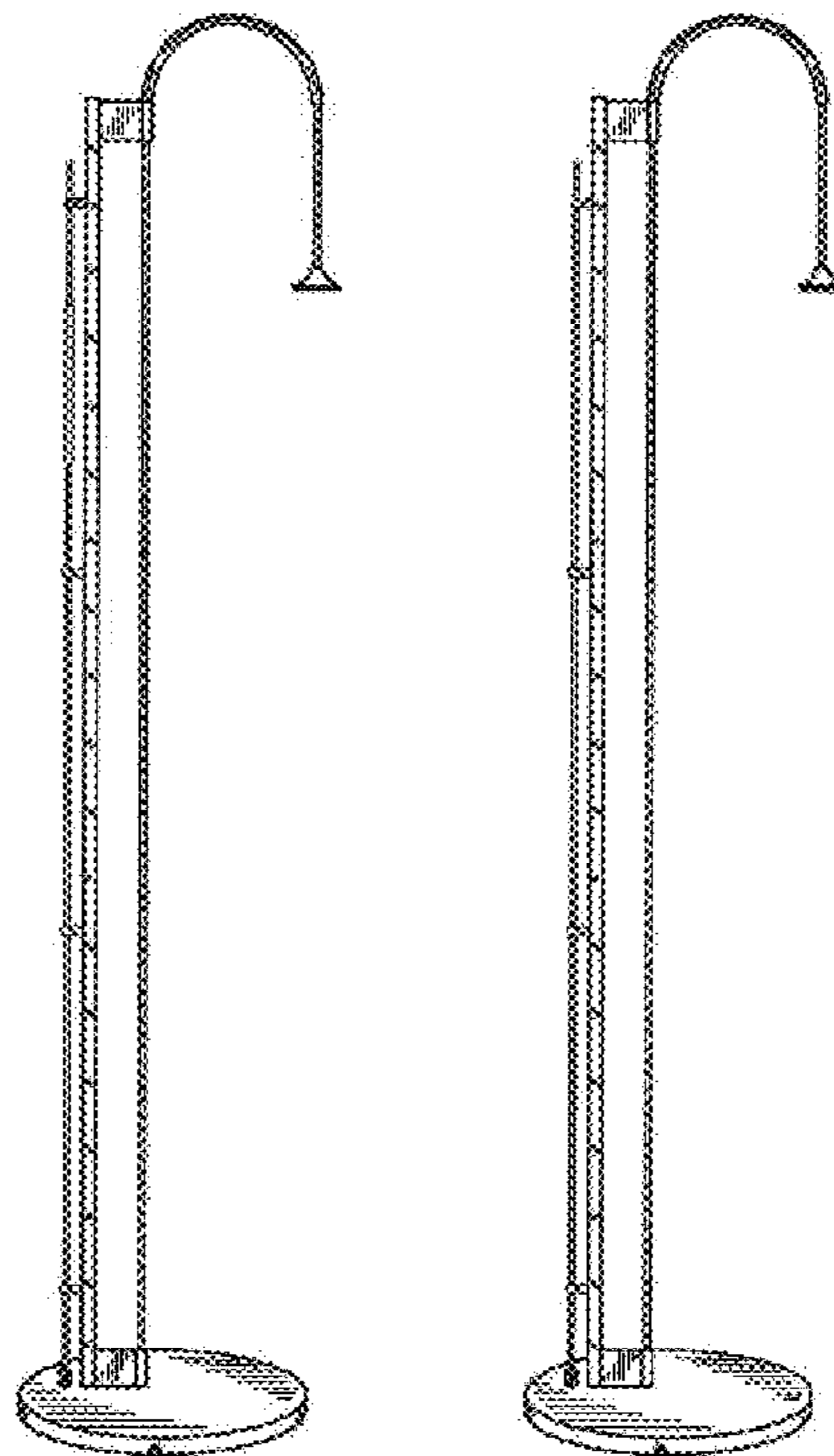

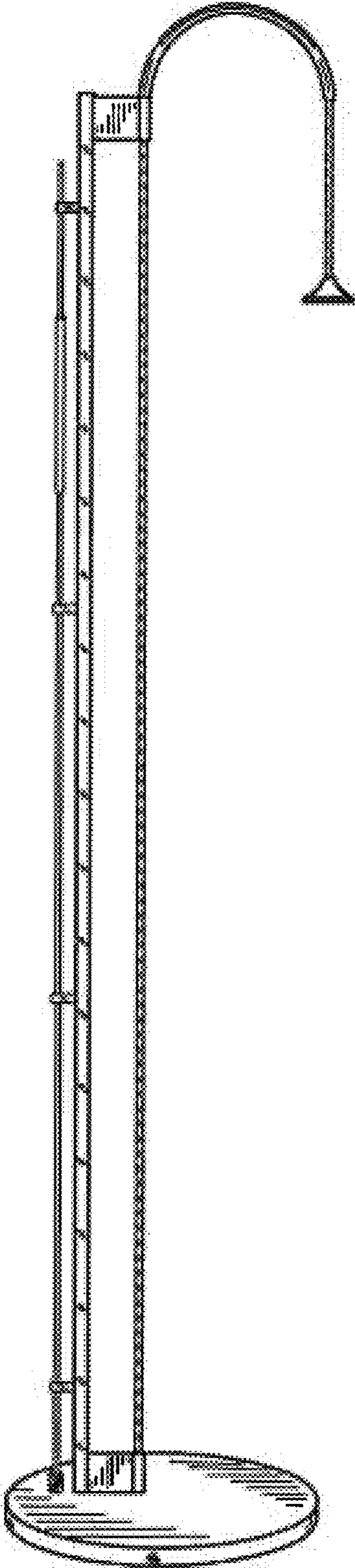

FIG. 1

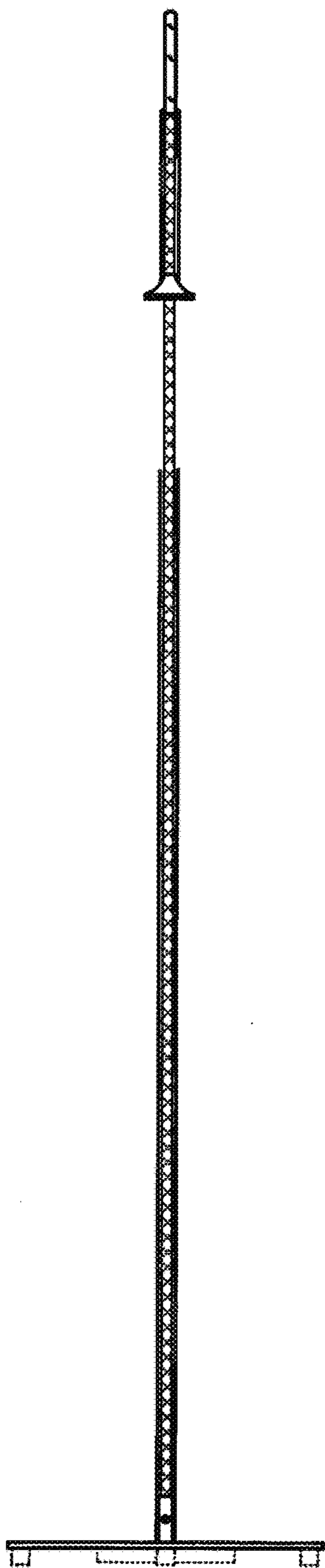

FIG. 2

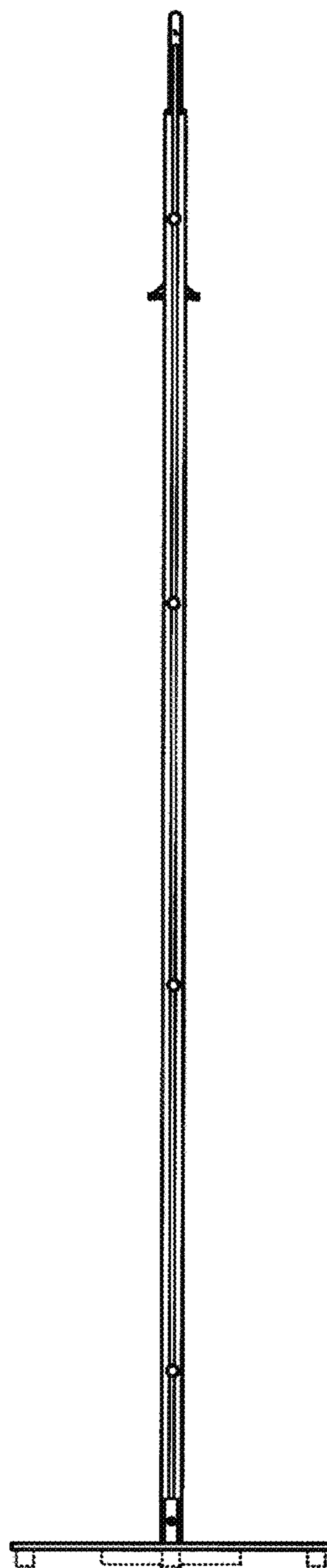

FIG. 3

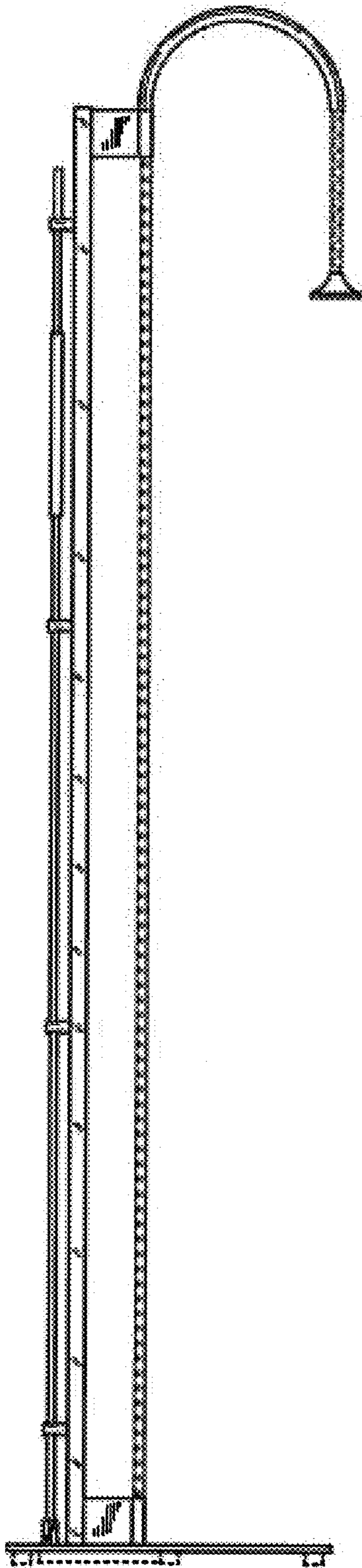

FIG. 4

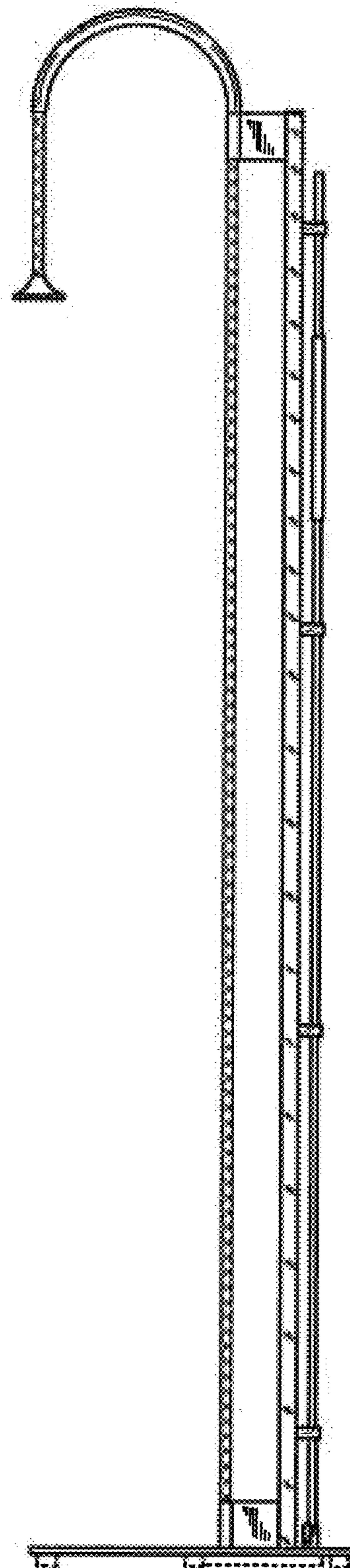

FIG. 5

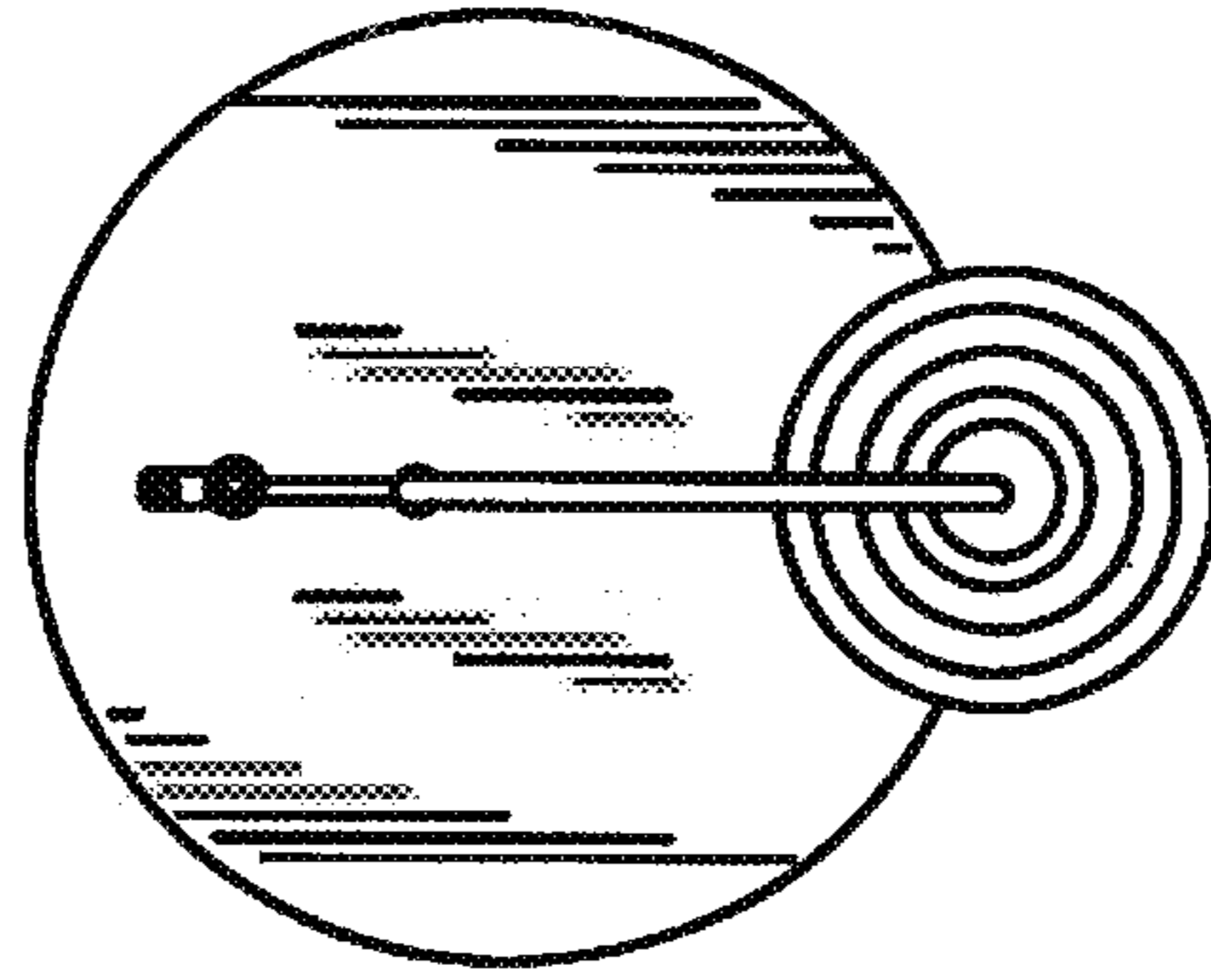

FIG. 6

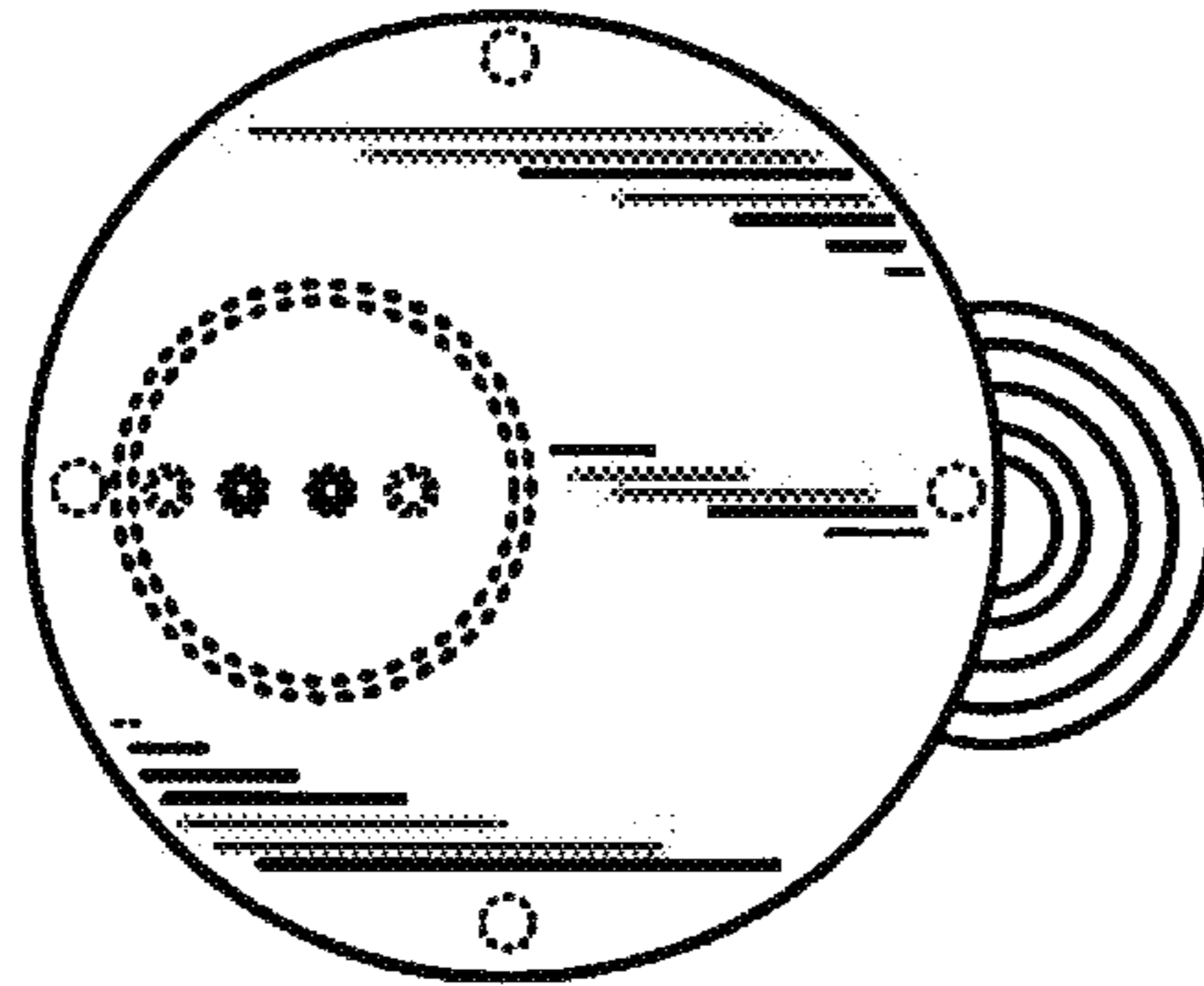

FIG. 7

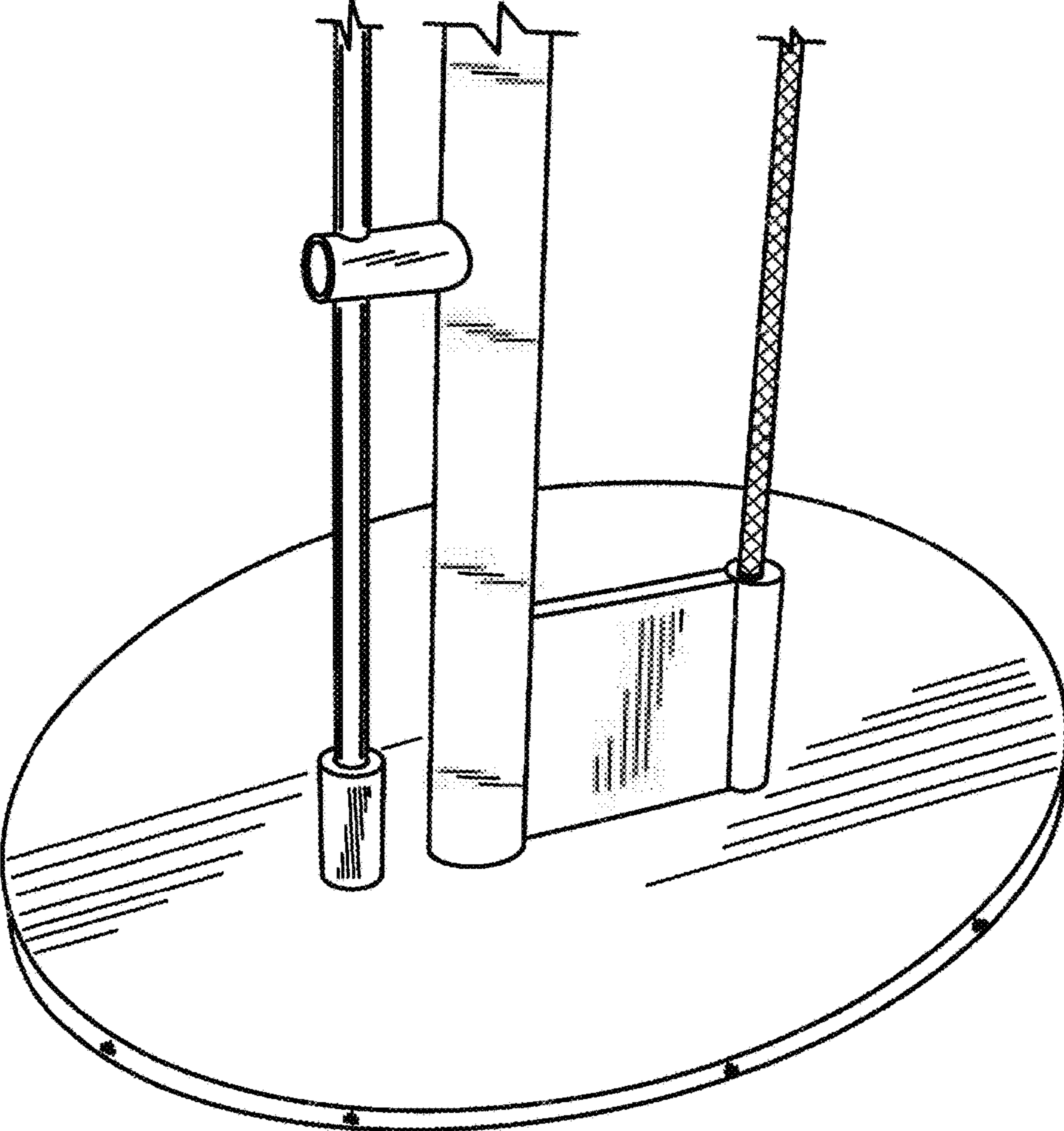

FIG. 8

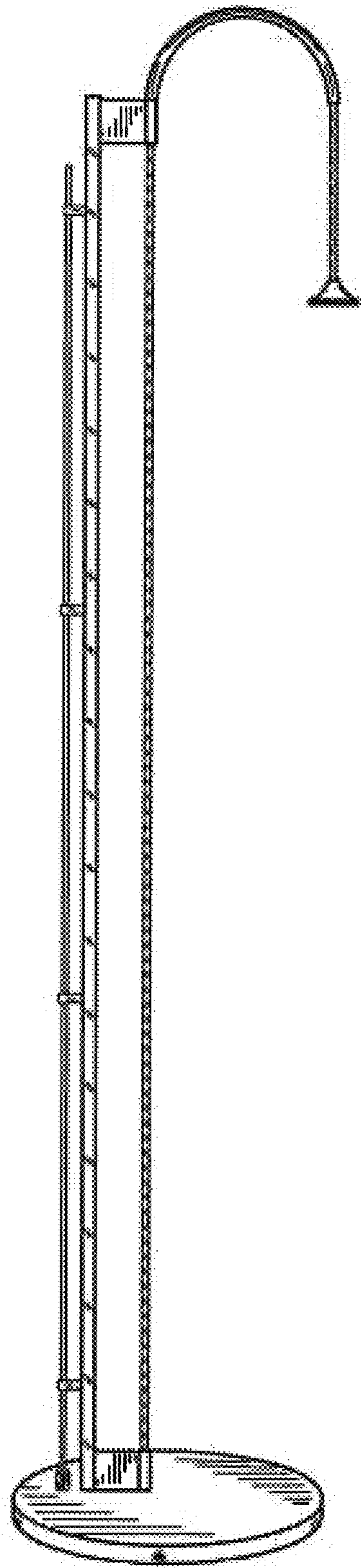

FIG. 9

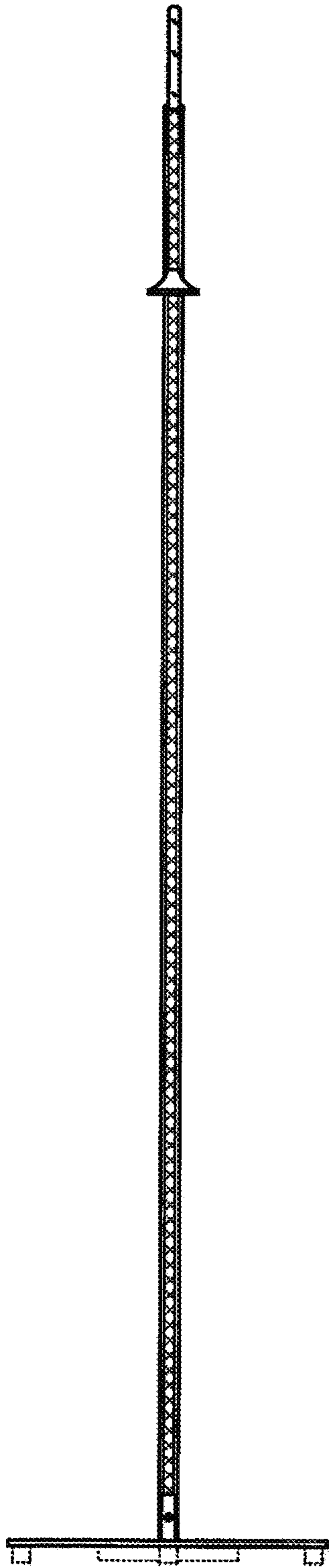

FIG. 10

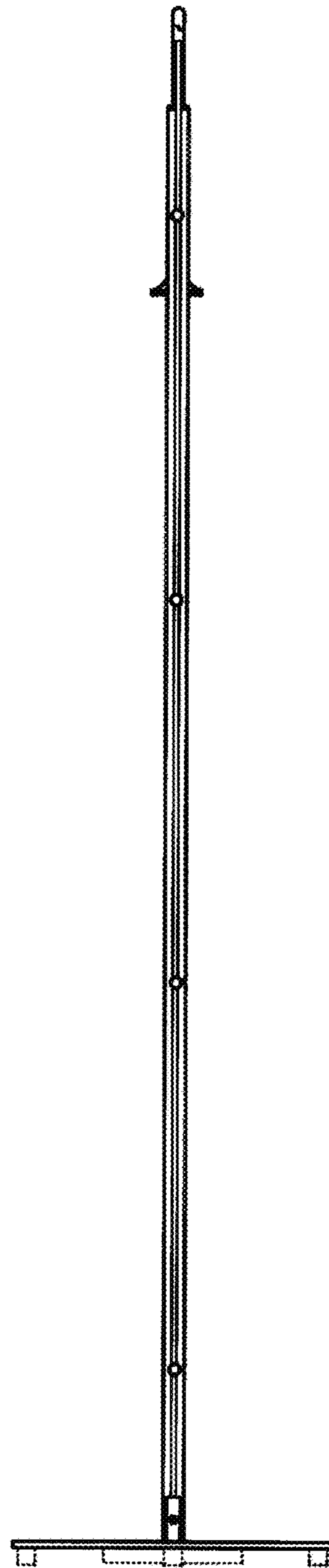

FIG. 11



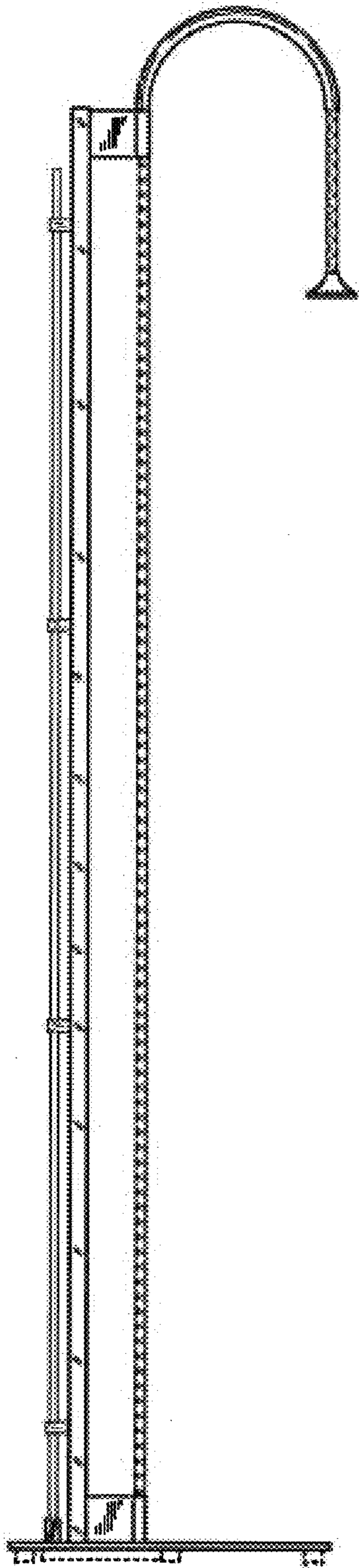

FIG. 12

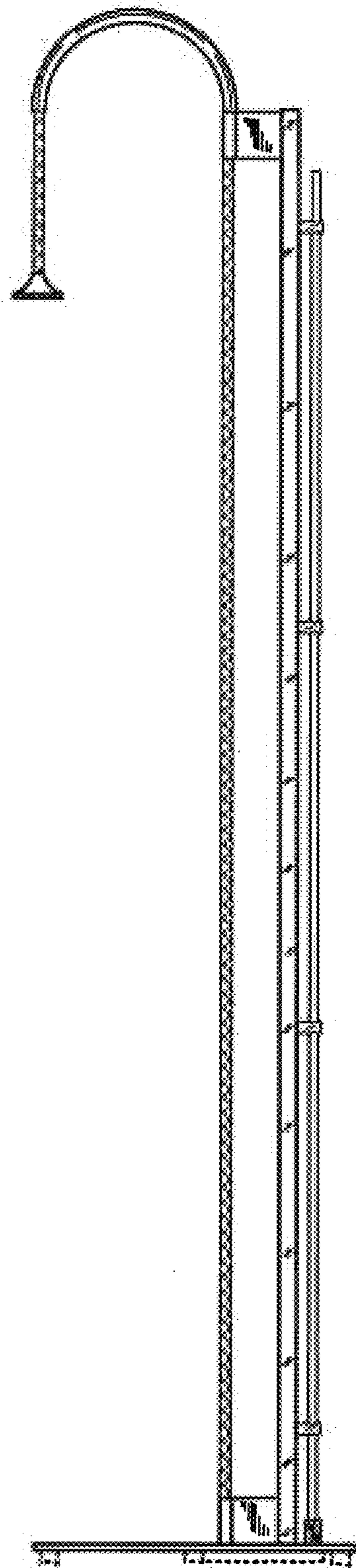

FIG. 13

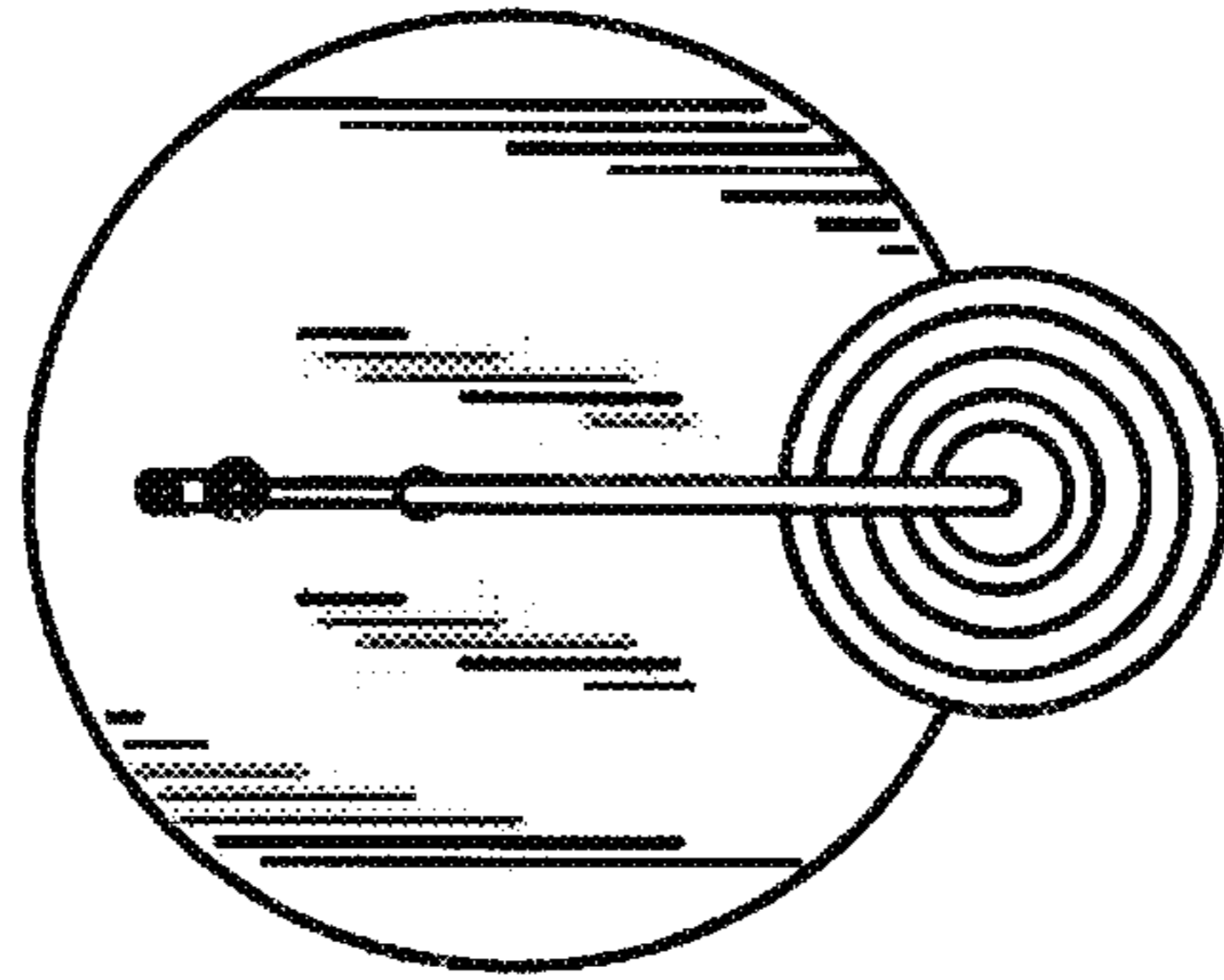

FIG. 14

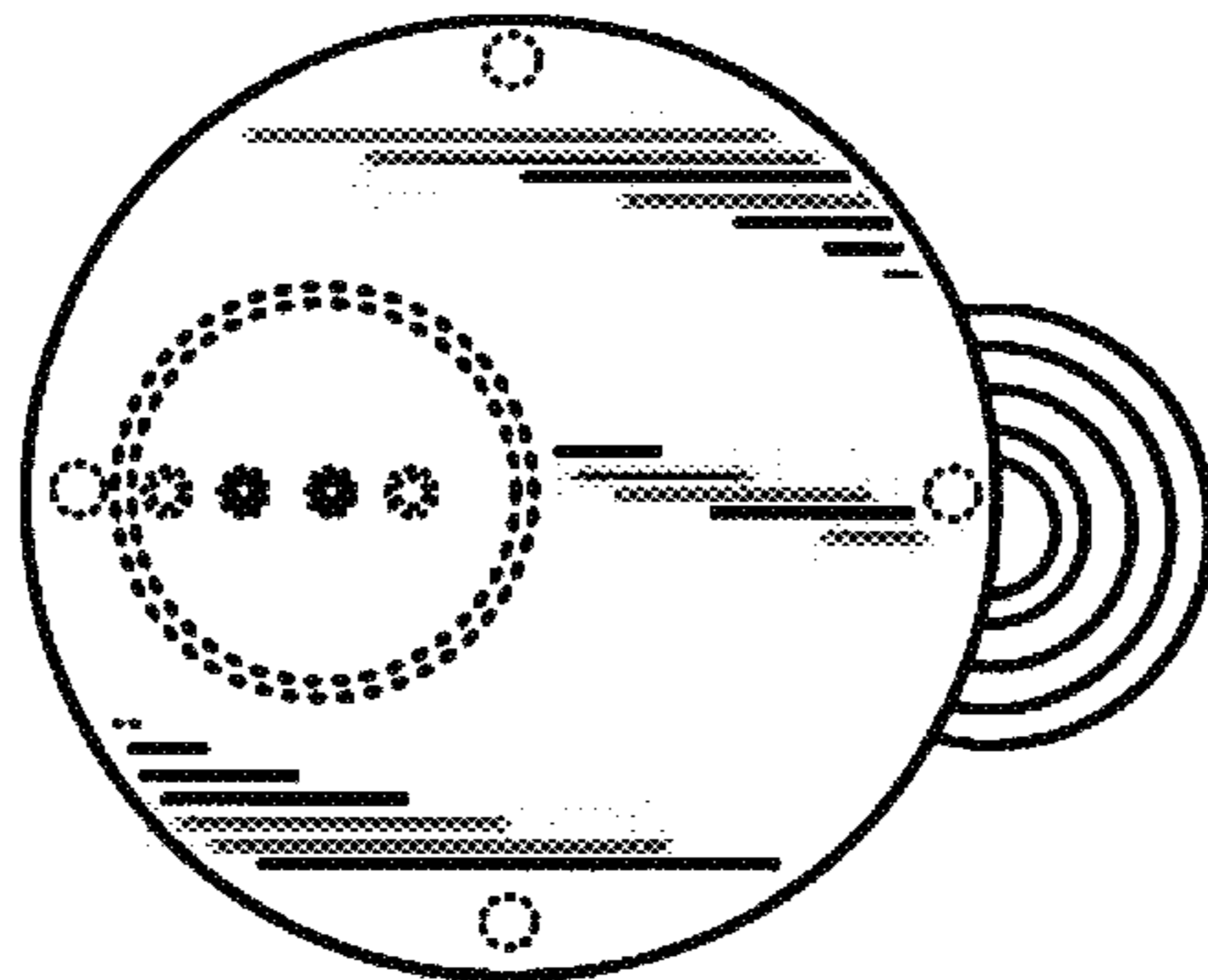

FIG. 15

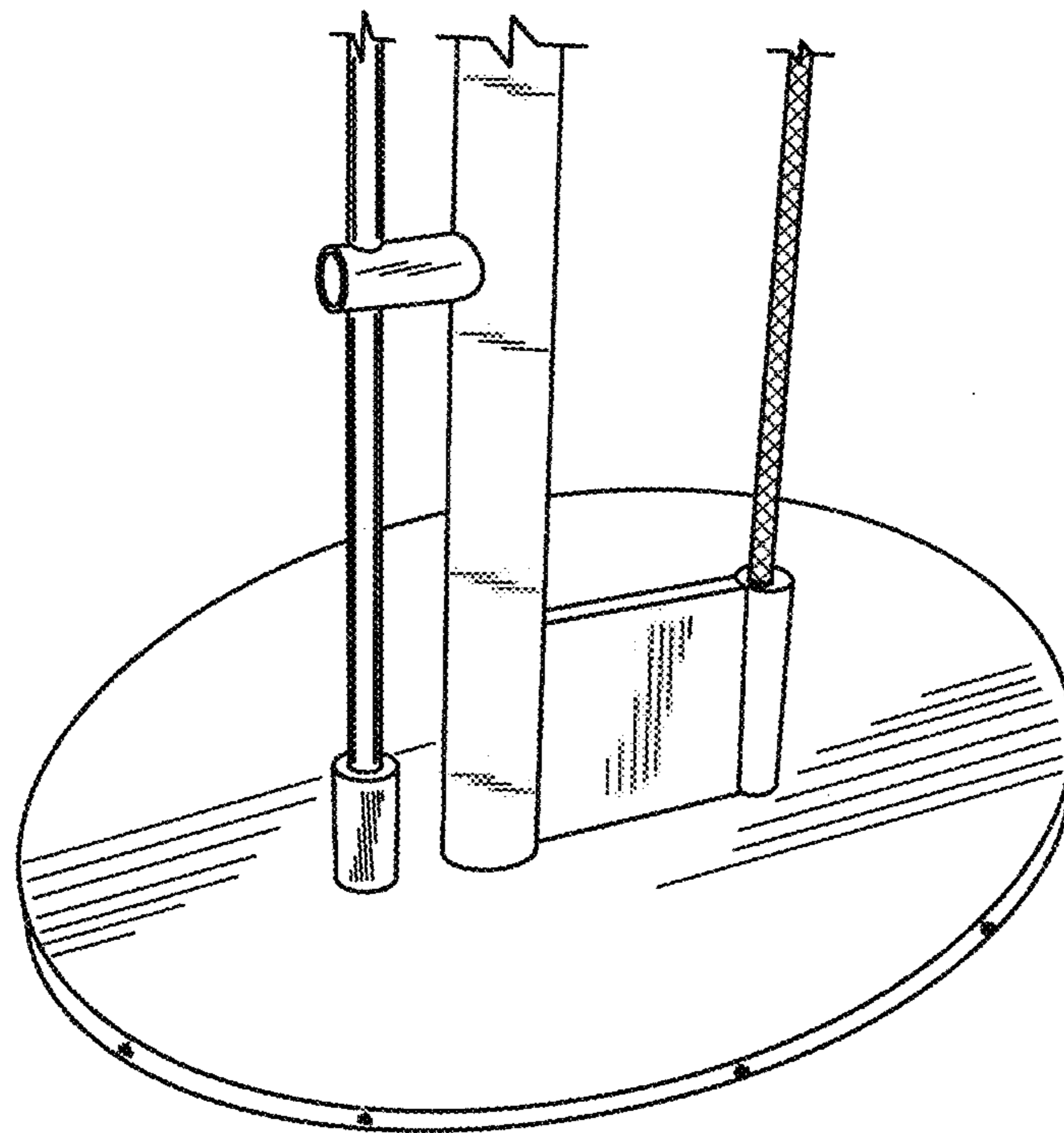

FIG. 16