



US00D803336S

(12) **United States Design Patent**  
**Kim et al.**

(10) **Patent No.:** **US D803,336 S**

(45) **Date of Patent:** **\*\* Nov. 21, 2017**

- (54) **GOLF CLUB HEAD**
- (71) Applicant: **Callaway Golf Company**, Carlsbad, CA (US)
- (72) Inventors: **Wee Joung Kim**, Vista, CA (US);  
**Brooks Roche**, Ramona, CA (US);  
**Randolph J. Peterson**, Carlsbad, CA (US); **Scott R. Manwaring**, Carlsbad, CA (US)
- (73) Assignee: **Callaway Golf Company**, Carlsbad, CA (US)
- (\*\*) Term: **15 Years**
- (21) Appl. No.: **29/576,224**
- (22) Filed: **Sep. 1, 2016**
- (51) **LOC (10) Cl.** ..... **21-02**
- (52) **U.S. Cl.**  
USPC ..... **D21/759**
- (58) **Field of Classification Search**  
USPC ..... D21/747-751, 759  
CPC ..... A63B 53/00; A63B 53/04; A63B 53/047;  
A63B 53/0475; A63B 2053/0479; A63B 2053/0483; A63B 2053/0445  
See application file for complete search history.

- D459,424 S \* 6/2002 Asplund ..... A63B 53/047  
D21/747
- 6,846,246 B2 \* 1/2005 Asplund ..... A63B 53/047  
473/327
- D518,863 S \* 4/2006 Motoyoshi ..... D21/747
- D521,583 S \* 5/2006 Motoyoshi ..... D21/747
- D751,660 S \* 3/2016 Greenlaw ..... D21/759
- D765,809 S \* 9/2016 Peterson ..... D21/759
- D766,388 S \* 9/2016 Wang ..... D21/747
- D767,057 S \* 9/2016 Mickelson ..... D21/747
- D779,007 S \* 2/2017 Oyler ..... D21/747
- D791,893 S \* 7/2017 Wang ..... D21/747

\* cited by examiner

*Primary Examiner* — Mitchell I. Siegel

(74) *Attorney, Agent, or Firm* — Rebecca Hanovice;  
Michael Catania; Sonia Lari

(57) **CLAIM**

The ornamental design for a golf club head, as shown and described.

**DESCRIPTION**

FIG. 1 is a rear perspective view of the golf club head claimed herein;  
 FIG. 2 is a front elevational view thereof;  
 FIG. 3 is a rear elevational view thereof;  
 FIG. 4 is a left side elevational view thereof;  
 FIG. 5 is a right side elevational view thereof;  
 FIG. 6 is a top plan view thereof; and,  
 FIG. 7 is a bottom plan view thereof.  
 The broken lines are included for the purpose of illustration and form no part of the claimed design.

(56) **References Cited**

**U.S. PATENT DOCUMENTS**

- D228,564 S \* 10/1973 Braly ..... D21/751
- D376,632 S \* 12/1996 Simmons ..... D21/750
- D419,214 S \* 1/2000 Hamm ..... D21/750

**1 Claim, 4 Drawing Sheets**

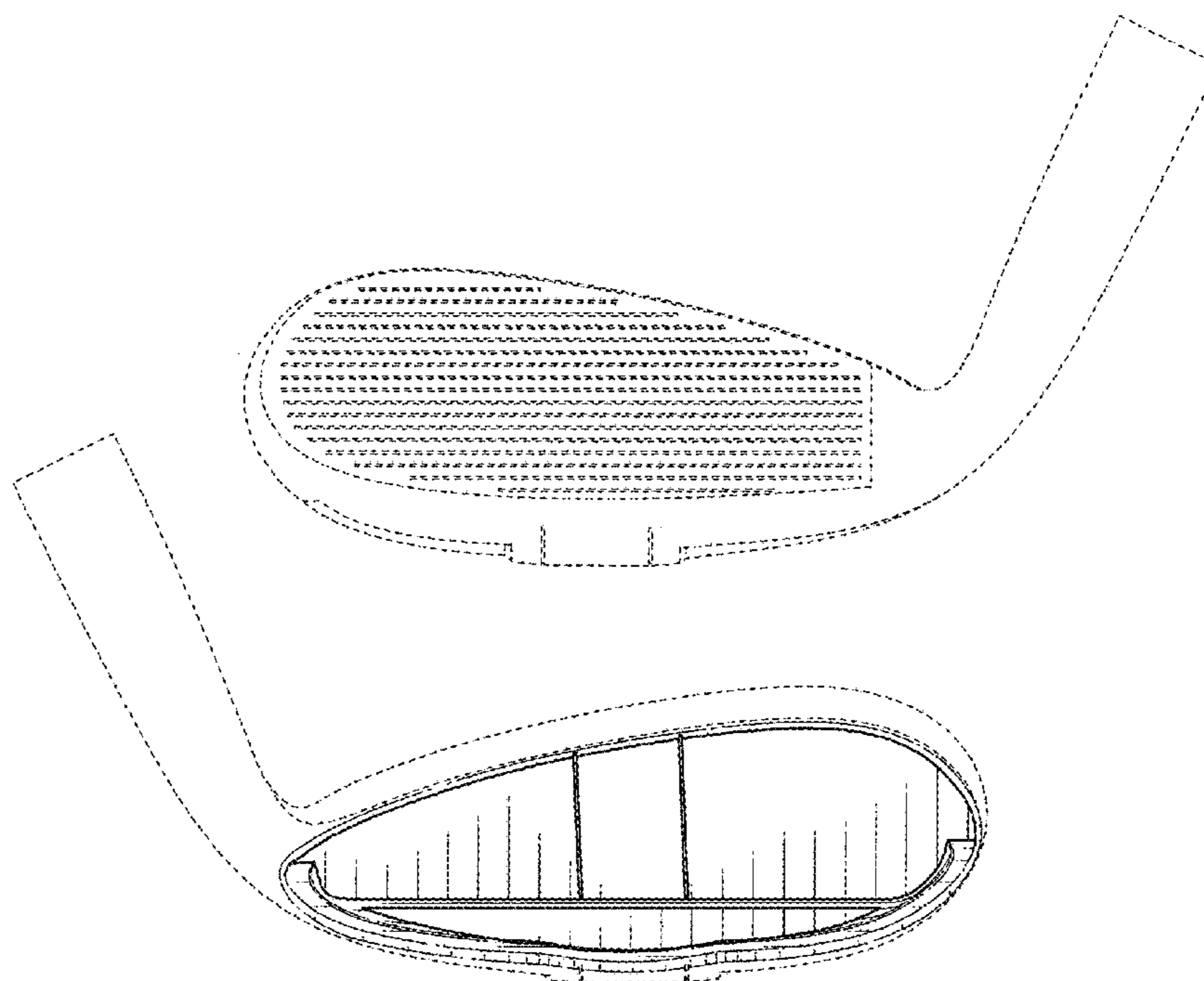

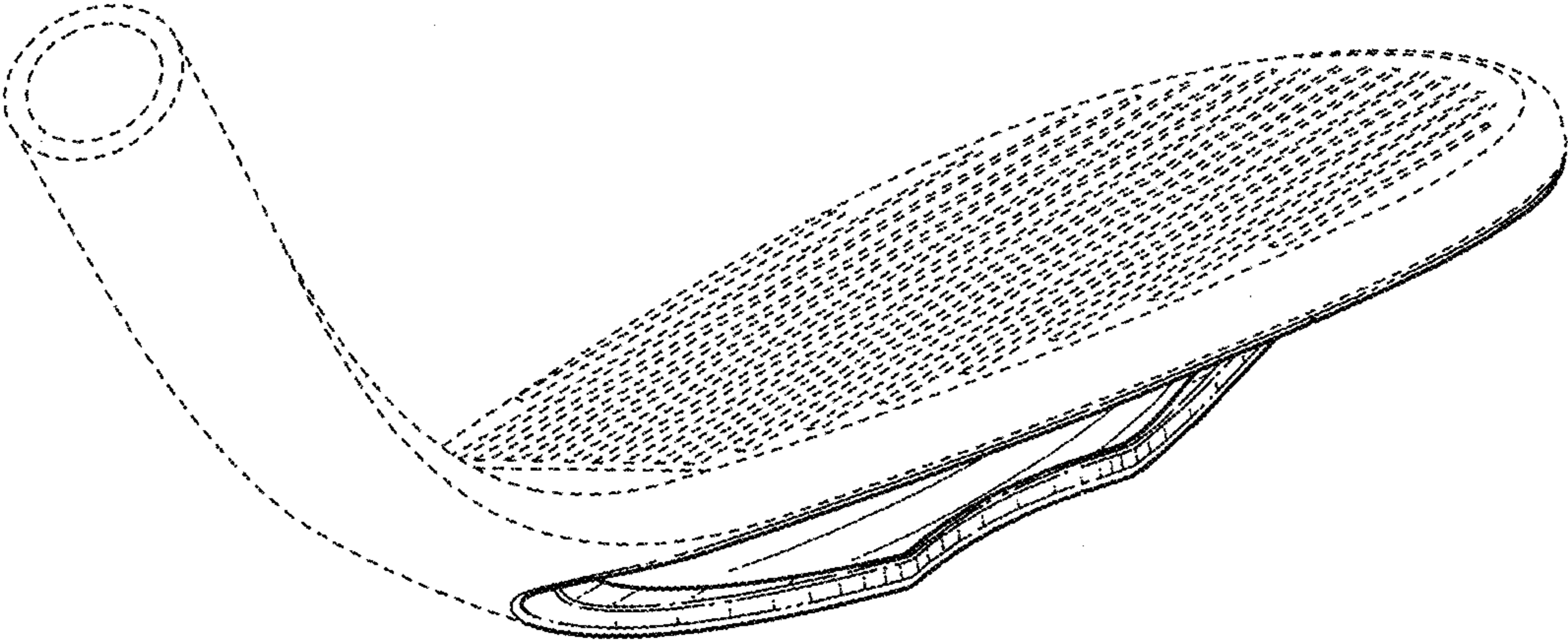

FIG. 1

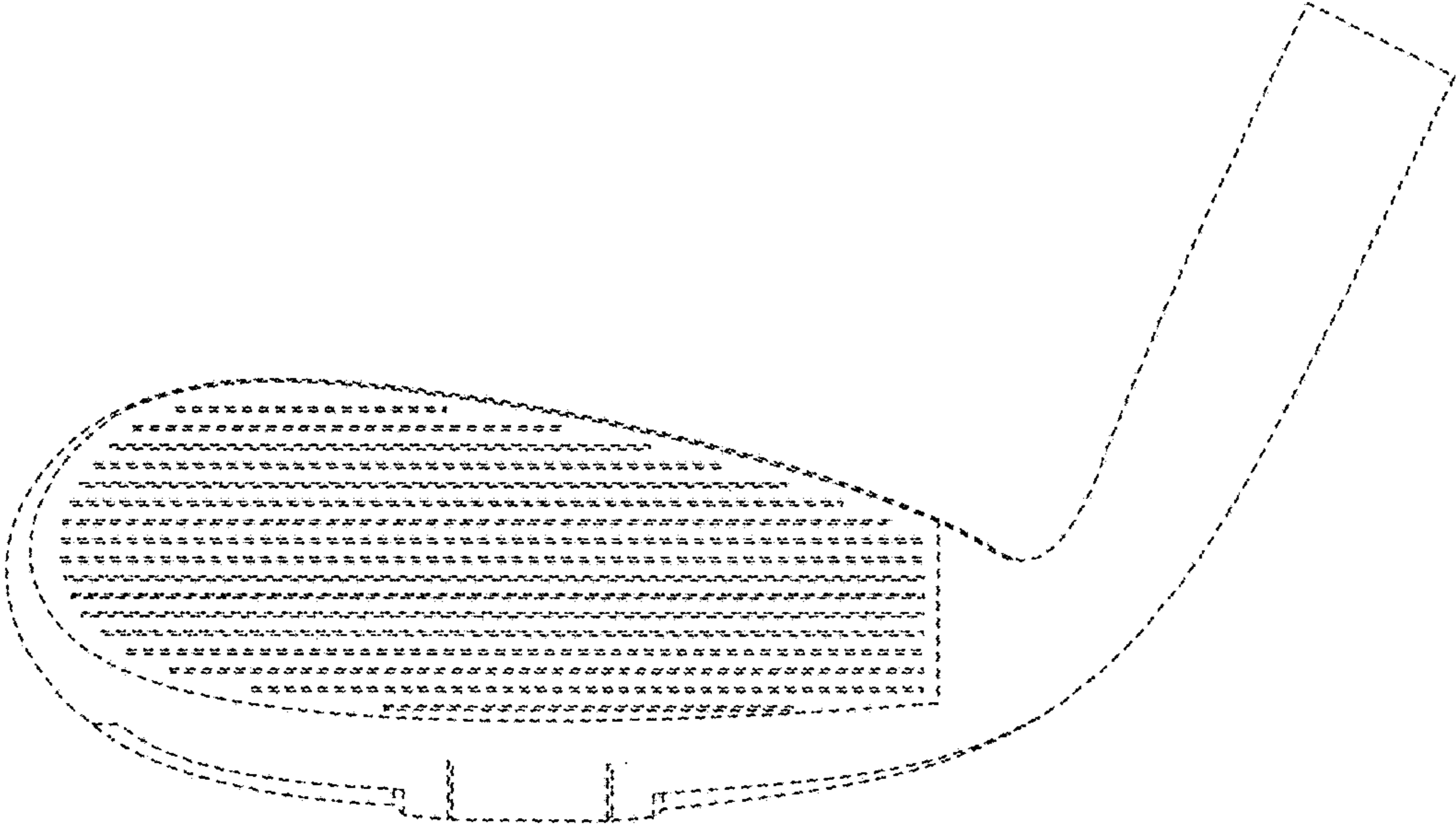

FIG. 2

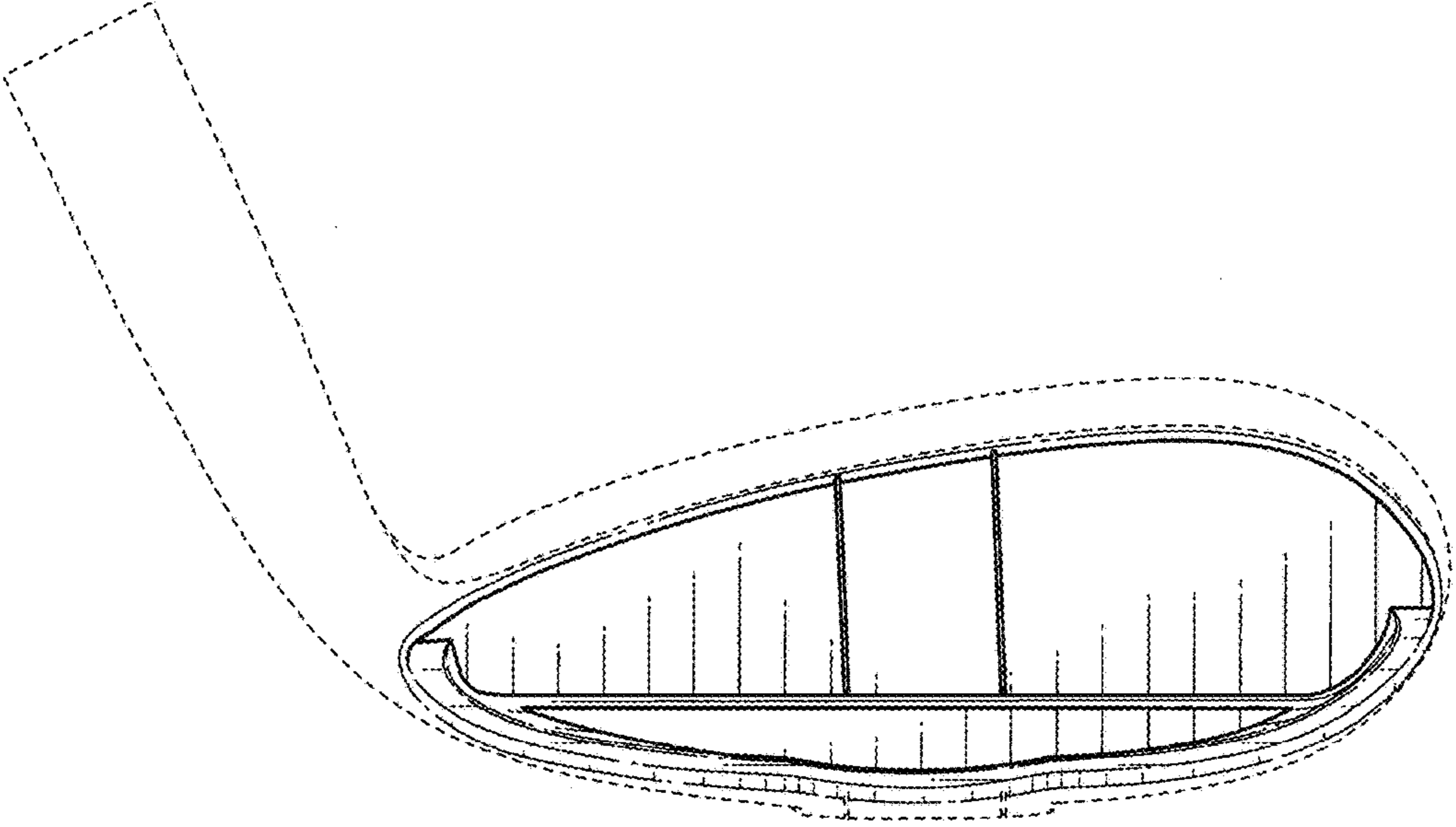

FIG. 3

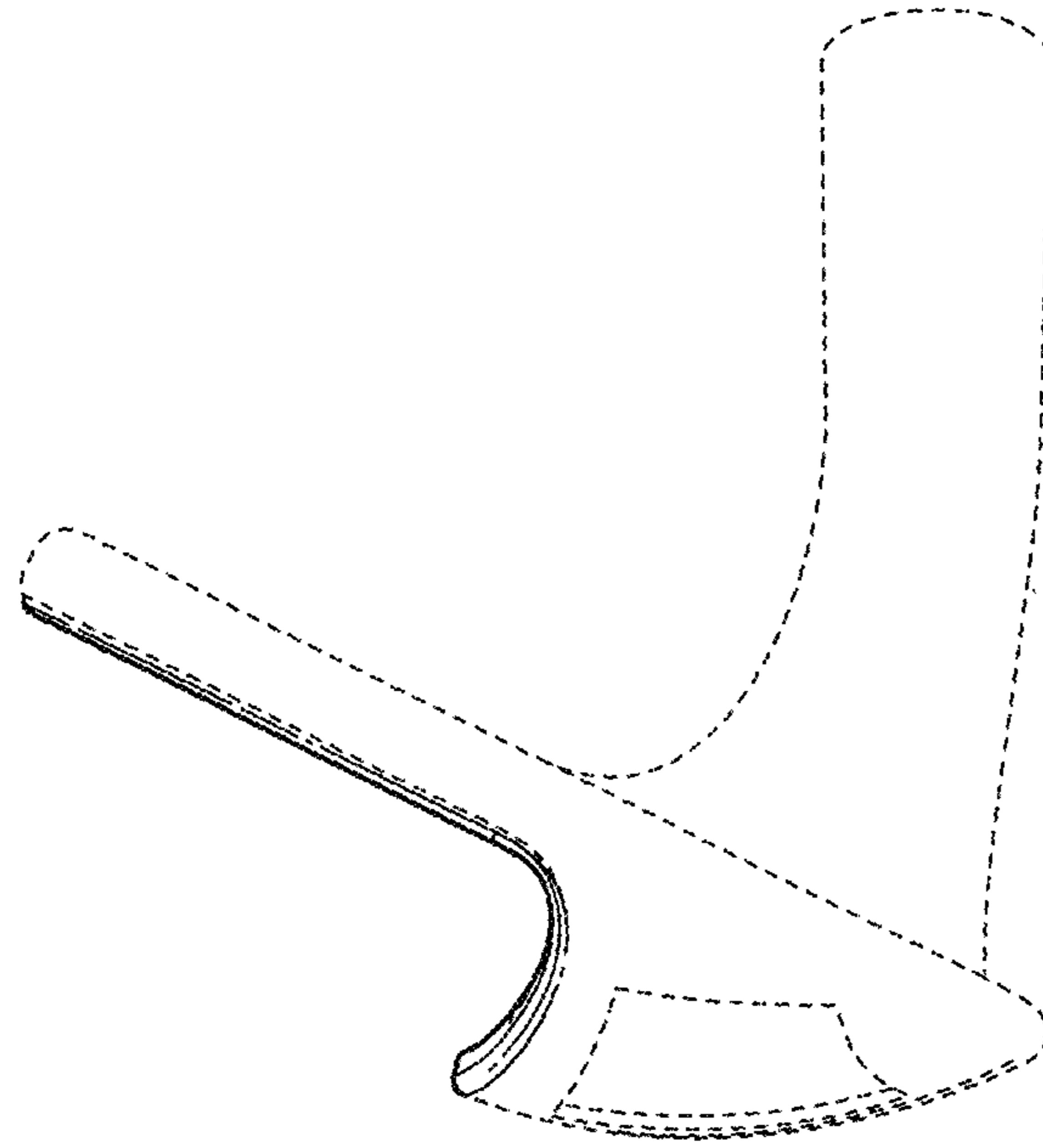

FIG. 4

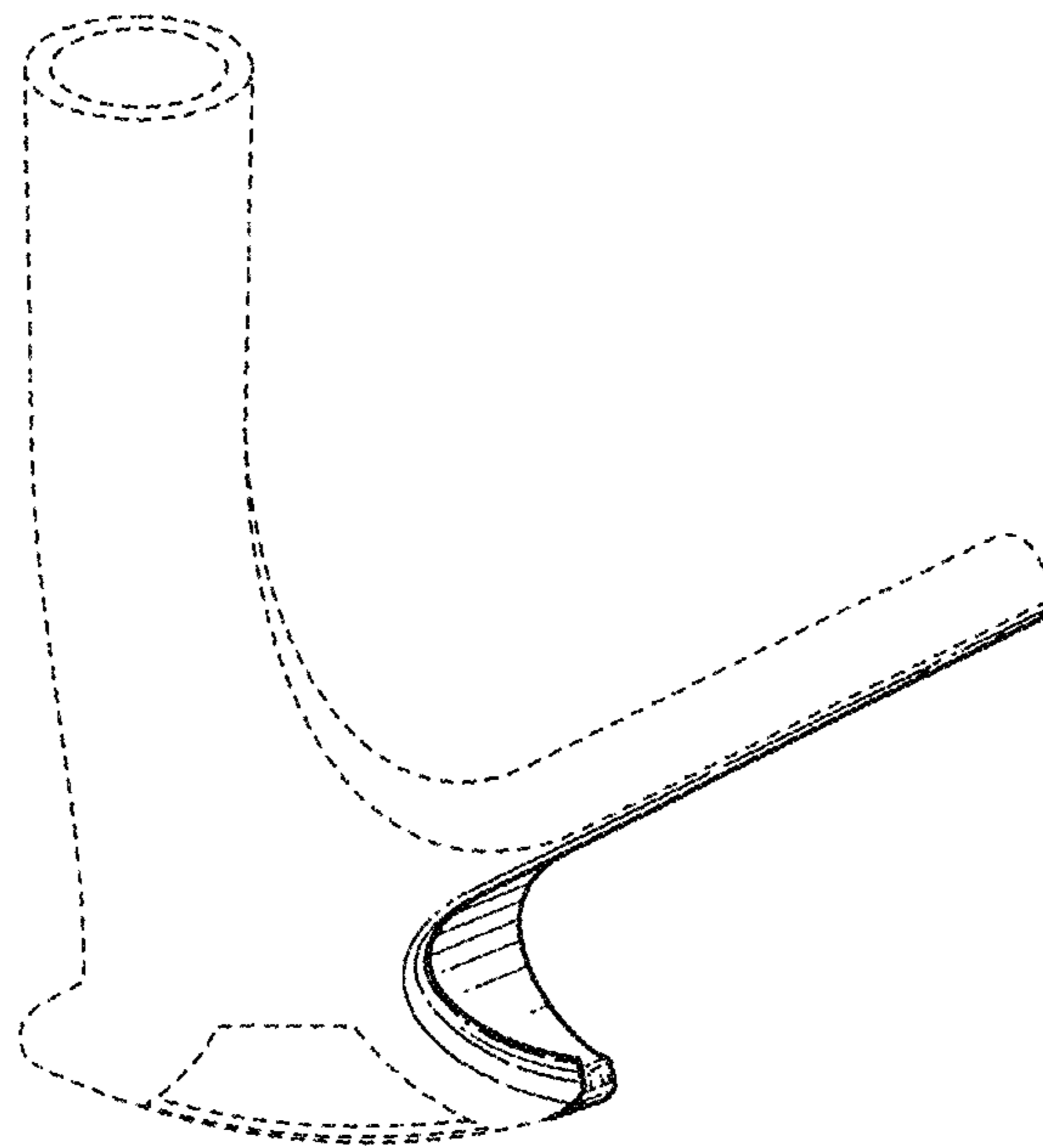

FIG. 5

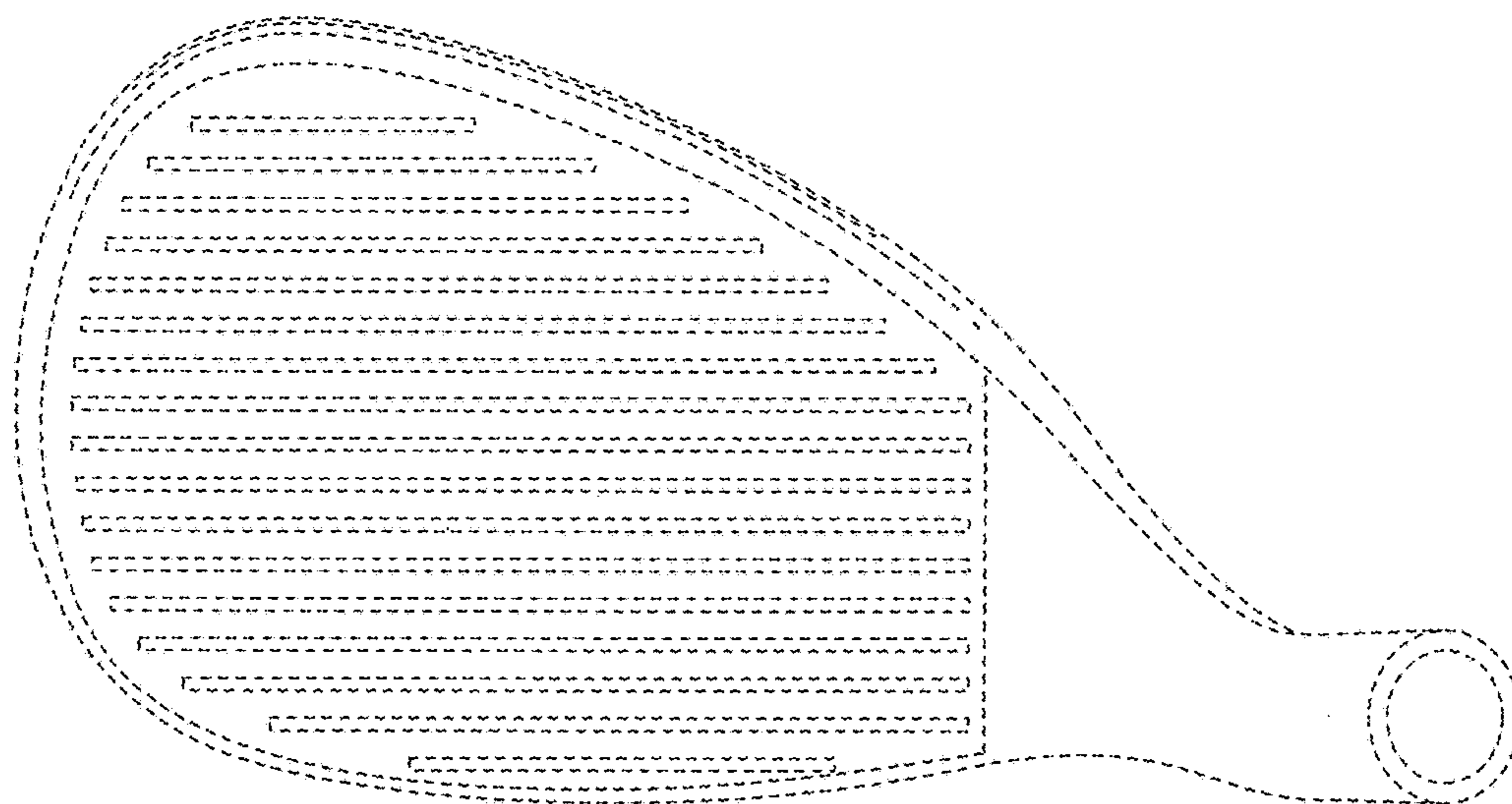

FIG. 6

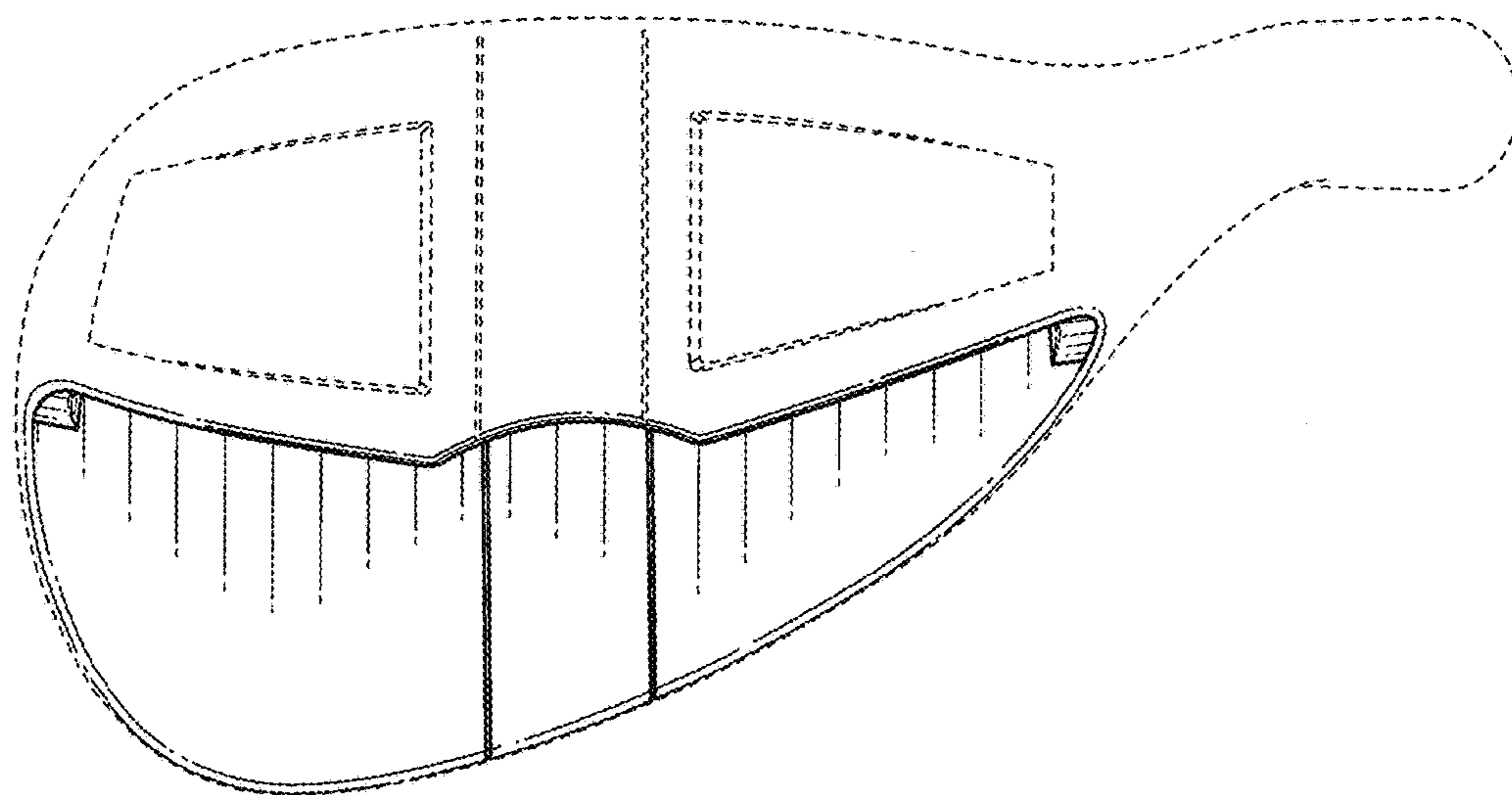

FIG. 7