



US00D803114S

(12) **United States Design Patent** (10) **Patent No.:** **US D803,114 S**  
**Ito et al.** (45) **Date of Patent:** **\*\* Nov. 21, 2017**

(54) **HOOD FOR A TRUCK VEHICLE** D307,126 S 4/1990 Allendorph et al.  
D328,273 S 7/1992 McGrew  
D335,272 S 5/1993 Allendorph et al.  
D391,524 S 3/1998 Anderson  
D391,908 S 3/1998 Allendorph et al.  
D394,624 S 5/1998 Allendorph et al.  
D400,836 S 11/1998 Reynard et al.  
D401,198 S 11/1998 Mueller et al.  
D403,637 S 1/1999 Abalos et al.  
D426,800 S 6/2000 Zimmerman  
D436,335 S 1/2001 Beigel  
D437,574 S 2/2001 Beigel  
D445,384 S 7/2001 Tirey et al.  
D458,197 S 6/2002 Maher et al.  
D466,450 S 12/2002 Maher et al.  
D523,793 S 6/2006 Beigel et al.  
D536,287 S 2/2007 Beigel et al.  
D537,761 S 3/2007 Beigel et al.  
D557,186 S 12/2007 Beigel et al.  
D564,427 S 3/2008 Beigel et al.  
D645,801 S 9/2011 Beigel et al.  
D708,553 S \* 7/2014 Conway ..... D12/96  
D708,985 S \* 7/2014 Peltola ..... D12/96  
D708,986 S \* 7/2014 Conway ..... D12/96

(71) Applicant: **International Truck Intellectual Property Company, LLC**, Lisle, IL (US)

(72) Inventors: **Chris Ito**, Suger Grove, IL (US); **Glen Joel Durmisevich**, Rochester Hills, MI (US); **Christian Michael Hardin**, Waterford, MI (US)

(73) Assignee: **International Truck Intellectual Property Company, LLC**, Lisle, IL (US)

(\*\*) Term: **15 Years**

(21) Appl. No.: **29/597,033**

(22) Filed: **Mar. 14, 2017**

**Related U.S. Application Data**

(62) Division of application No. 29/543,947, filed on Oct. 29, 2015, now Pat. No. Des. 784,870.

(51) **LOC (10) Cl.** ..... **12-16**

(52) **U.S. Cl.**  
USPC ..... **D12/173**

(58) **Field of Classification Search**  
USPC ..... D12/173, 196, 86, 90-92, 181;  
180/69.21, 69.2, 69.22; 296/190.1-190.5,  
296/190.8, 193.11, 37.6  
CPC ..... B62D 25/10; B62D 25/06; B62D 65/02;  
B62D 25/12; B60Q 1/00  
See application file for complete search history.

**References Cited**

**U.S. PATENT DOCUMENTS**

D306,421 S 3/1990 Allendorph et al.  
D306,714 S 3/1990 Allendorph

(Continued)

*Primary Examiner* — Melody N. Brown

(74) *Attorney, Agent, or Firm* — Jeffrey P. Calfa; Mark C. Bach

(57) **CLAIM**

The ornamental design for a hood for a truck vehicle, as shown and described.

**DESCRIPTION**

FIG. 1 is perspective view of a hood for a truck vehicle showing our new design;  
FIG. 2 is a top plan elevational view thereof;  
FIG. 3 is a left side elevational view thereof;  
FIG. 4 is a right side elevational view thereof;  
FIG. 5 is a front elevational view thereof; and,  
FIG. 6 is a rear elevational view thereof.

**1 Claim, 3 Drawing Sheets**

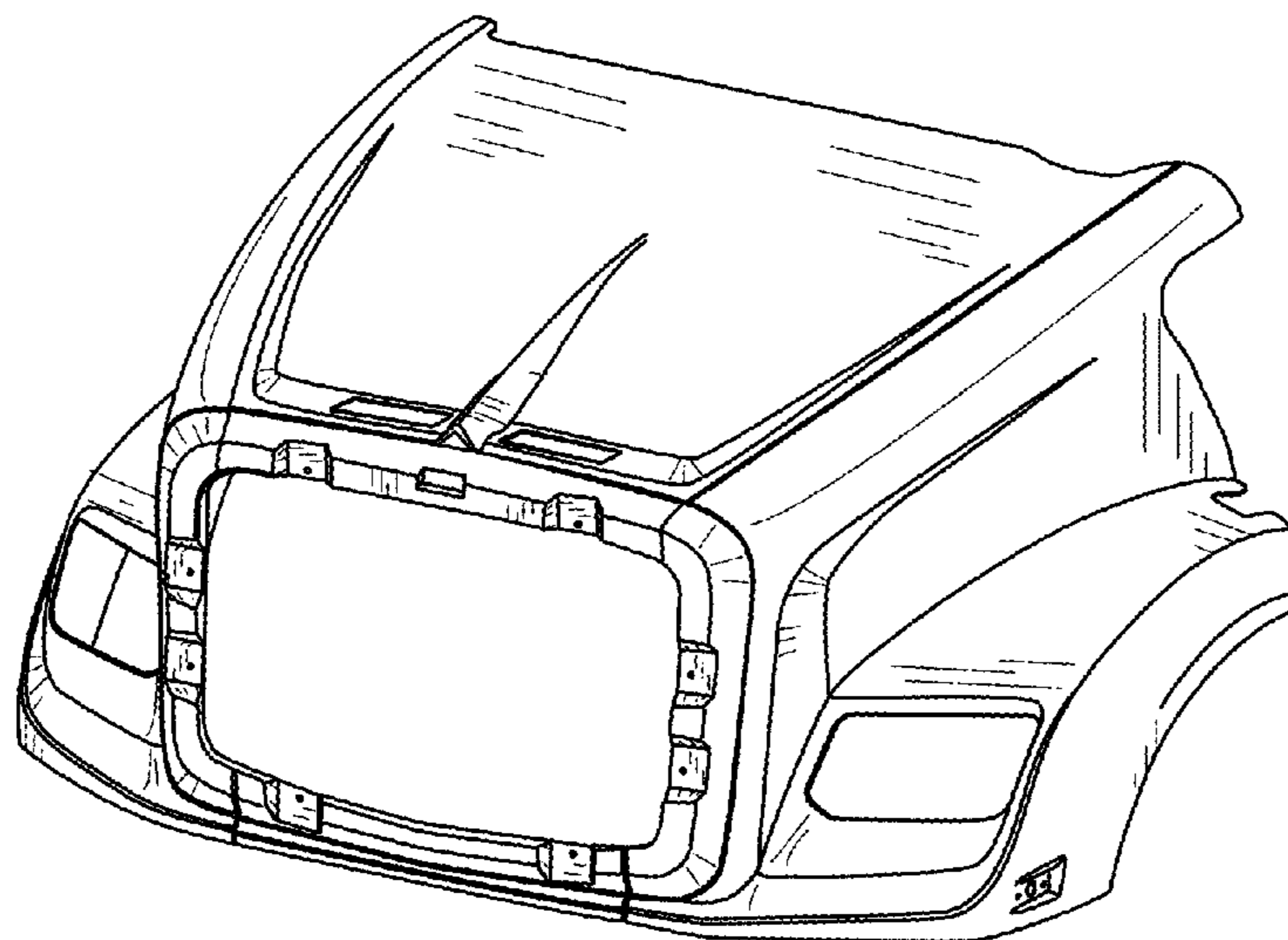

(56)

**References Cited**

U.S. PATENT DOCUMENTS

D709,002 S	7/2014	Ito et al.	
D709,406 S *	7/2014	Conway .....	D12/96
D709,407 S *	7/2014	Conway .....	D12/96
D709,408 S *	7/2014	Peltola .....	D12/96
D711,788 S *	8/2014	Brzustowicz .....	D12/96
D719,879 S *	12/2014	Ito .....	D12/96
D738,273 S *	9/2015	Hanson .....	D12/173
D738,274 S *	9/2015	Hanson .....	D12/173
D743,308 S *	11/2015	Hanson .....	D12/173
D778,216 S	2/2017	Ito et al.	
D778,217 S	2/2017	Ito et al.	
D784,870 S	4/2017	Ito et al.	

\* cited by examiner

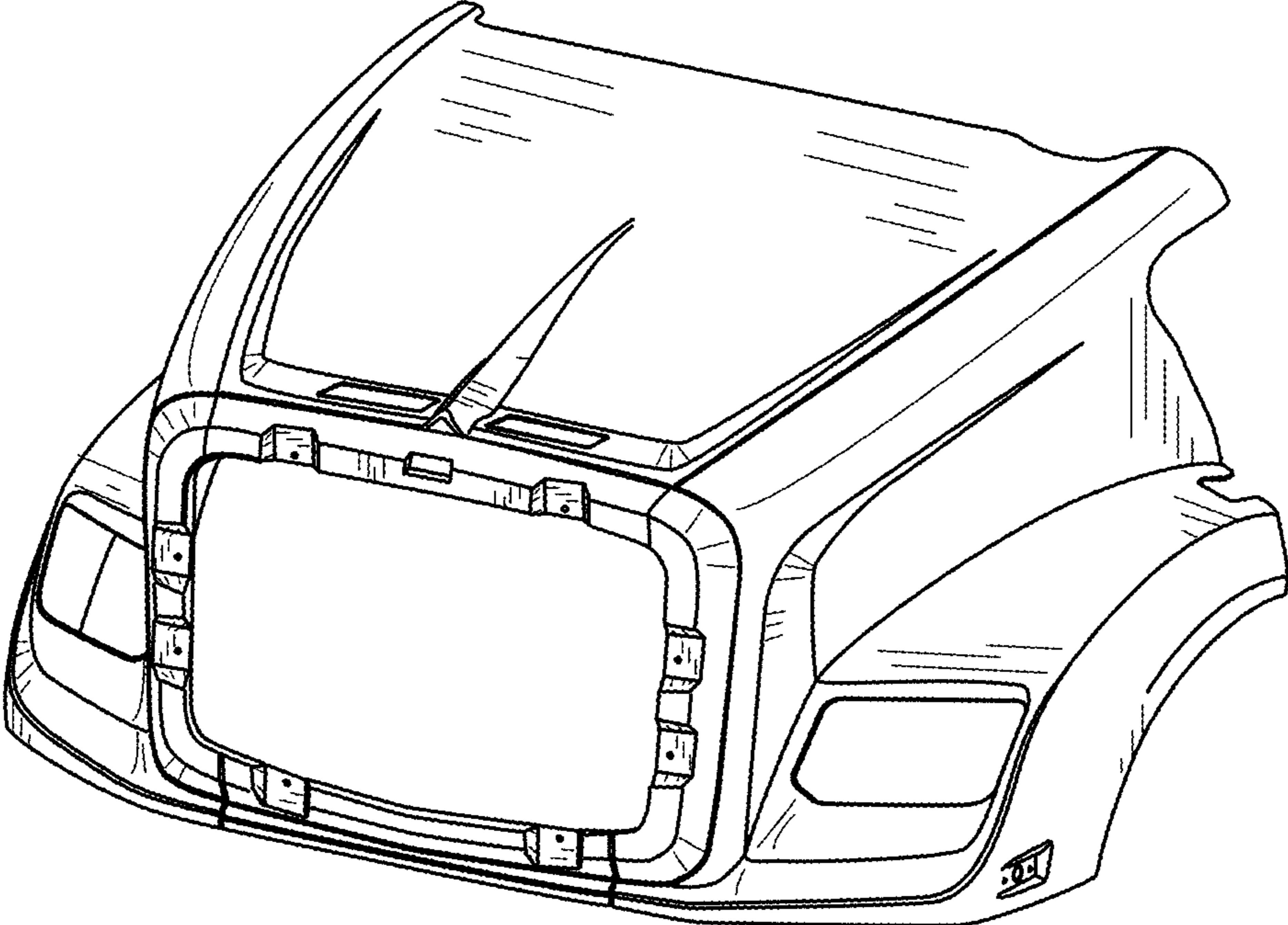
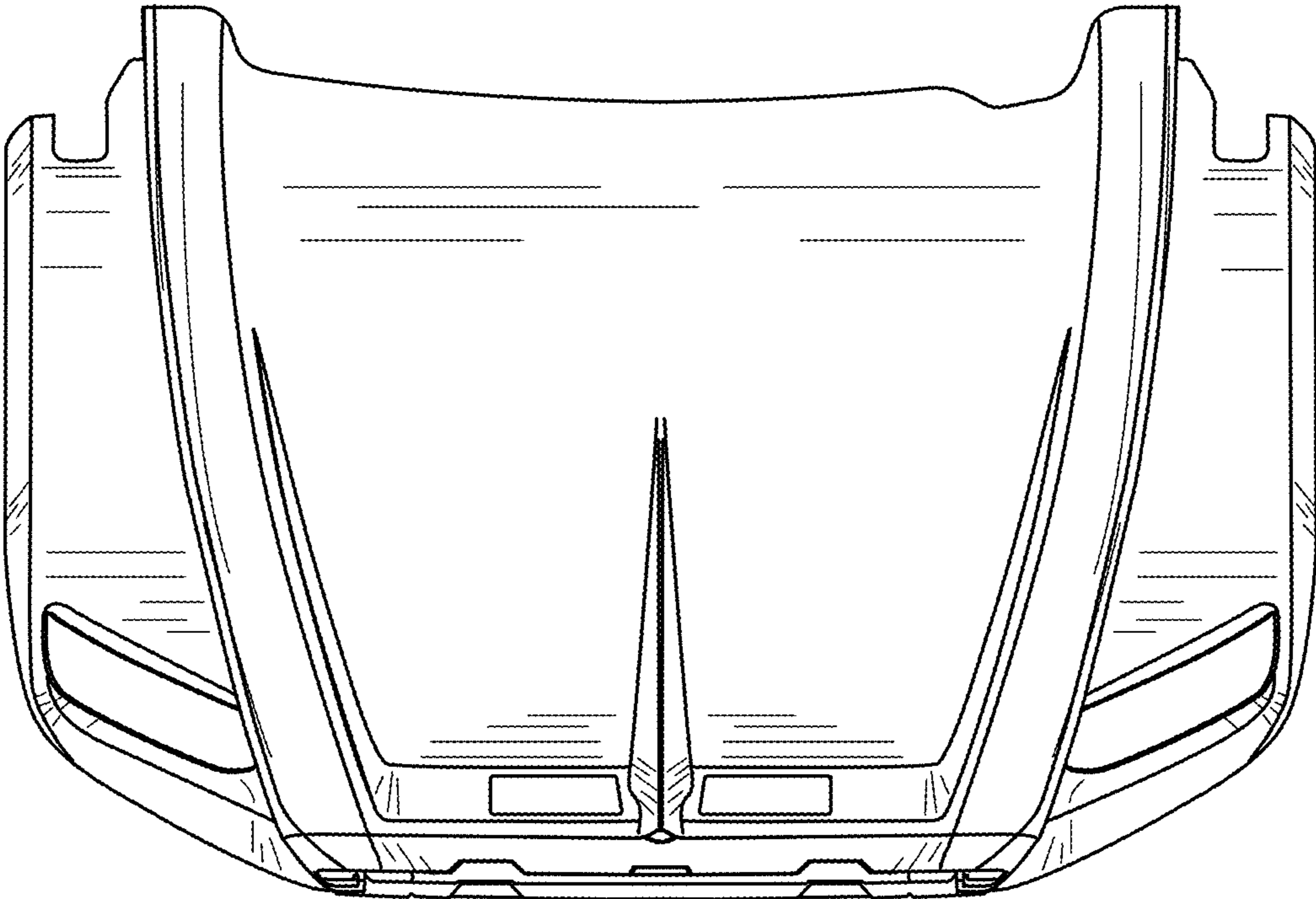
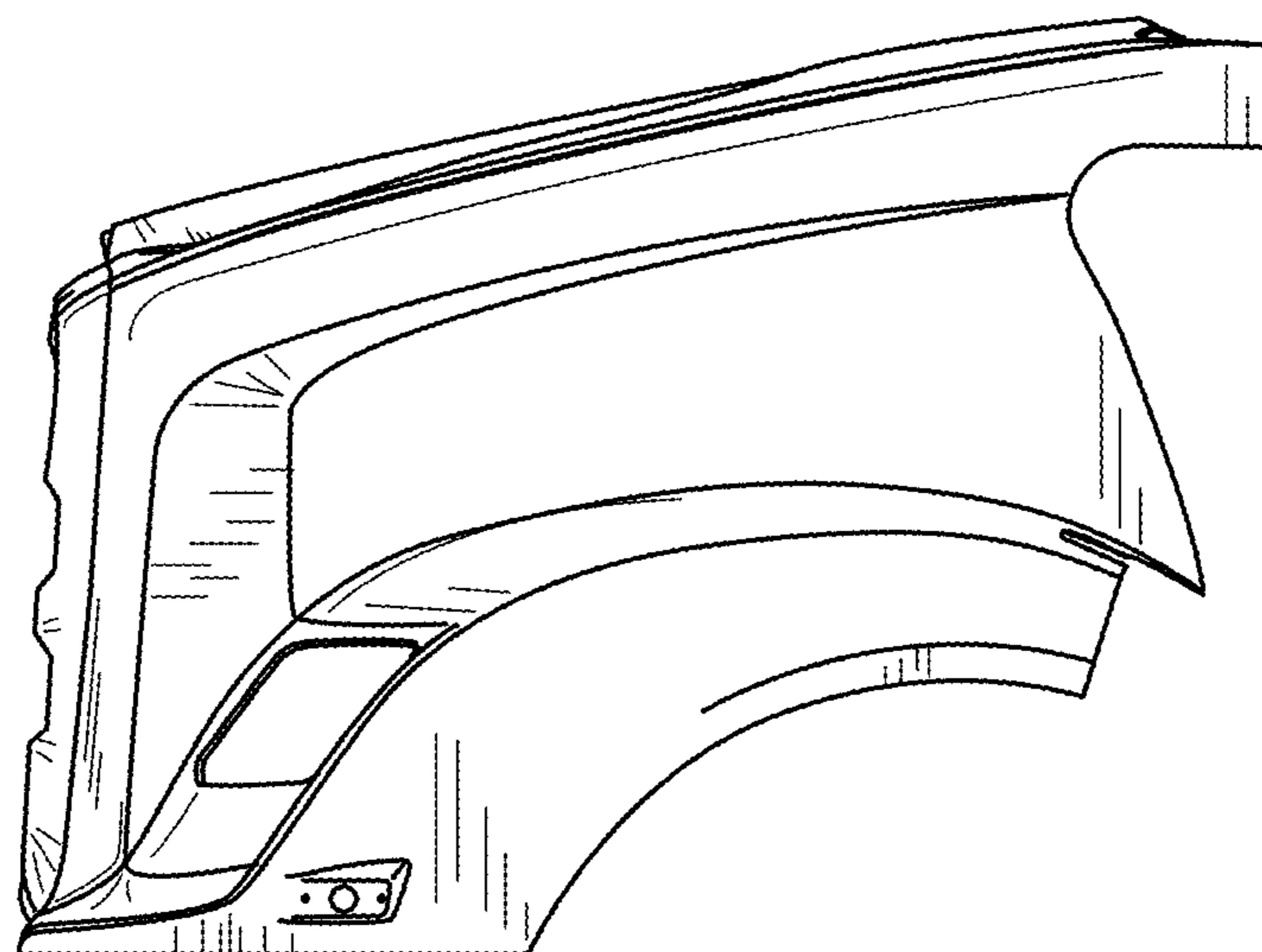

FIG. 1

FIG. 2





**FIG. 3**

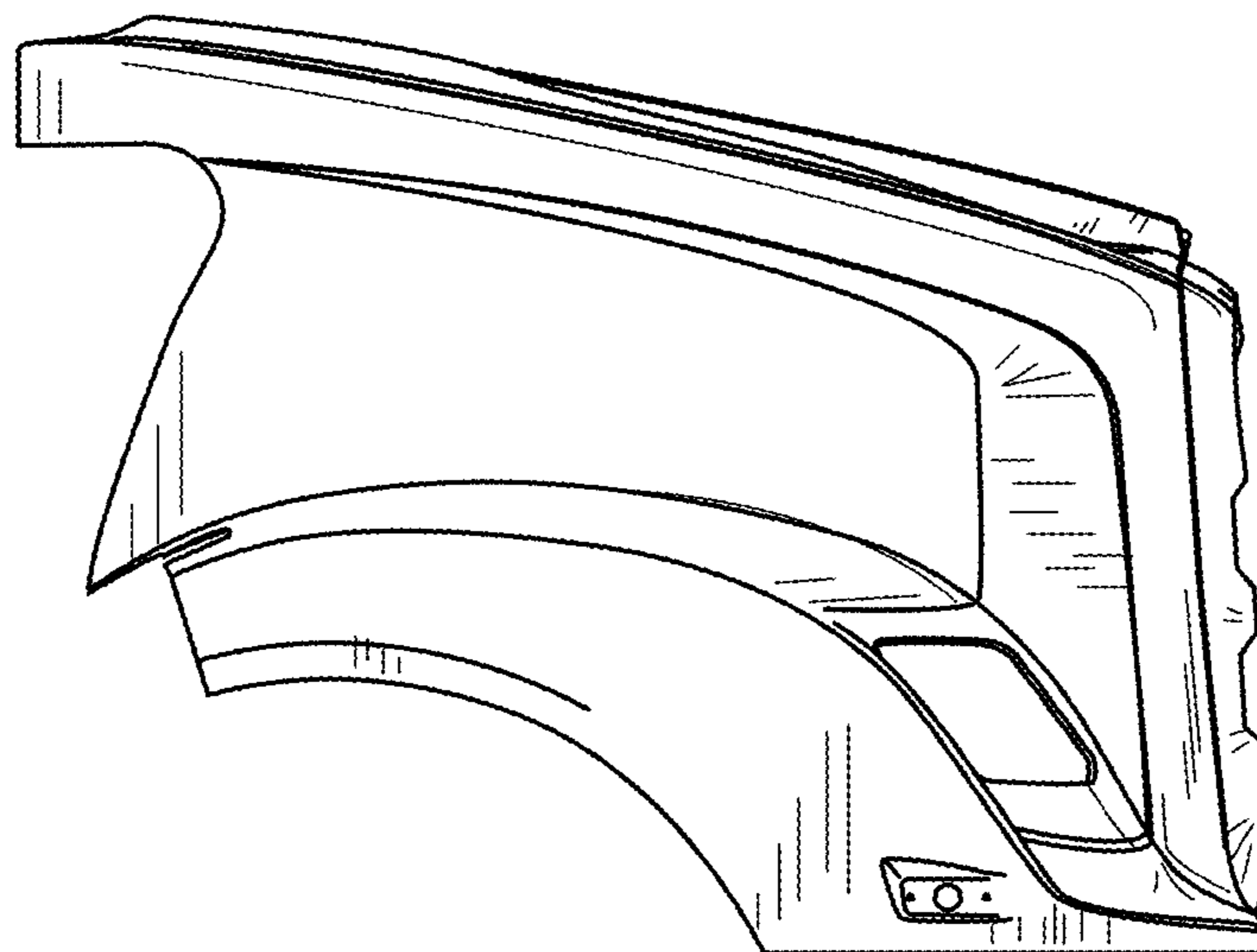

**FIG. 4**

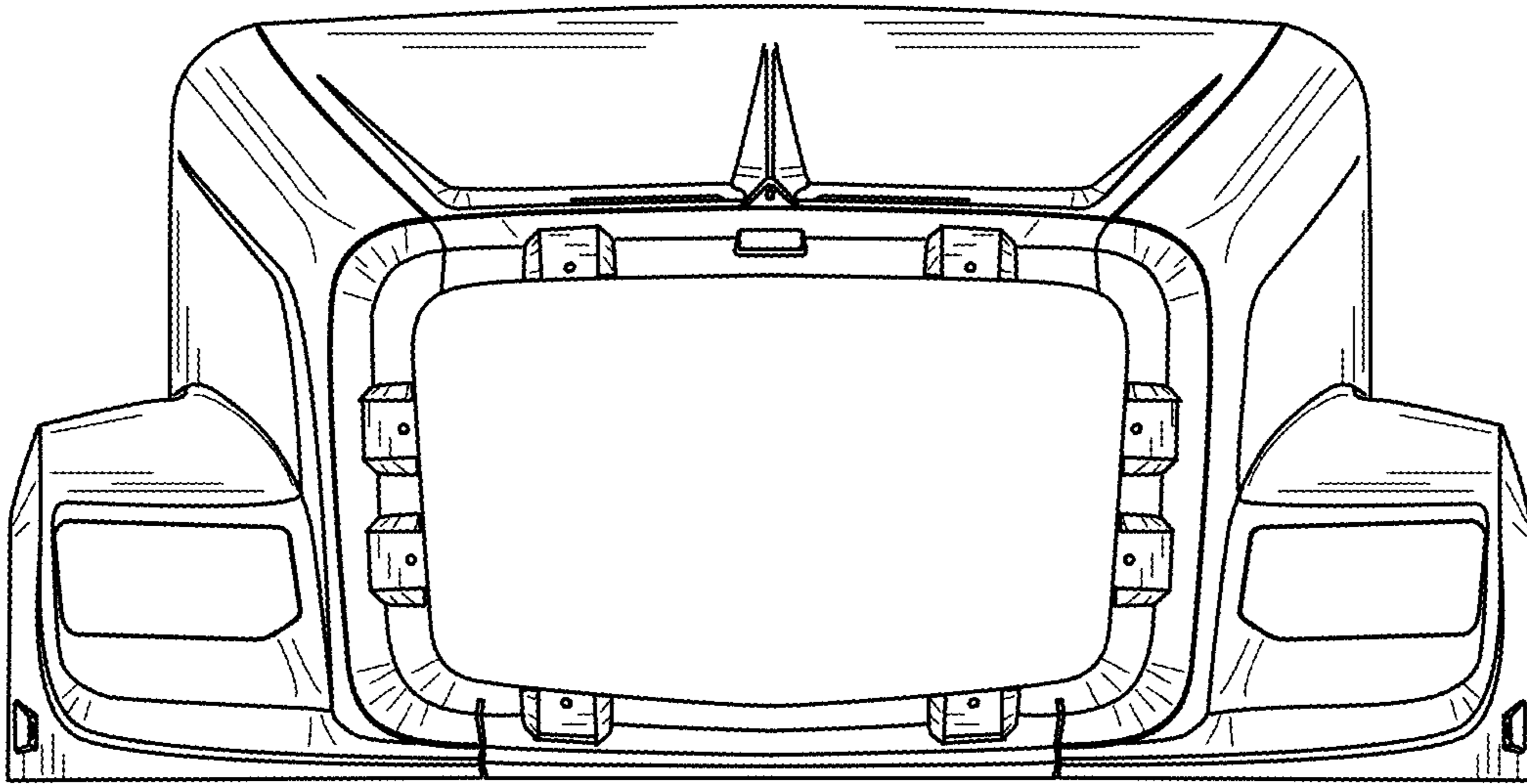

FIG. 5

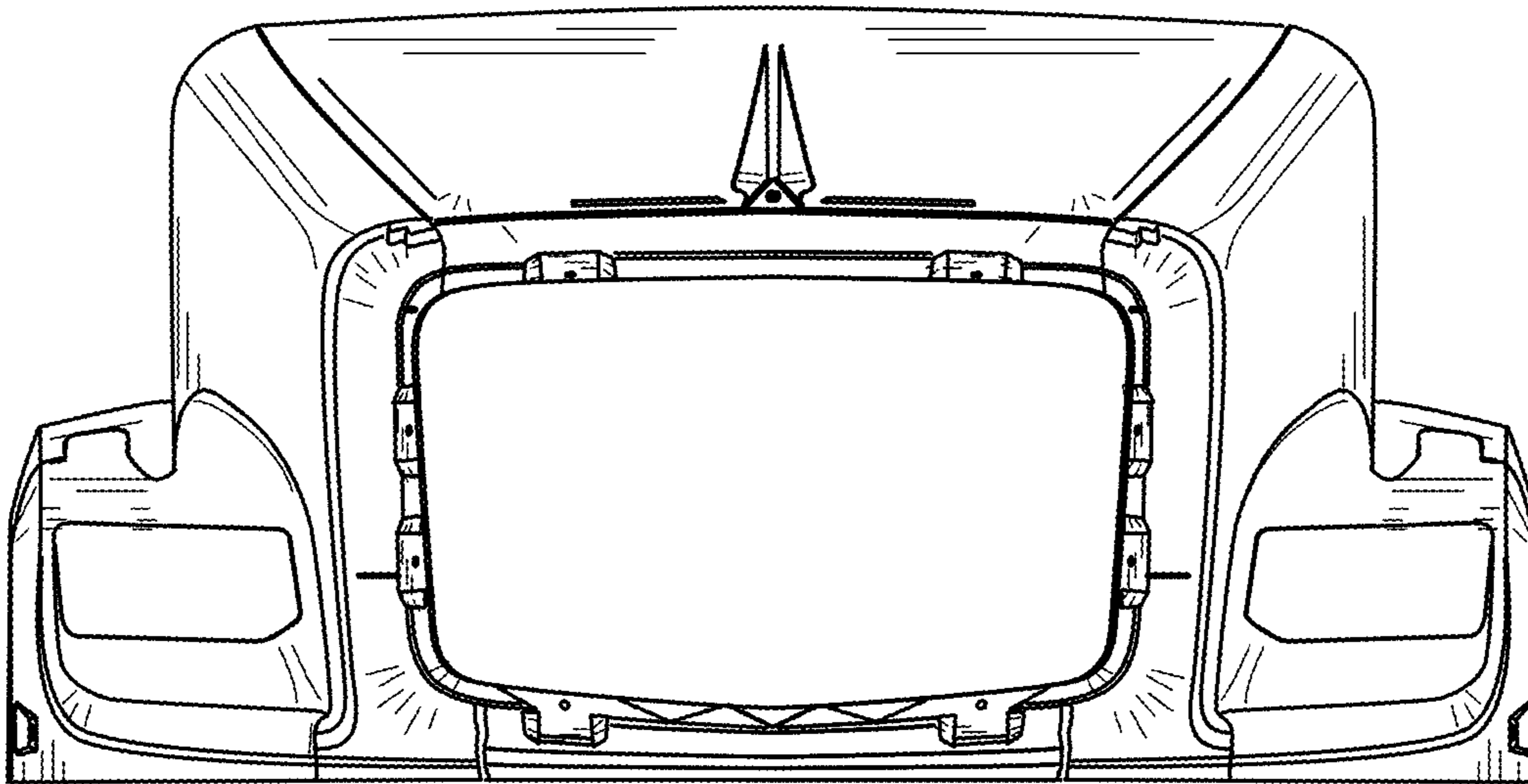

FIG. 6