



US00D803096S

(12) **United States Design Patent**
Di Girolami et al.

(10) **Patent No.:** **US D803,096 S**

(45) **Date of Patent:** **** Nov. 21, 2017**

(54) **SLIDER FOR SLIDE FASTENER**

(71) Applicant: **YKK Corporation**, Tokyo (JP)

(72) Inventors: **Massimiliano Di Girolami**, Cheshire (GB); **Yoshikazu Hamada**, Toyama (JP)

(73) Assignee: **YKK Corporation** (JP)

(**) Term: **15 Years**

(21) Appl. No.: **29/587,974**

(22) Filed: **Dec. 16, 2016**

(30) **Foreign Application Priority Data**

Jun. 17, 2016 (EM) 003227644-0001

(51) **LOC (10) Cl.** **15-07**

(52) **U.S. Cl.**
USPC **D11/221**

(58) **Field of Classification Search**
USPC D11/200–201, 221; 24/381–383,
24/385–387, 414–431, 4, 412; D2/641;
294/3.6

CPC A44B 19/00; A44B 19/02; A44B 19/04;
A44B 19/10; A44B 19/24; A44B 19/26;
A44B 19/30; A44B 19/06
See application file for complete search history.

(56) **References Cited**

U.S. PATENT DOCUMENTS

- 2,599,536 A * 6/1952 Backer A44B 19/306
24/421
- 4,525,903 A * 7/1985 Ishii A44B 19/26
24/429
- D380,984 S * 7/1997 Mizuno D11/221
- 6,550,111 B1 * 4/2003 Garraffa, Jr. A44B 19/16
24/399
- D556,088 S * 11/2007 Cossutti D11/221
- D558,091 S * 12/2007 Cossutti D11/221
- D607,775 S * 1/2010 Miyazaki D11/221

- D612,292 S * 3/2010 Miyazaki D11/221
- D627,258 S * 11/2010 Miyazaki D11/221
- D627,259 S * 11/2010 Miyazaki D11/221
- D631,790 S * 2/2011 Keyaki D11/221
- D643,336 S * 8/2011 Di Girolami D11/221
- D643,779 S * 8/2011 Di Girolami D11/221
- D653,170 S * 1/2012 Hamada D11/221
- D653,171 S * 1/2012 Hamada D11/221
- D653,586 S * 2/2012 Hamada D11/221

(Continued)

FOREIGN PATENT DOCUMENTS

CN 206182509 * 5/2017

OTHER PUBLICATIONS

5# square Metal Zipper Slider zinc alloy slider for handbags, GlobalSources.com, [online], [site visited Sep. 14, 2017]. <URL: <http://www.globalsources.com/gsol/1/Zipper-slider/p/sm/1153296254.htm#1153296254>>.*

(Continued)

Primary Examiner — T. Chase Nelson
Assistant Examiner — Jonathan J Han
(74) *Attorney, Agent, or Firm* — Kilpatrick Townsend & Stockton LLP

(57) **CLAIM**

The ornamental design for a slider for slide fastener, as shown and described.

DESCRIPTION

FIG. 1 is a perspective view of the front, bottom and right side of a slider for slide fastener, showing our new design; FIG. 2 is a front view thereof; FIG. 3 is a rear view thereof; FIG. 4 is a right side view thereof, the left side view being a mirror image thereof; FIG. 5 is a top plan view thereof; and, FIG. 6 is a bottom view thereof.

1 Claim, 6 Drawing Sheets

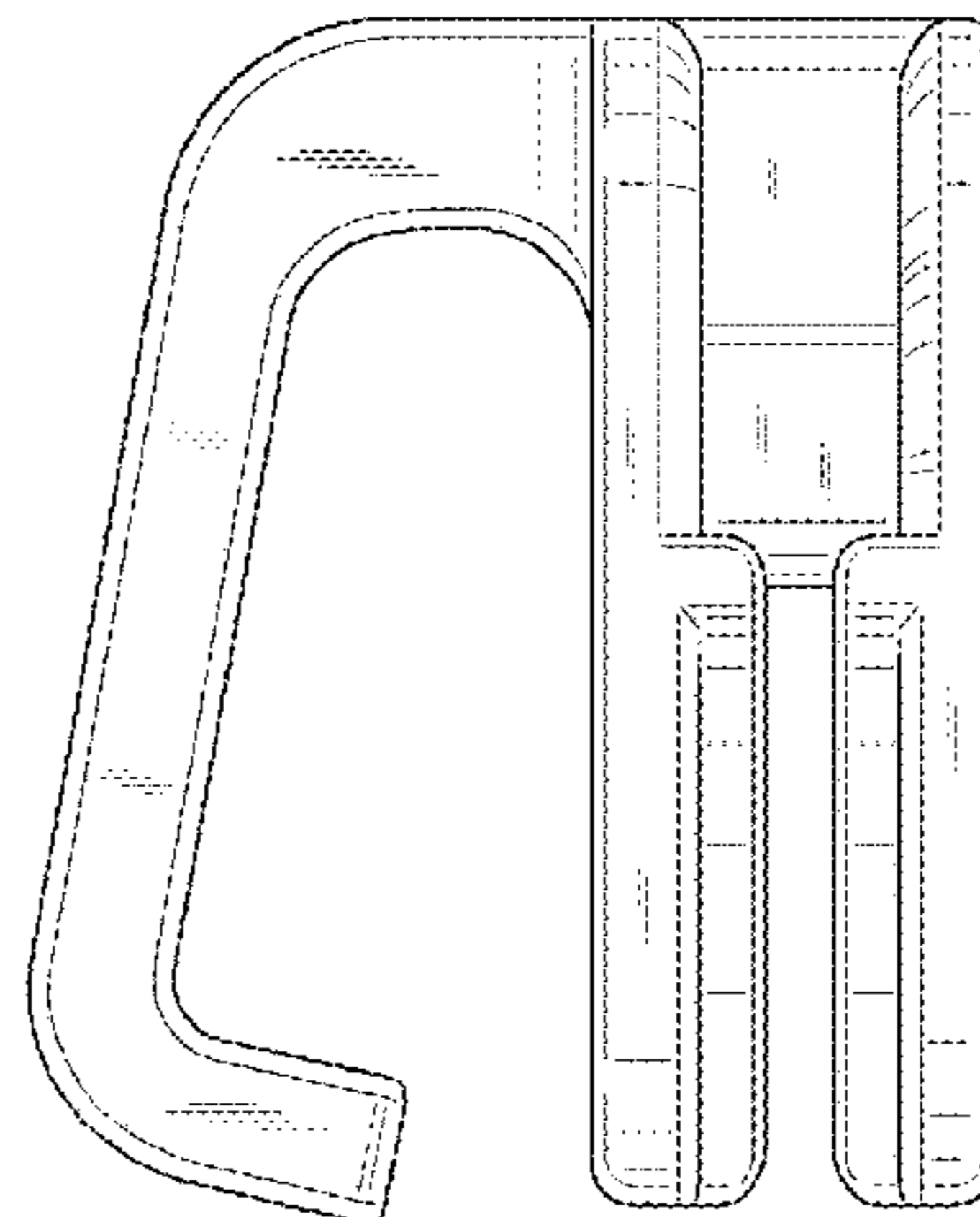
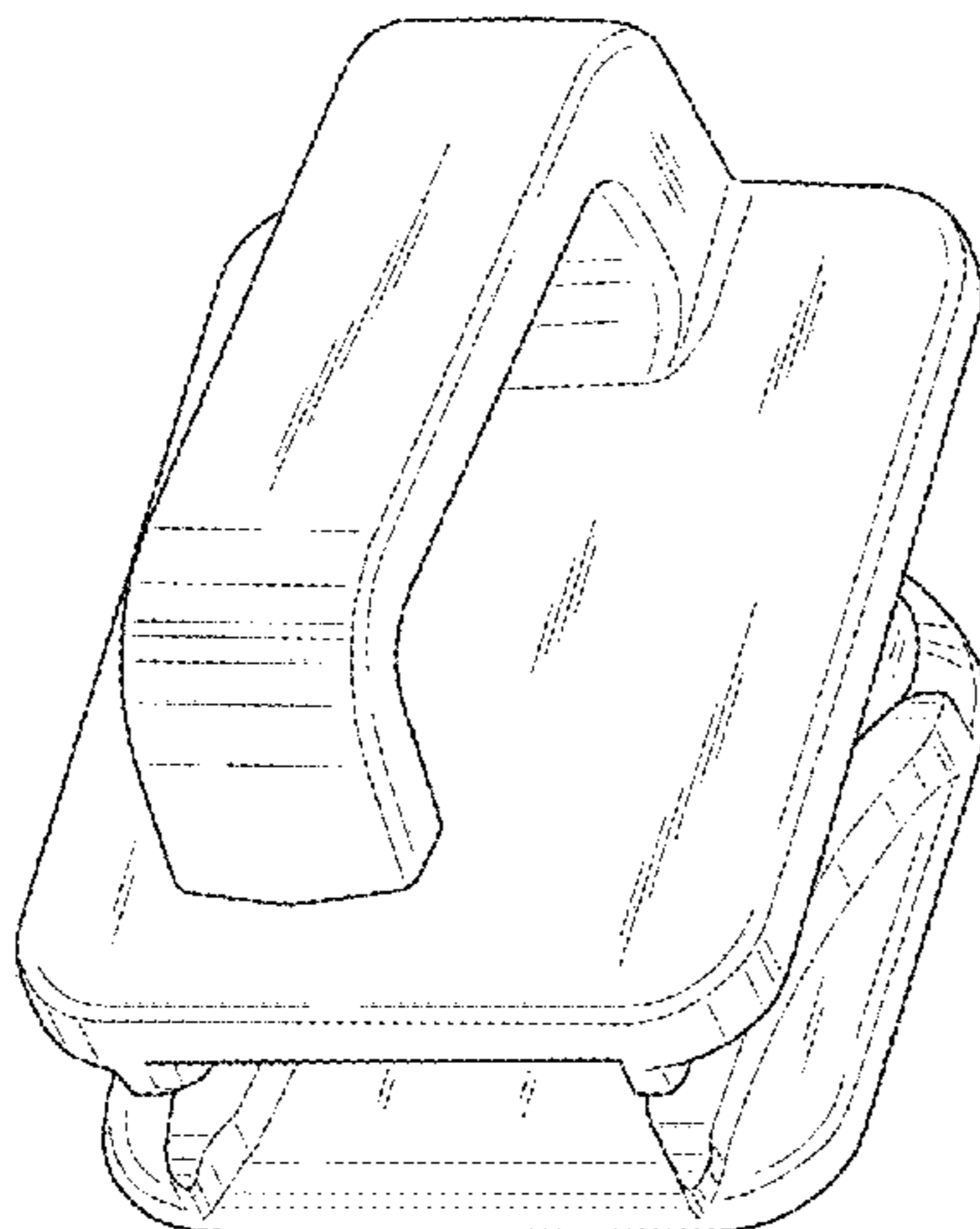

(56)

References Cited

U.S. PATENT DOCUMENTS

D673,480	S *	1/2013	Keyaki	D11/221
D677,600	S *	3/2013	Au	D11/221
D705,124	S *	5/2014	Wang	D11/221
D721,617	S *	1/2015	Ozawa	D11/221
D741,750	S *	10/2015	Ng	D11/221
D780,622	S *	3/2017	Lin	D11/221
D794,504	S *	8/2017	Takazawa	D11/221
D796,993	S *	9/2017	Takazawa	D11/221
D796,994	S *	9/2017	Takazawa	D11/221
2004/0163219	A1 *	8/2004	Wu	A44B 19/262 24/429
2005/0097712	A1 *	5/2005	Raynor	A44B 19/262 24/429
2006/0218758	A1 *	10/2006	Chang	A44B 19/262 24/431
2013/0205549	A1 *	8/2013	Lee	A44B 19/26 24/418
2013/0340213	A1 *	12/2013	Chung	A44B 19/382 24/382
2015/0189954	A1 *	7/2015	Yoneoka	A44B 19/26 24/428
2015/0223572	A1 *	8/2015	Wang	A44B 19/26 24/428

OTHER PUBLICATIONS

Eddie Borgo Yellow Gold Zipper Slide Stud Earrings, NeimanMarcus.com, [online], [site visited Sep. 14, 2017]. <URL: <http://www.neimanmarcus.com/Eddie-Borgo-Yellow-Gold-Zipper-Slide-Stud-Earrings/prod168370007/p.prod>>.*

Universal #8 Aluminum Slider, ZipperStop.com, [online], [site visited Sep. 14, 2017]. <URL: <https://www.zipperstop.com/product/universal-8-aluminum-slider/>>.*

Zipper slider stud earrings, Etsy.com, [online], [site visited Sep. 14, 2017]. <URL: https://www.etsy.com/listing/481484218/zipper-slider-stud-earrings-funky?ga_order=most_relevant&ga_search_type=all&ga_view_type=gallery&ga_search_query=zippersliders&ref=sc_gallery_1&plkey=4c998a528ee0b7b488ca09902a69d4518cab82a4:481484218>.*

YKK #5 Vision Short Tab Zipper Slider—Black—10 Pack, Etsy.com, [online], [site visited Sep. 14, 2017]. <URL: https://www.etsy.com/listing/469737748/ykk-5-vislon-short-tab-zipper-slider?ga_order=most_relevant&ga_search_type=all&ga_view_type=gallery&ga_search_query=zippersliders&ref=sr_gallery_27>.*

Speare Tools Hand Sander w/Med Grit Sponge, Wind-Lock.com, [online], [site visited Sep. 14, 2017]. <URL: <https://www.wind-lock.com/hand-sanders/speare-tools-hand-sander-w-med-grit-sponge-w--spthbsdk200m?returnurl=%2fhand-sanders%2f>>.*

* cited by examiner

Fig. 1

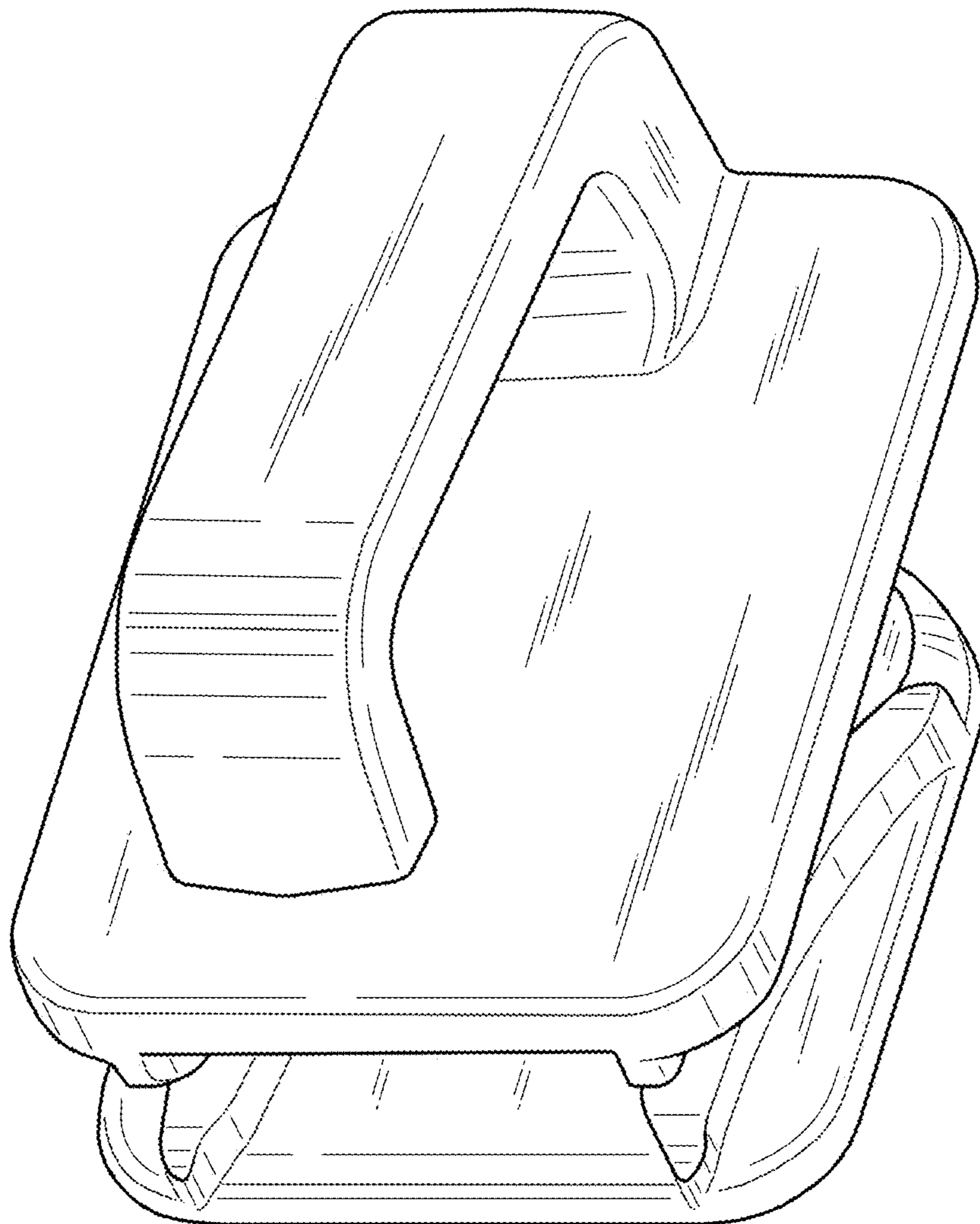

Fig. 2

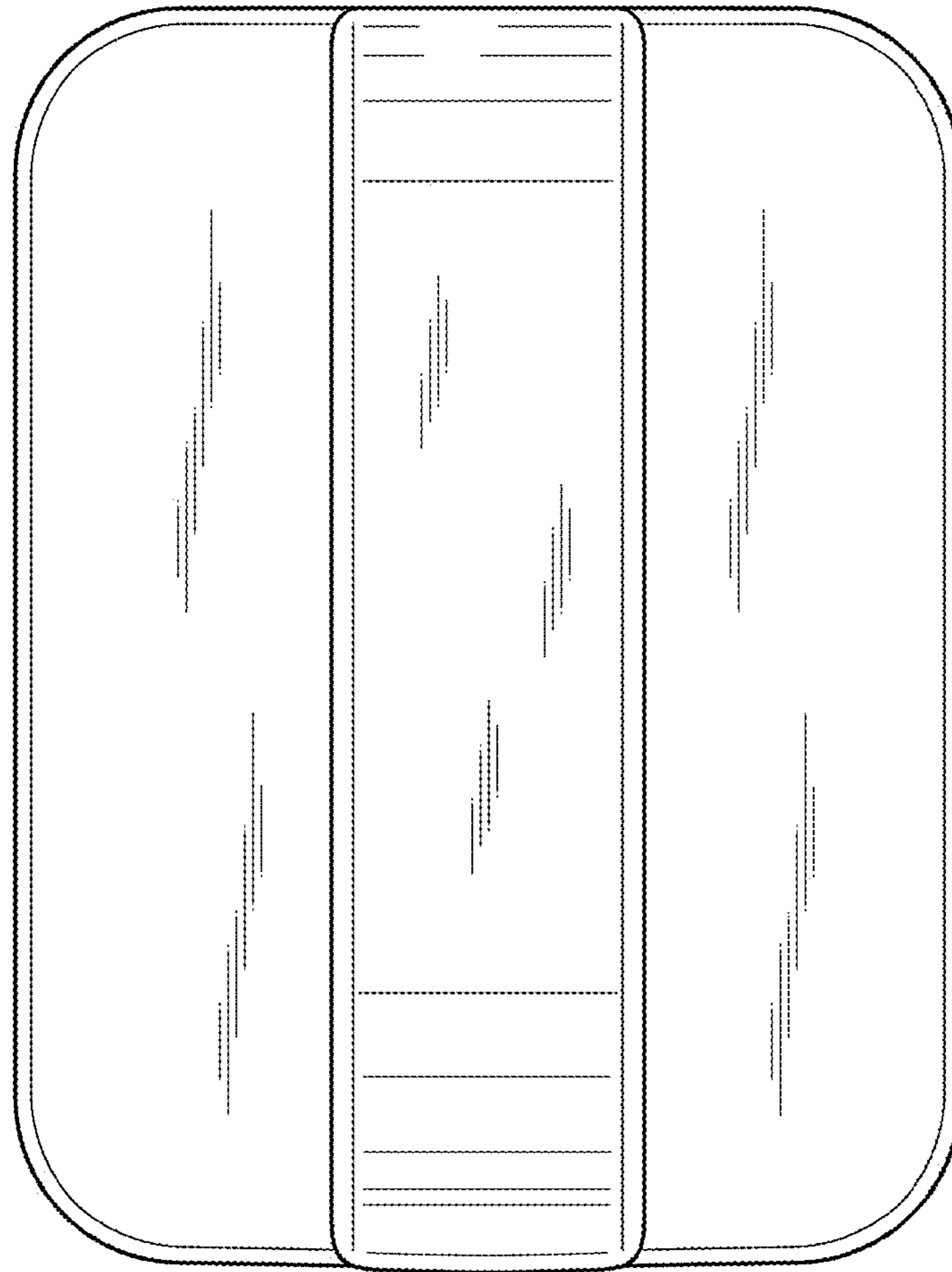

Fig. 3

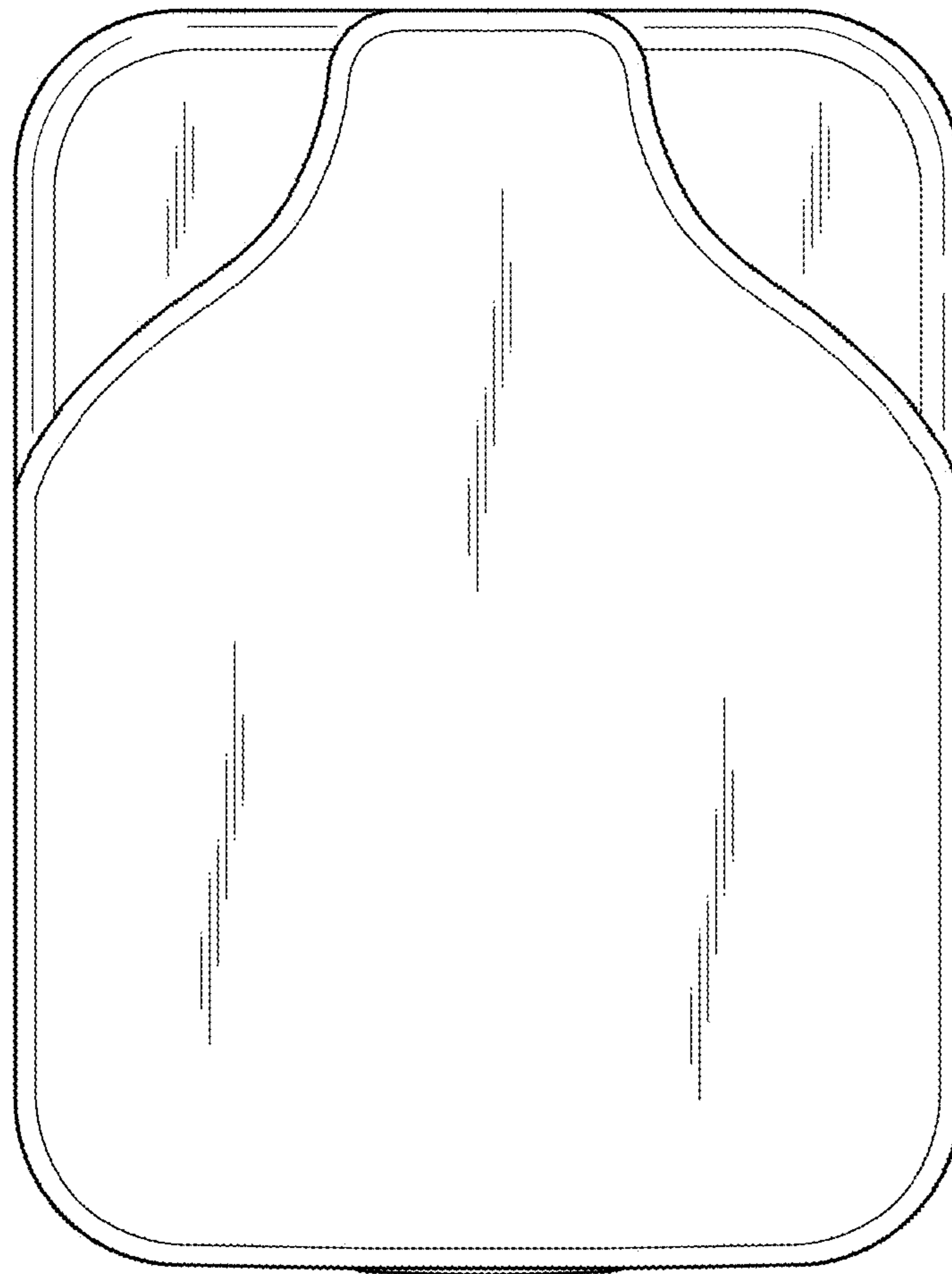

Fig. 4

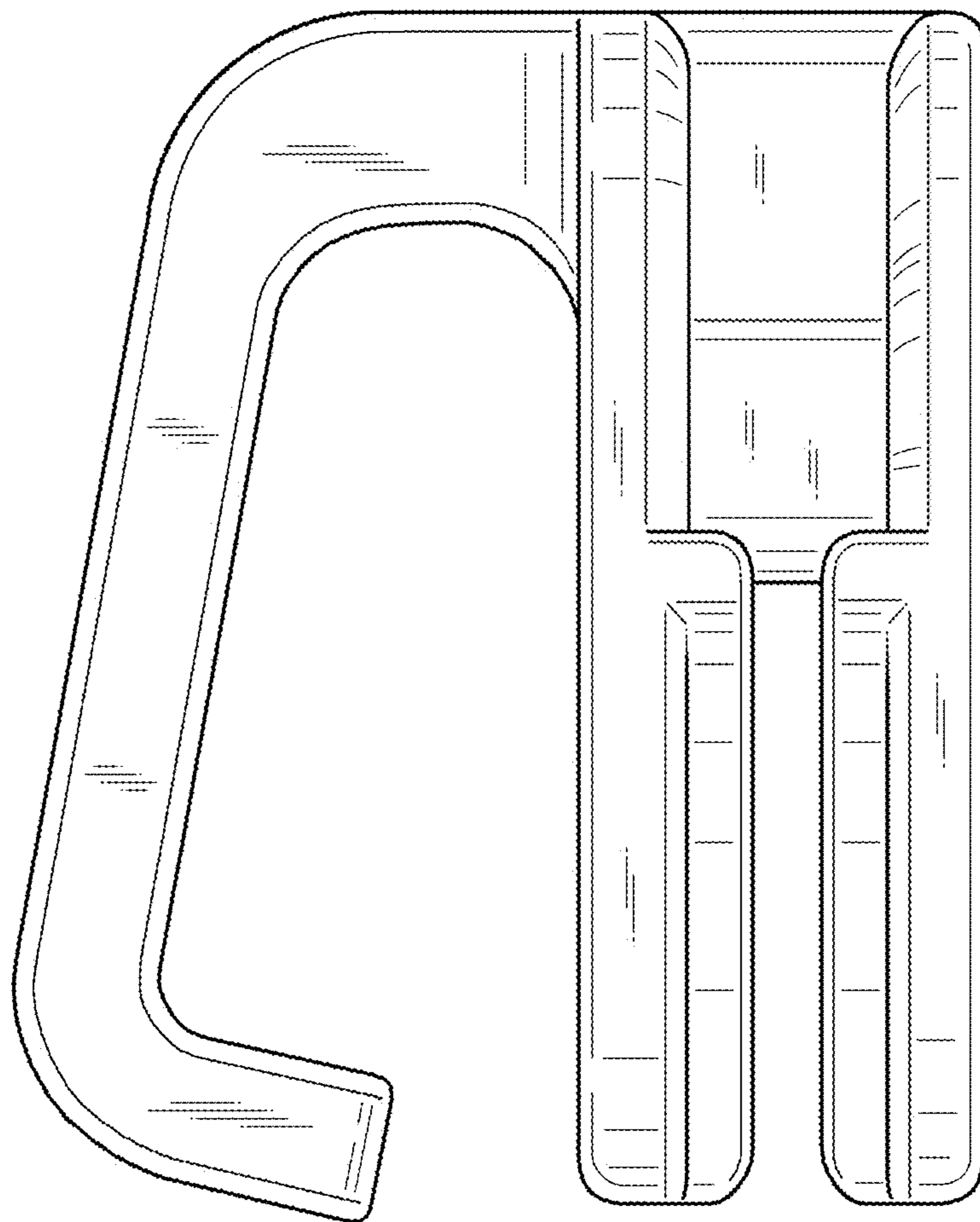

Fig. 5

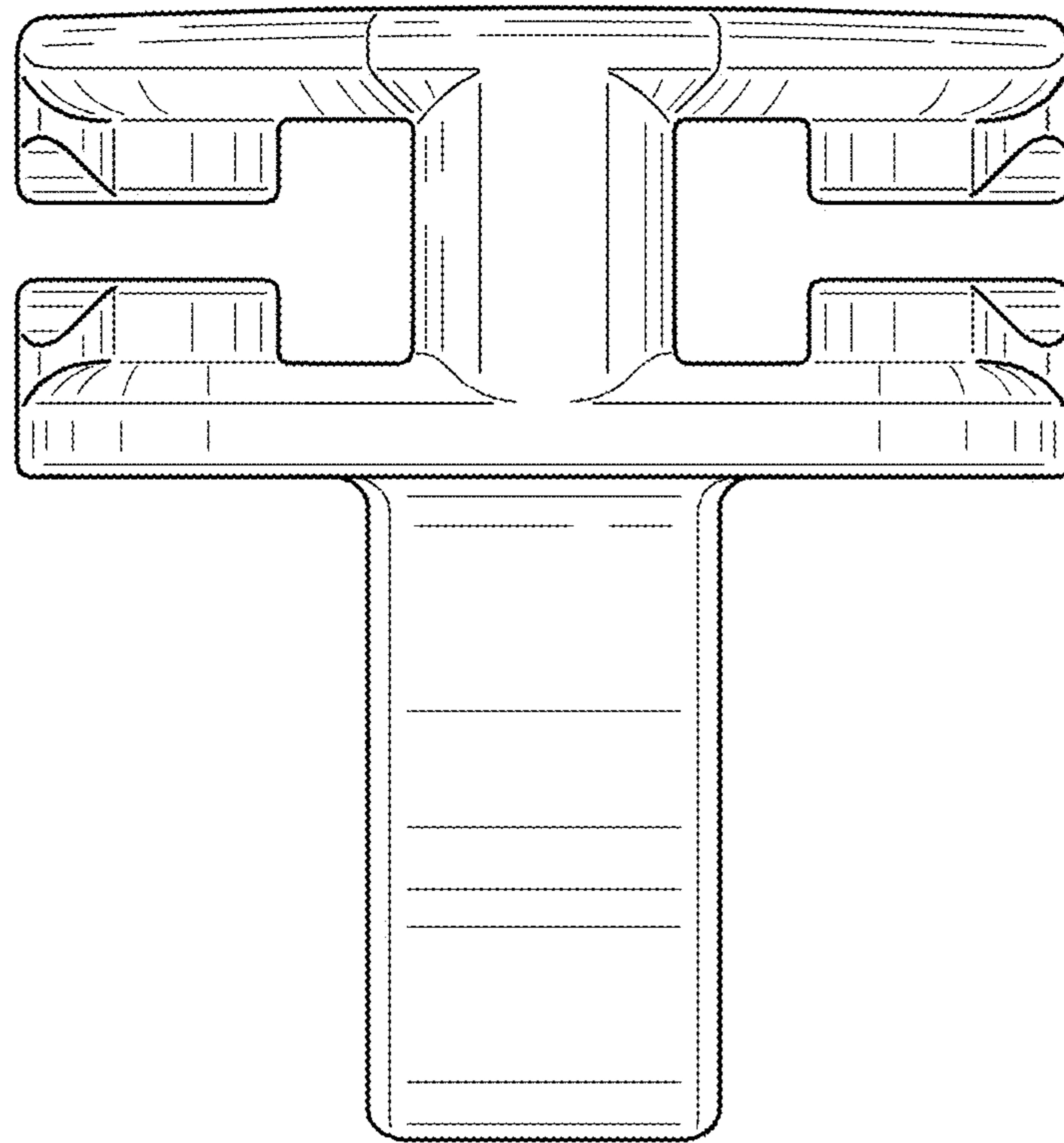

Fig. 6

