



US00D803042S

(12) **United States Design Patent** (10) **Patent No.:** **US D803,042 S**  
**Deshpande et al.** (45) **Date of Patent:** **\*\* Nov. 21, 2017**

(54) **POINT OF SALE PACKAGING**

*Primary Examiner* — Rhea Shields

(71) Applicant: **Cequent Consumer Products, Inc.**,  
Solon, OH (US)

(74) *Attorney, Agent, or Firm* — McDonald Hopkins,  
LLC

(72) Inventors: **Dhananjay Deshpande**, Twinsburg, OH  
(US); **Cynthia Eubank**, Barberton, OH  
(US); **Laurie Heiser**, Sagamore Hills,  
OH (US); **Matt Romanak**, Garfield  
Heights, OH (US)

(57) **CLAIM**

The ornamental design for a point of sale packaging, as  
shown and described.

(73) Assignee: **HORIZON GLOBAL AMERICAS  
INC.**, Plymouth, MI (US)

**DESCRIPTION**

(\*\*) Term: **15 Years**

(21) Appl. No.: **29/587,698**

(22) Filed: **Dec. 15, 2016**

FIG. 1 is a perspective view of a first embodiment of a point  
of sale packaging showing our new design;  
FIG. 2 is a front view thereof;  
FIG. 3 is a rear view thereof;  
FIG. 4 is a first side view thereof;  
FIG. 5 is a second side view thereof;  
FIG. 6 is a top view thereof;  
FIG. 7 is a bottom view thereof;  
FIG. 8 is a perspective view of a second embodiment of a  
point of sale packaging showing our new design;  
FIG. 9 is a front view thereof;  
FIG. 10 is a rear view thereof;  
FIG. 11 is a first side view thereof;  
FIG. 12 is a second side view thereof;  
FIG. 13 is a top view thereof;  
FIG. 14 is a bottom view thereof;  
FIG. 15 is a perspective view of a third embodiment of a  
point of sale packaging showing our new design;  
FIG. 16 is a front view thereof;  
FIG. 17 is a rear view thereof;  
FIG. 18 is a first side view thereof;  
FIG. 19 is a second side view thereof;  
FIG. 20 is a top view thereof;  
FIG. 21 is a bottom view thereof;  
FIG. 22 is a perspective view of a fourth embodiment of a  
point of sale packaging showing our new design;  
FIG. 23 is a front view thereof;  
FIG. 24 is a rear view thereof;  
FIG. 25 is a first side view thereof;  
FIG. 26 is a second side view thereof;  
FIG. 27 is a top view thereof;

**Related U.S. Application Data**

(62) Division of application No. 29/540,915, filed on Sep.  
29, 2015, now Pat. No. Des. 774,884, which is a  
(Continued)

(51) **LOC (10) Cl.** ..... **09-03**

(52) **U.S. Cl.**  
USPC ..... **D9/415**

(58) **Field of Classification Search**  
USPC ..... D9/415, 722, 456, 457, 749, 418, 423,  
D9/424, 428, 431, 499, 721, 455;  
(Continued)

(56) **References Cited**

**U.S. PATENT DOCUMENTS**

42,943 A \* 5/1864 Hance ..... A47G 23/025  
206/572  
2,322,057 A \* 6/1943 Poutinen ..... G09F 5/04  
206/348

(Continued)

(Continued)

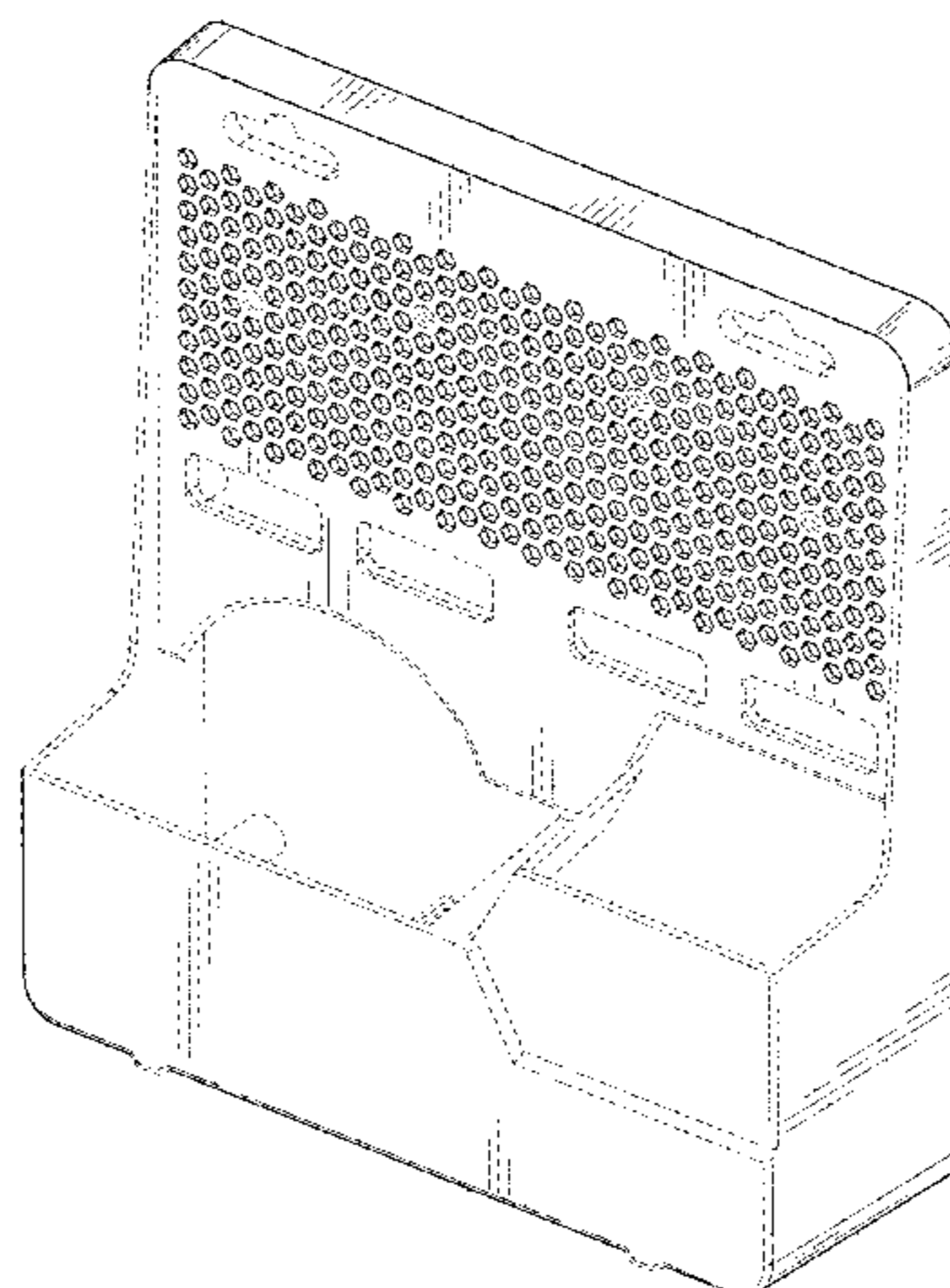

FIG. 28 is a bottom view thereof;  
 FIG. 29 is a perspective view of a fifth embodiment of a point of sale packaging showing our new design;  
 FIG. 30 is a front view thereof;  
 FIG. 31 is a rear view thereof;  
 FIG. 32 is a first side view thereof;  
 FIG. 33 is a second side view thereof;  
 FIG. 34 is a top view thereof;  
 FIG. 35 is a bottom view thereof;  
 FIG. 36 is a perspective view of a sixth embodiment of a point of sale packaging showing our new design;  
 FIG. 37 is a front view thereof;  
 FIG. 38 is a rear view thereof;  
 FIG. 39 is a first side view thereof;  
 FIG. 40 is a second side view thereof;  
 FIG. 41 is a top view thereof;  
 FIG. 42 is a bottom view thereof;  
 FIG. 43 is a perspective view of a seventh embodiment of a point of sale packaging showing our new design;  
 FIG. 44 is a front view thereof;  
 FIG. 45 is a rear view thereof;  
 FIG. 46 is a first side view thereof;  
 FIG. 47 is a second side view thereof;  
 FIG. 48 is a top view thereof;  
 FIG. 49 is a bottom view thereof;  
 FIG. 50 is a perspective view of an eighth embodiment of a point of sale packaging showing our new design;  
 FIG. 51 is a front view thereof;  
 FIG. 52 is a rear view thereof;  
 FIG. 53 is a first side view thereof;  
 FIG. 54 is a second side view thereof;  
 FIG. 55 is a top view thereof;  
 FIG. 56 is a bottom view thereof;  
 FIG. 57 is a perspective view of a ninth embodiment of a point of sale packaging showing our new design;  
 FIG. 58 is a front view thereof;  
 FIG. 59 is a rear view thereof;  
 FIG. 60 is a first side view thereof;  
 FIG. 61 is a second side view thereof;  
 FIG. 62 is a top view thereof; and,  
 FIG. 63 is a bottom view thereof.  
 In the drawings, the broken lines are for the purpose of illustrating environment only and form no part of the claimed design.

1 Claim, 45 Drawing Sheets

**Related U.S. Application Data**

division of application No. 29/518,546, filed on Feb. 25, 2015, now Pat. No. Des. 742,215, which is a division of application No. 29/464,998, filed on Aug. 22, 2013, now Pat. No. Des. 730,168.

(58) **Field of Classification Search**

USPC ..... D3/265; D20/1; D6/678.3, 683; D14/251; 211/41.1; 206/320, 572, 348, 206/49, 779  
 CPC ..... A47G 23/025; A47F 7/0042; A63H 3/50; B65D 85/677; B65D 5/5021; B60R 11/02; G09F 5/04

See application file for complete search history.

(56) **References Cited**

U.S. PATENT DOCUMENTS

2,839,185	A *	6/1958	Isaacs	.....	B65D 85/677 206/49
5,919,074	A *	7/1999	Honda	.....	A63H 3/50 206/779
D428,738	S *	8/2000	Brozak, Jr.	.....	D6/678.3
6,170,674	B1 *	1/2001	Caterinacci	.....	A47F 7/0042 211/41.1
D597,766	S *	8/2009	Nealon	.....	D6/683
D625,530	S *	10/2010	Robbins, III	.....	D6/683
D630,528	S *	1/2011	Dombrowski	.....	D9/415
D633,810	S *	3/2011	Jenkins	.....	D9/721
D660,701	S *	5/2012	Cox	.....	D9/455
8,220,680	B1 *	7/2012	Everson	.....	B60R 11/02 206/320
D668,545	S *	10/2012	Cox	.....	D9/455
8,522,970	B2 *	9/2013	Hsieh	.....	B65D 5/5021 206/320
D702,115	S *	4/2014	Partrat	.....	D9/415
D703,754	S *	4/2014	Logue	.....	D20/1
D704,047	S *	5/2014	Hyma	.....	D9/414
D704,569	S *	5/2014	Partrat	.....	D9/415
D706,349	S *	6/2014	Logue	.....	D20/1
D706,350	S *	6/2014	Logue	.....	D20/1
D727,143	S *	4/2015	Gomez	.....	D14/251
D729,518	S *	5/2015	Neusidl	.....	D3/265
D730,168	S *	5/2015	Deshpande	.....	D9/415
D742,215	S *	11/2015	Deshpande	.....	D9/415
D760,588	S *	7/2016	Cheng	.....	D9/414
D774,884	S *	12/2016	Deshpande	.....	D9/415
D783,395	S *	4/2017	Wang	.....	D9/418

\* cited by examiner

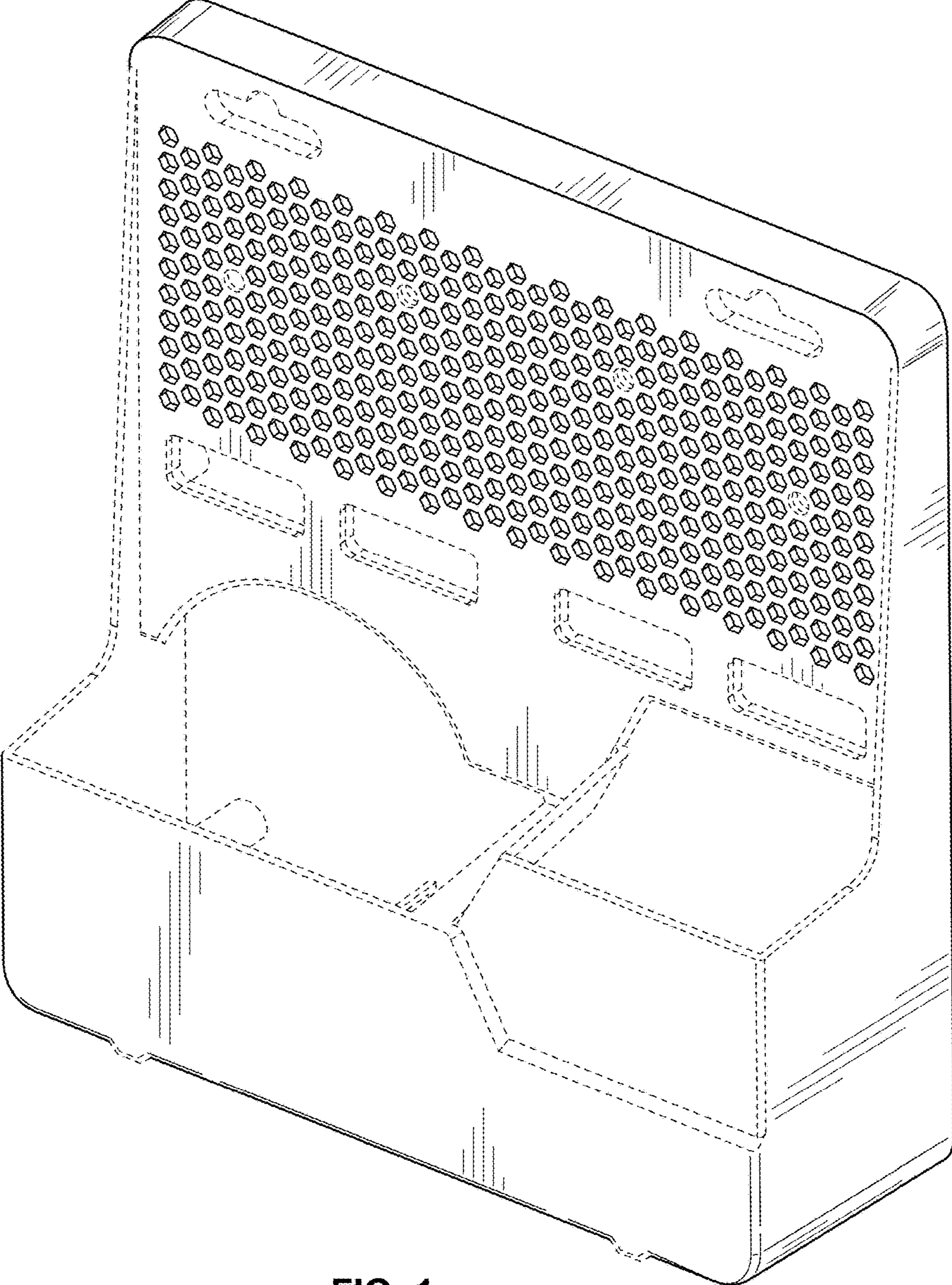

FIG. 1

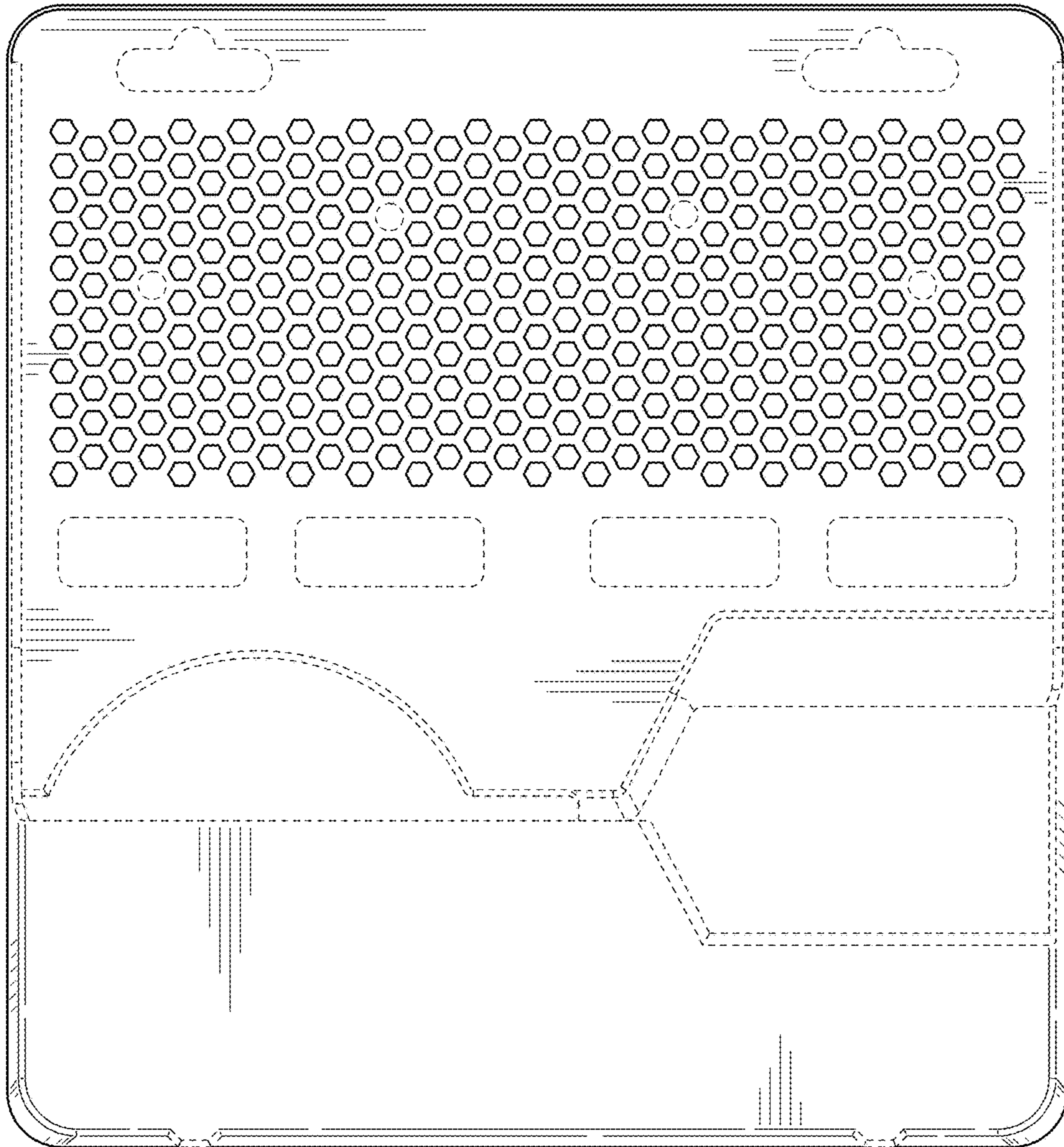

FIG. 2

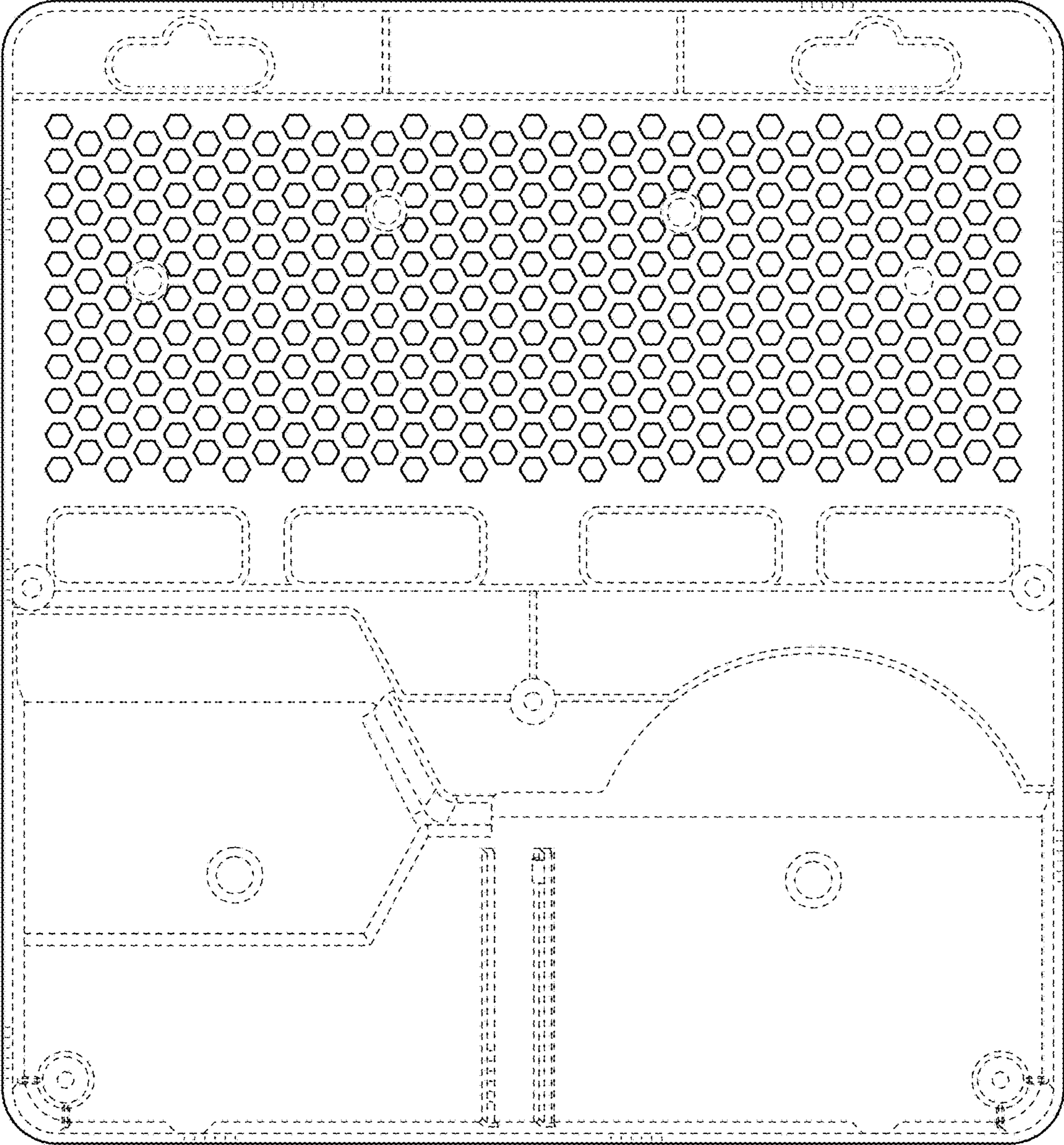

FIG. 3

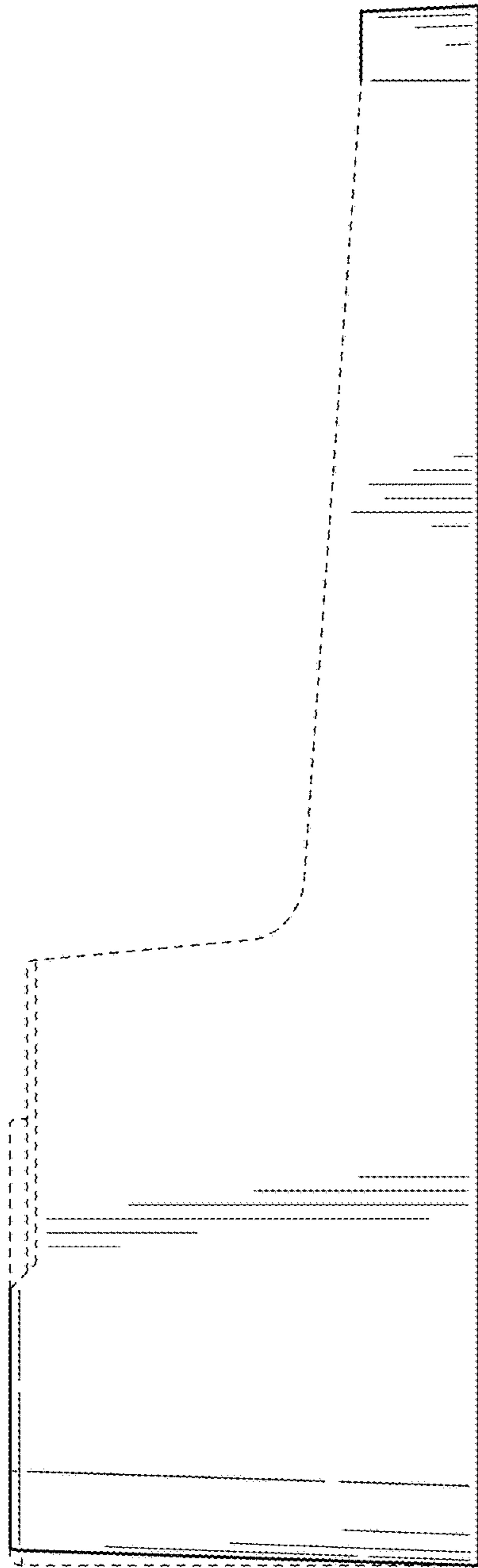

FIG. 4

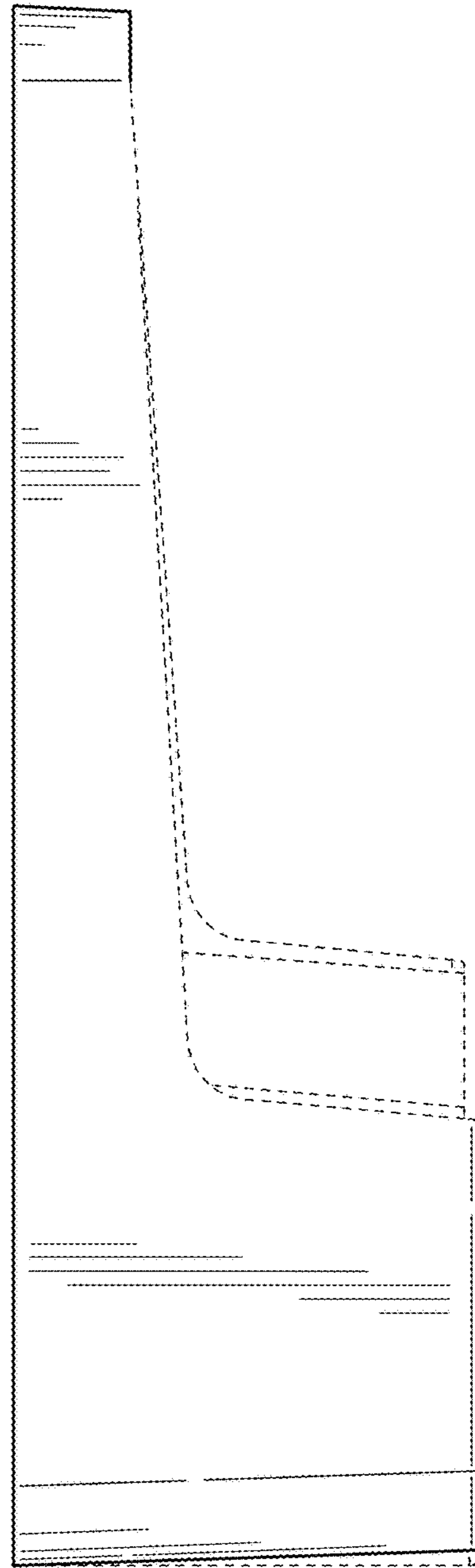

FIG. 5

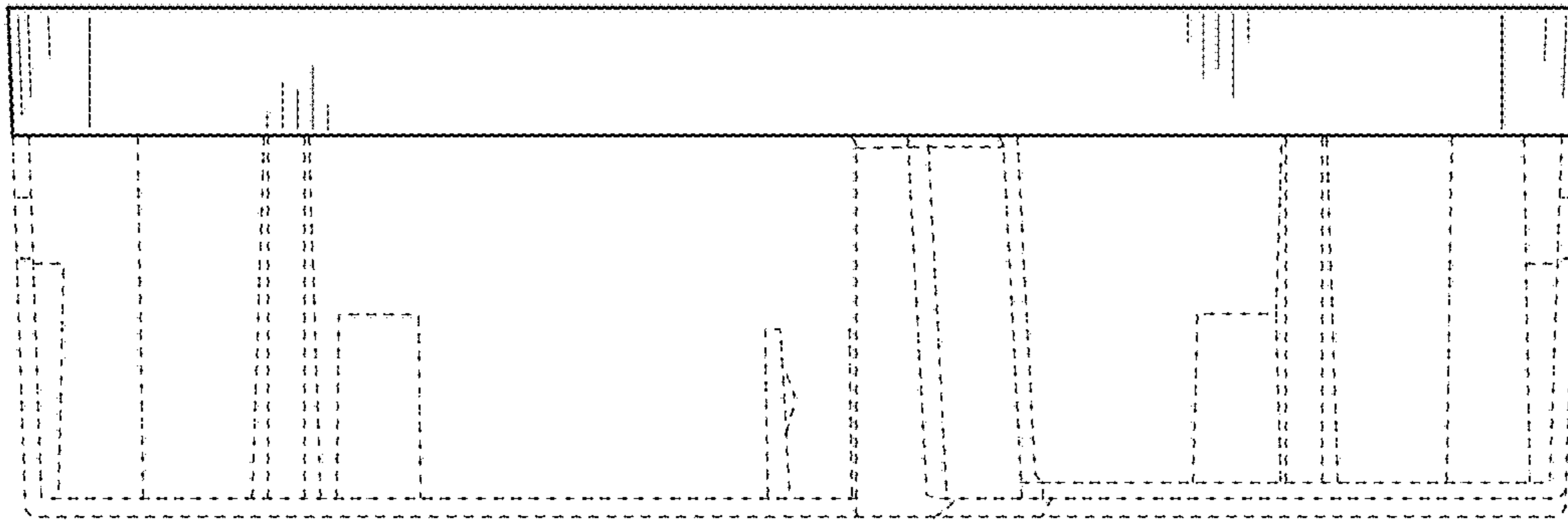

FIG. 6

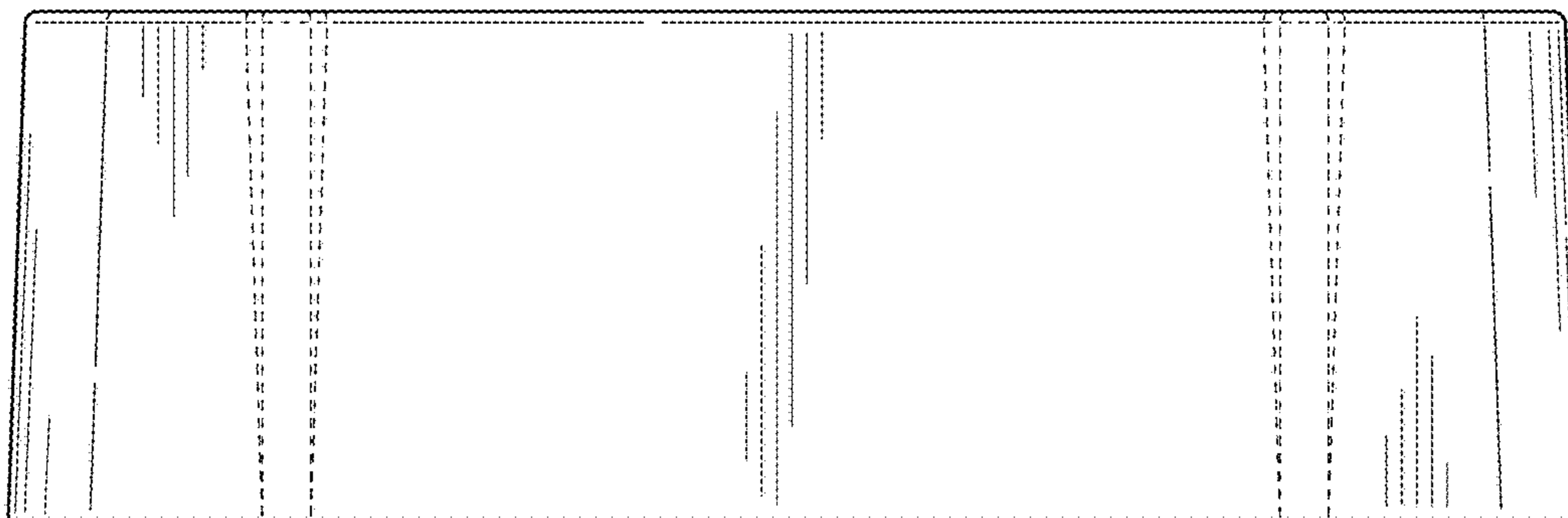

FIG. 7

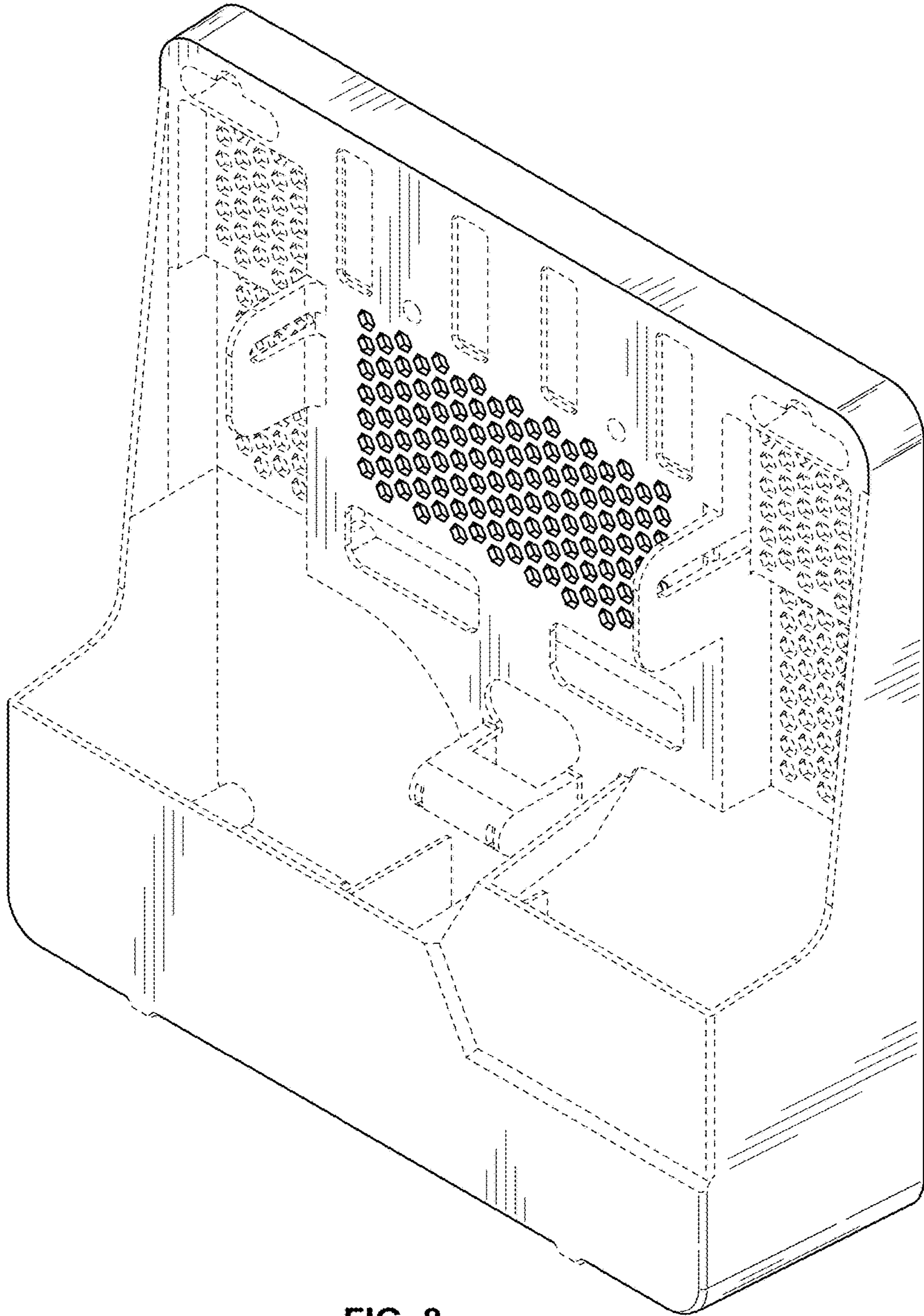

FIG. 8



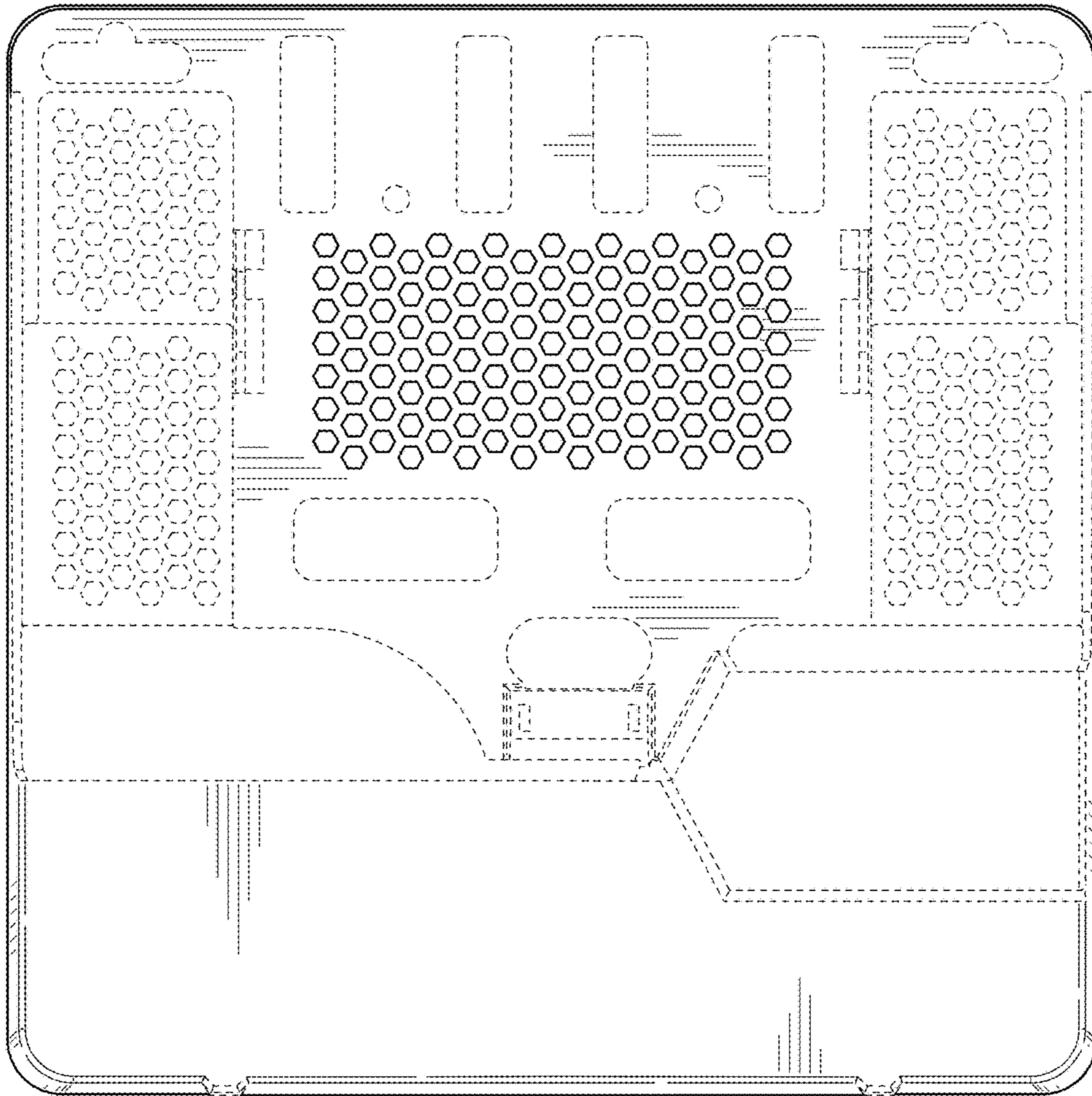

FIG. 9

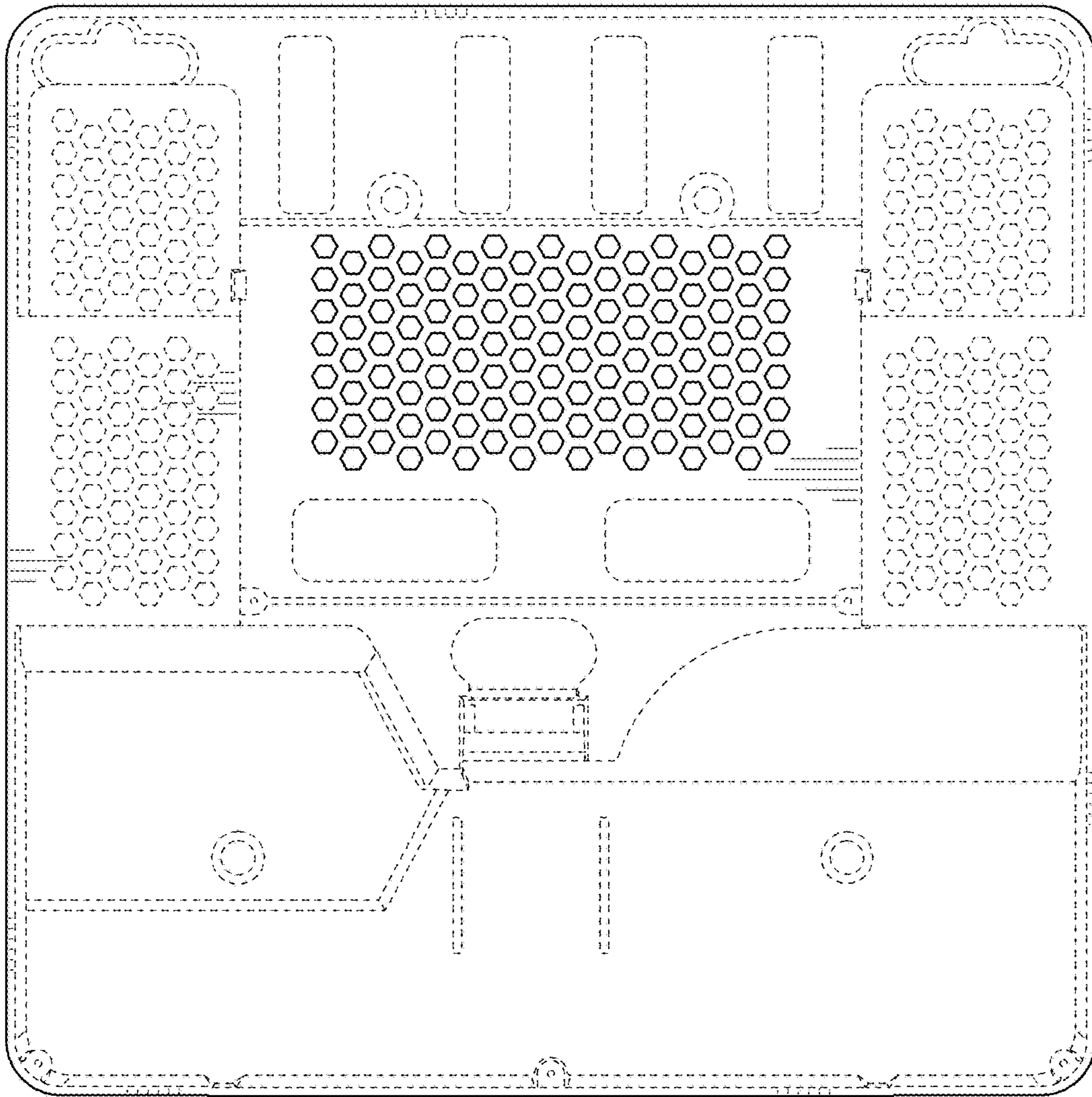

FIG. 10

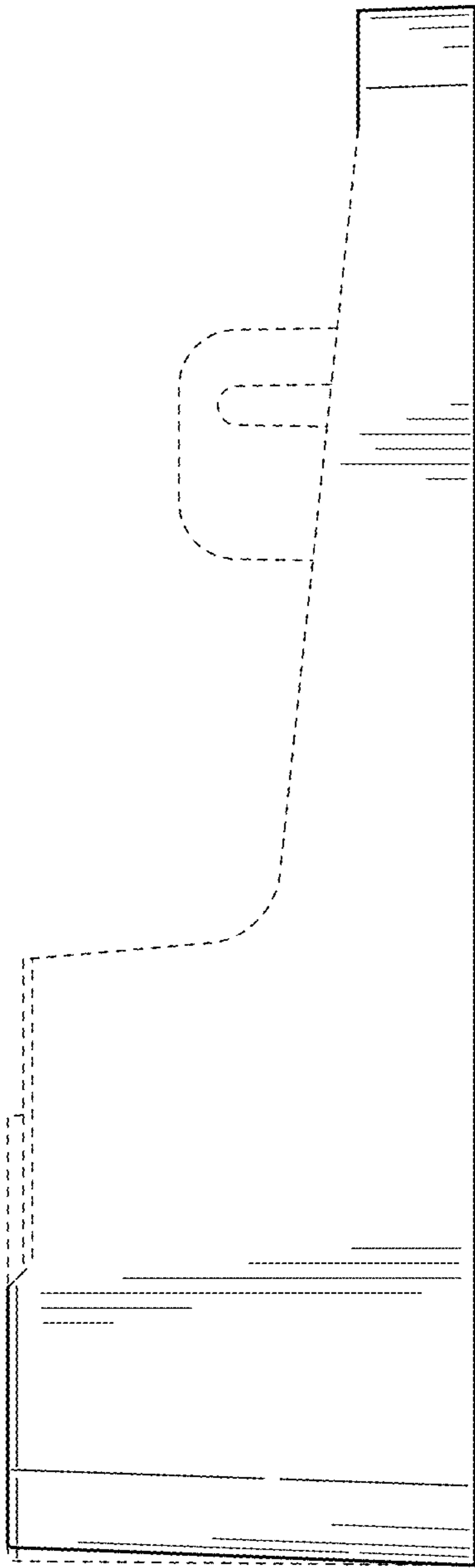

FIG. 11

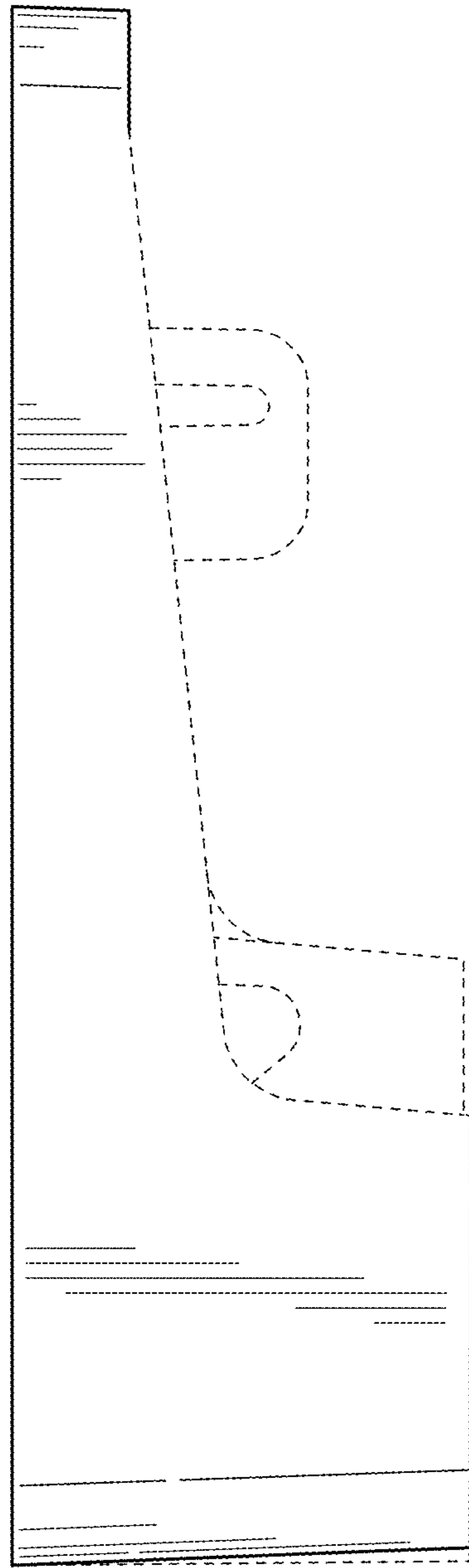

FIG. 12

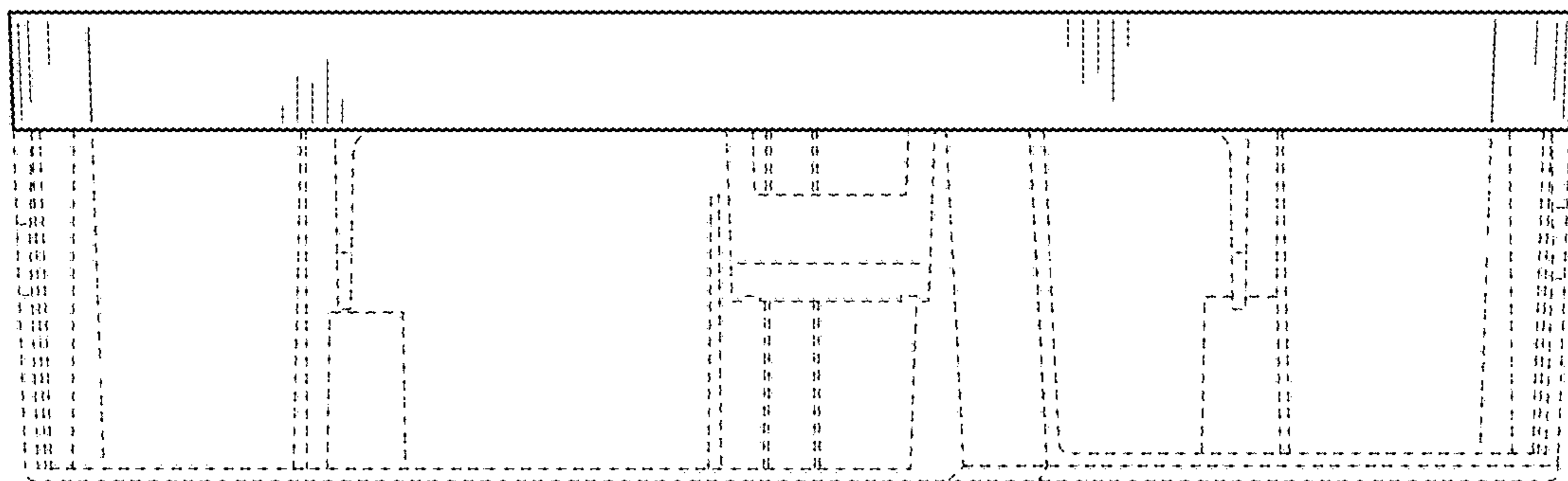

FIG. 13

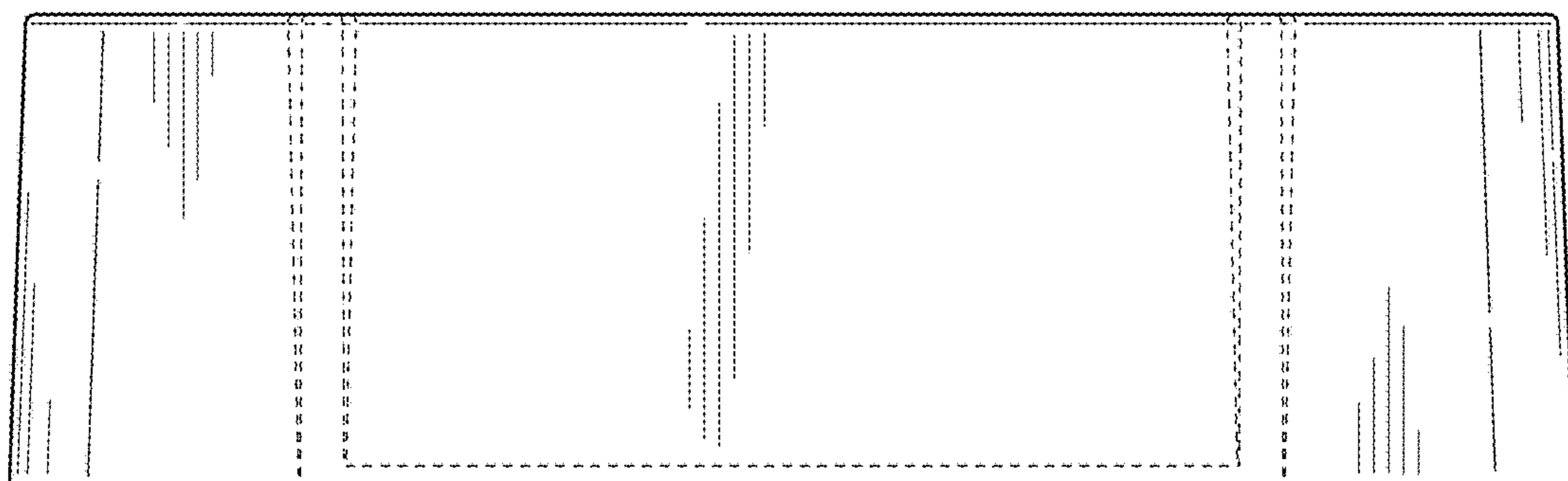

FIG. 14

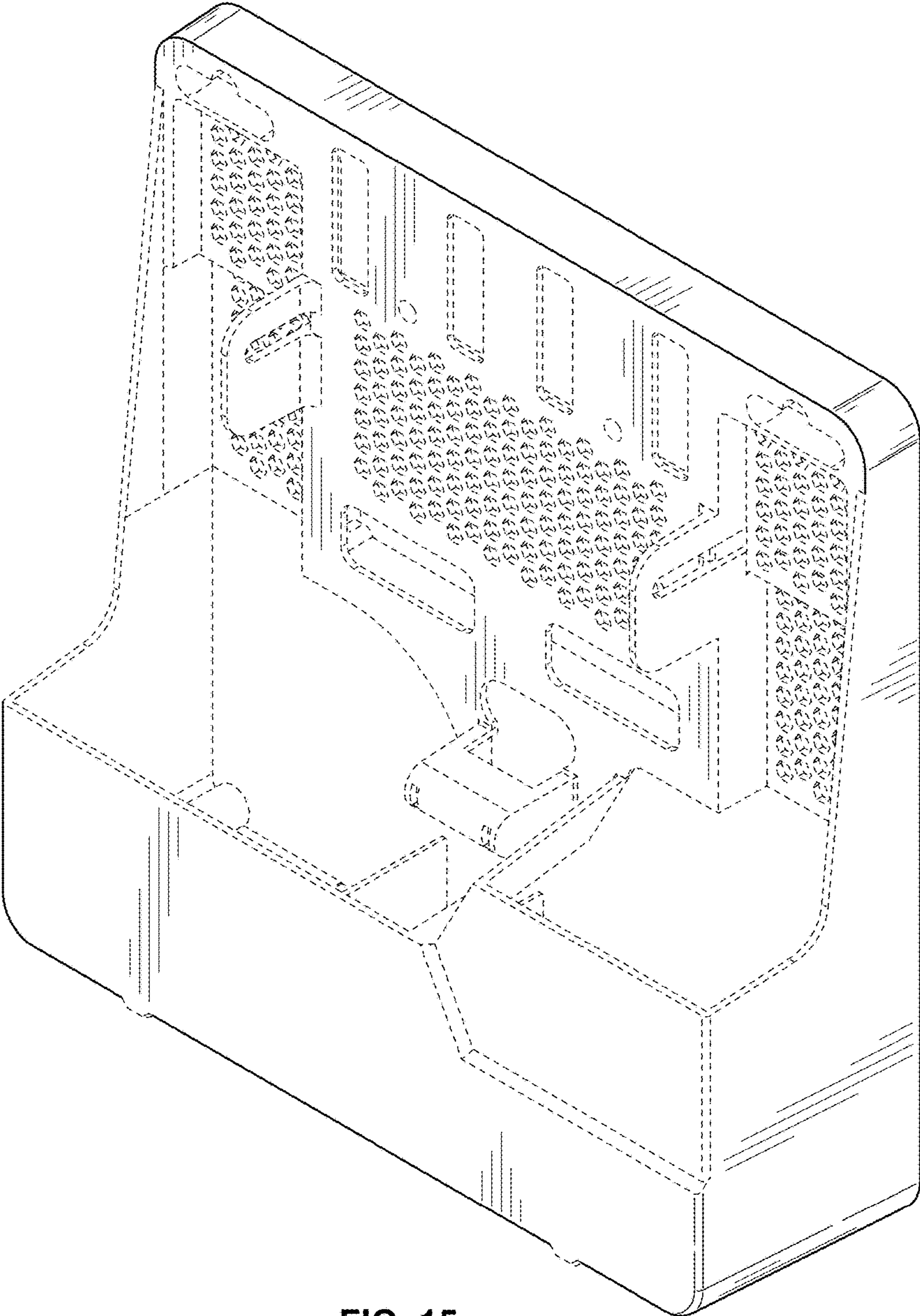

FIG. 15

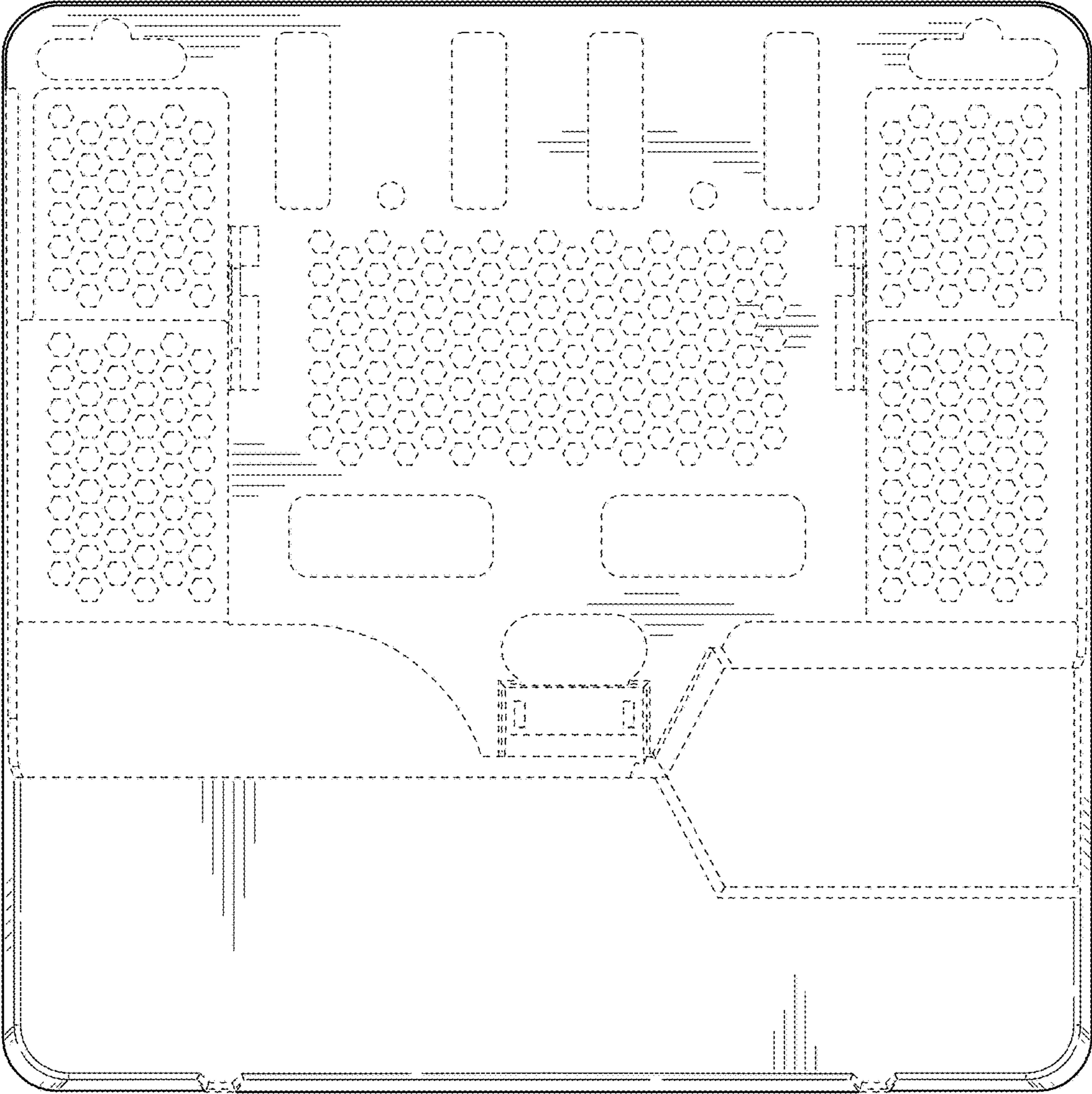

FIG. 16

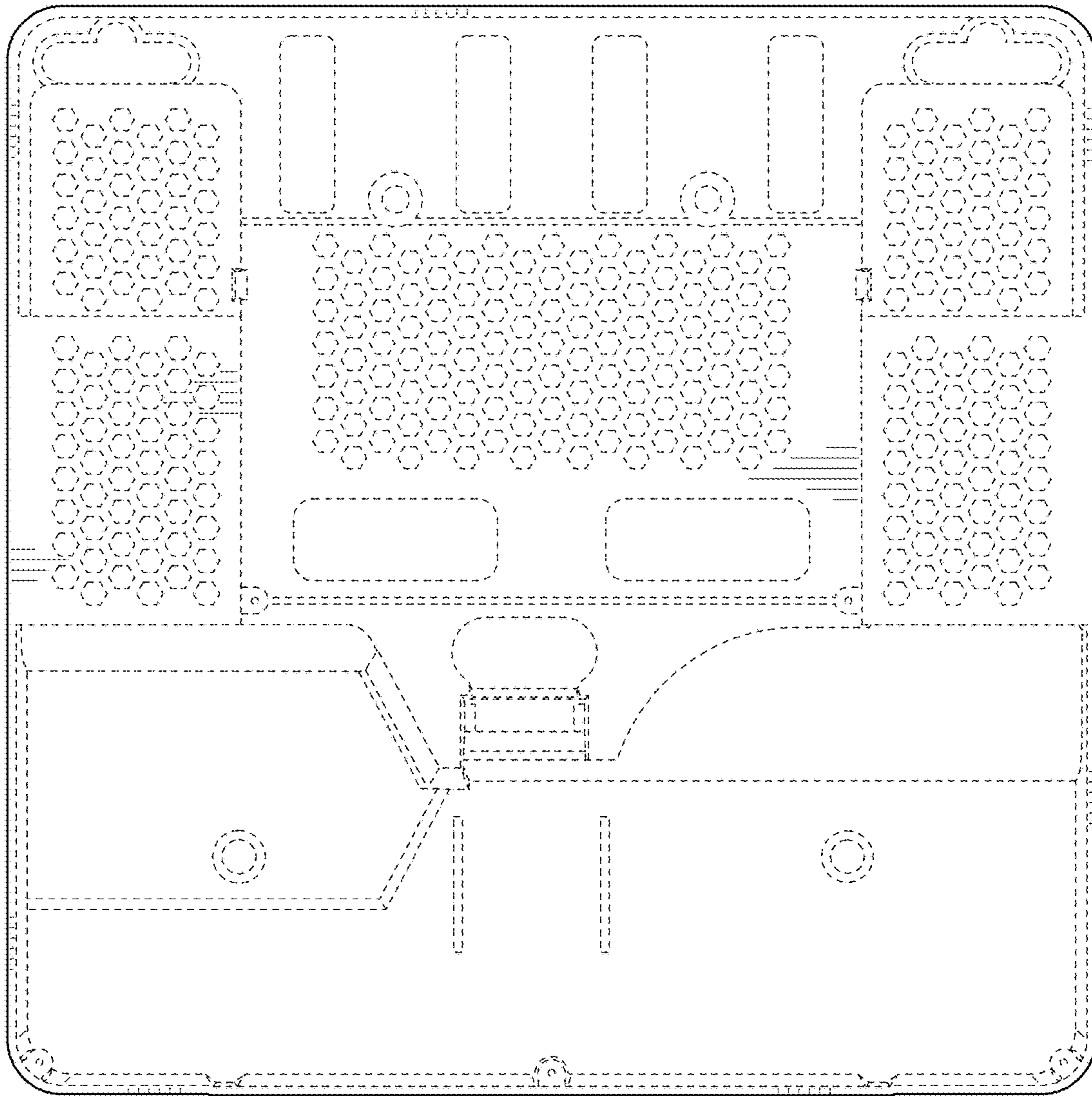

FIG. 17

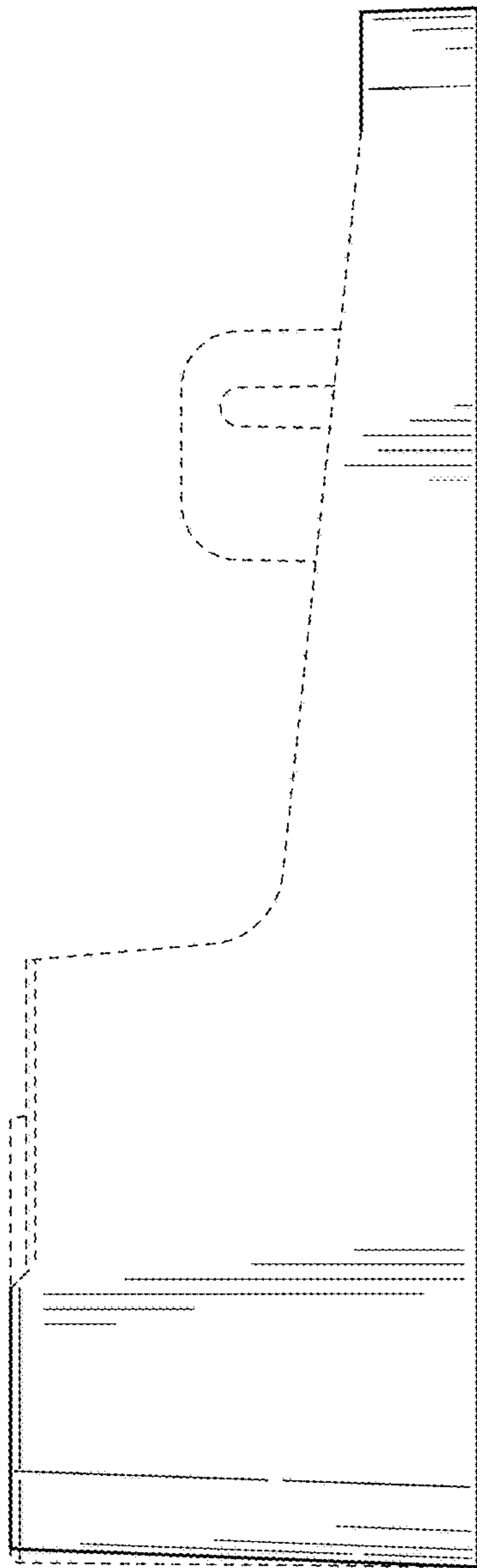

FIG. 18

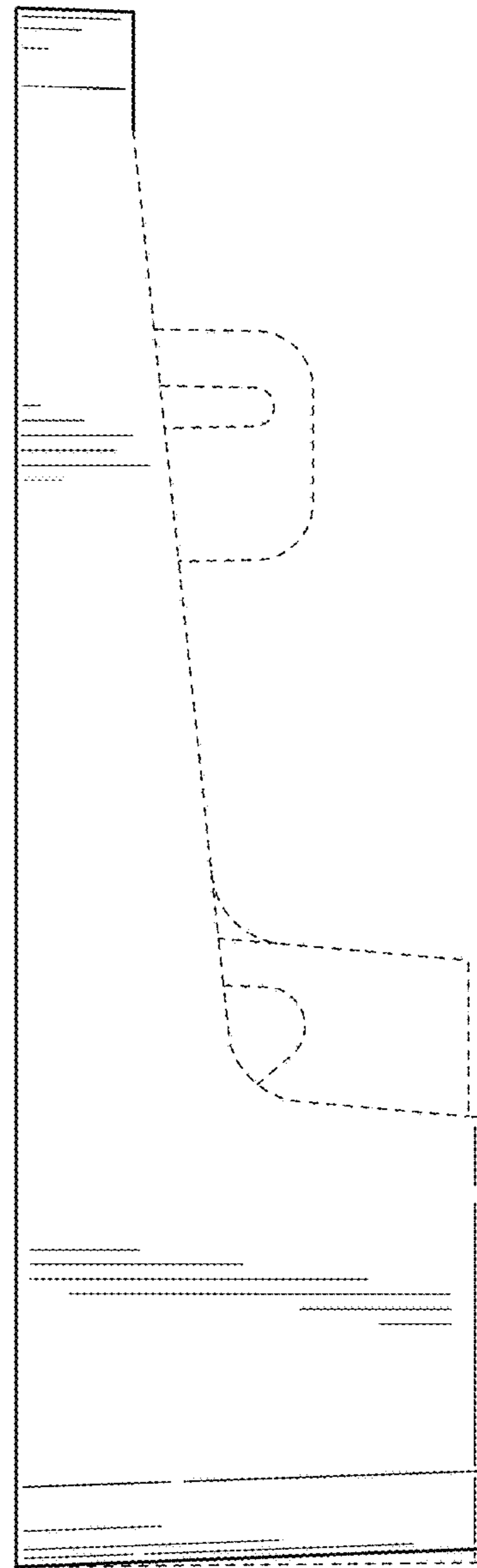

FIG. 19



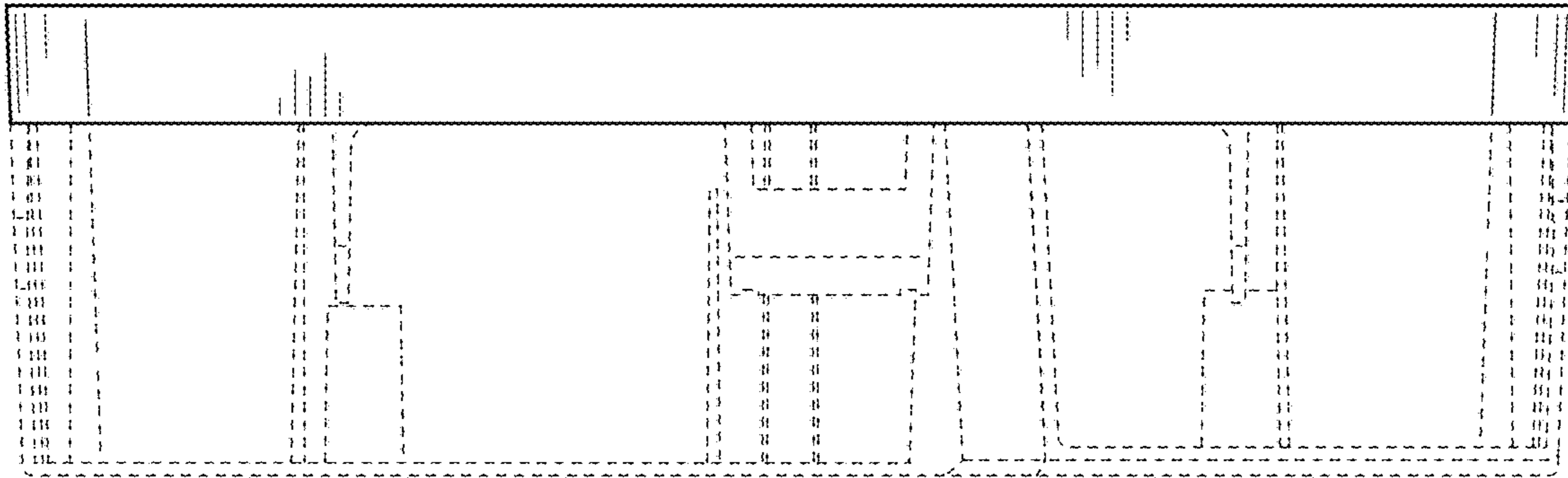

FIG. 20

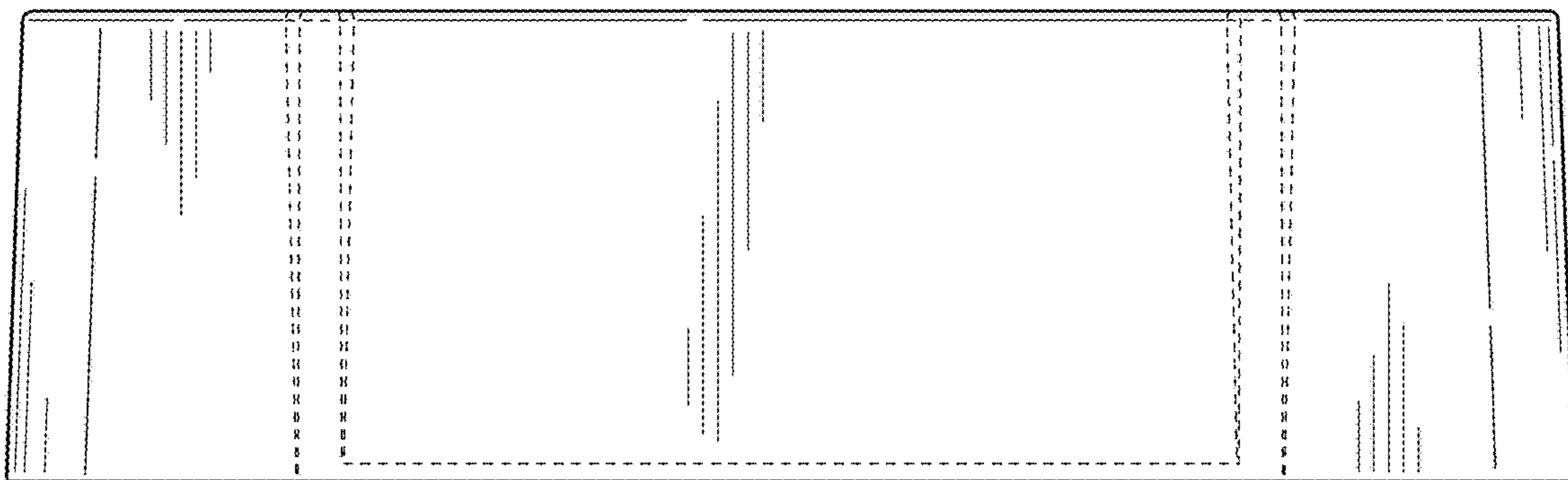

FIG. 21

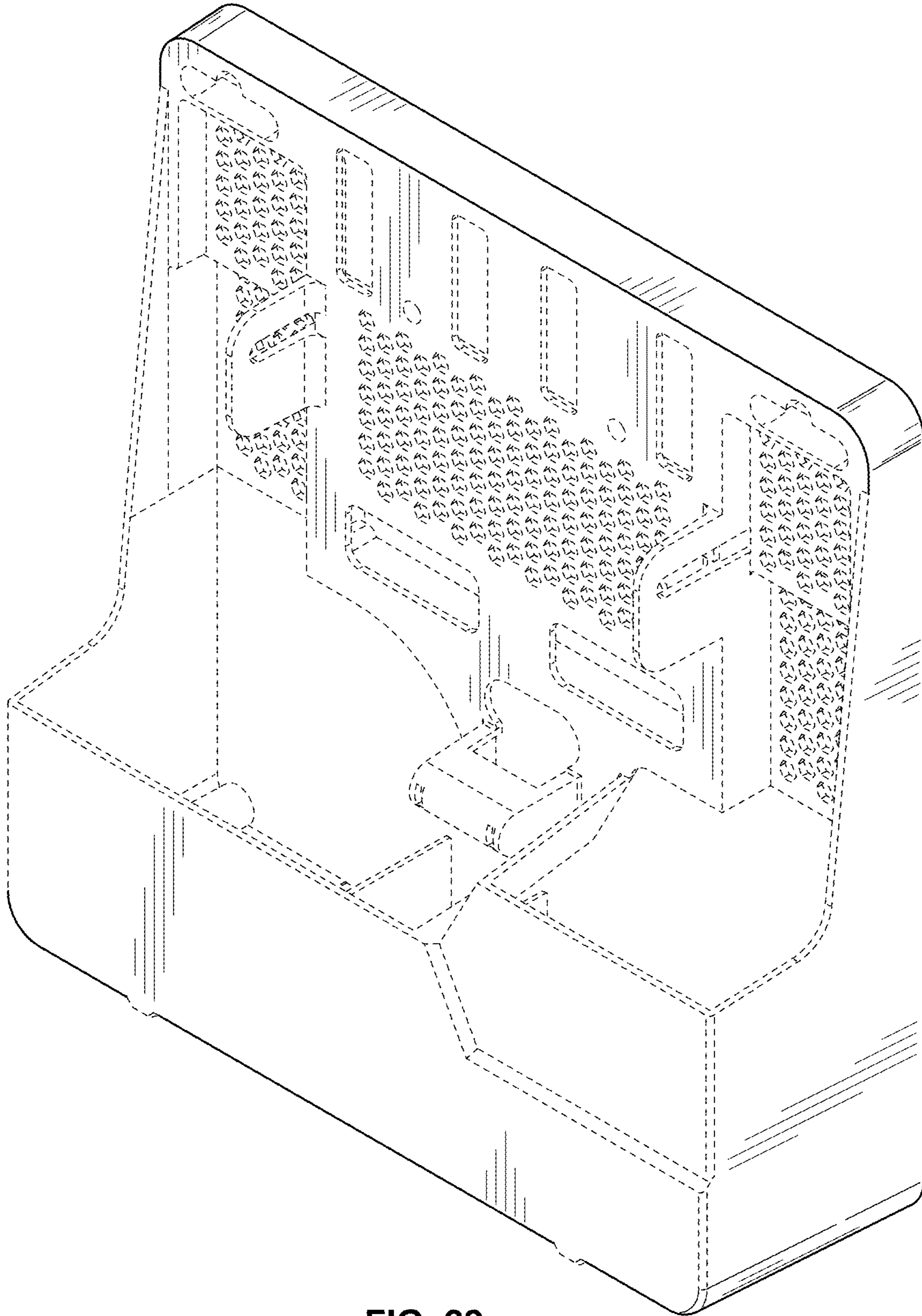

FIG. 22

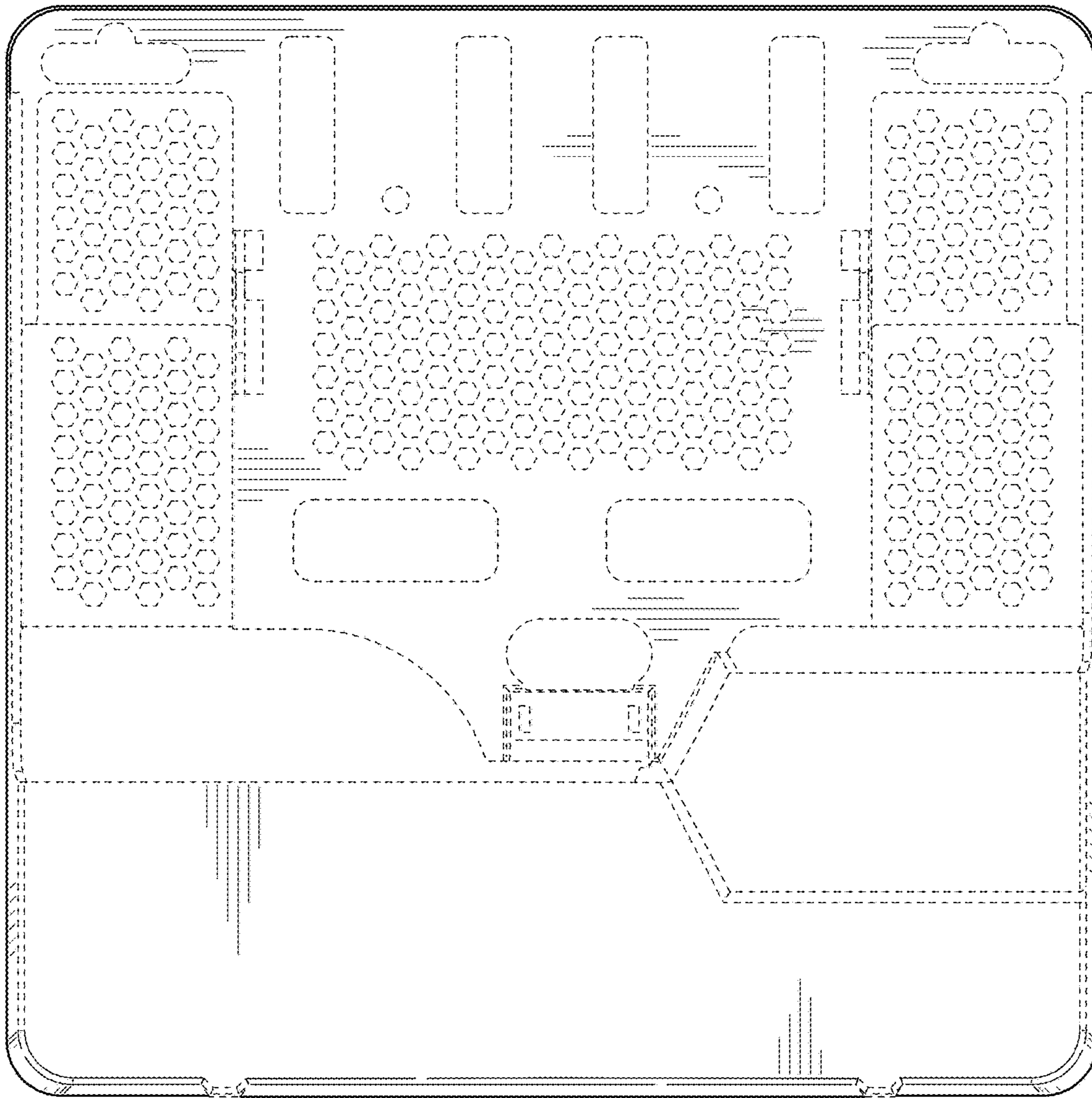

FIG. 23

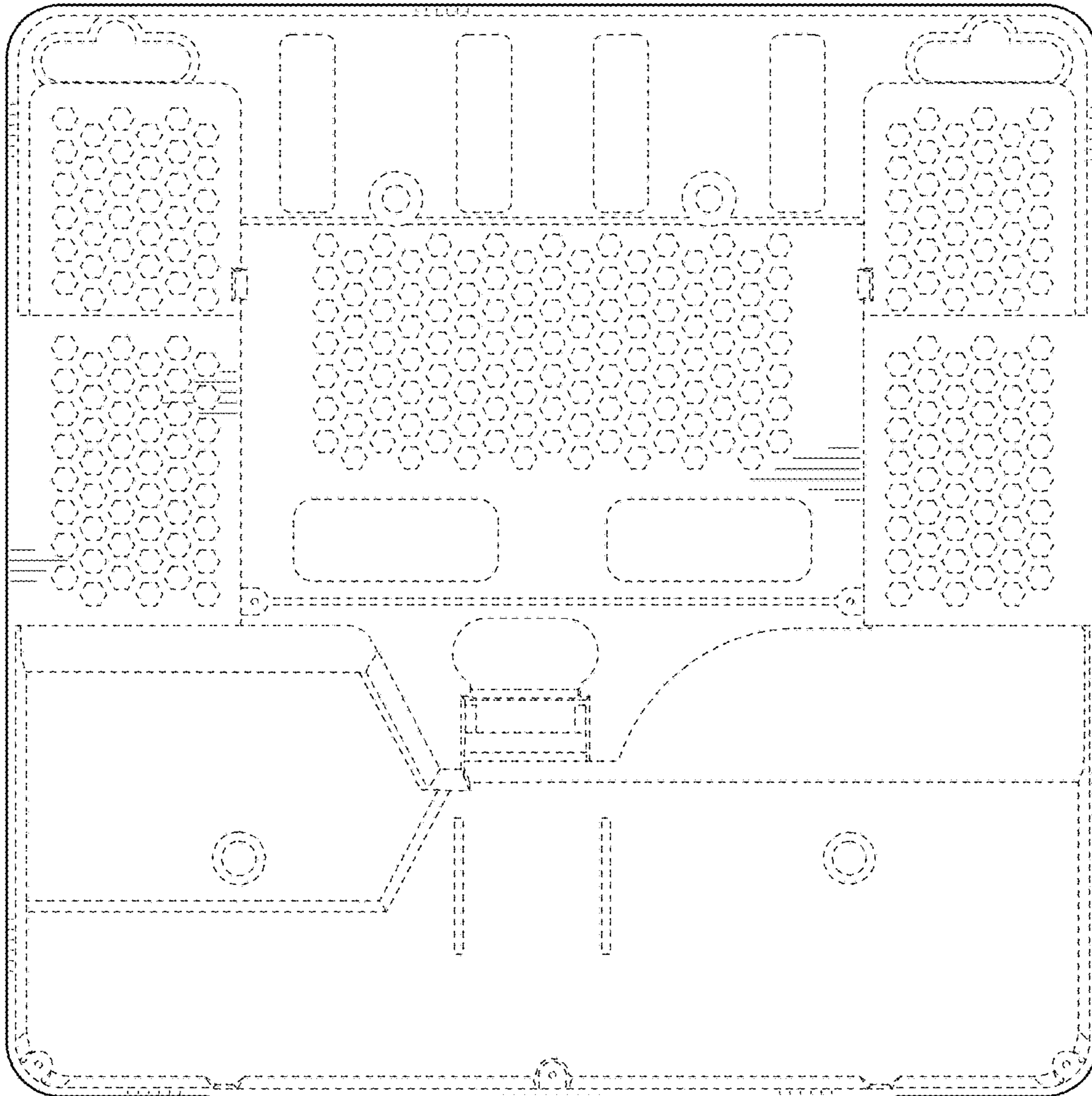

FIG. 24

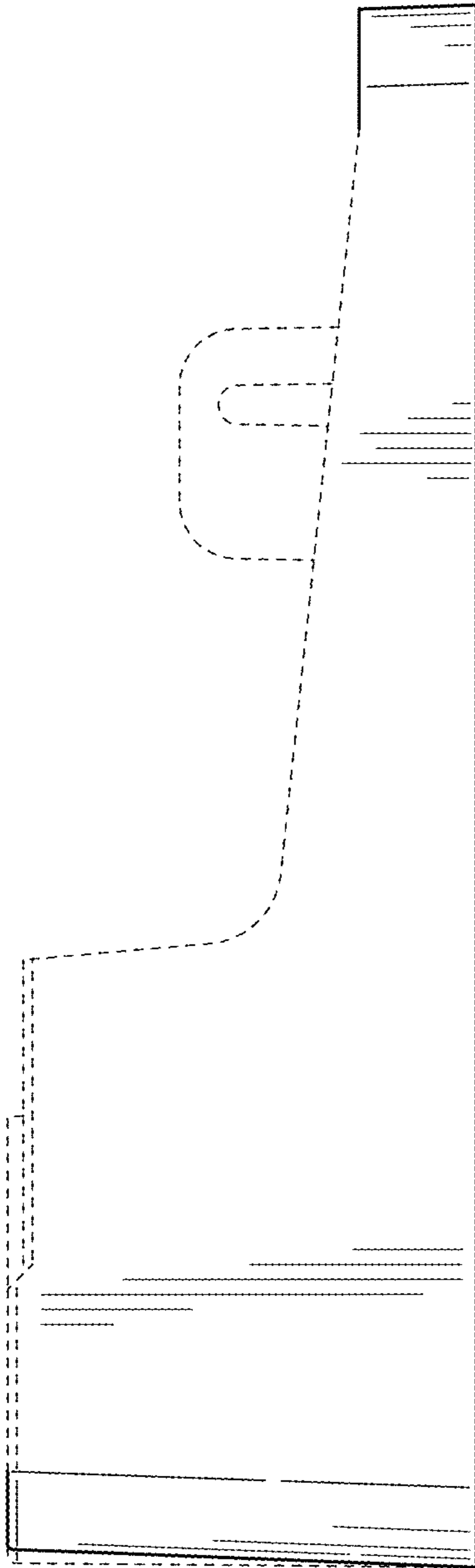

FIG. 25

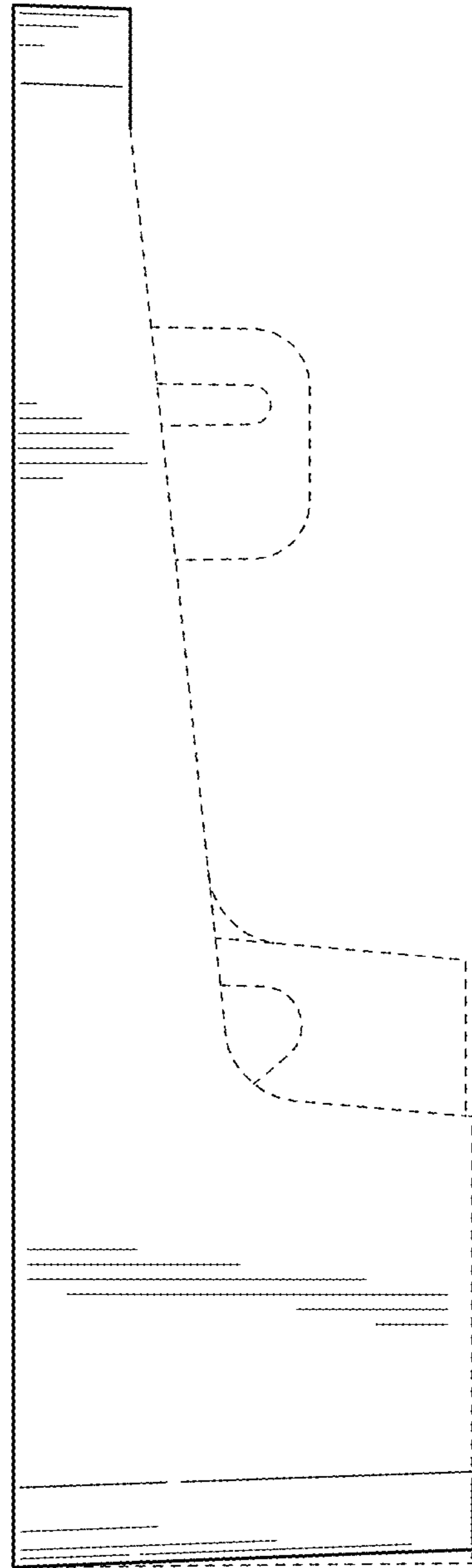

FIG. 26

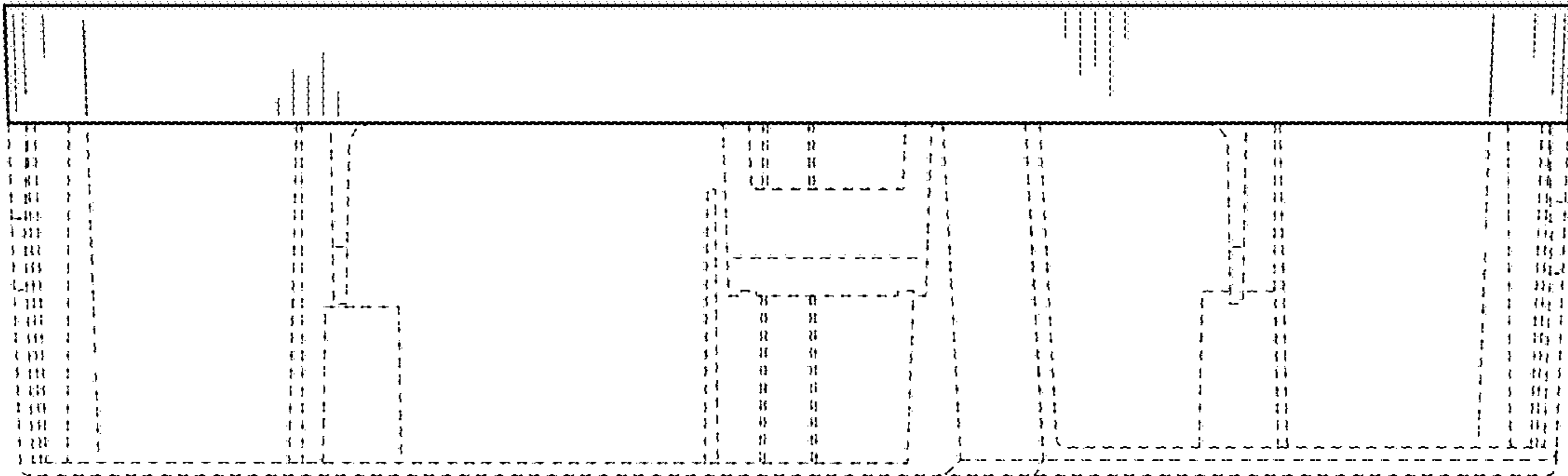

FIG. 27

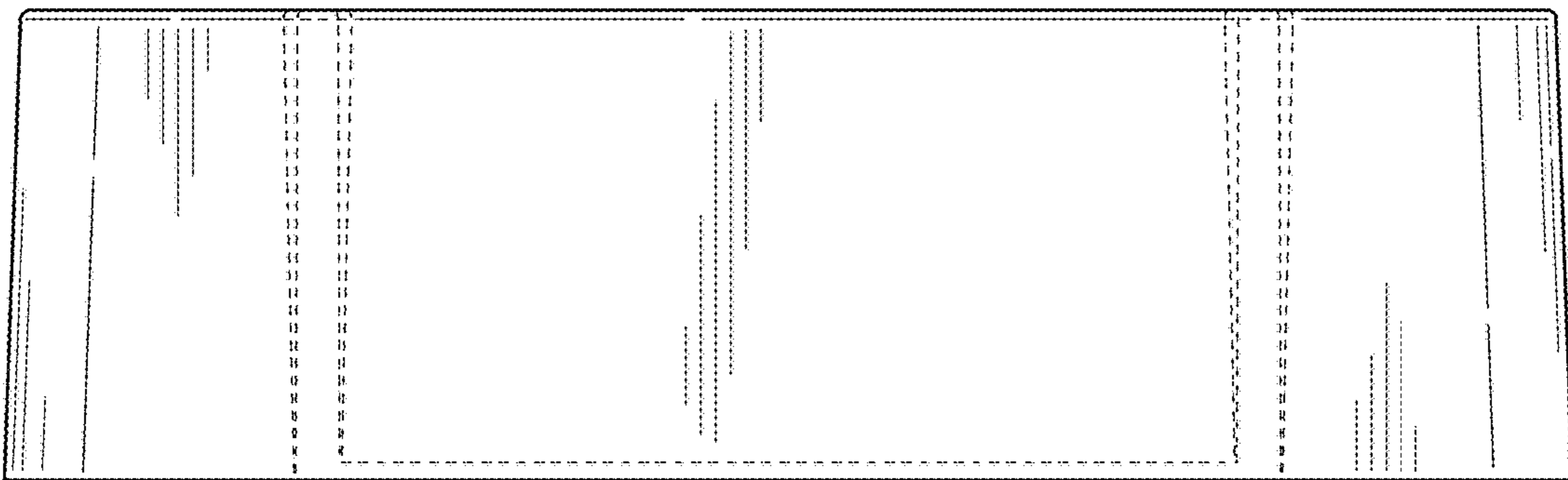

FIG. 28

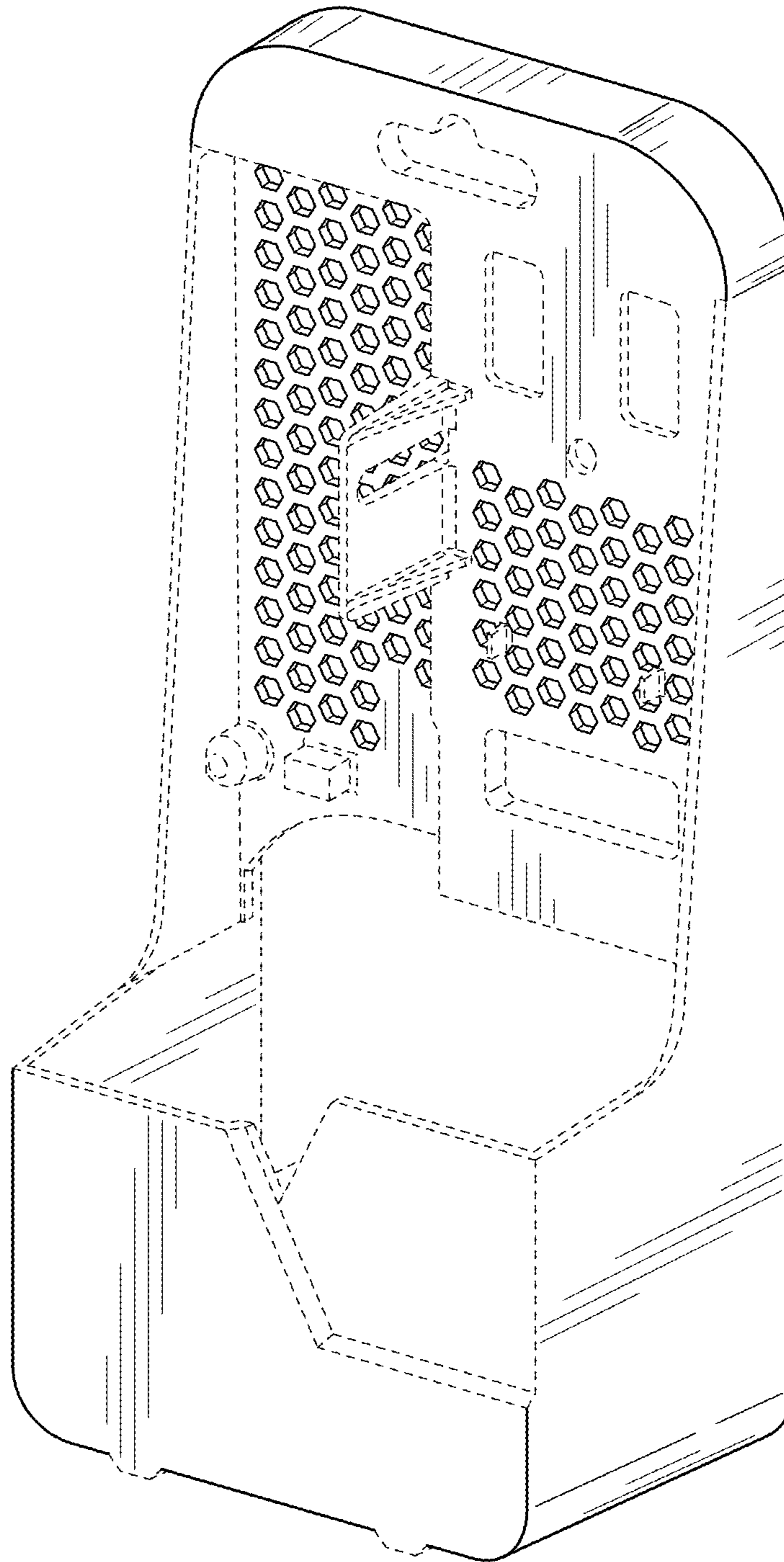

FIG. 29

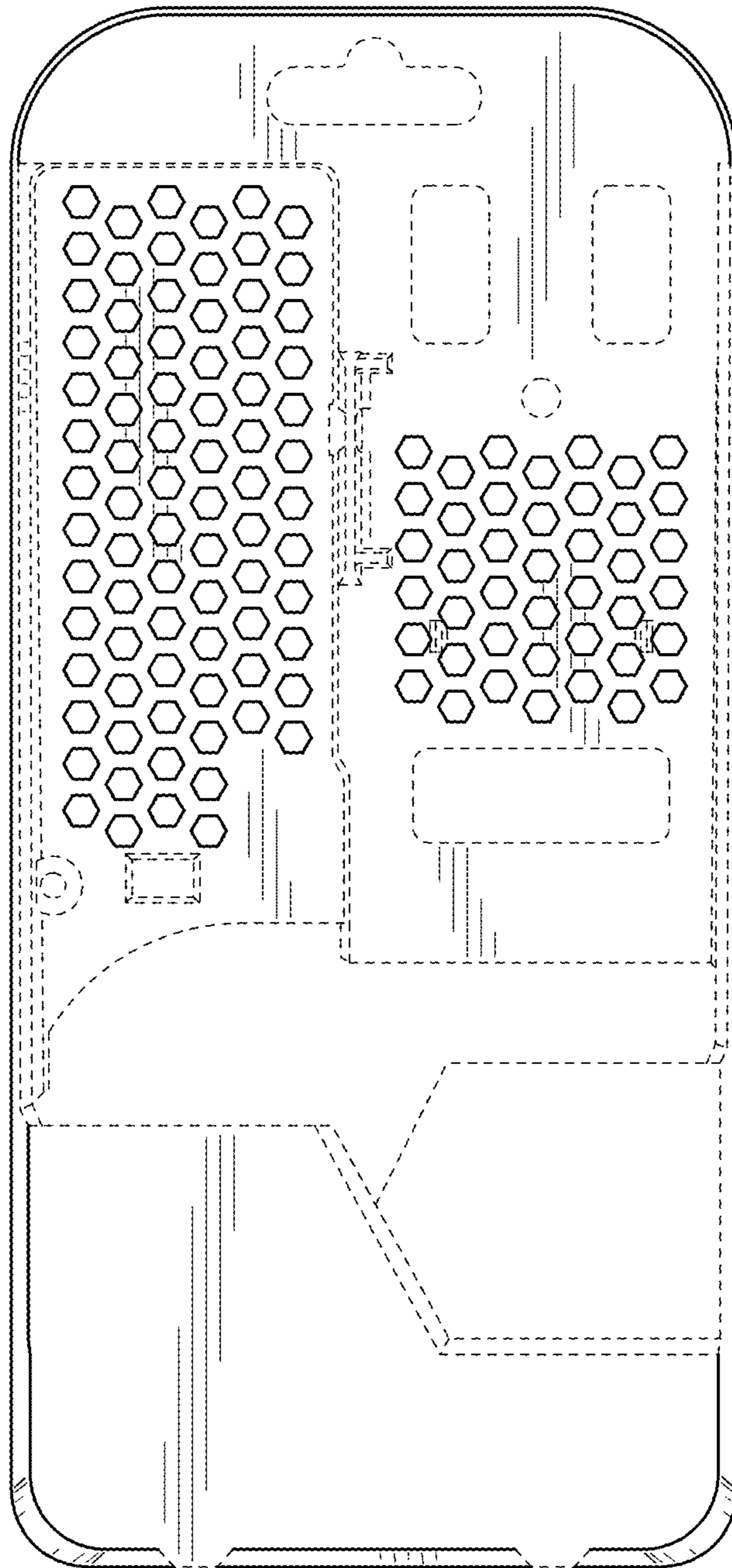

FIG. 30



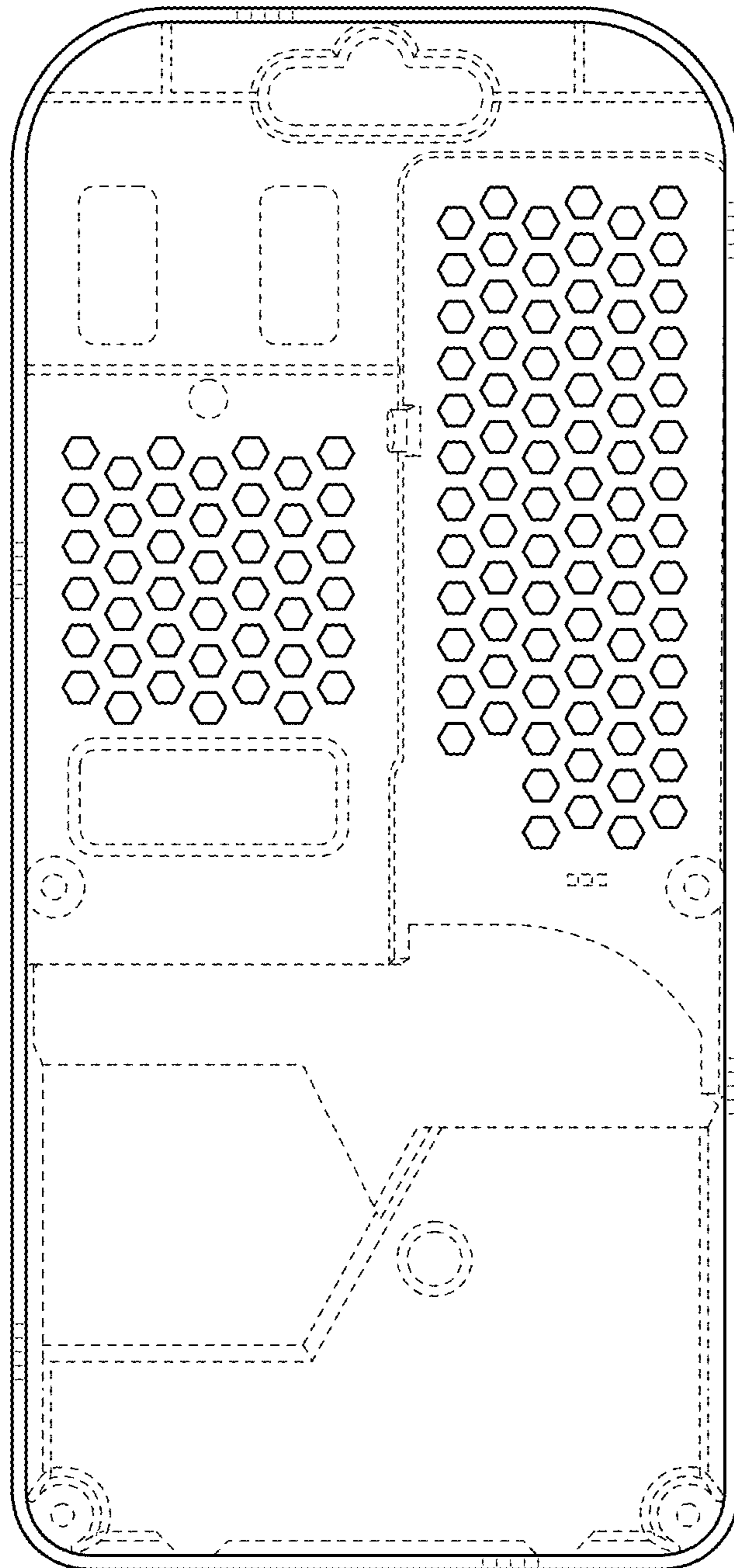

FIG. 31

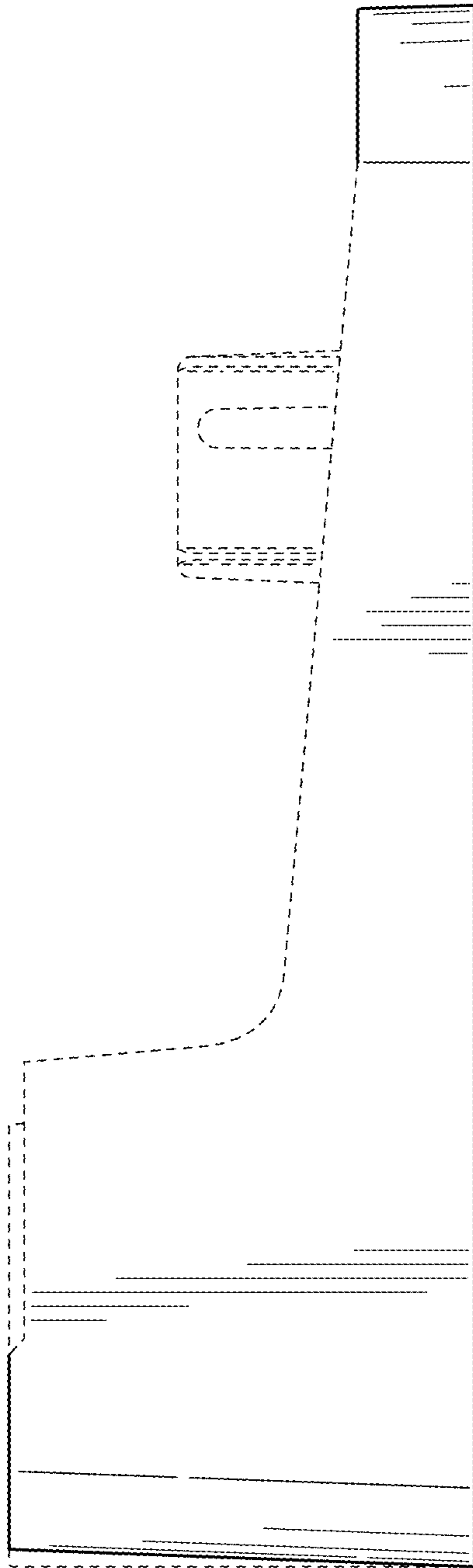

FIG. 32

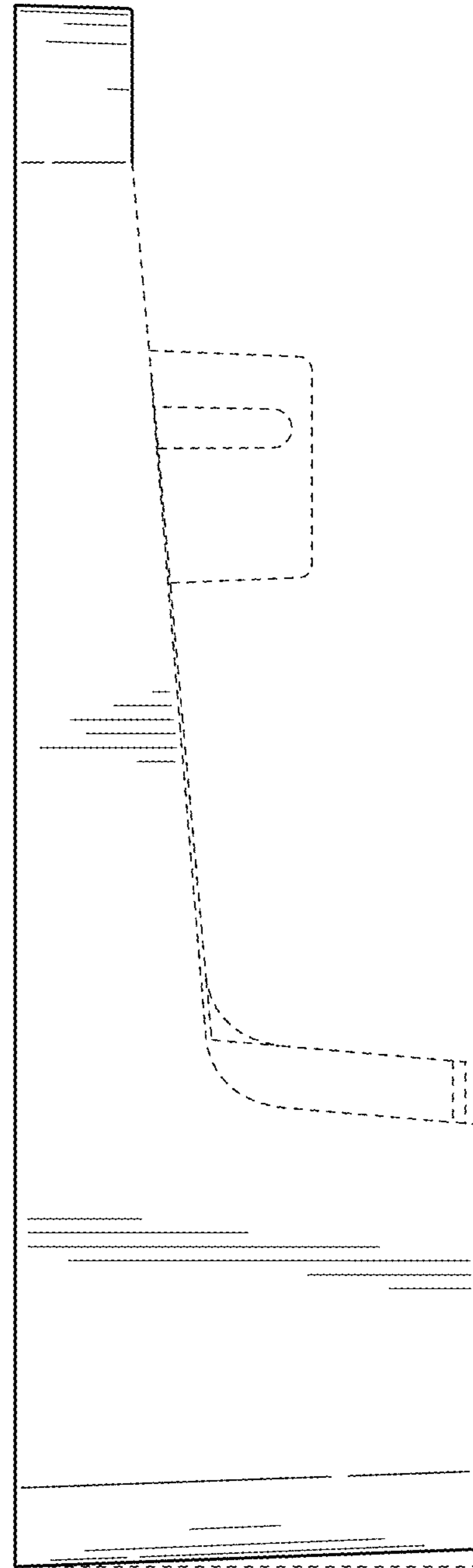

FIG. 33

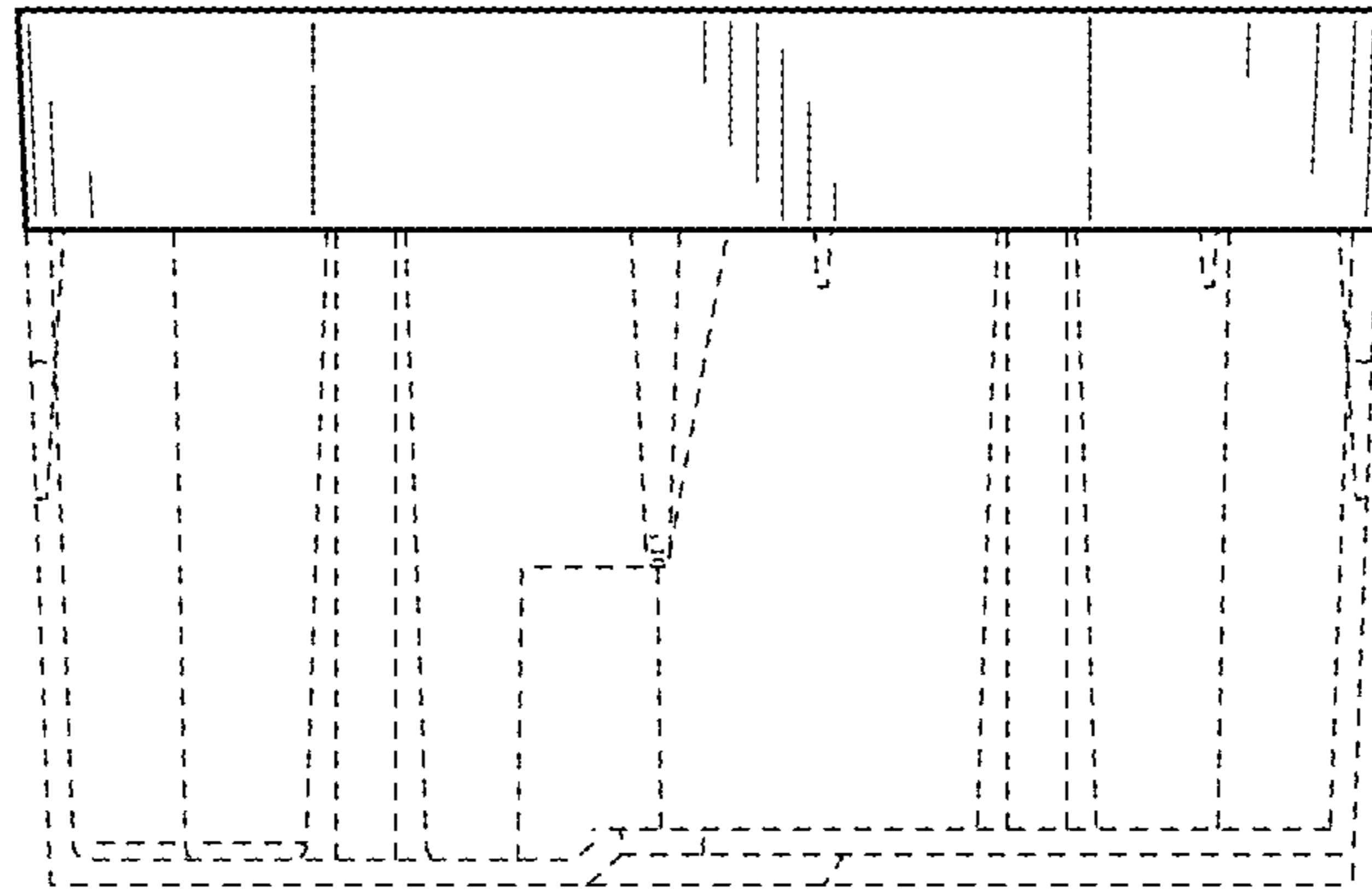

FIG. 34

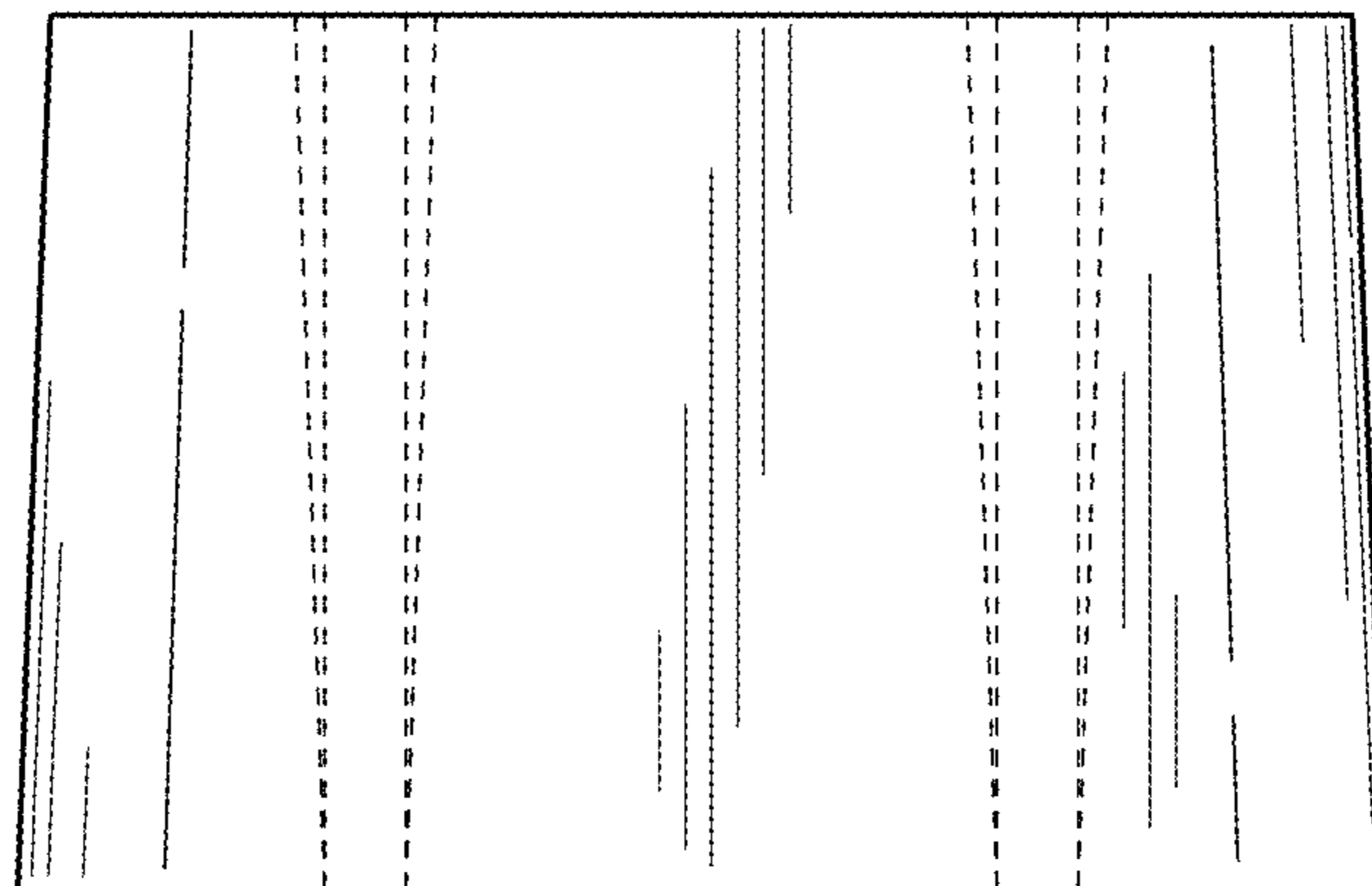

FIG. 35

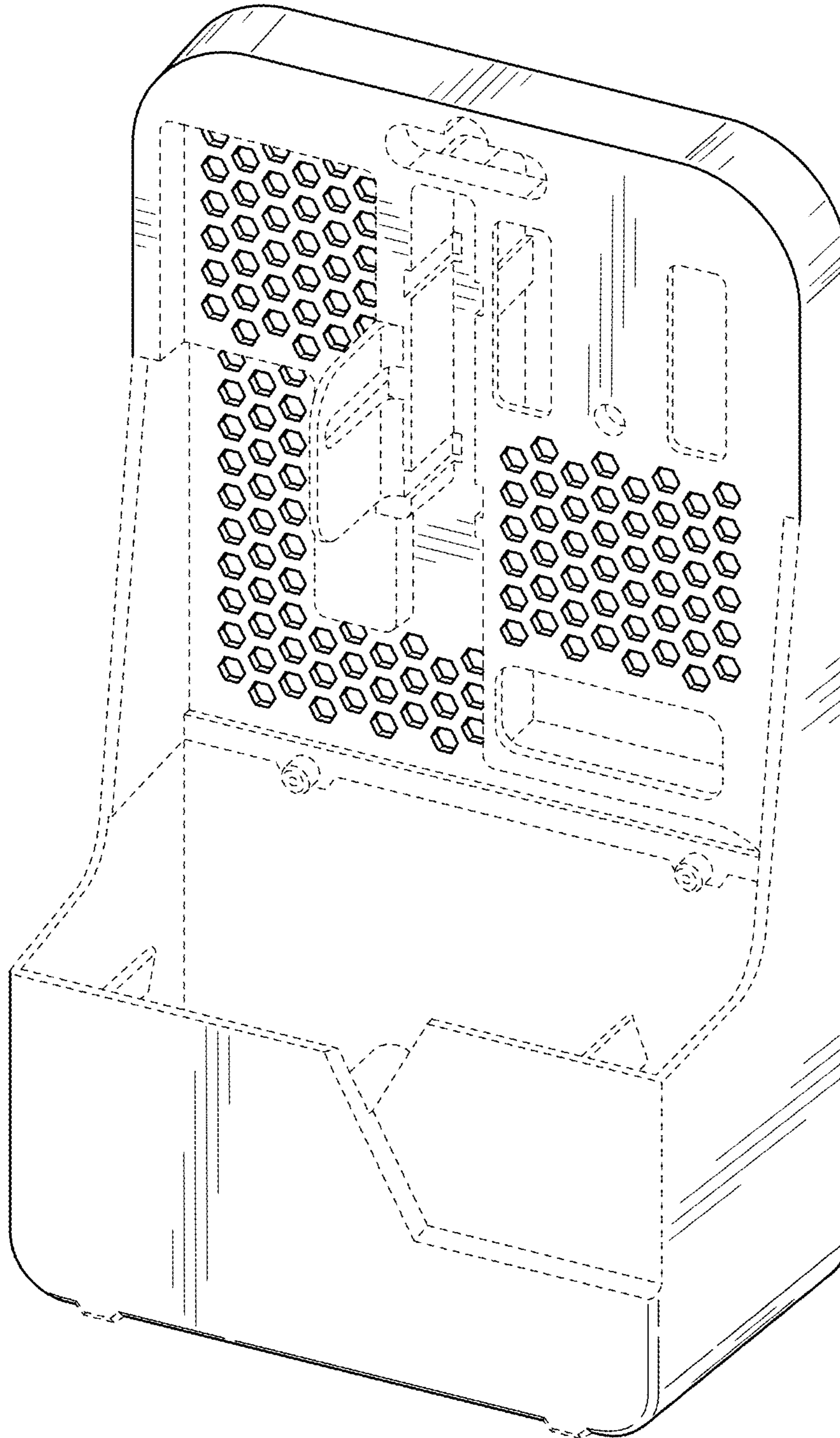

FIG. 36

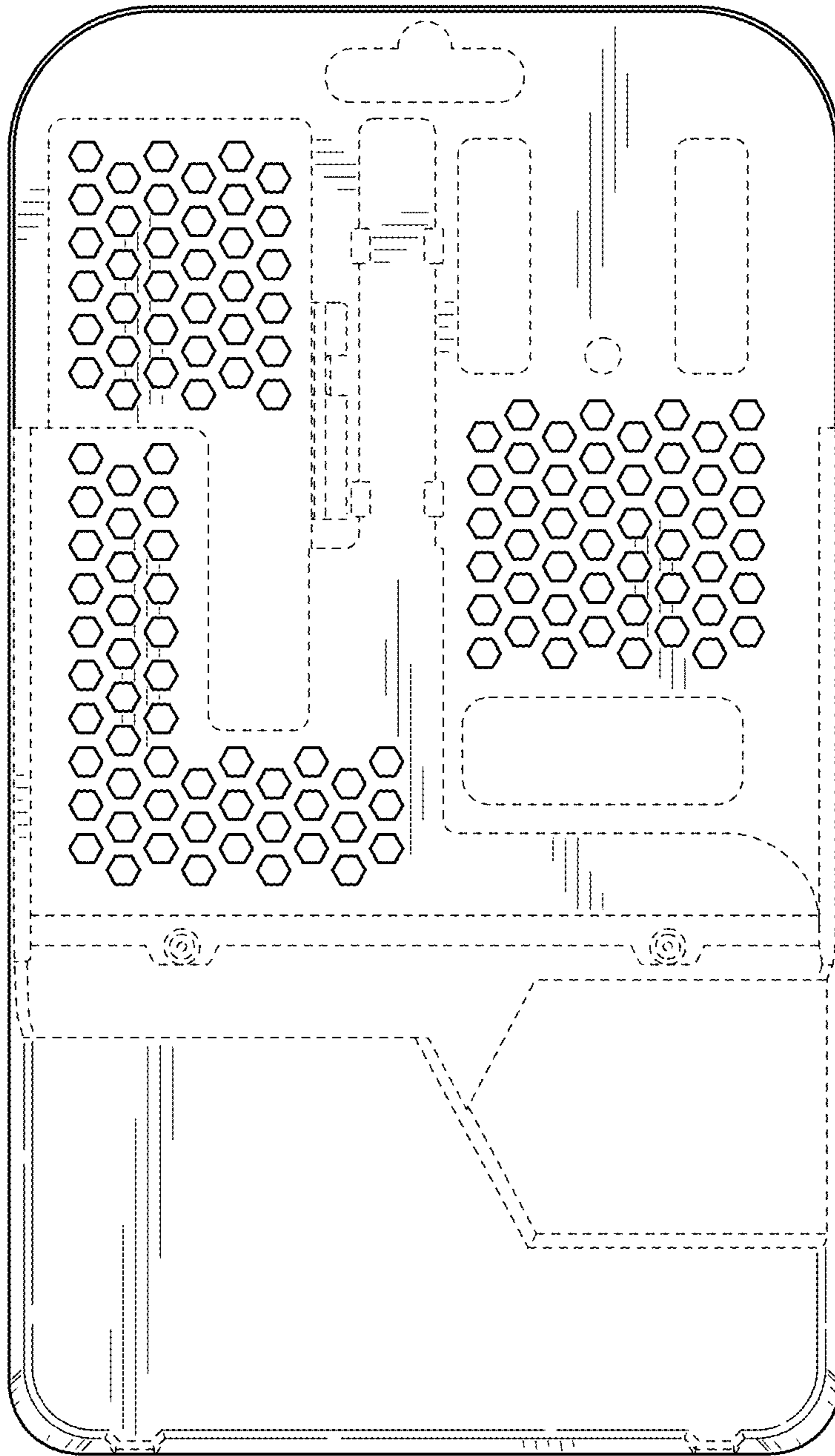

FIG. 37

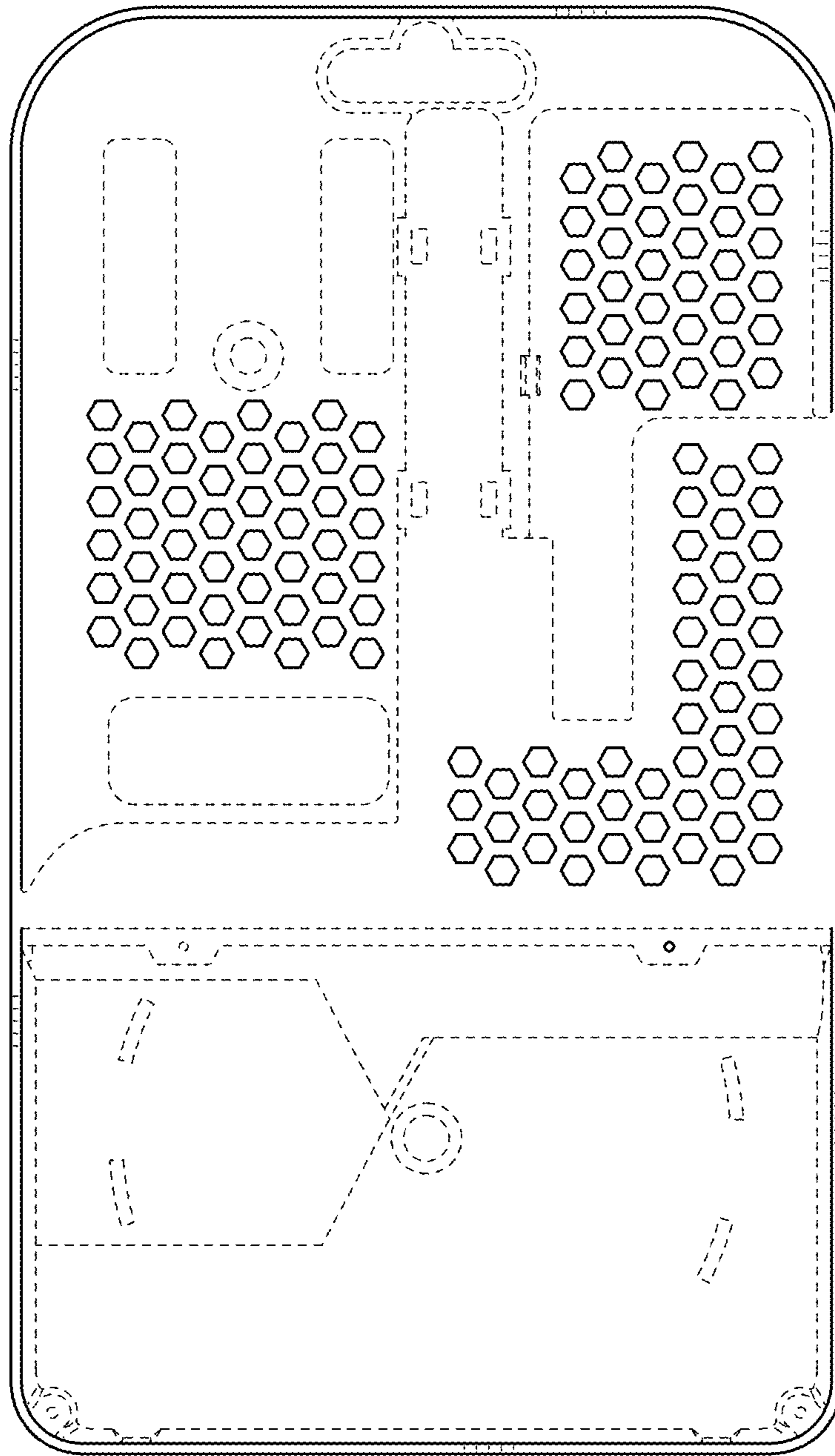

FIG. 38

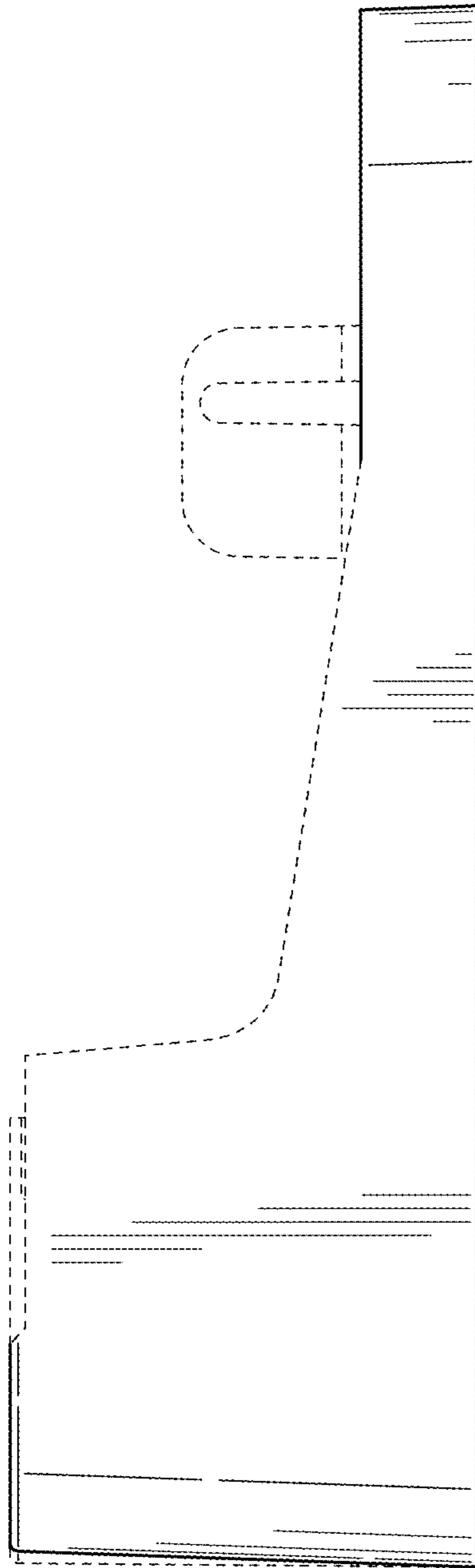

FIG. 39

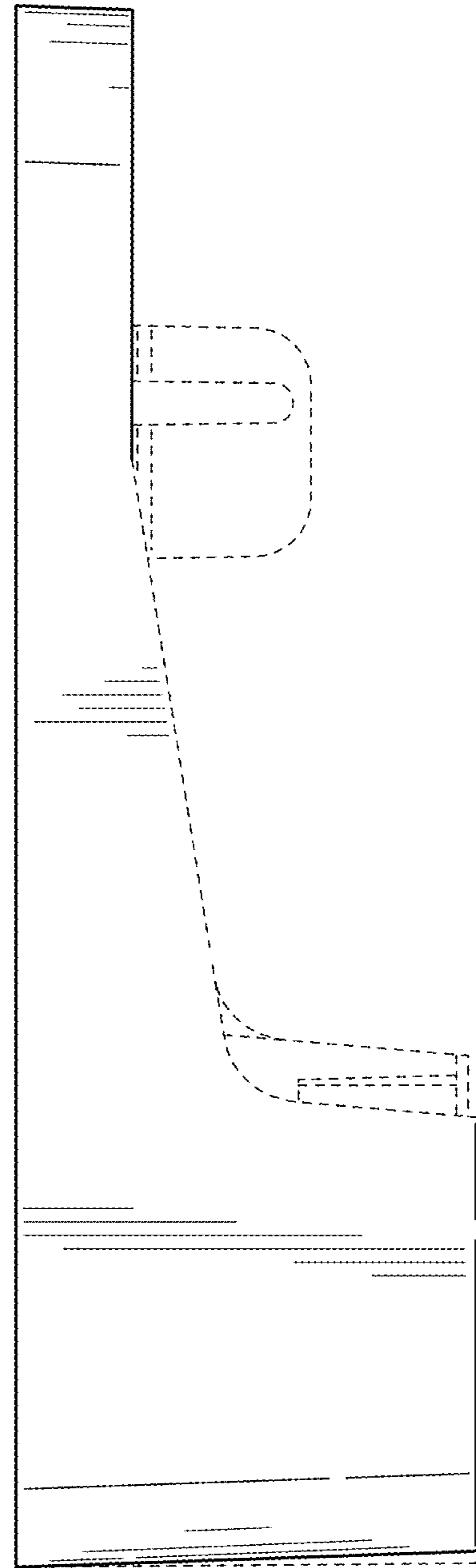

FIG. 40

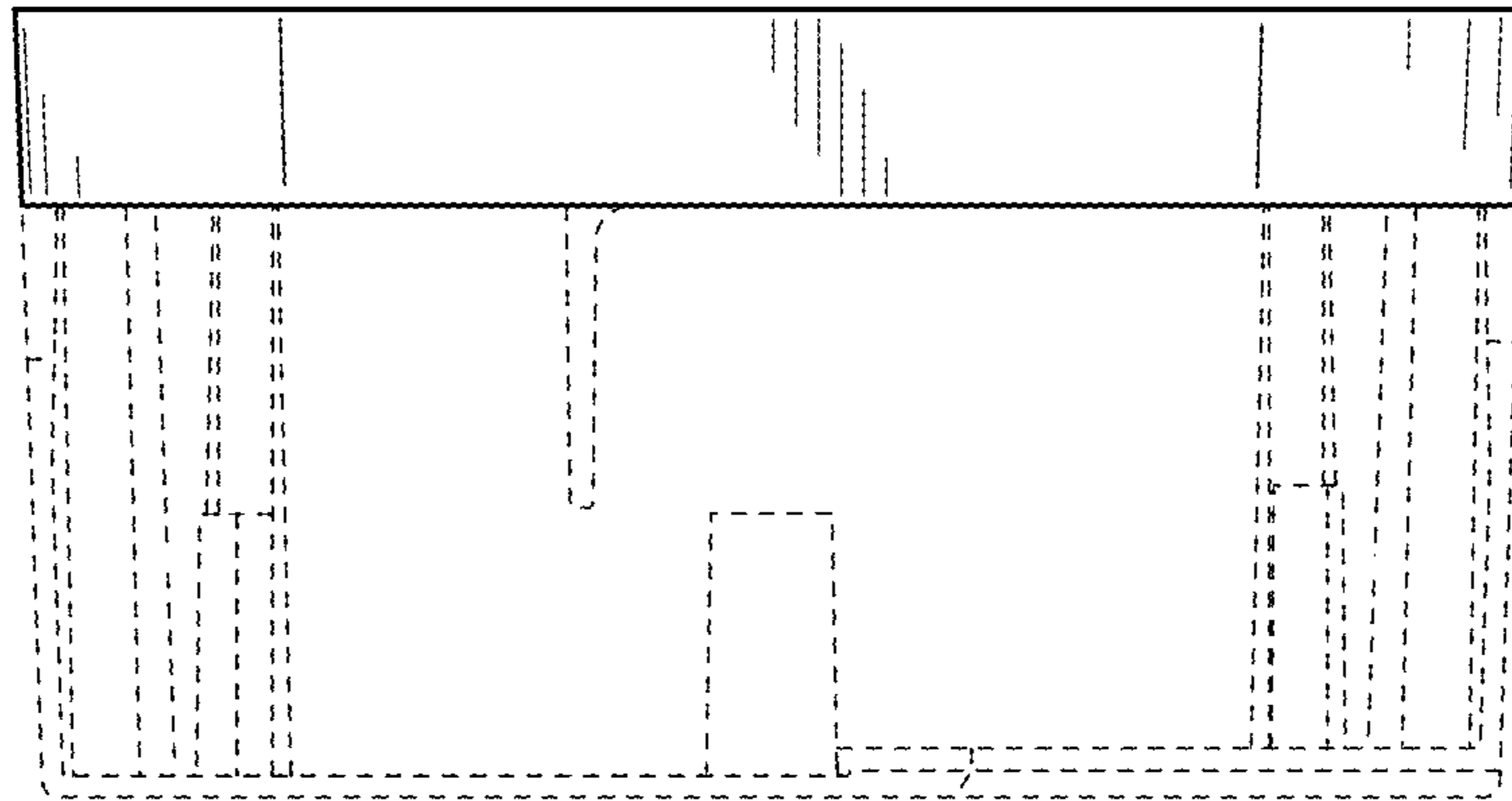

FIG. 41

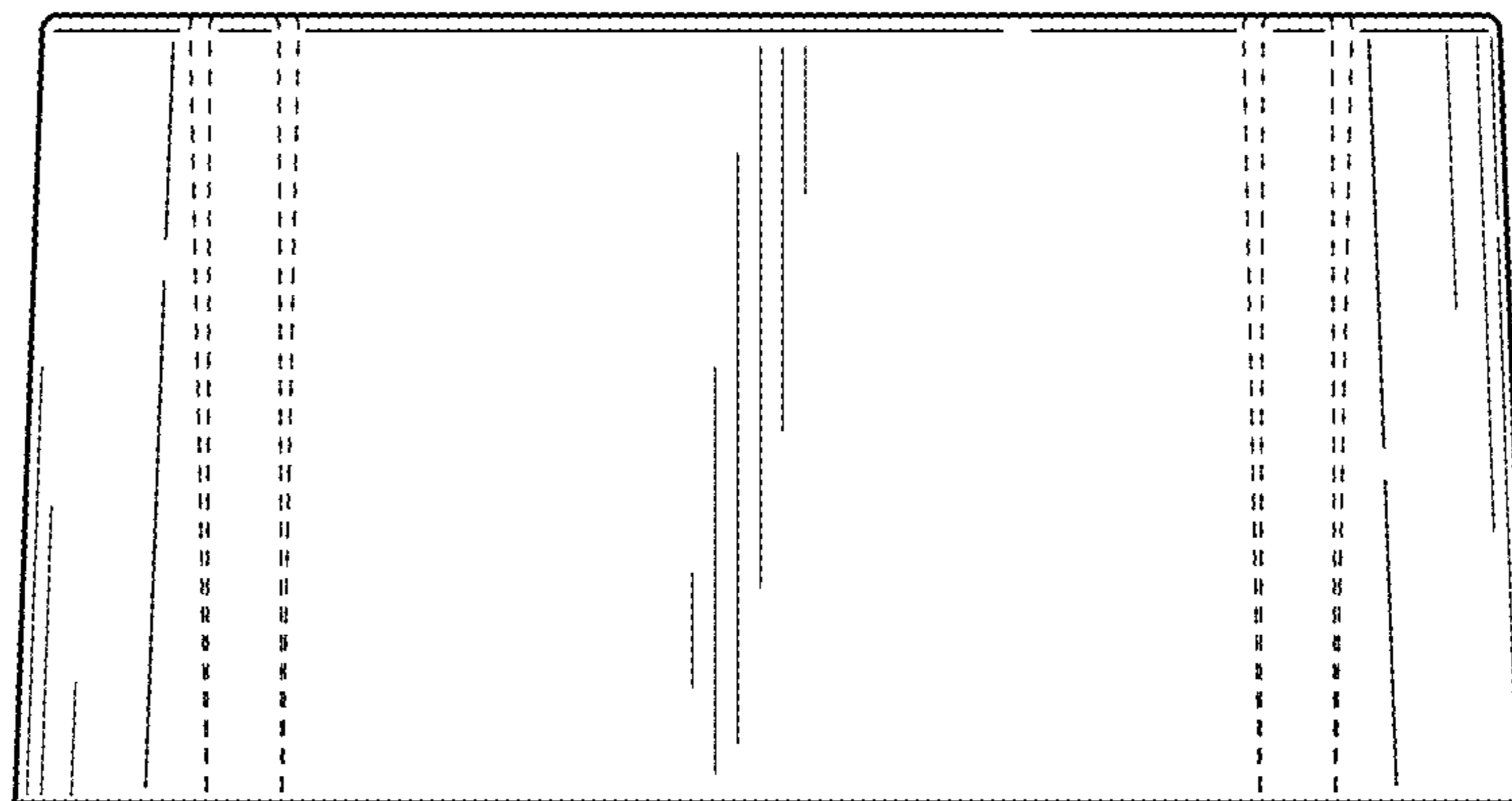

FIG. 42



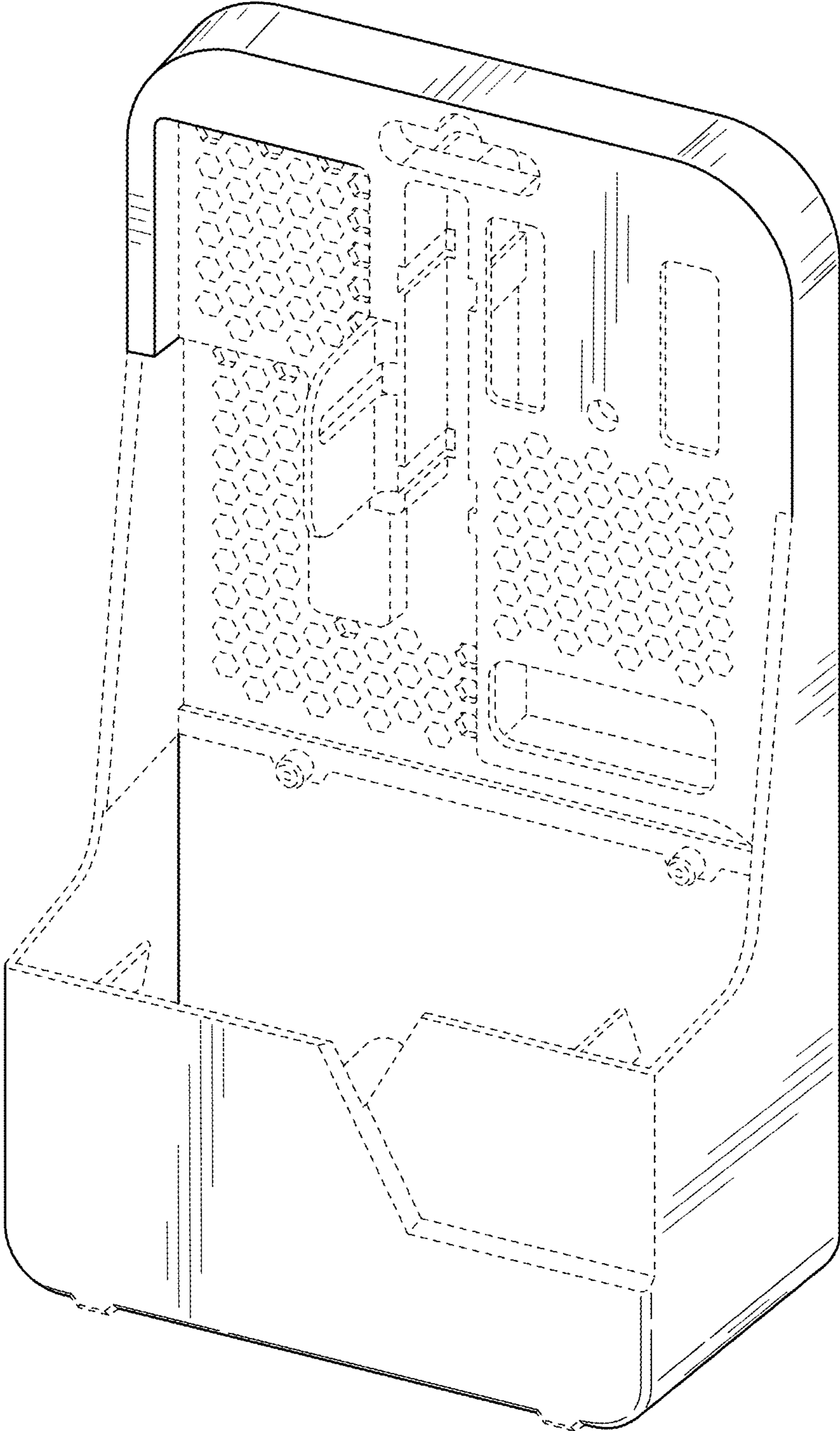

FIG. 43

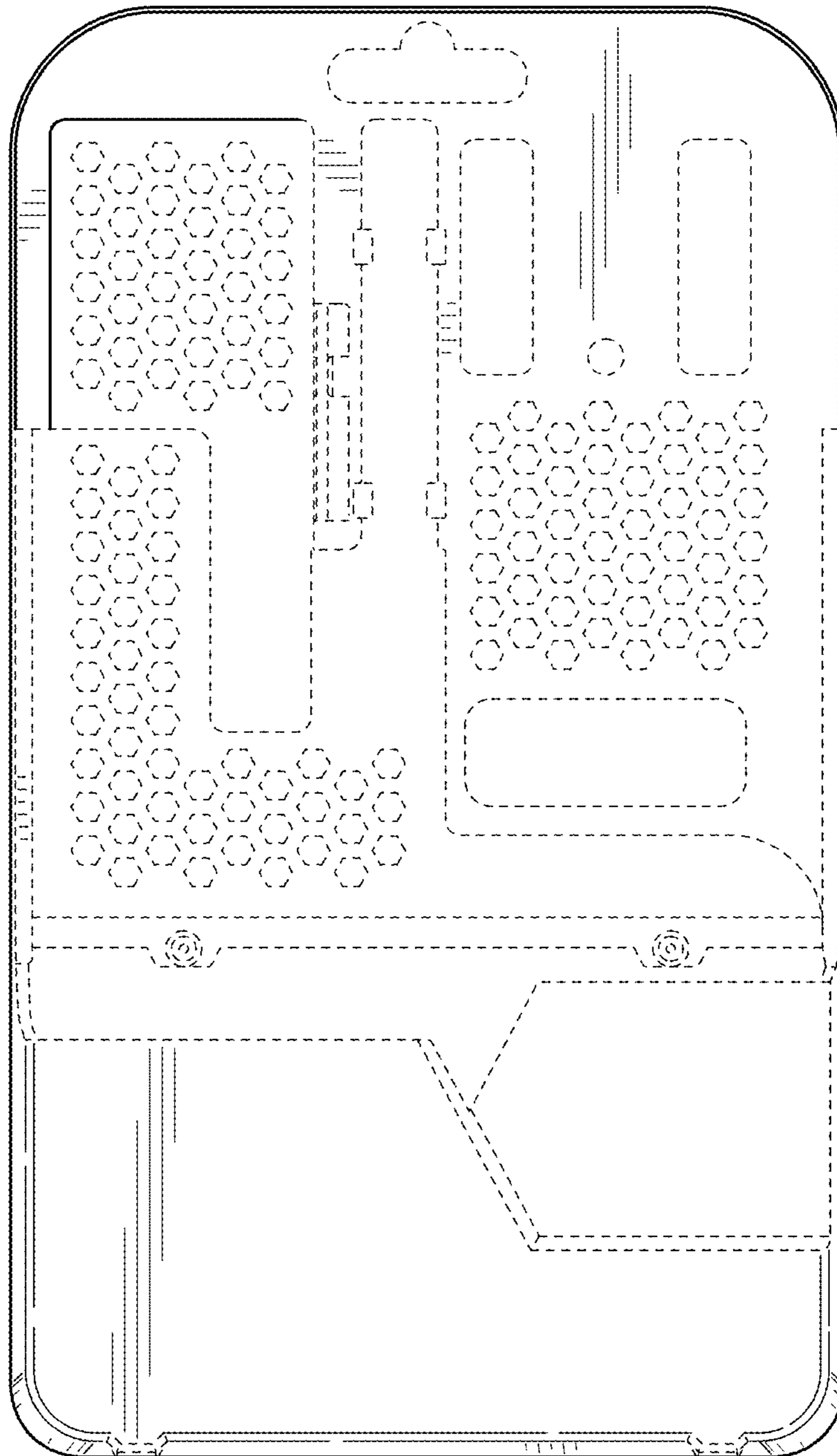

FIG. 44

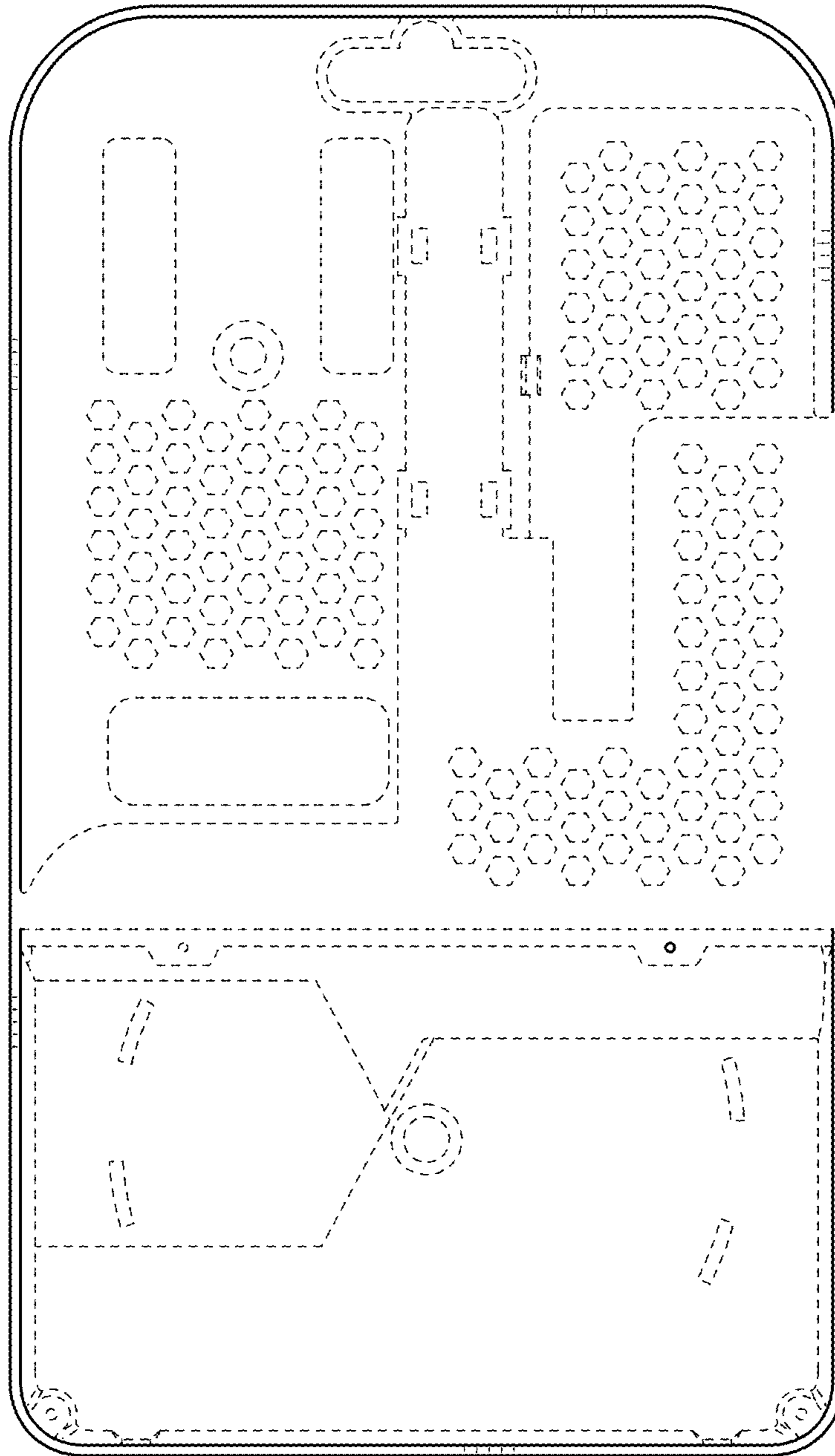

FIG. 45

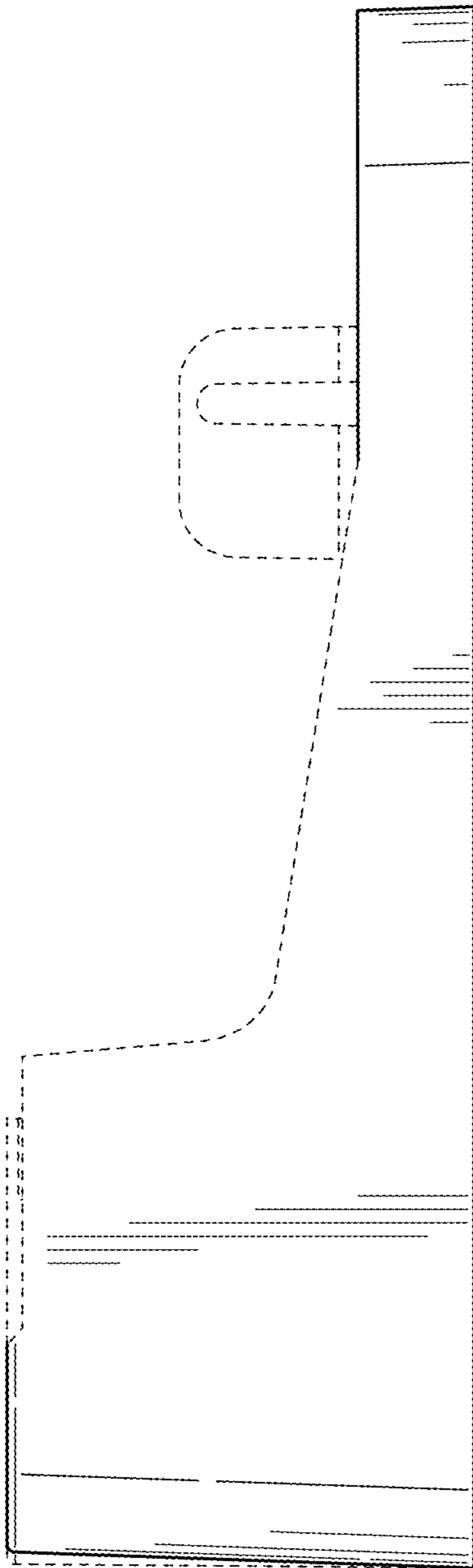

FIG. 46

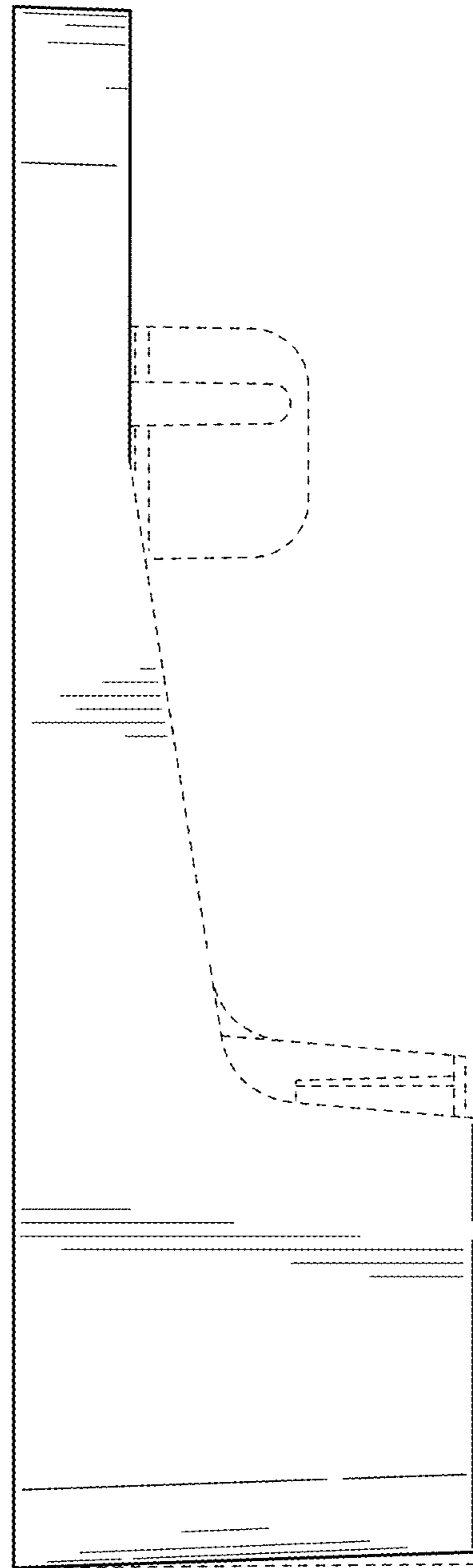

FIG. 47

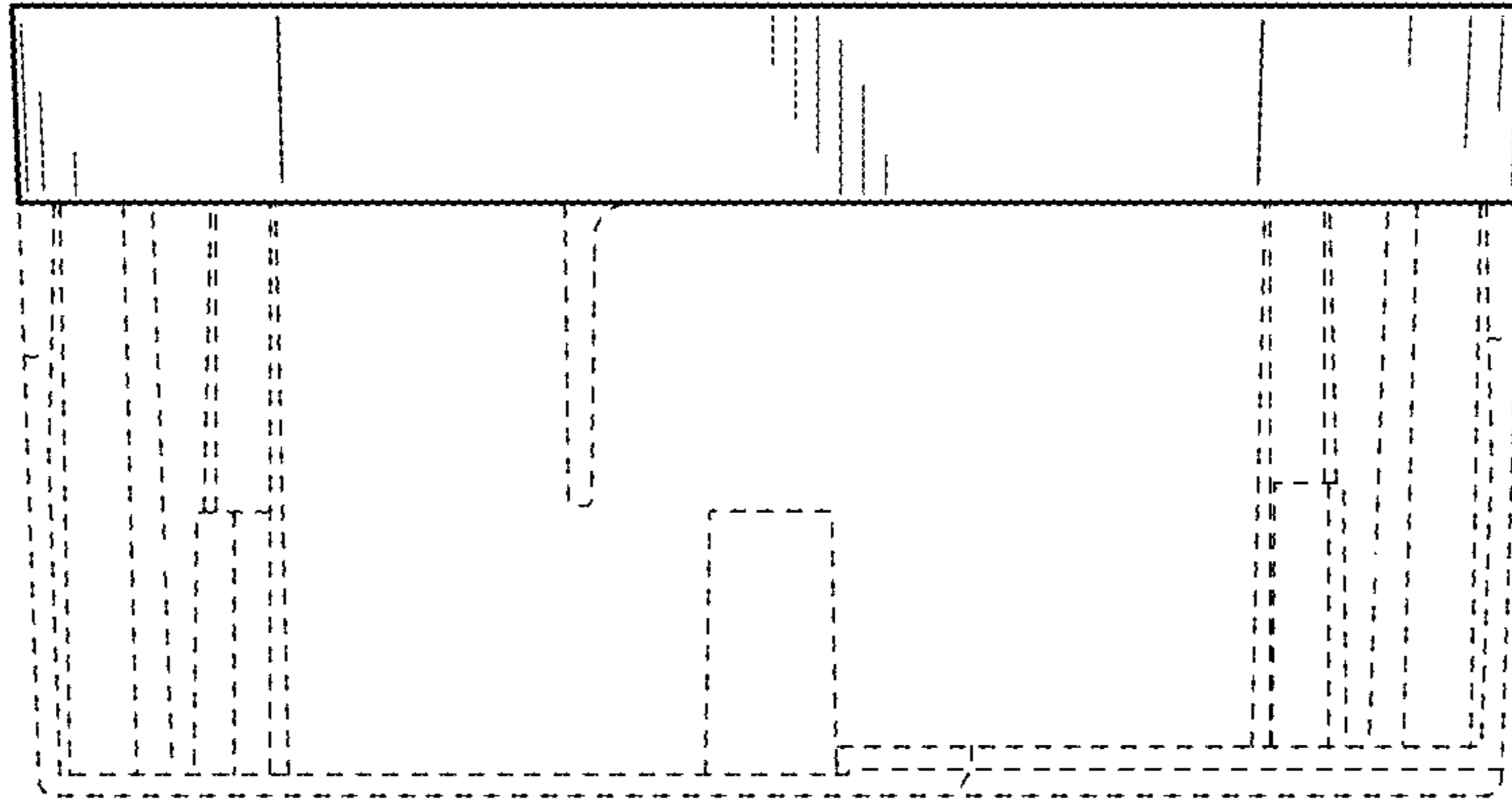

FIG. 48

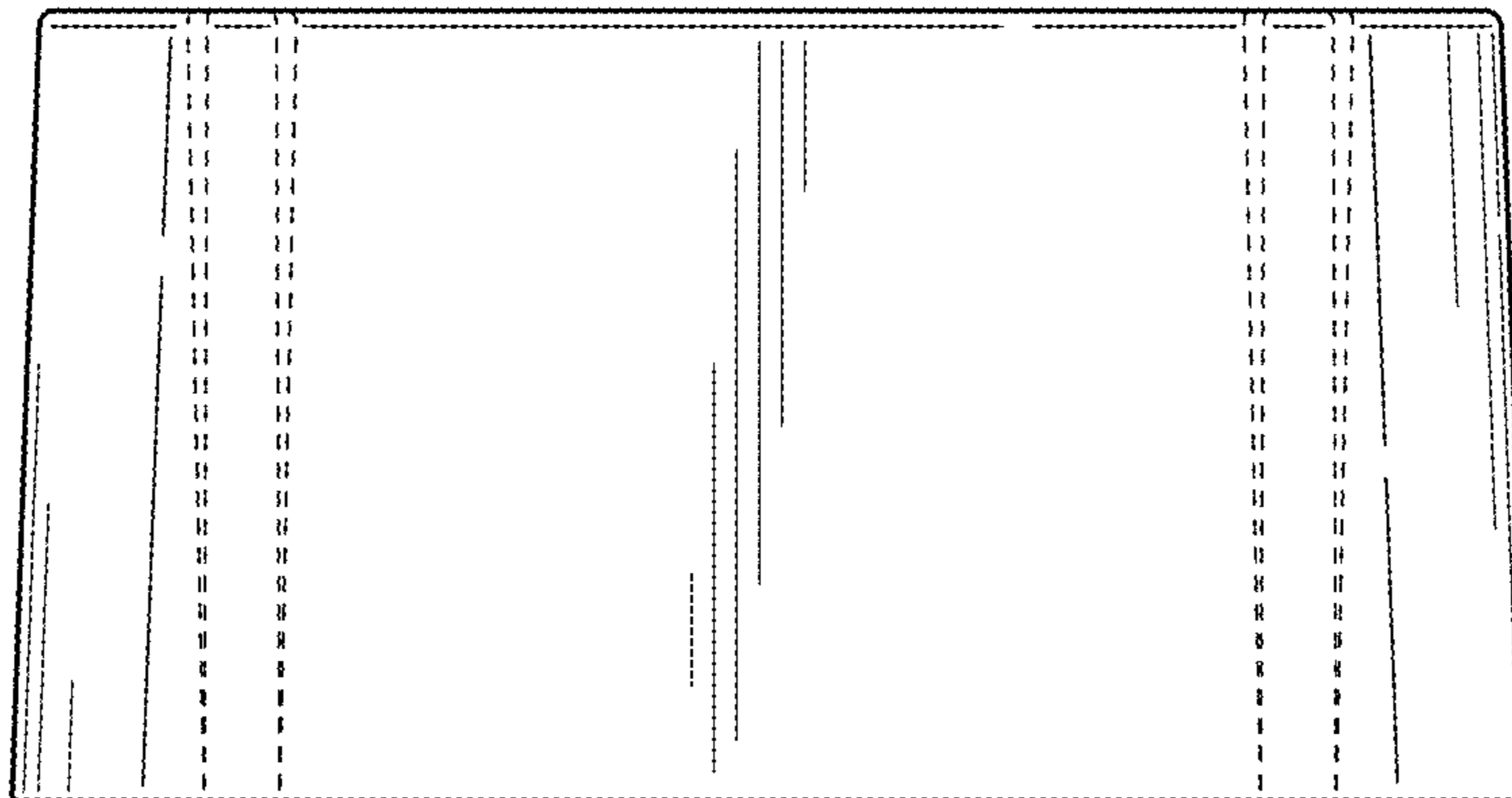

FIG. 49

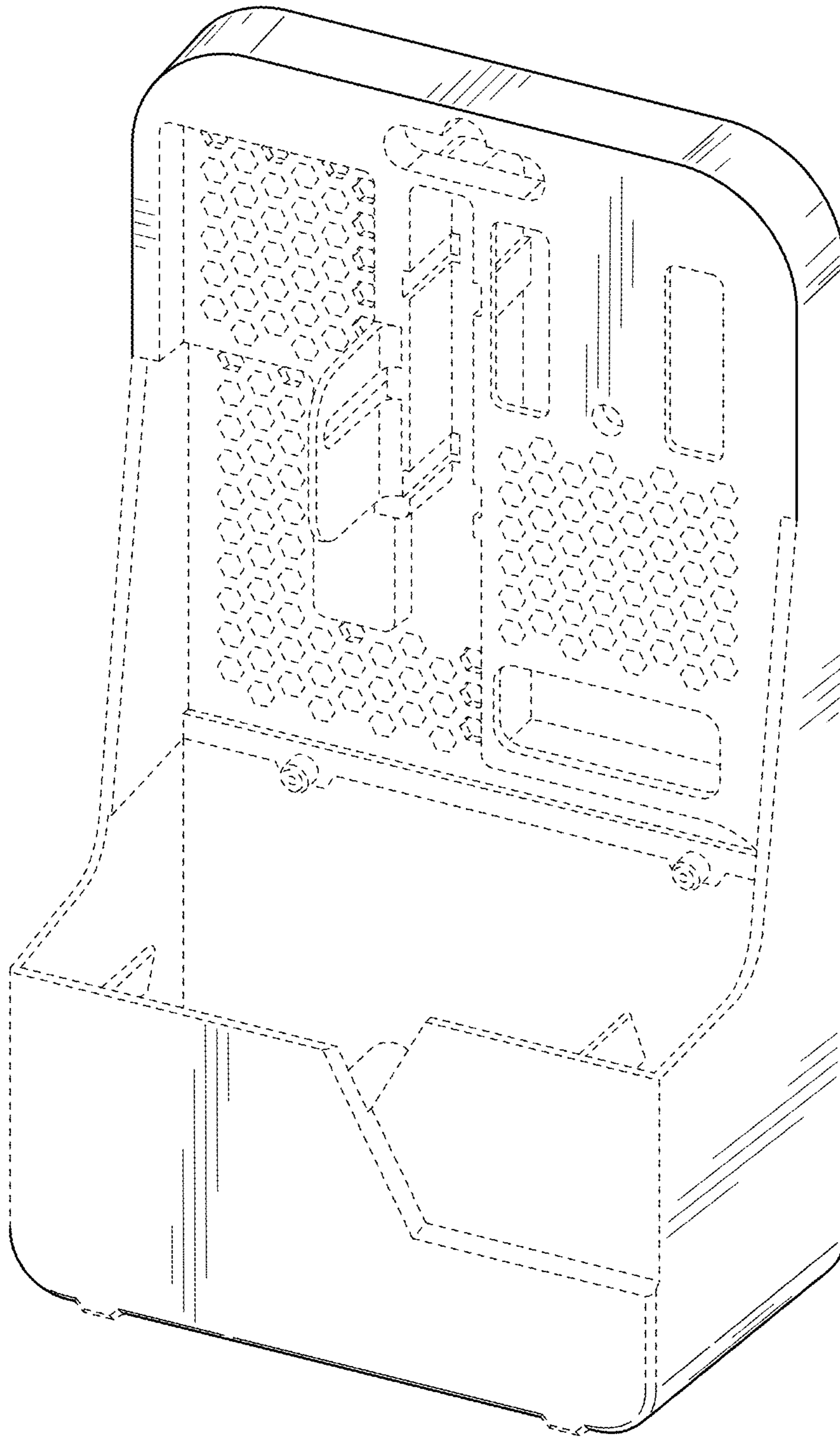

FIG. 50

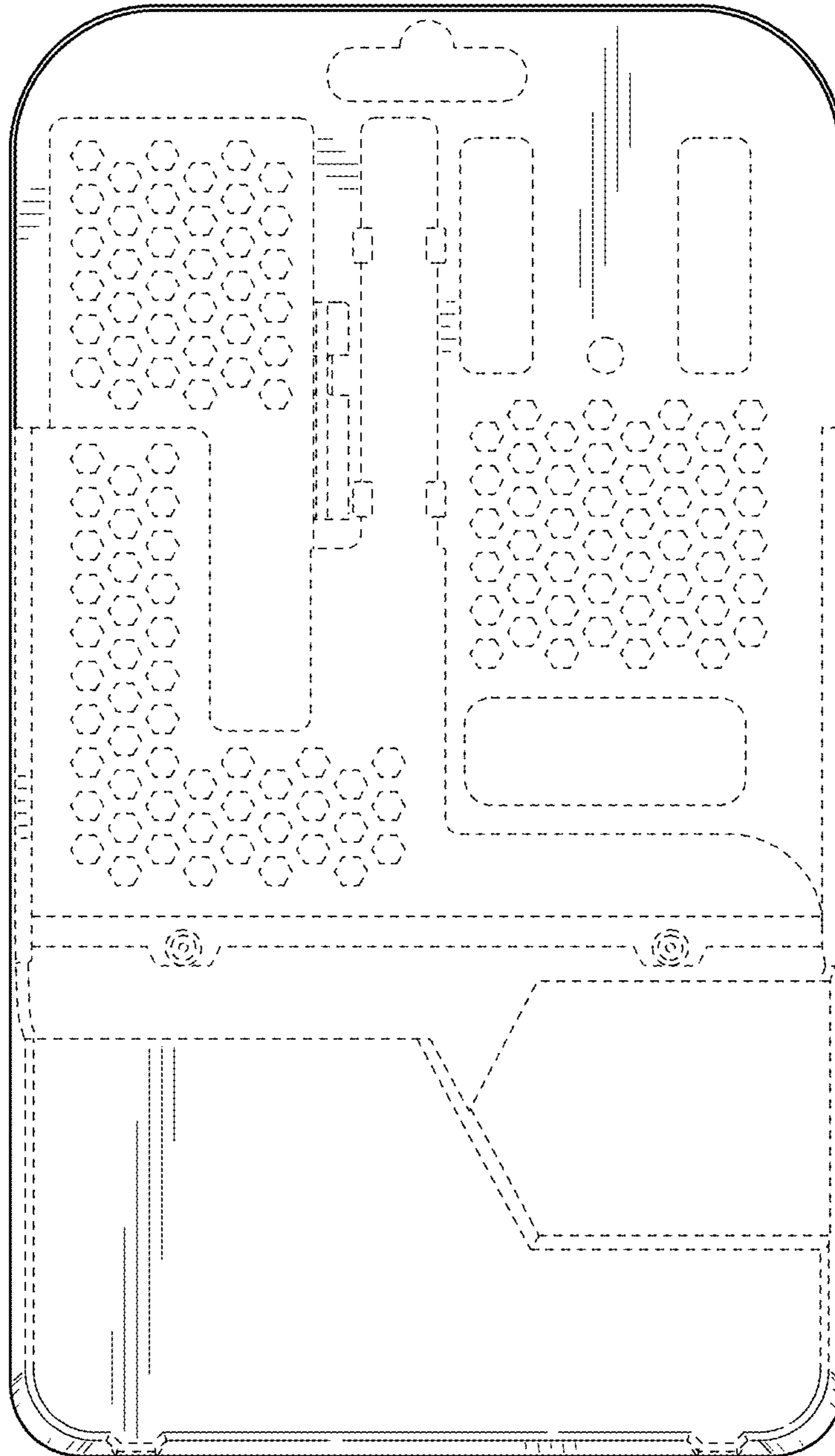

FIG. 51

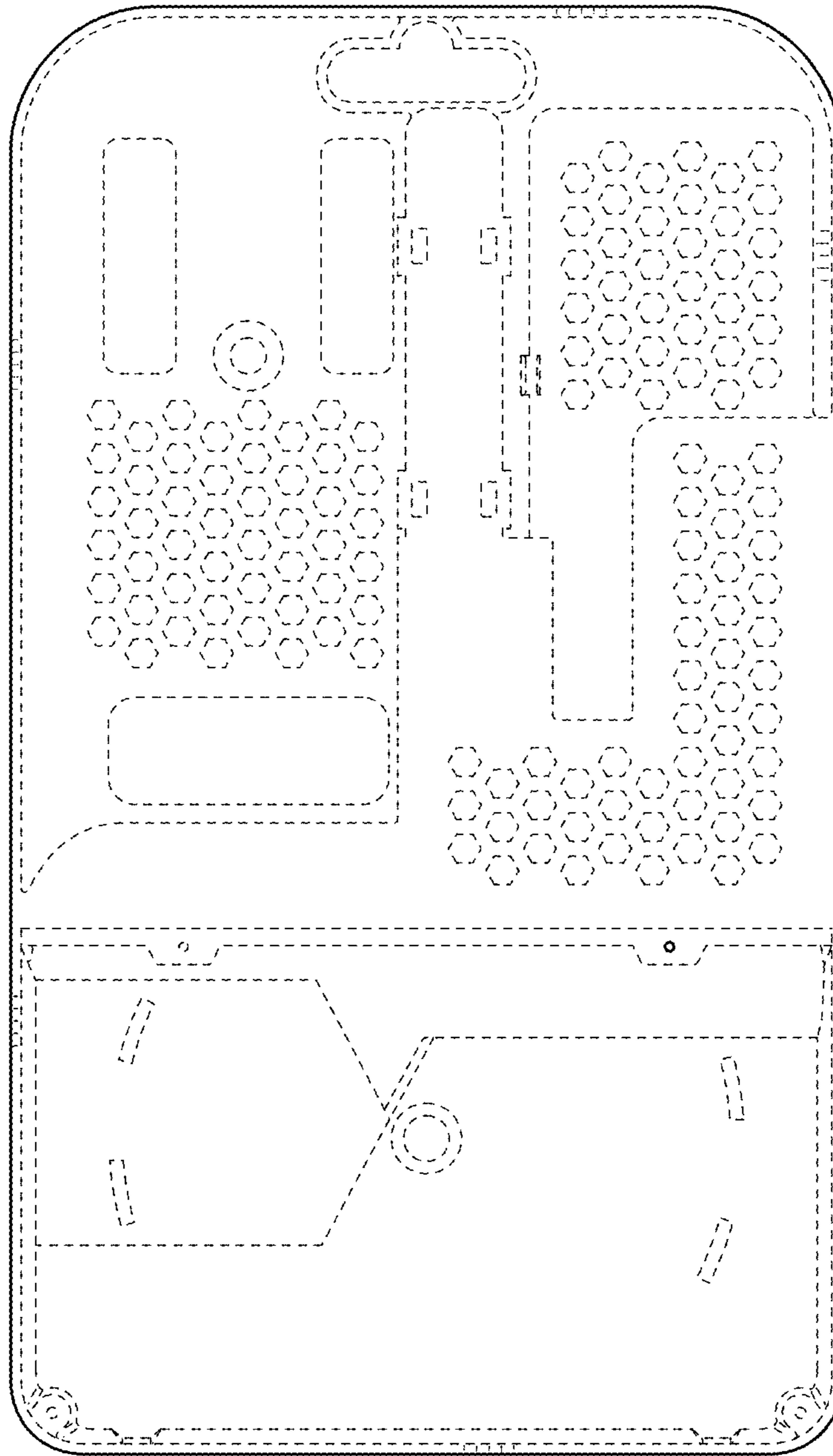

FIG. 52



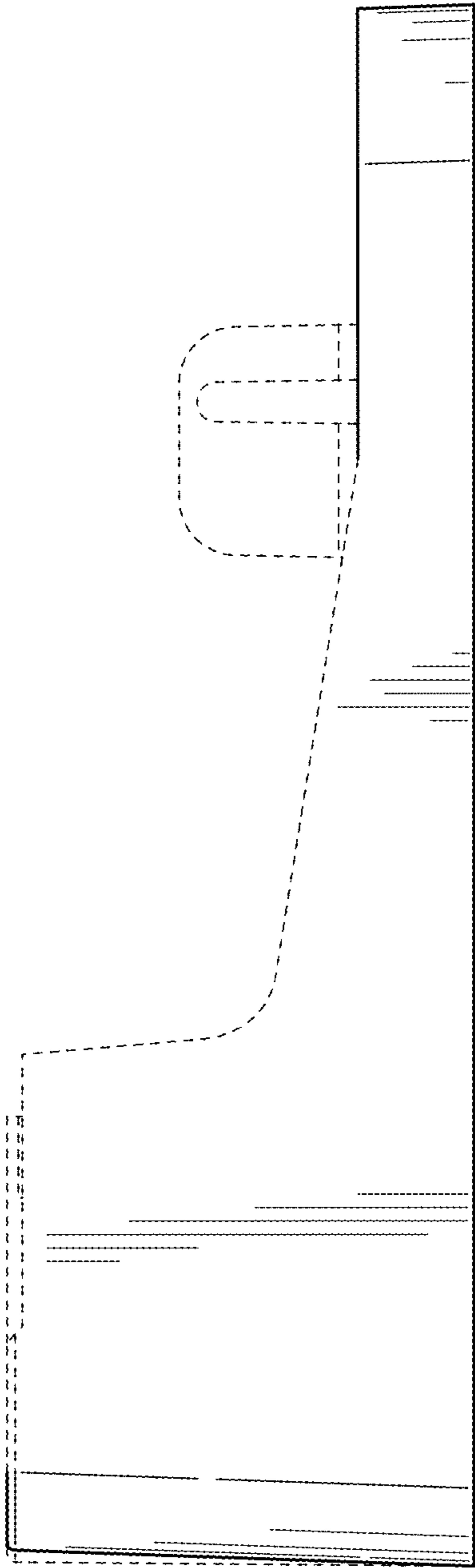

FIG. 53

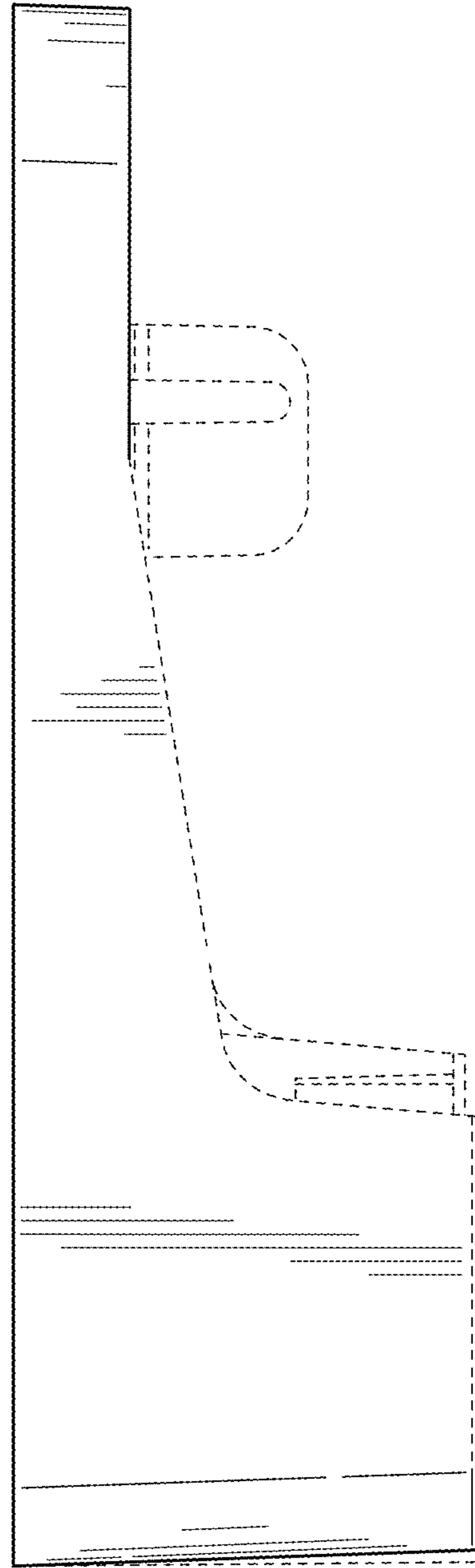

FIG. 54

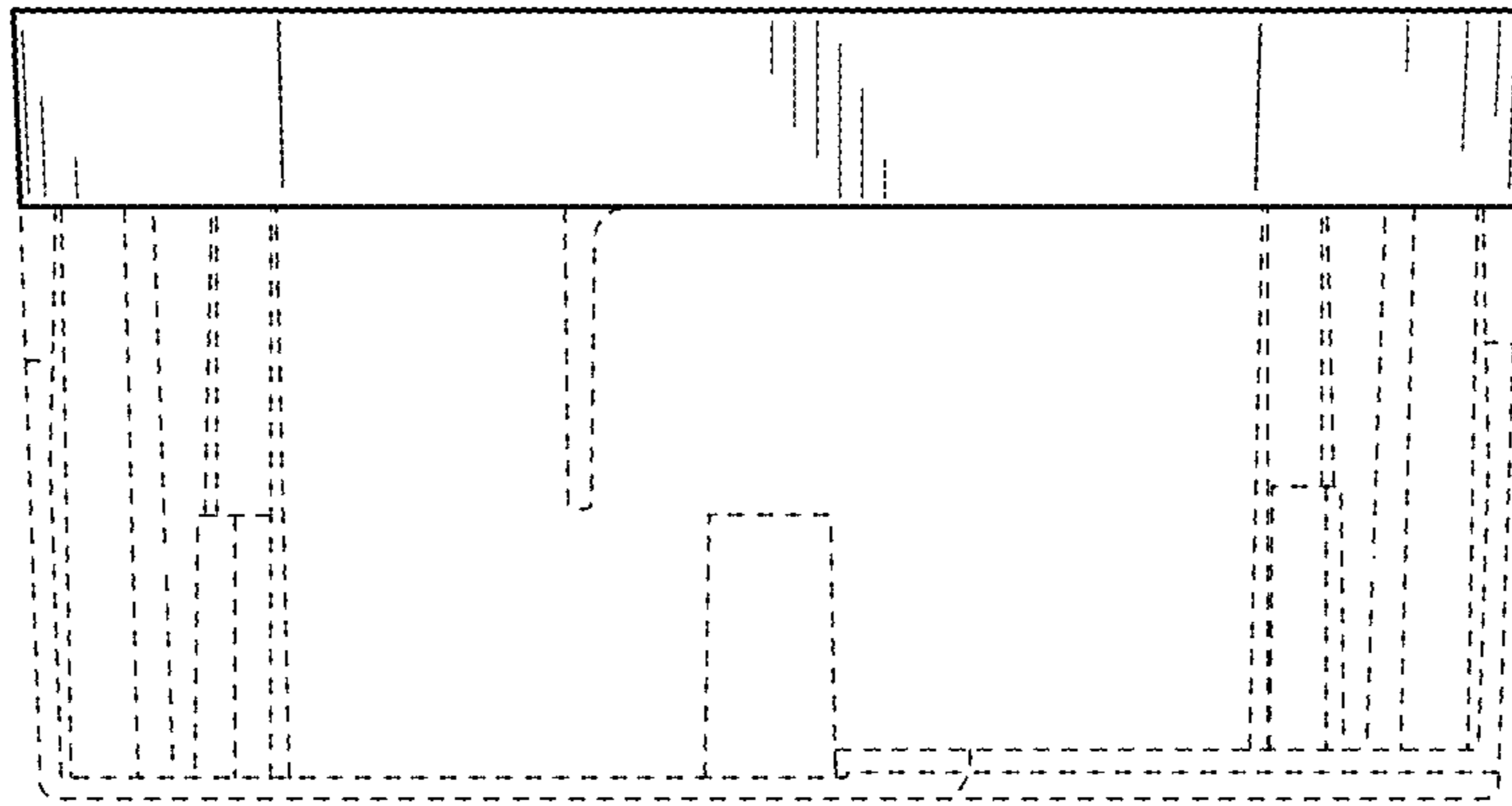

FIG. 55

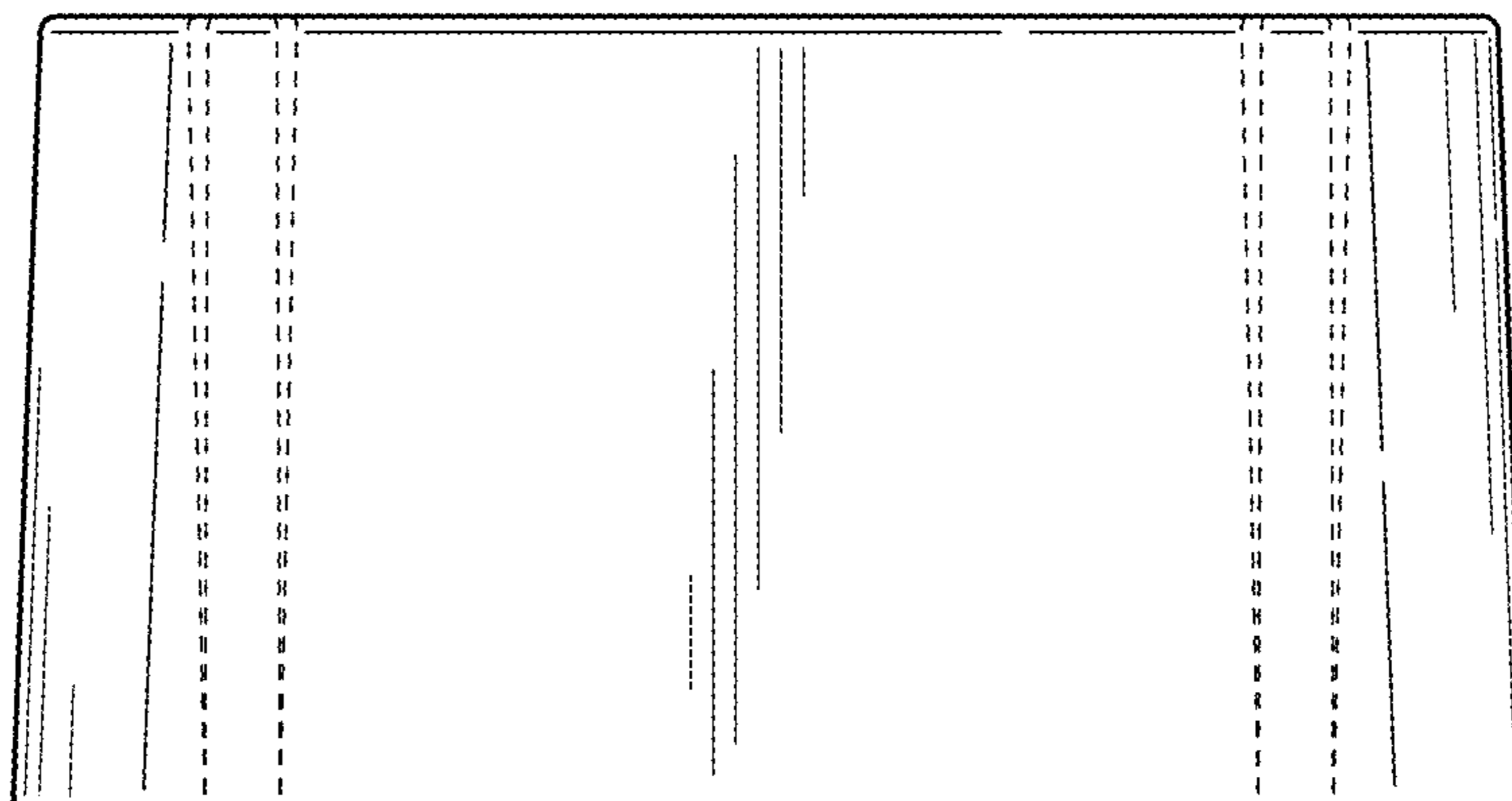

FIG. 56

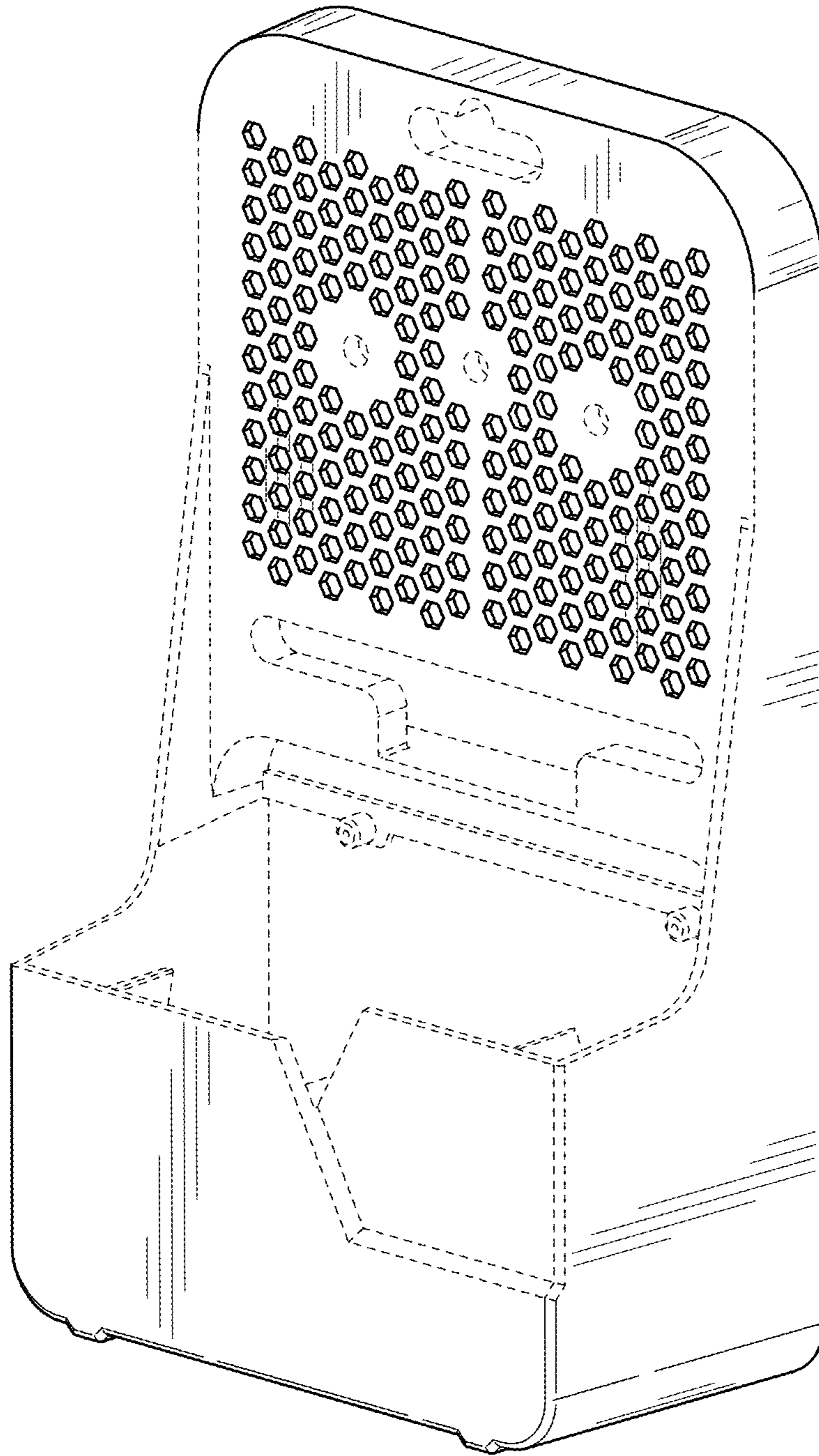

FIG. 57

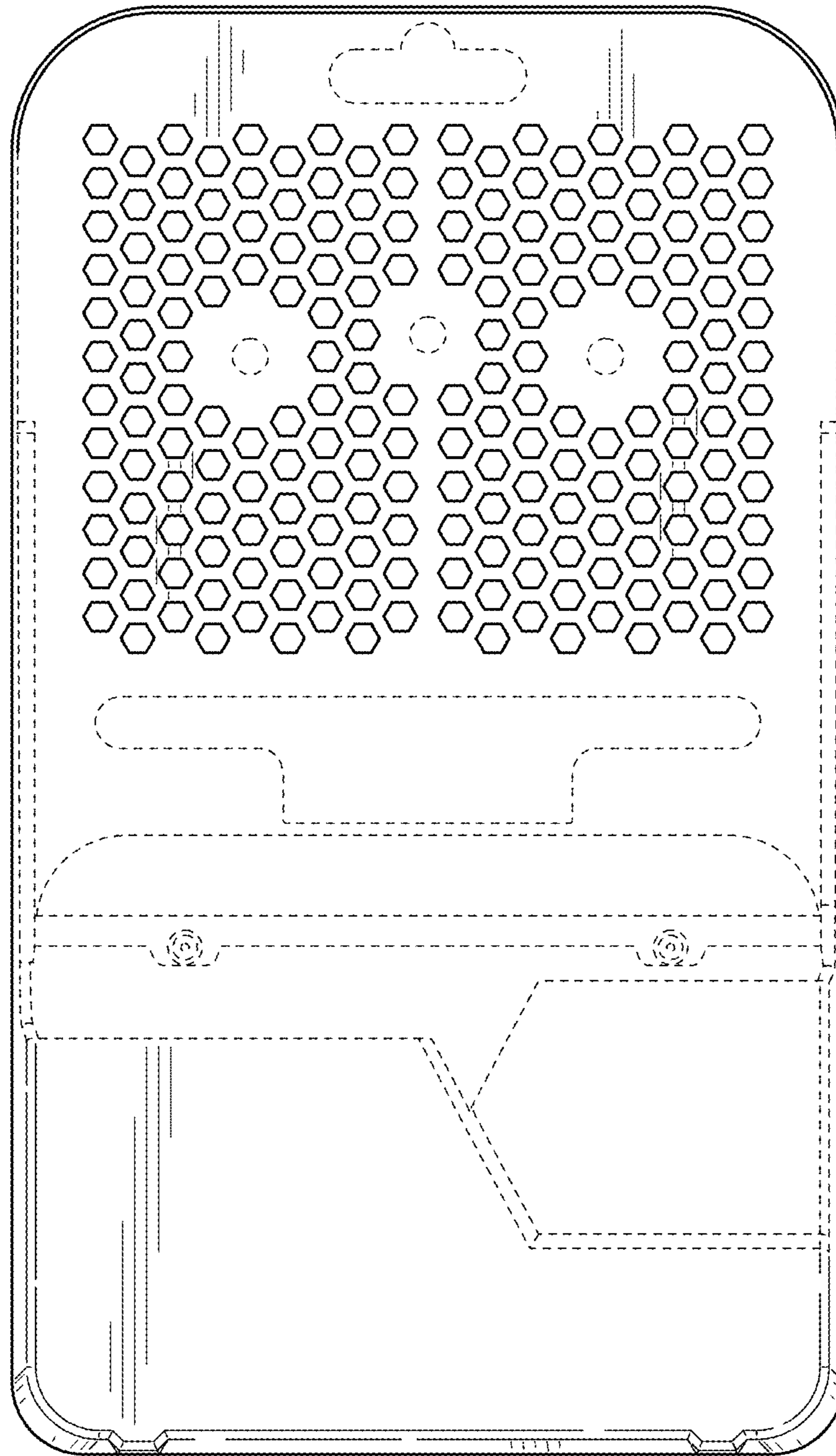

FIG. 58

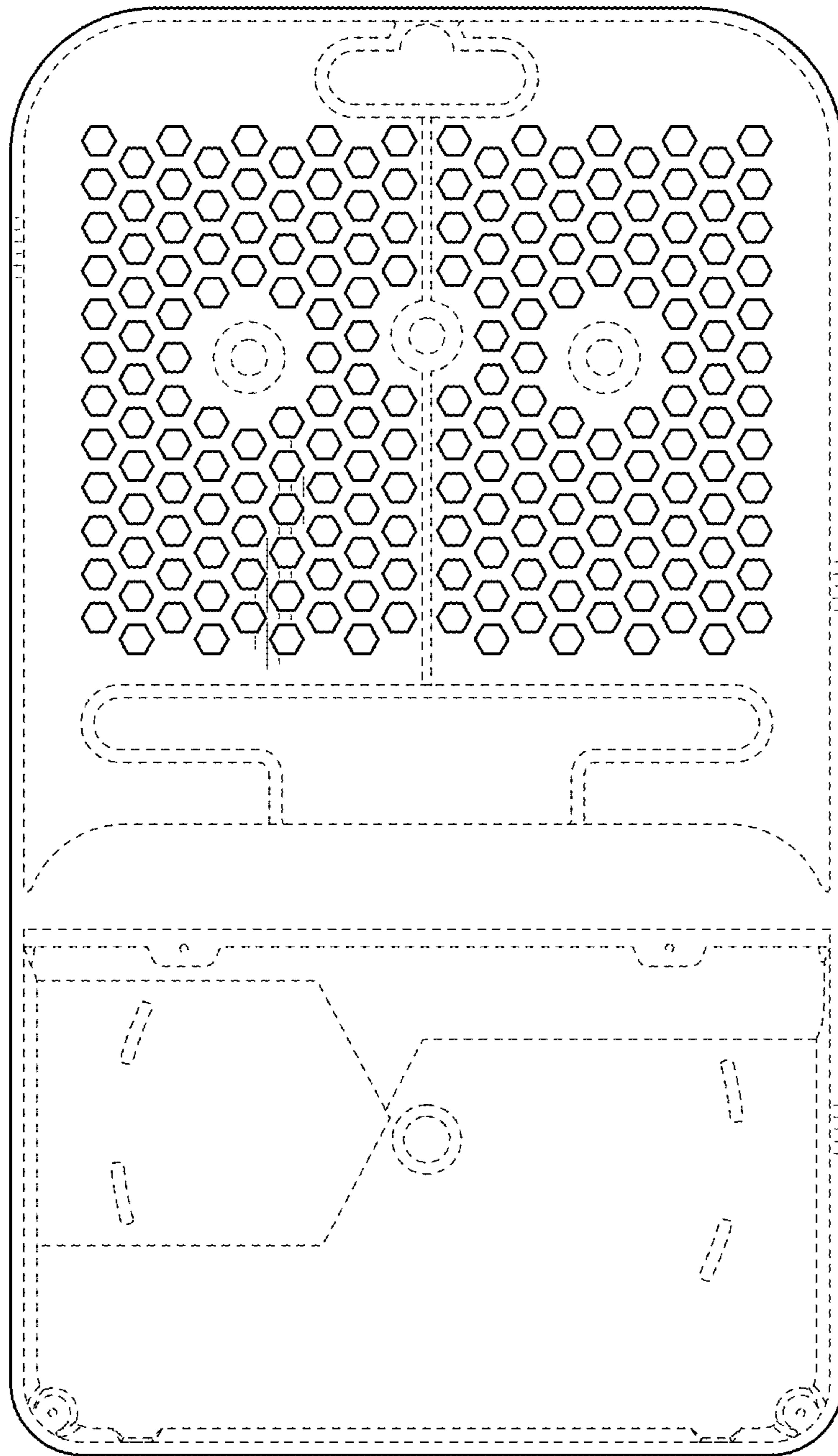

FIG. 59

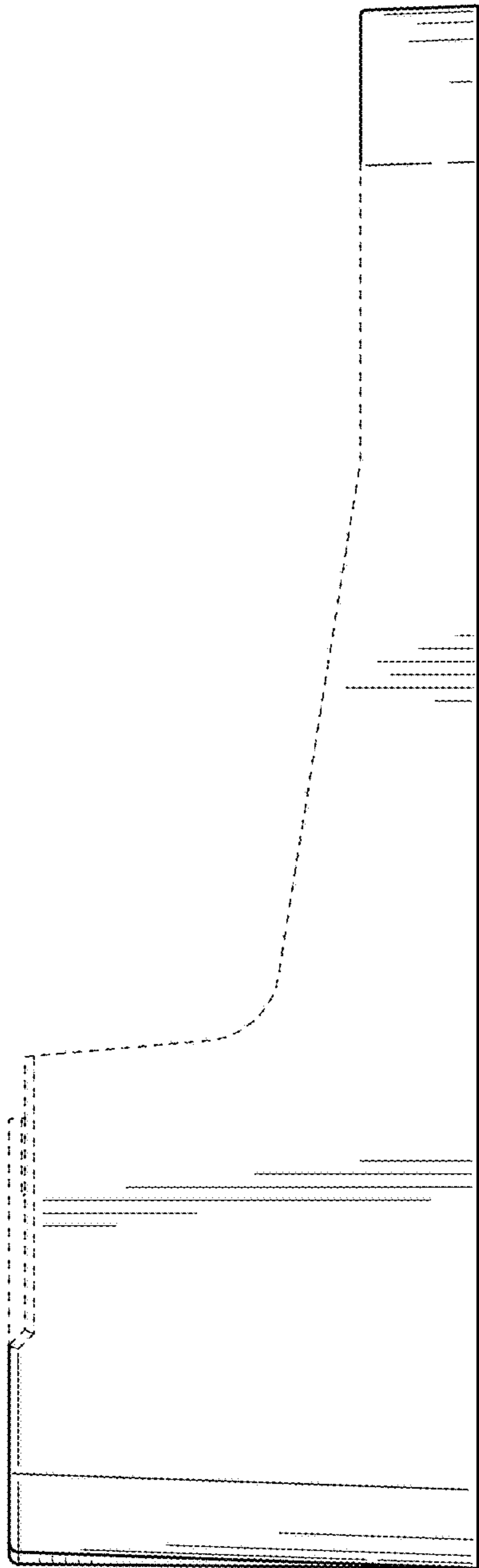

FIG. 60

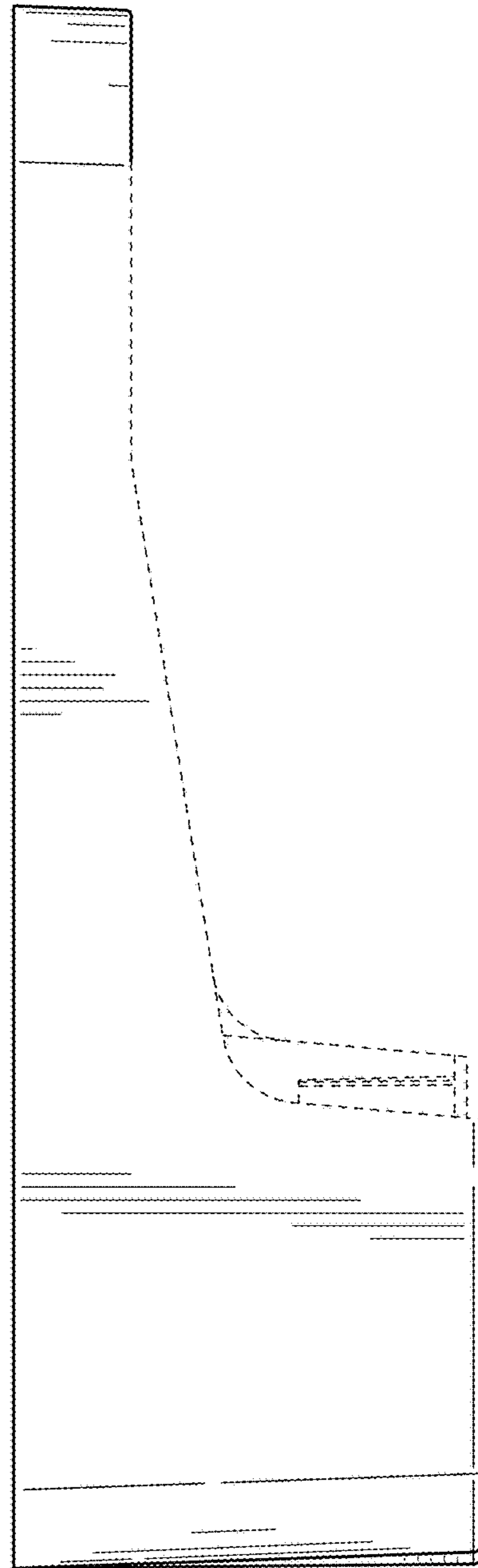

FIG. 61

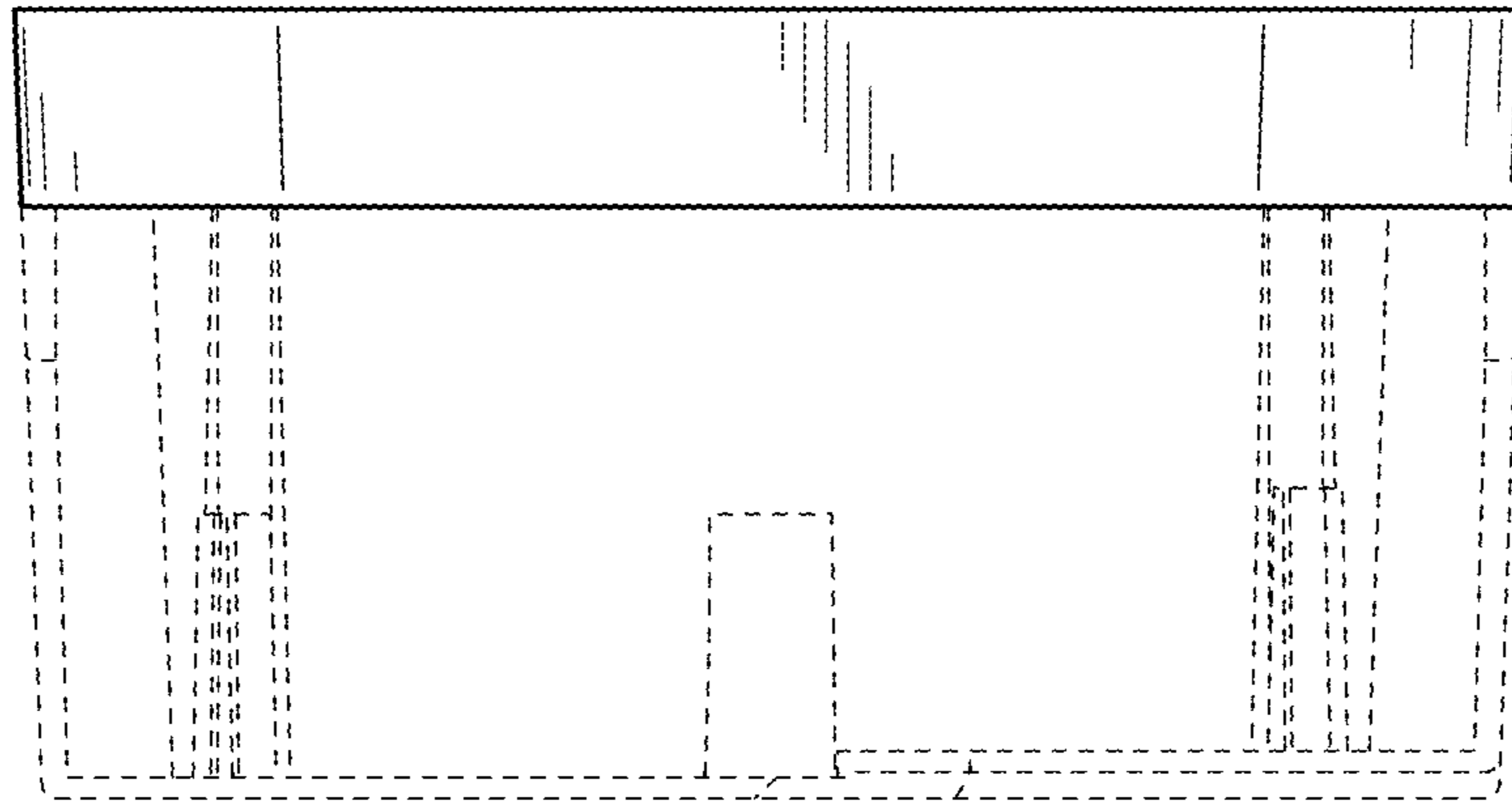

FIG. 62

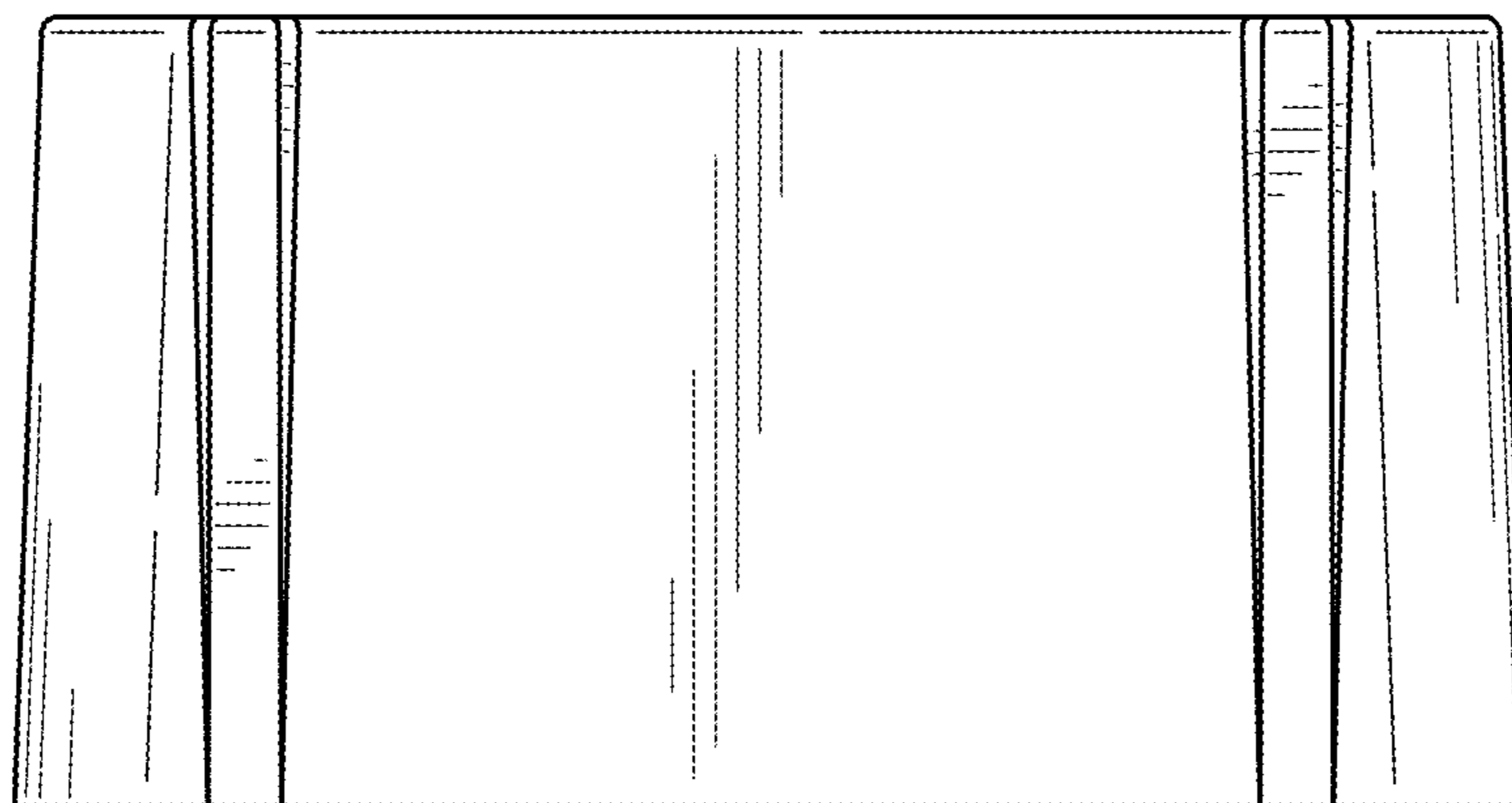

FIG. 63