



US00D803026S

(12) **United States Design Patent**  
**Herskovitz**

(10) **Patent No.:** **US D803,026 S**

(45) **Date of Patent:** **\*\* Nov. 21, 2017**

(54) **PORTABLE, ADJUSTABLE, LIGHTWEIGHT CABINET LOCK**

(71) Applicant: **Paul Herskovitz**, Baltimore, MD (US)

(72) Inventor: **Paul Herskovitz**, Baltimore, MD (US)

(\*\*) Term: **15 Years**

(21) Appl. No.: **29/571,210**

(22) Filed: **Jul. 15, 2016**

(51) **LOC (10) Cl.** ..... **08-07**

(52) **U.S. Cl.**  
USPC ..... **D8/331**

(58) **Field of Classification Search**  
USPC ..... D8/330, 331, 339-342, 349, 367, 400;  
70/14, 19, 57, 57.1, 58, 51, 52, 199, 237,  
70/240, 431, 288, 94, 99, 175, 177, 209,  
70/225, 226, 70-84; 292/92, 339, 259 R,  
292/259 A, 57, 262, 273, 305, 306,  
292/DIG. 47, 292-296; 49/57, 61, 62,  
49/303, 463-466  
CPC ..... E05B 73/00  
See application file for complete search history.

(56) **References Cited**

**U.S. PATENT DOCUMENTS**

D244,174 S \* 5/1977 Sankey ..... 292/292  
6,969,129 B2 \* 11/2005 Ludwig ..... E05B 65/464  
312/217  
7,784,313 B2 \* 8/2010 Wyers ..... E05B 67/003  
70/14

8,157,839 B2 \* 4/2012 Riskin ..... A61B 17/083  
606/214  
8,167,386 B2 \* 5/2012 Bergesch ..... E05B 65/02  
292/32  
8,402,798 B2 \* 3/2013 Brojanac ..... E05B 67/383  
137/385  
D766,068 S \* 9/2016 Marsden ..... D8/331  
D769,101 S \* 10/2016 Zemel ..... D8/321  
D770,263 S \* 11/2016 Marsden ..... D8/330  
D779,263 S \* 2/2017 Suh ..... D7/351  
D785,440 S \* 5/2017 Marsden ..... D8/331

\* cited by examiner

*Primary Examiner* — Prabhakar G Deshmukh

(74) *Attorney, Agent, or Firm* — ATLawip LLC; Jeffrey T Breloski

(57) **CLAIM**

The ornamental design for a portable, adjustable, light-weight cabinet lock, as shown and described.

**DESCRIPTION**

FIG. 1 is a top front perspective view of a portable, adjustable, lightweight cabinet lock showing my new design; FIG. 2 is a top plan view thereof; FIG. 3 is a front elevational view thereof; FIG. 4 is a left side elevational view thereof; FIG. 5 is a right side elevational view thereof; FIG. 6 is a top front perspective view of a second embodiment of a portable, adjustable, lightweight cabinet lock; and, FIG. 7 is a top plan view of FIG. 6.

**1 Claim, 3 Drawing Sheets**

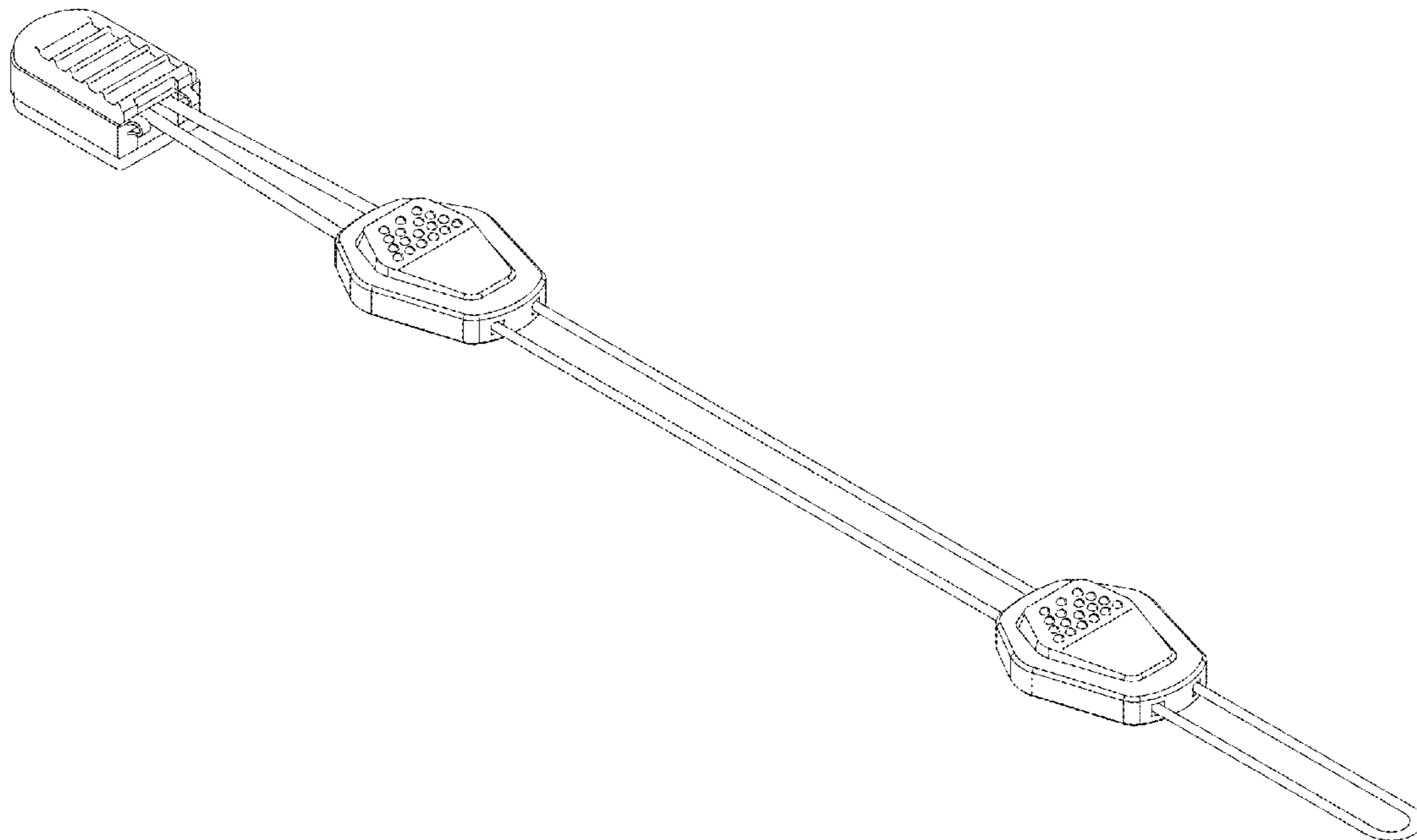

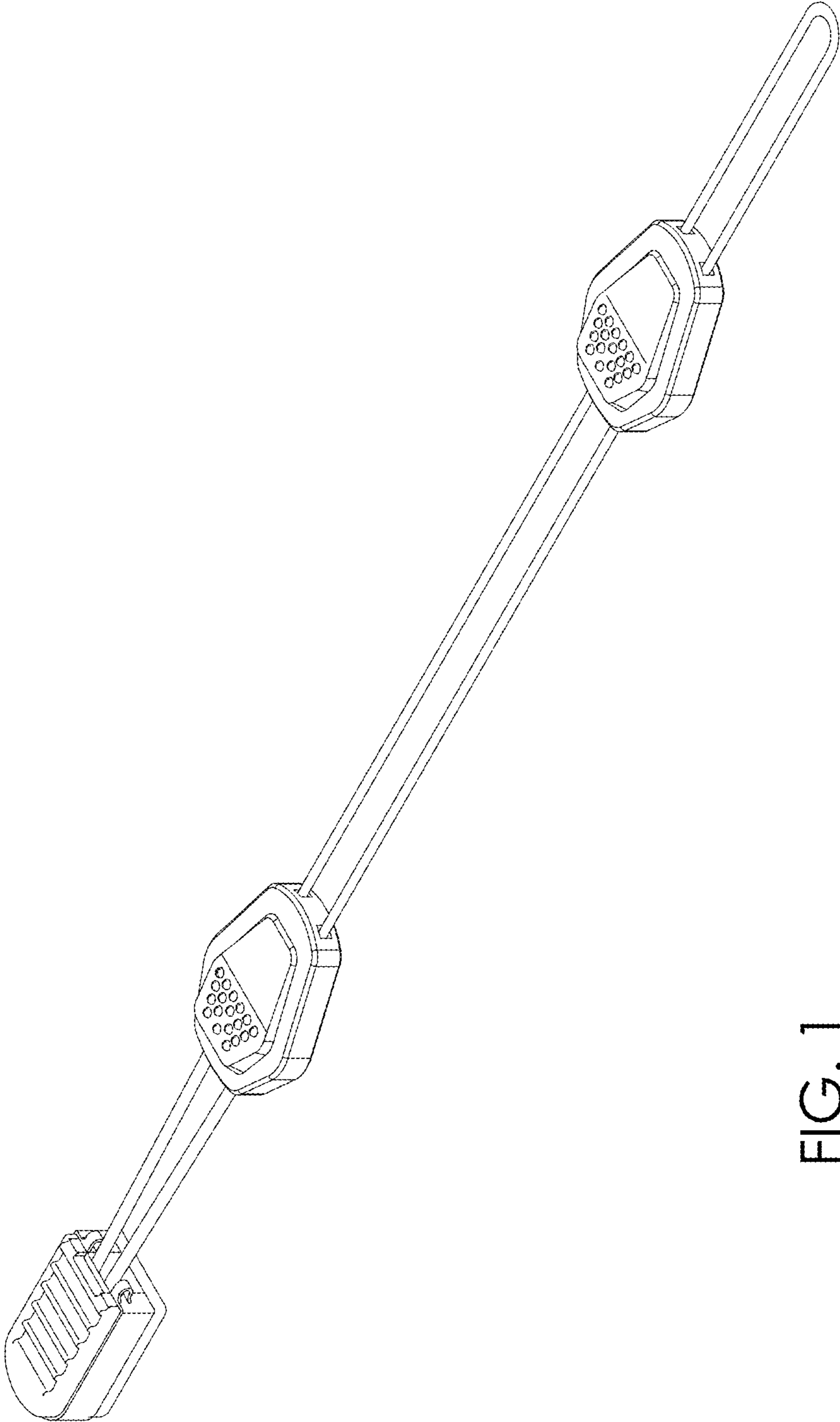

FIG. 1

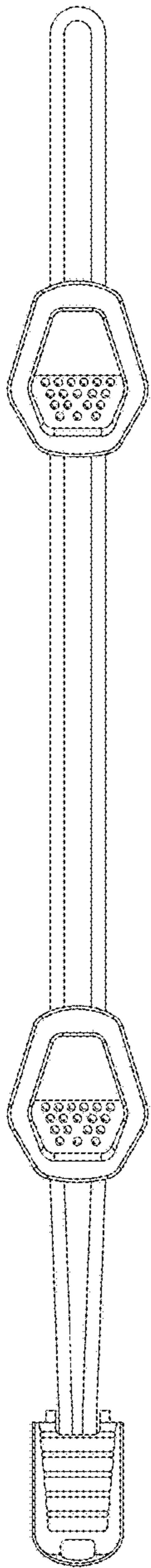

FIG. 2

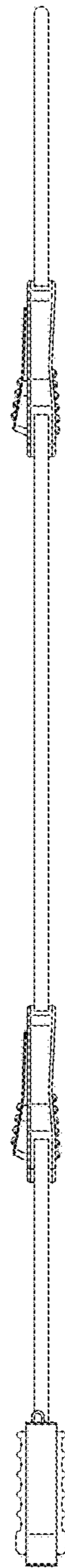

FIG. 3



FIG. 4

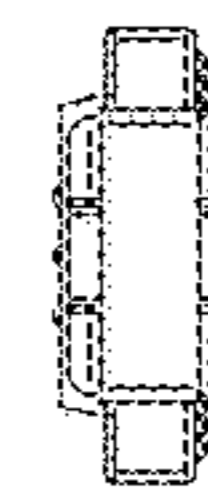

FIG. 5

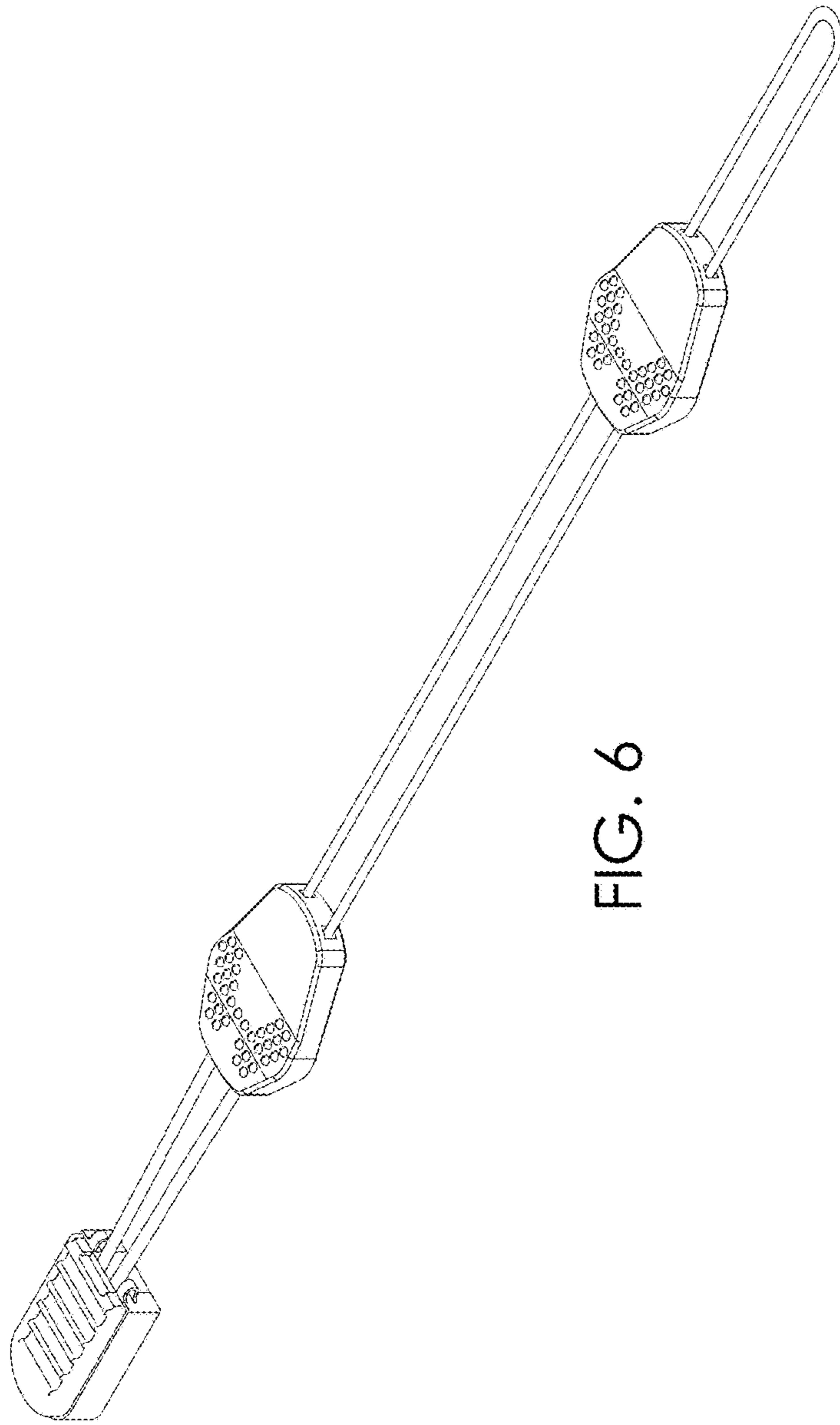

FIG. 6

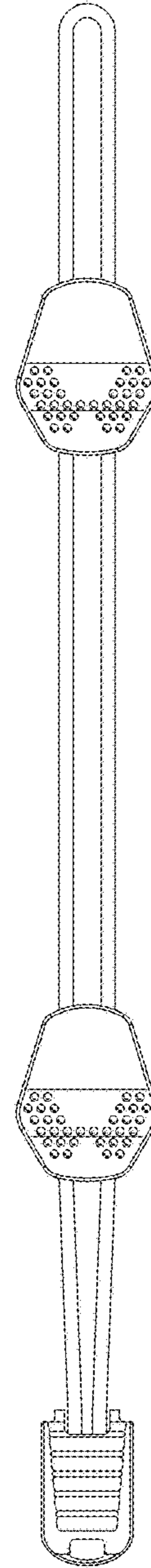

FIG. 7