



US00D802992S

(12) **United States Design Patent** (10) **Patent No.:** **US D802,992 S**
Wilson et al. (45) **Date of Patent:** **** Nov. 21, 2017**

(54) **BLEND MACHINE**

(71) Applicant: **Altopa, Inc.**, Vashon, WA (US)

(72) Inventors: **Matt Wilson**, Vashon, WA (US); **Nicole Kaylor Wicker**, Raleigh, NC (US); **Todd Wilson**, Delray Beach, FL (US); **Scott Eric Liddle**, Raleigh, NC (US); **Pete Crawford**, Bend, OR (US); **Keith Gausmann**, Cary, NC (US); **Jaysun Giesler**, Cary, NC (US)

(73) Assignee: **Altopa, Inc.**, Vashon, WA (US)

(**) Term: **15 Years**

(21) Appl. No.: **29/591,063**

(22) Filed: **Jan. 16, 2017**

(51) **LOC (10) Cl.** **31-00**

(52) **U.S. Cl.**
USPC **D7/376; D7/377; D7/378**

(58) **Field of Classification Search**
USPC D7/306-309, 372, 376-386, 399, D7/412-413, 602, 629, 665-666, 669, D7/679, 693-694; D15/89; D20/1
CPC A21C 1/02; A21C 1/04; A23N 1/00; A23N 1/02; A47J 43/04; A47J 43/25; A47J 43/27; A47J 43/042; A47J 43/044; A47J 43/046; A47J 43/075; A47J 43/0722; A47J 43/0727; B01F 3/00; B01F 3/0807; B01F 3/0853; B01F 13/0059; B01F 13/0064; B02C 1/08; B02C 2/04; B02C 4/42; B02C 4/142; B02C 4/143; B02C 4/423; B02C 13/1835; B28C 5/10; B28C 5/12; B28C 5/14; B28C 5/16; B67D 3/0029

See application file for complete search history.

(56) **References Cited**

U.S. PATENT DOCUMENTS

4,511,091 A 4/1985 Vasco et al.
D284,538 S 7/1986 Friz

D327,695 S 7/1992 Edstrom
D327,895 S 7/1992 Edstrom
D366,808 S 2/1996 Newnan
D367,797 S * 3/1996 Hauser, II D7/306
D373,046 S 8/1996 Newnan
5,848,735 A * 12/1998 Eddy B67D 3/0029
222/185.1
D408,207 S 4/1999 Bourke
D444,986 S 7/2001 Smith et al.
D450,731 S 11/2001 Papaikonomou et al.
D472,253 S 3/2003 Reedy et al.
D474,111 S 5/2003 Lazaris

(Continued)

FOREIGN PATENT DOCUMENTS

WO 2009032938 A2 3/2009
WO 2017100063 A1 6/2017

(Continued)

Primary Examiner — Ricky Pham

(74) *Attorney, Agent, or Firm* — Cooley LLP; Nathan W. Poulsen

(57) **CLAIM**

The ornamental design for a blend machine, as shown and described.

DESCRIPTION

FIG. 1 is a perspective view of a new design for a blend machine;
FIG. 2 is a front view thereof;
FIG. 3 is a right view thereof, the left view being a mirror image of the right view;
FIG. 4 is a rear view thereof;
FIG. 5 is a top view thereof; and,
FIG. 6 is a bottom view thereof.
The portions depicted in broken lines depict illustrative environmental subject matter only and form no part of the claimed design.

1 Claim, 6 Drawing Sheets

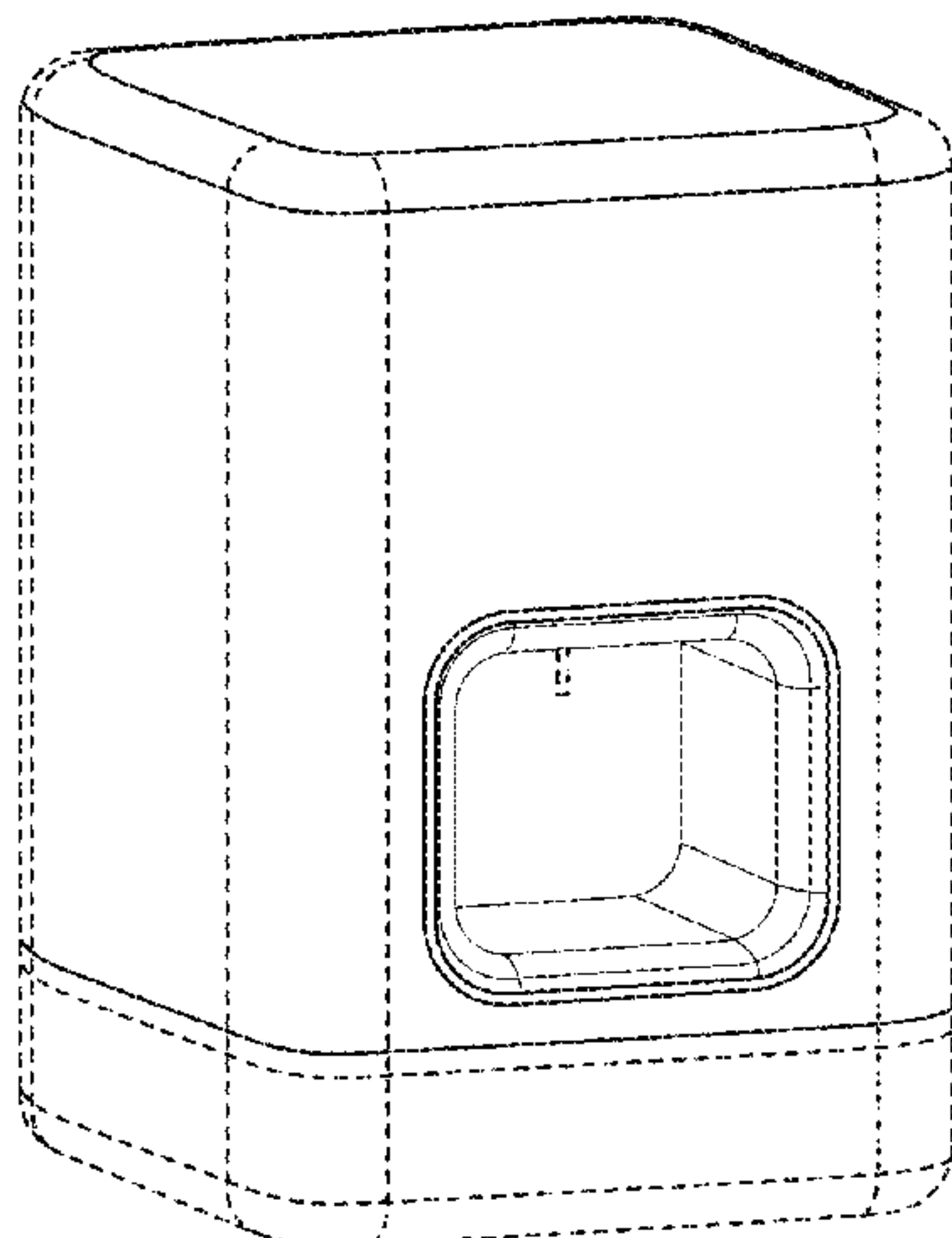

(56)

References Cited

U.S. PATENT DOCUMENTS

D474,280 S 5/2003 Niedbala et al.
 D479,086 S 9/2003 Rivard et al.
 D485,566 S 1/2004 Ledingham et al.
 D489,215 S 5/2004 Honan et al.
 D544,299 S 6/2007 Schaffeld et al.
 D549,755 S 8/2007 Wietgreffe et al.
 D553,897 S * 10/2007 De' Longhi D7/309
 D554,930 S * 11/2007 Lavy D7/307
 D556,226 S 11/2007 Jennings et al.
 D564,378 S 3/2008 Kaushal et al.
 D564,924 S 3/2008 Kaushal et al.
 D569,526 S 5/2008 Duffy et al.
 D584,097 S 1/2009 Lam
 D597,605 S * 8/2009 Davis D20/1
 D612,503 S 3/2010 Johnston et al.
 D629,907 S 12/2010 Boessneck et al.
 D639,836 S 6/2011 van Cuijk et al.
 8,008,091 B2 8/2011 Higashino et al.
 D645,971 S 9/2011 Taylor et al.
 D647,398 S 10/2011 Winkler
 D650,090 S 12/2011 Odeh
 D650,091 S 12/2011 Odeh
 D650,911 S 12/2011 Odeh
 8,162,210 B2 4/2012 McInerney et al.
 8,206,025 B2 6/2012 Natarajan
 8,240,513 B2 8/2012 Voskuil et al.
 8,256,647 B2 9/2012 Engels et al.
 8,297,482 B2 10/2012 Hill
 D670,133 S 11/2012 Caswell et al.
 D675,335 S 1/2013 Feuerabend et al.
 8,353,690 B2 1/2013 Hogan et al.
 D681,231 S 4/2013 Steinhauer et al.
 D681,232 S 4/2013 Benarieh et al.
 D682,432 S 5/2013 Khan et al.
 D684,457 S 6/2013 Salow et al.
 D684,614 S 6/2013 Bergamini
 D684,615 S 6/2013 Bergamini
 8,467,981 B2 6/2013 Mukherjee et al.
 8,496,032 B2 7/2013 Miller et al.
 8,517,596 B2 8/2013 Natarajan
 D689,169 S 9/2013 Engels
 D689,193 S 9/2013 Shinohara et al.
 D698,038 S 1/2014 Davis et al.
 8,783,516 B2 7/2014 Baak et al.
 D710,642 S * 8/2014 Broen D7/306
 D713,666 S * 9/2014 Van Baelen D7/306
 D714,847 S * 10/2014 Broen D15/89
 D718,462 S 11/2014 Cook et al.
 D719,404 S 12/2014 Manly et al.
 D720,180 S 12/2014 Manly et al.
 D721,247 S 1/2015 Manly et al.
 D721,248 S 1/2015 Manly et al.
 D722,463 S 2/2015 Manly et al.
 D723,317 S 3/2015 Manly et al.
 9,022,039 B2 5/2015 Hearn
 D731,662 S 6/2015 Khan et al.
 D737,625 S 9/2015 Caswell et al.

D737,702 S 9/2015 Selberg et al.
 D738,153 S * 9/2015 Brook D7/309
 9,120,067 B2 9/2015 Miyata et al.
 9,140,597 B2 9/2015 Mukherjee et al.
 D742,170 S * 11/2015 Kunz D7/309
 D742,687 S * 11/2015 Kunz D7/309
 D743,728 S * 11/2015 Tomasson D7/306
 9,174,179 B2 11/2015 Bertucci et al.
 D749,674 S * 2/2016 Ibbett D20/1
 9,271,528 B2 3/2016 Liu
 D762,750 S 8/2016 Jiang et al.
 D762,860 S 8/2016 He et al.
 D763,614 S 8/2016 Han et al.
 9,474,725 B1 10/2016 Reillo et al.
 D773,684 S 12/2016 Ketterer et al.
 D775,364 S 12/2016 Ray et al.
 D783,178 S 4/2017 Mead et al.
 D784,549 S 4/2017 Brooks et al.
 D789,198 S 6/2017 Ngo et al.
 D791,846 S 7/2017 Zhang
 D792,165 S 7/2017 Cauwood et al.
 9,730,911 B2 8/2017 Verzura et al.
 9,745,182 B2 8/2017 Hogan
 2006/0280029 A1 12/2006 Garstecki et al.
 2007/0258849 A1 11/2007 Kent
 2008/0264518 A1 10/2008 Collins
 2010/0276452 A1 11/2010 Vesborg et al.
 2011/0264285 A1 10/2011 Mattos, Jr. et al.
 2012/0035761 A1 2/2012 Tilton et al.
 2012/0123588 A1 5/2012 Cloran et al.
 2012/0128549 A1 5/2012 Zhou et al.
 2012/0167906 A1 7/2012 Gysland
 2012/0248137 A1 10/2012 Baak et al.
 2012/0248147 A1 10/2012 Krom et al.
 2012/0250451 A1 10/2012 Post et al.
 2013/0061981 A1 3/2013 Bragg et al.
 2013/0231774 A1 9/2013 Tilton et al.
 2014/0166028 A1 6/2014 Fuisz et al.
 2015/0053719 A1 2/2015 Hogan
 2015/0083146 A1 3/2015 Goldman et al.
 2015/0157053 A1 6/2015 Mayor
 2015/0247786 A1 9/2015 Parker et al.
 2015/0336689 A1 11/2015 Brown et al.
 2016/0038940 A1 2/2016 Babcock
 2016/0073677 A1 3/2016 Kappel et al.
 2016/0153433 A1 6/2016 Hogan
 2016/0200463 A1 7/2016 Hodges et al.
 2016/0250270 A1 9/2016 Wendschuh et al.
 2016/0310443 A1 10/2016 Reillo et al.
 2016/0367479 A1 12/2016 Reillo et al.
 2017/0020945 A1 1/2017 Reillo et al.
 2017/0233114 A1 8/2017 Christensen et al.
 2017/0266153 A1 9/2017 Levy et al.

FOREIGN PATENT DOCUMENTS

WO 2017100063 A2 6/2017
 WO 2017100369 A1 6/2017

* cited by examiner

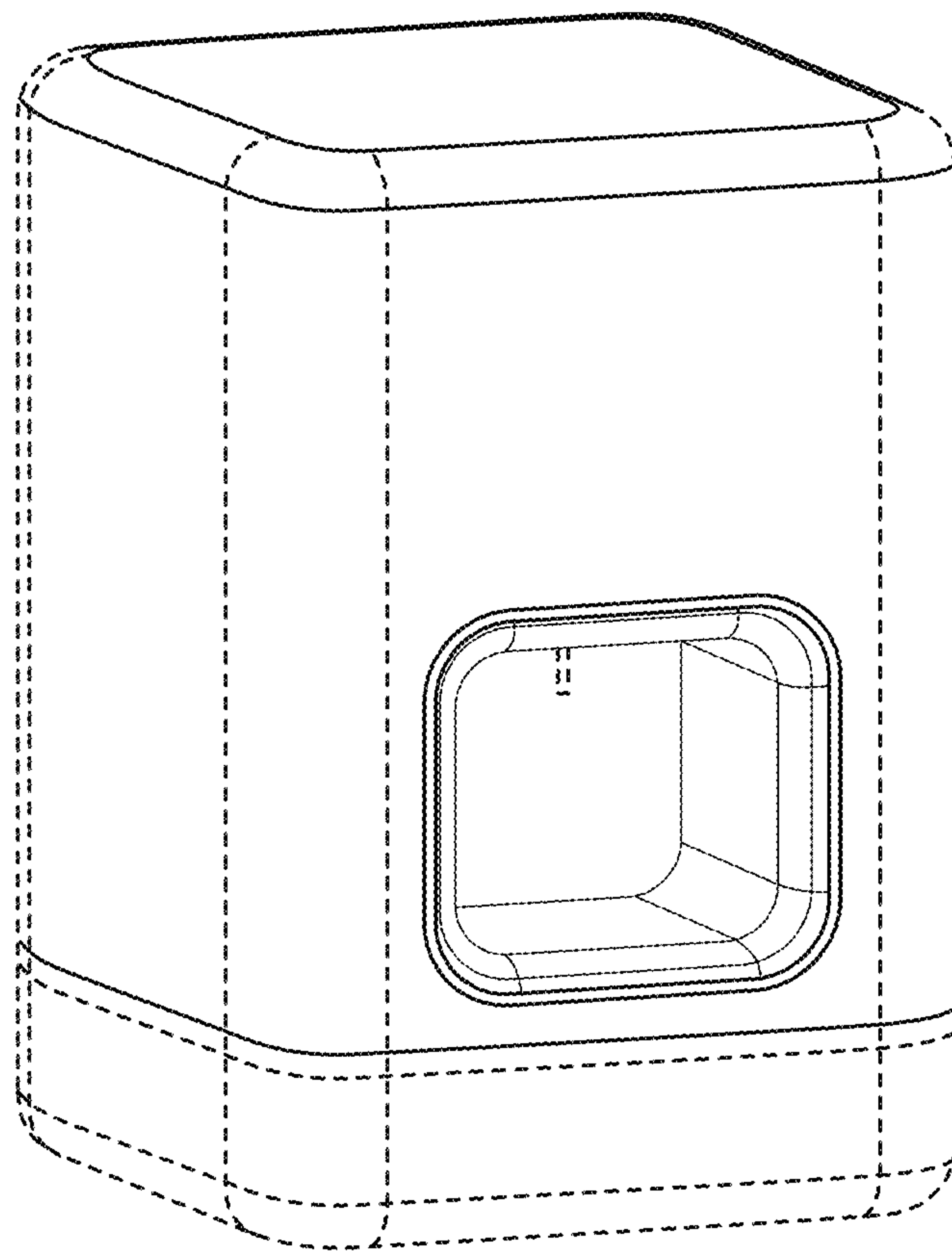

FIG. 1

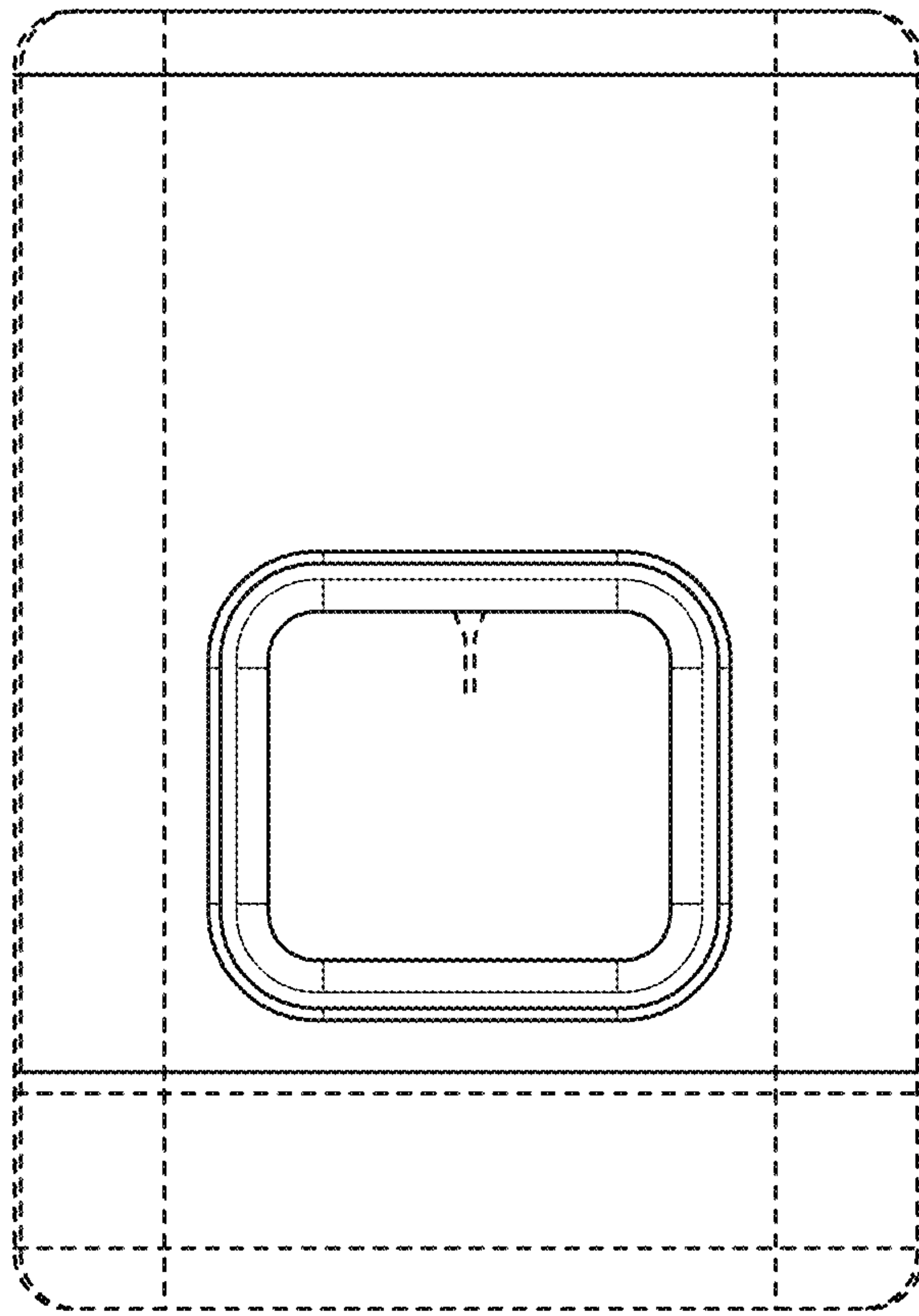

FIG. 2

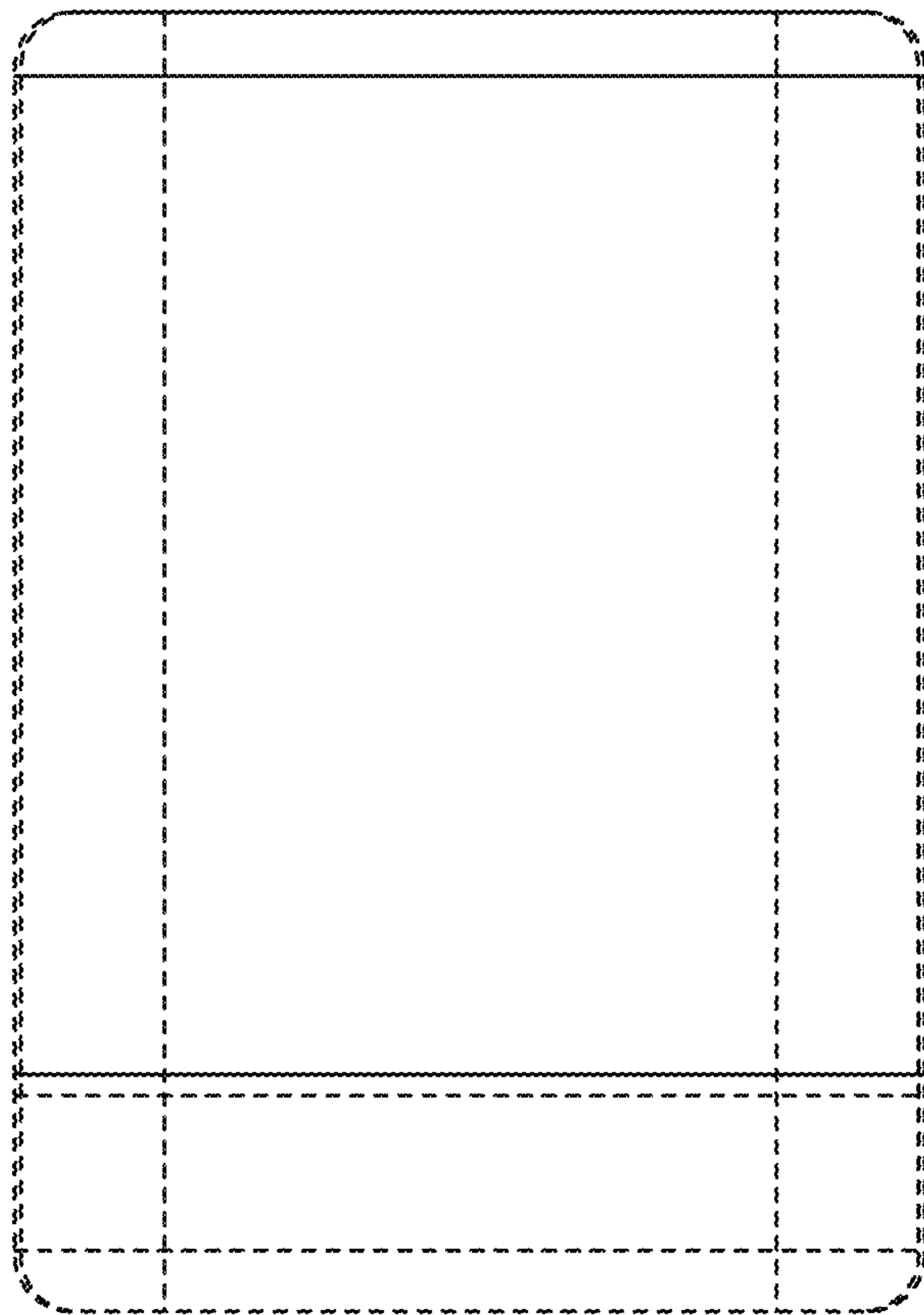

FIG. 3

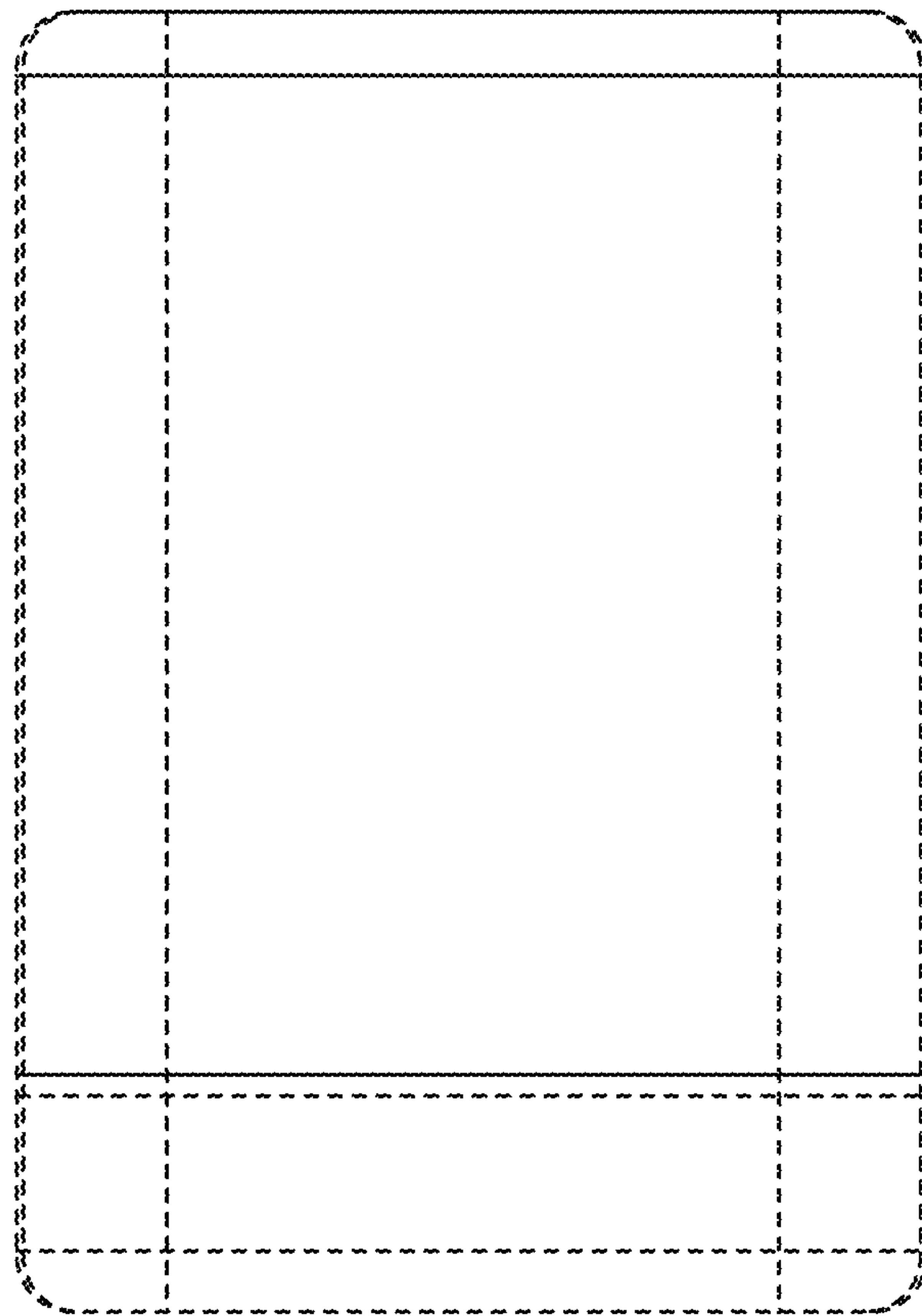

FIG. 4

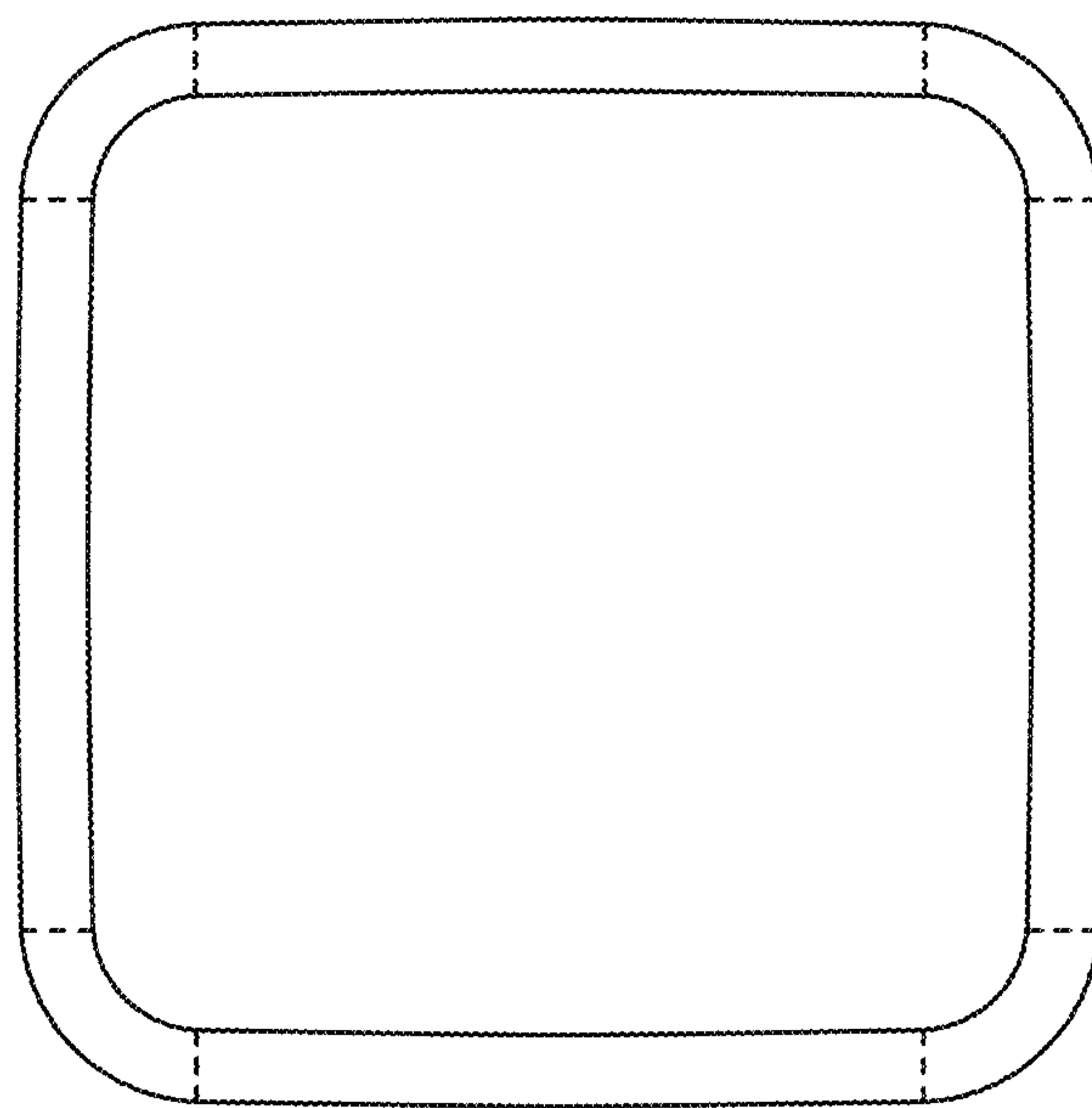

FIG. 5

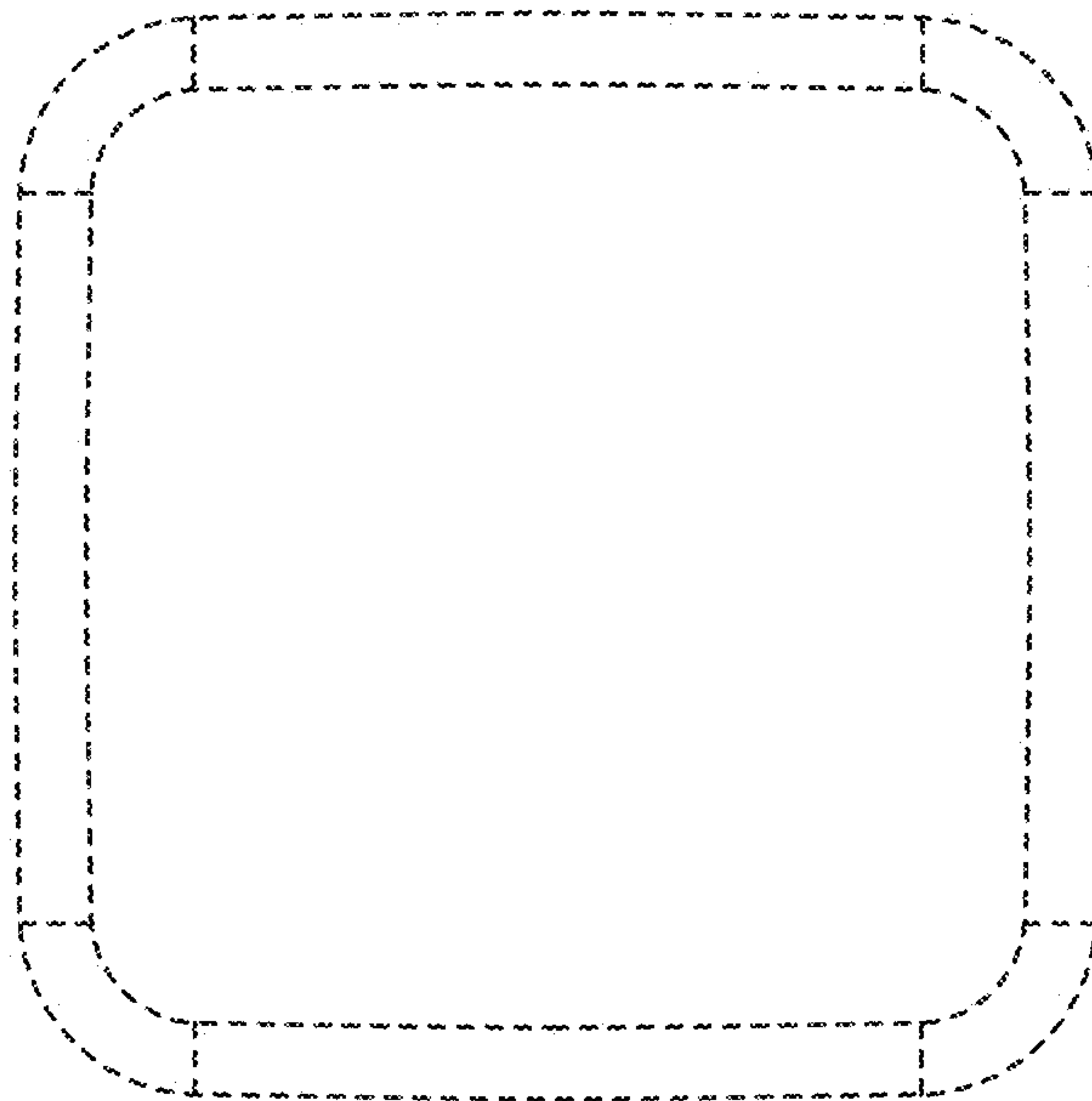

FIG. 6