



US00D802977S

(12) **United States Design Patent** (10) **Patent No.:** **US D802,977 S**
Bodum (45) **Date of Patent:** **** Nov. 21, 2017**

(54) **COFFEE MAKER**
(71) Applicant: **PI-Design AG**, Triengen (CH)
(72) Inventor: **Jorgen Bodum**, Meggen (CH)
(73) Assignee: **PI-Design AG**, Triengen (CH)
(**) Term: **15 Years**
(21) Appl. No.: **29/565,620**
(22) Filed: **May 23, 2016**

D563,713 S * 3/2008 Bodum D7/317
D565,887 S * 4/2008 Bodum D7/317
D566,454 S * 4/2008 Bodum D7/317
D567,006 S * 4/2008 Bodum D7/317
D594,267 S * 6/2009 Bodum D7/317
D594,687 S * 6/2009 Bodum D7/300
D610,860 S * 3/2010 Bodum D7/317
D612,660 S * 3/2010 Bodum D7/317
D628,846 S * 12/2010 Bodum D7/317
D652,246 S * 1/2012 Bodum D7/317
D654,756 S * 2/2012 Bodum D7/317
D680,792 S * 4/2013 Bodum D7/317
8,695,486 B2 * 4/2014 Bodum A47J 31/20
99/297
D718,566 S * 12/2014 Lu D7/317

(30) **Foreign Application Priority Data**

Nov. 26, 2015 (WO) DM/088558

(51) **LOC (10) Cl.** **07-01**
(52) **U.S. Cl.**
USPC **D7/317; D7/319**
(58) **Field of Classification Search**
USPC D7/316, 317, 318, 319, 303, 302, 312,
D7/322, 321, 600; D10/46.2; D9/524,
D9/526, 527; 222/573; D23/212, 211.2
CPC B65D 23/06; B65D 47/06; B67D 1/16;
A47G 19/00
See application file for complete search history.

(56) **References Cited**

U.S. PATENT DOCUMENTS

D372,627 S * 8/1996 Ireland 366/256
D377,132 S * 1/1997 Jørgensen D7/318
D383,639 S * 9/1997 Jørgensen D7/318
D384,540 S * 10/1997 Joergensen D7/317
D386,351 S * 11/1997 Joergensen D7/317
D405,642 S * 2/1999 Toriba D7/317
D448,603 S * 10/2001 Yeh D7/317
6,945,014 B1 * 9/2005 Quann A47J 31/005
53/432
D557,978 S * 12/2007 Bodum D7/397
D559,028 S * 1/2008 Appleton D7/317
D560,951 S * 2/2008 Appleton D7/317

OTHER PUBLICATIONS

Select portions of Bodum Collection Catalogue, Jan. 2015, 6 pages.

Primary Examiner — Marianne Pandozzi
(74) *Attorney, Agent, or Firm* — McDonnell Boehnen
Hulbert & Berghoff LLP

(57) **CLAIM**

The ornamental design for a coffee maker, as shown and described.

DESCRIPTION

FIG. 1 is a perspective view of a coffee maker showing my new design;
FIG. 2 is a front view thereof;
FIG. 3 is a rear view thereof;
FIG. 4 is a left side view thereof;
FIG. 5 is a right side view thereof;
FIG. 6 is a top view thereof; and,
FIG. 7 is a bottom view thereof.
The broken lines in the drawing depict portions of the coffee maker that form no part of the claimed design.

1 Claim, 7 Drawing Sheets

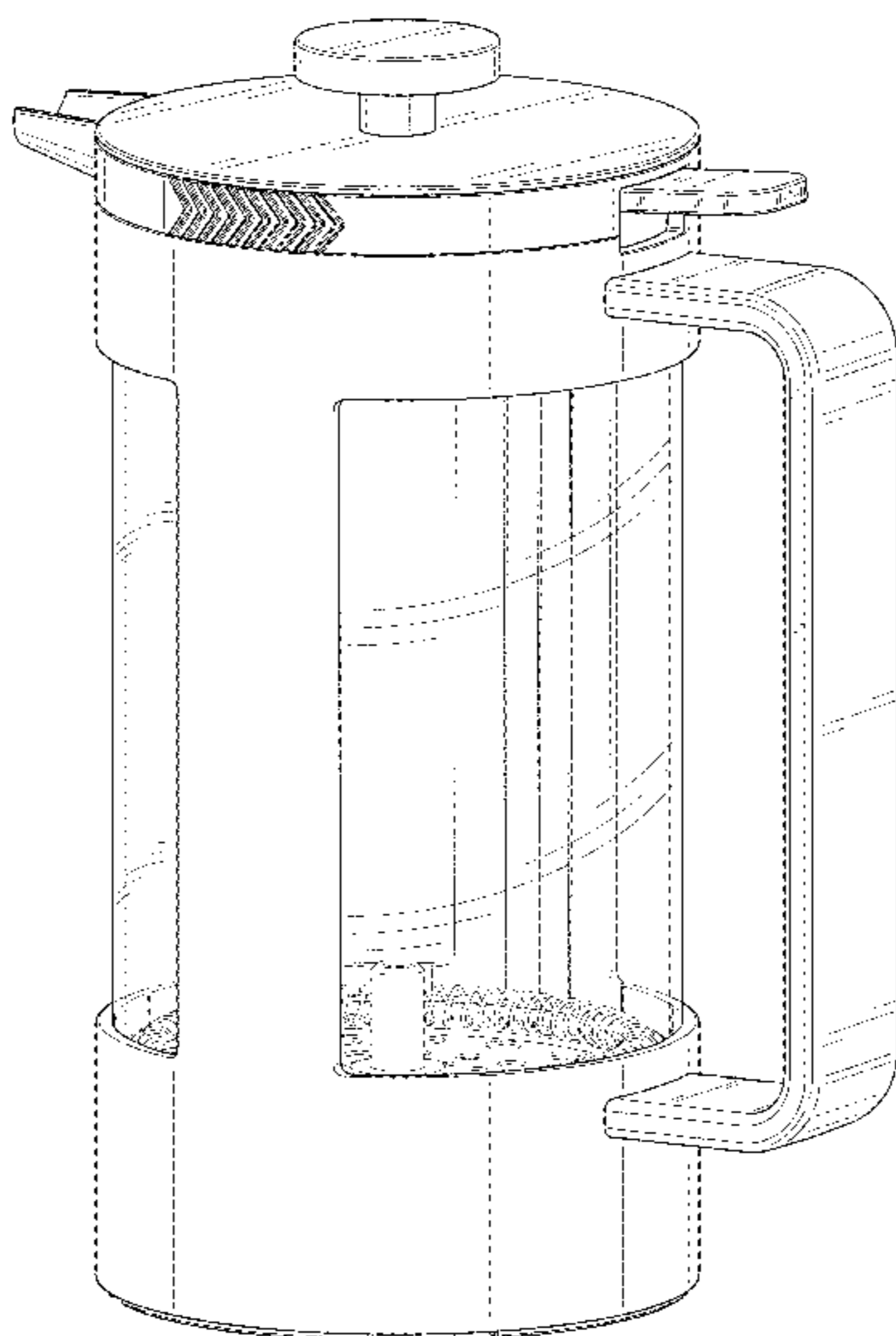

(56)

References Cited

U.S. PATENT DOCUMENTS

D718,567 S *	12/2014	Lu	D7/317
9,108,773 B2 *	8/2015	Bodum	A47J 31/4407
2005/0120886 A1 *	6/2005	Chen	A47J 31/20 99/279
2011/0088561 A1 *	4/2011	Bodum	A47J 31/20 99/297
2012/0216682 A1 *	8/2012	Bodum	A47J 31/20 99/297

* cited by examiner

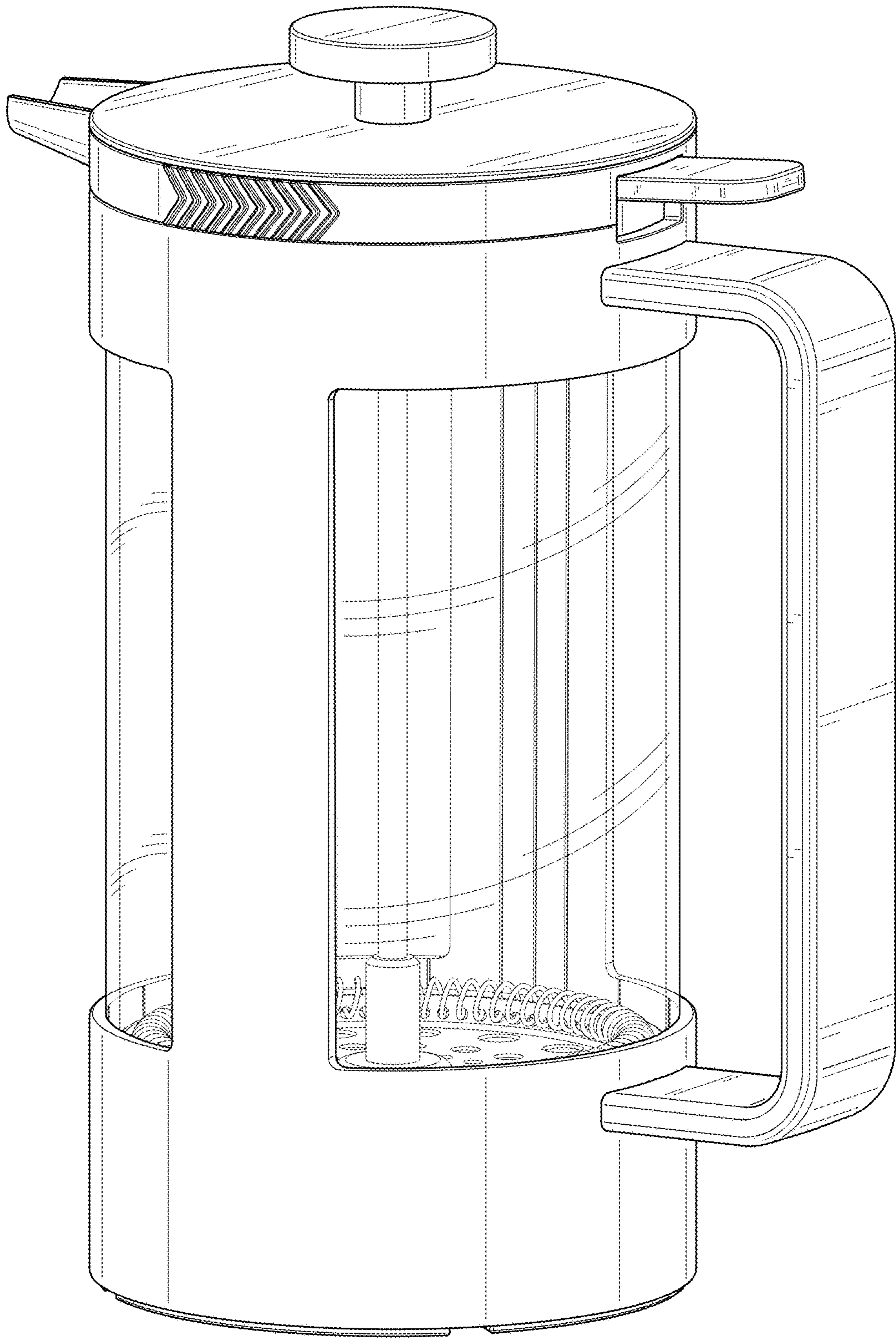

FIG. 1

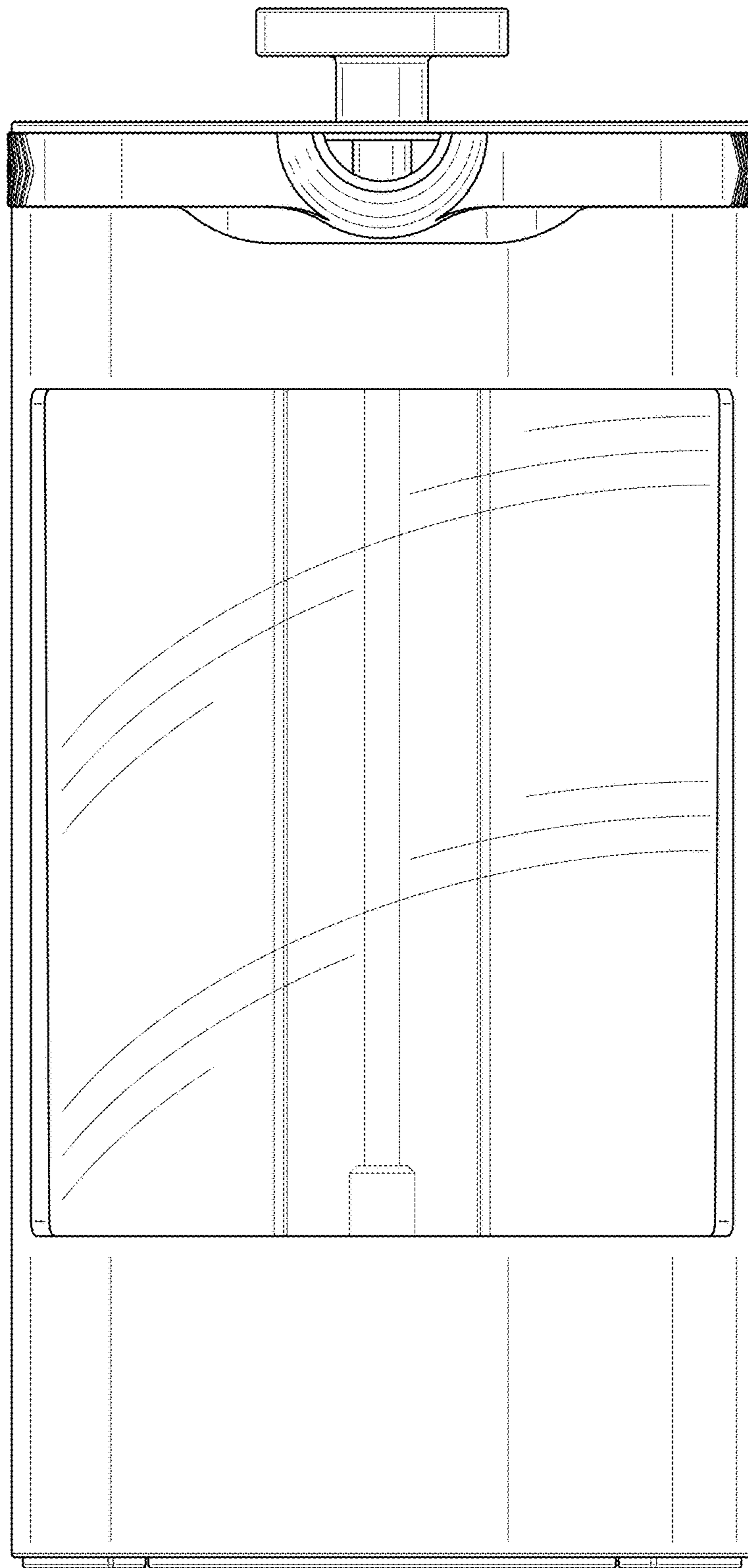

FIG. 2

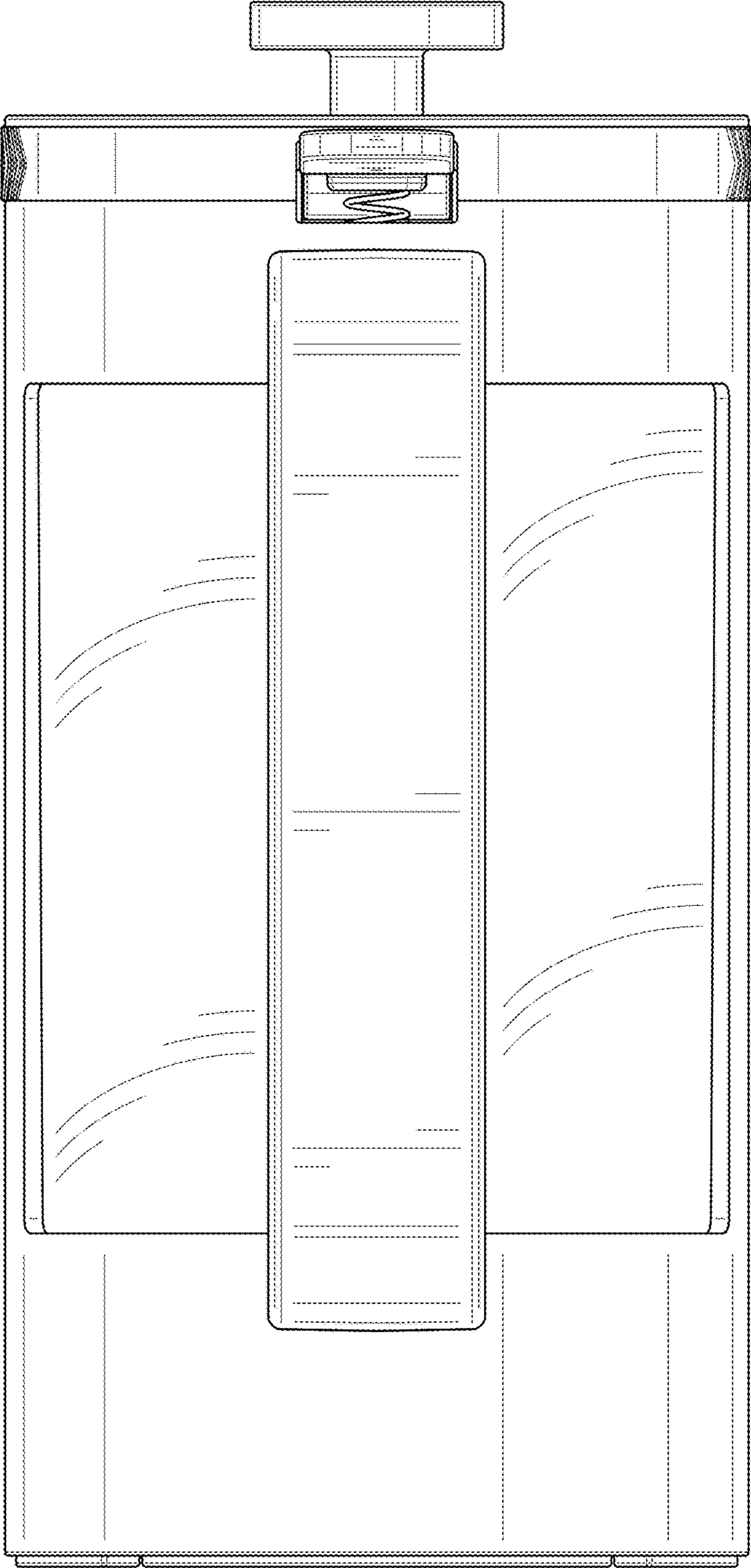

FIG. 3

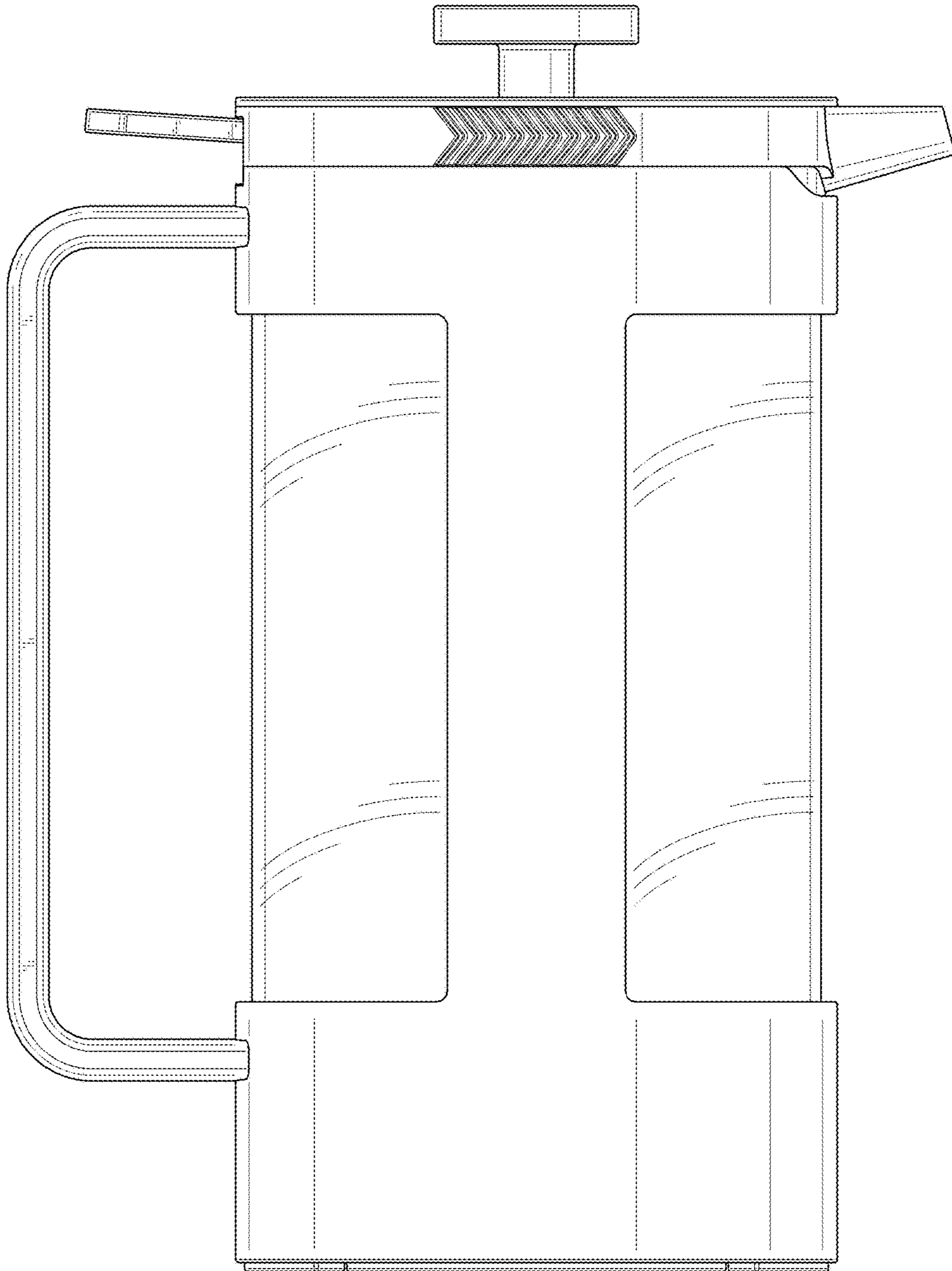

FIG. 4

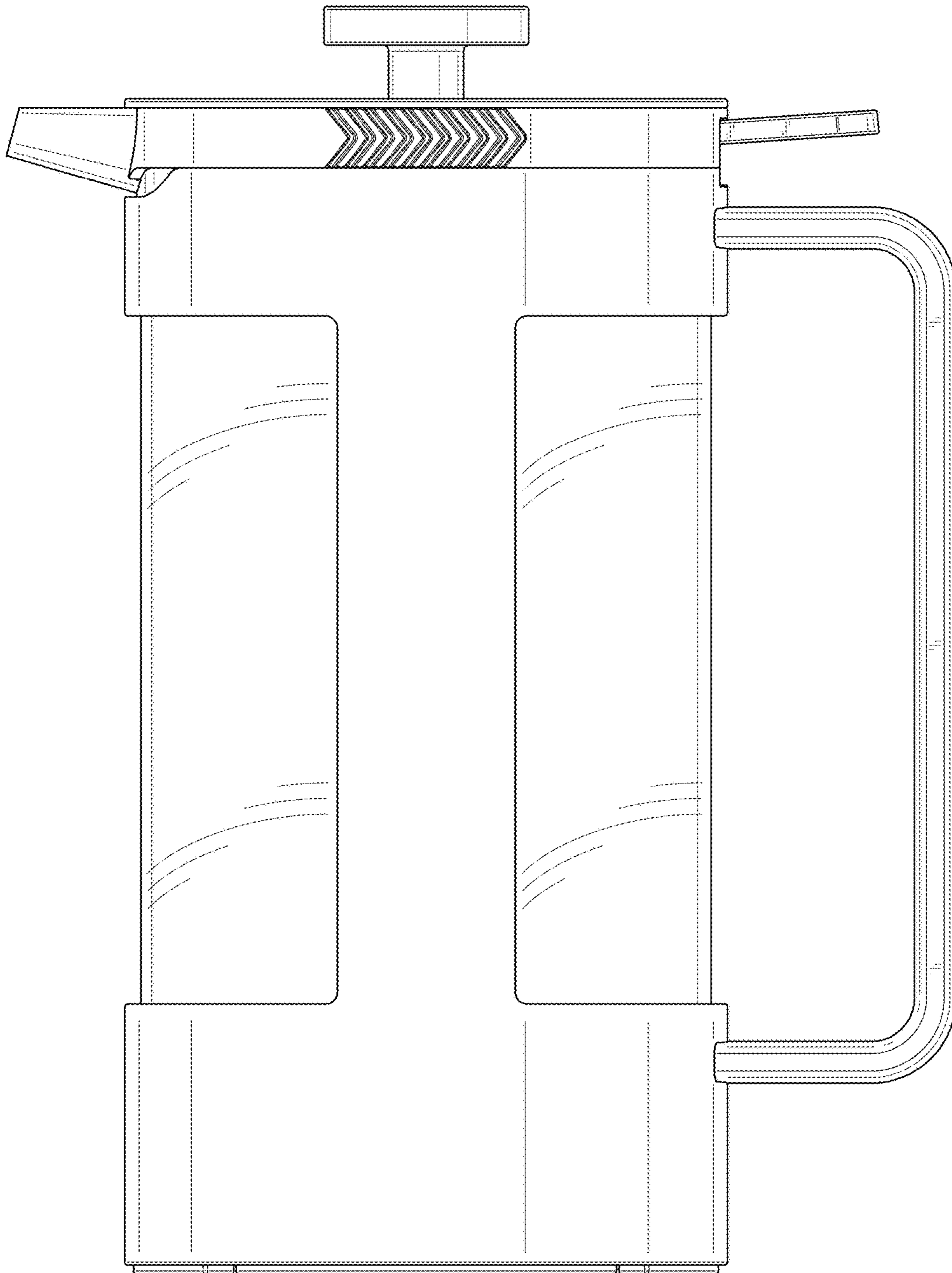

FIG. 5

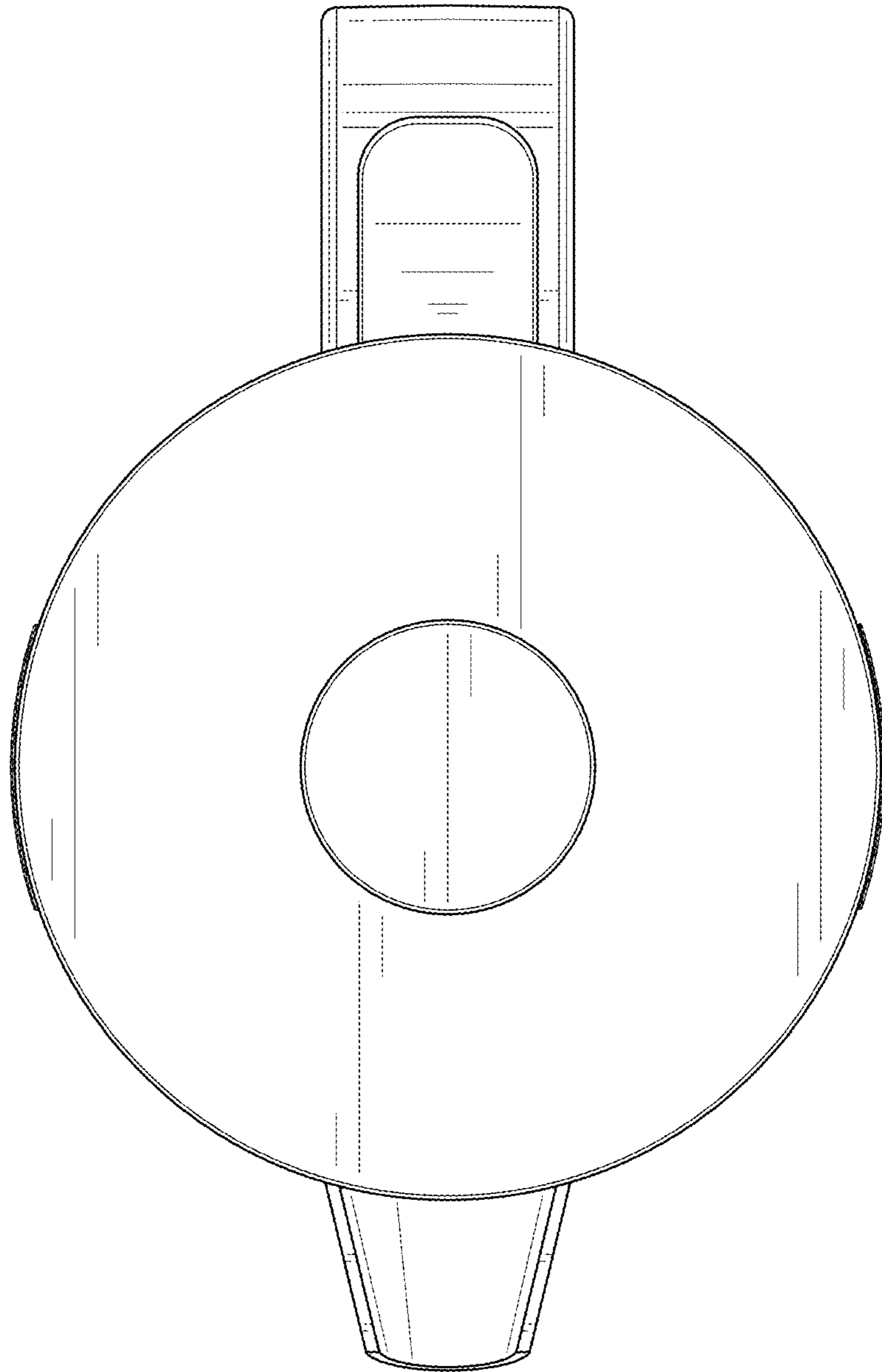

FIG. 6

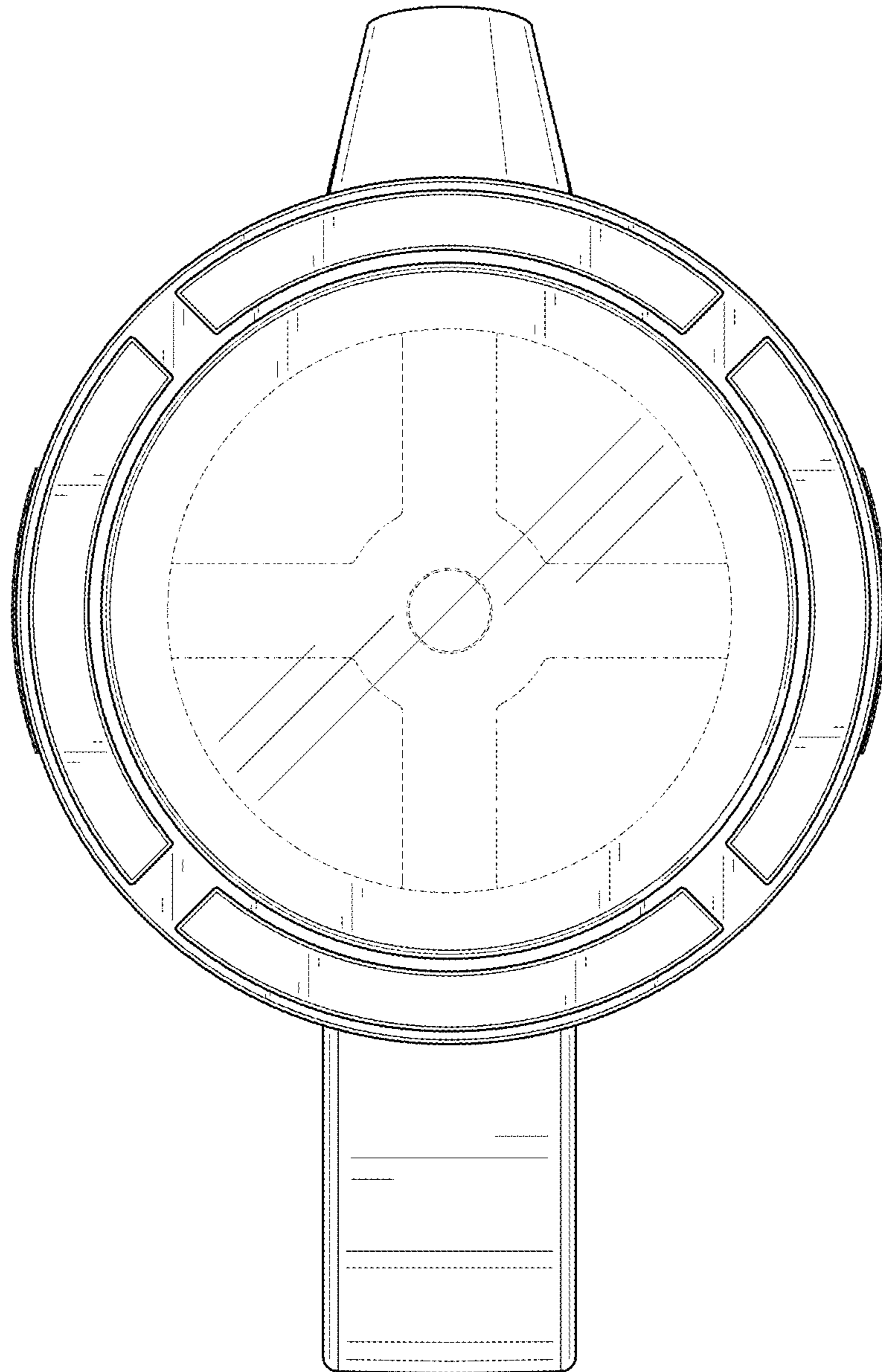

FIG. 7