



US00D802911S

(12) **United States Design Patent** (10) **Patent No.:** **US D802,911 S**
Wang (45) **Date of Patent:** **** Nov. 21, 2017**

(54) **STORAGE BAG**

(71) Applicant: **Wen-Tsan Wang**, Taipei (TW)

(72) Inventor: **Wen-Tsan Wang**, Taipei (TW)

(**) Term: **15 Years**

(21) Appl. No.: **29/566,700**

(22) Filed: **Jun. 2, 2016**

(51) **LOC (10) Cl.** **03-01**

(52) **U.S. Cl.**
USPC **D3/201**

(58) **Field of Classification Search**
USPC D3/201, 215–216, 232, 234, 244,
D3/255–256, 271.9, 273–296, 299–301,
D3/303, 318–320, 327, 383, 246;
383/104, 120, 6, 8, 12, 17, 97, 10, 119,
383/15, 99; 224/148.6, 148.7;
D32/35–37; 206/315.1, 305.3; D7/607,
D7/709
CPC A45C 5/00; A45C 1/00; A45C 1/02; A45C
1/024; A45C 1/08; A45C 3/10; A45C
2011/003; A45C 7/00; A45C 7/0018;
A45C 7/0054; A45C 7/0059; A45C
7/0095; A45C 2200/00; A45C 13/00;
A45C 13/001; A45C 13/002; A45C
13/08; A45C 11/24; A45C 11/00; A45C
11/20; A45C 13/28; A45F 3/00; A45F
3/02; A45F 3/04; A45F 3/06;

(Continued)

(56) **References Cited**

U.S. PATENT DOCUMENTS

D509,059 S * 9/2005 Hayes D3/246
D586,631 S * 2/2009 Lown D7/709

(Continued)

FOREIGN PATENT DOCUMENTS

EM 003188077-0001 * 6/2016

OTHER PUBLICATIONS

Large Neoprene Lunch Bag, posted at Amazon.com, available Nov. 10, 2015, © 1996-2017, Amazon.com, Inc., [online], [site visited May 24, 2017]. Available from Internet, <URL:https://www.amazon.com/LARGE-Neoprene-Lunch-Bag-Insulated/dp/B017SB0BQG/ref=sr_1_5?ie=UTF8&qid=1495717852&sr=8-5&keywords=neoprene+lunch+bag>.*

(Continued)

Primary Examiner — Anhdao Doan

Assistant Examiner — Mary Malley

(74) *Attorney, Agent, or Firm* — Leong C. Lei

(57) **CLAIM**

The ornamental design for a storage bag, as shown and described.

DESCRIPTION

FIG. 1 is a perspective view of a storage bag showing my new design;
FIG. 2 is a front elevational view thereof;
FIG. 3 is a rear elevational view thereof;
FIG. 4 is a left side view thereof;
FIG. 5 is a right side view thereof;
FIG. 6 is a top plan view thereof;
FIG. 7 is a bottom plan view thereof;
FIG. 8 is another perspective view thereof, showing the storage bag in use with the side gussets tucked inwards, the handles extended and parallel to one another, and the side walls flattened;
FIG. 9 is another perspective view thereof, showing the storage bag in use with the side gussets extended outwards, the handles extended and parallel to one another, and the side walls flattened;
FIG. 10 is another perspective view thereof, with the top opened;
FIG. 11 is another perspective view thereof, with the top in half opened position;
FIG. 12 is another perspective view thereof, with the top in half opened position; and,

(Continued)

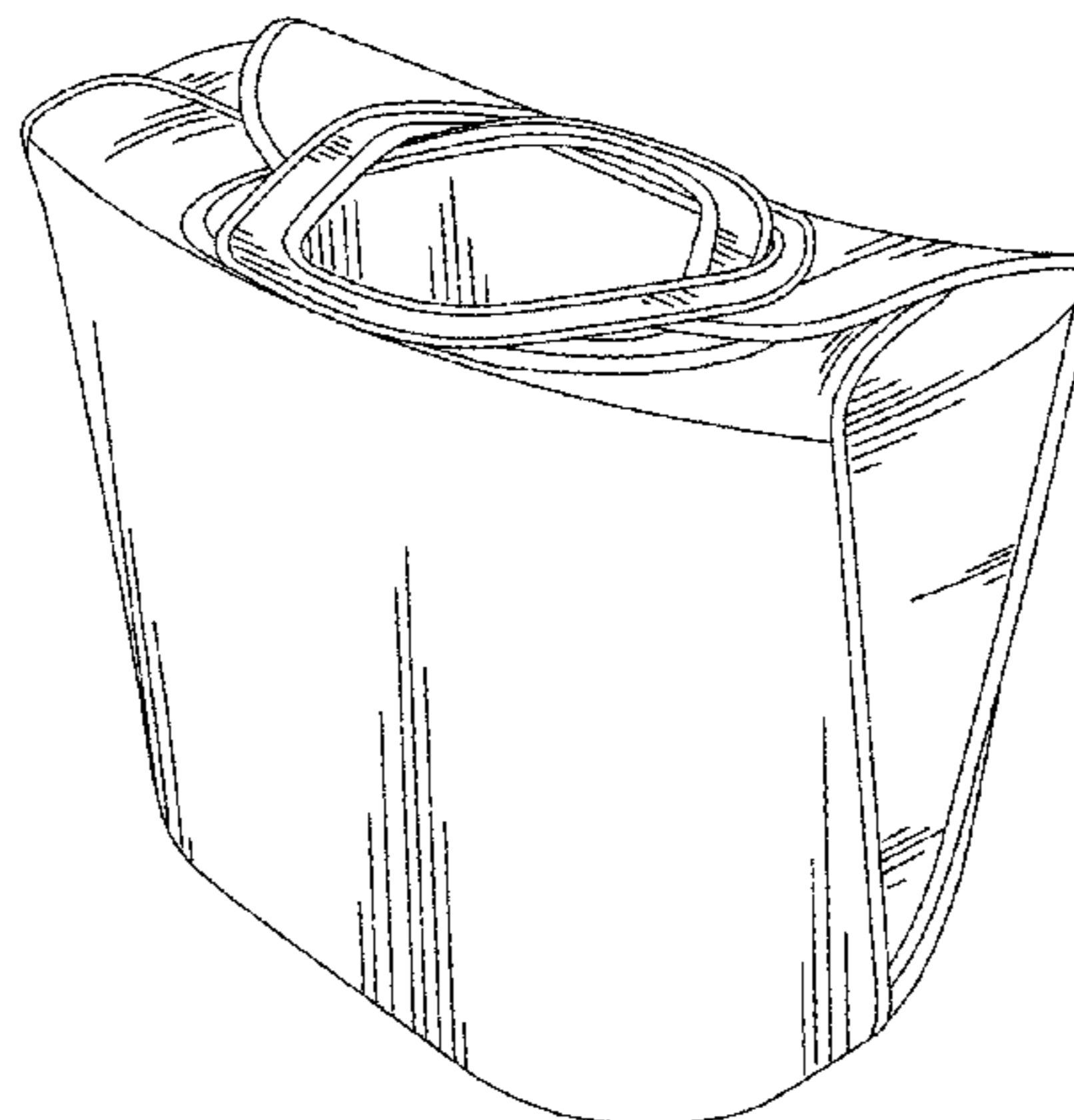

FIG. 13 is another perspective view thereof, with the top closed.

1 Claim, 7 Drawing Sheets

(58) **Field of Classification Search**

CPC A45F 2003/001; A45F 2003/002; A45F 2003/006; A45F 2200/00; A45F 2200/0525; A45F 5/00; A45F 2005/006; B65D 75/008; B65D 2313/02; B65D 33/065; B65D 33/08; A63B 47/001; A63B 55/00; A63B 55/40; A61L 9/046; A61L 9/12; F24F 2003/1689

See application file for complete search history.

(56) **References Cited**

U.S. PATENT DOCUMENTS

D592,912 S * 5/2009 Lown D3/232
 D610,885 S * 3/2010 Lown D7/709

D626,798 S * 11/2010 Swartz D3/246
 D675,892 S * 2/2013 Denzinger D7/709
 8,408,791 B1 * 4/2013 Wang B65D 33/02
 383/10
 D699,589 S * 2/2014 Wang D9/703
 D762,378 S * 8/2016 Domotor D3/233
 D771,940 S * 11/2016 Wei D3/232
 2016/0159524 A1 * 6/2016 Rosenberg B65D 33/1608
 383/8

OTHER PUBLICATIONS

Tropics Zippered Neoprene Lunch Bag, posted at 4imprint.com, available Aug. 6, 2014, © 1994-2014 4imprint Inc., [online], [site visited May 24, 2017]. Available from Internet, <URL:https://www.4imprint.com/product/123176/Tropics-Zippered-Neoprene-Lunch-Bag>.*

Klutch Neoprene Lunch Bag, posted at qualitylogoproducts.com, available Sep. 8, 2015, © 2003-2015 Quality Logo Products, Inc., [online], [site visited May 24, 2017]. Available from Internet, <URL:https://www.qualitylogoproducts.com/lunch-boxes/klutch-neoprene-lunch-bags.htm>.*

* cited by examiner

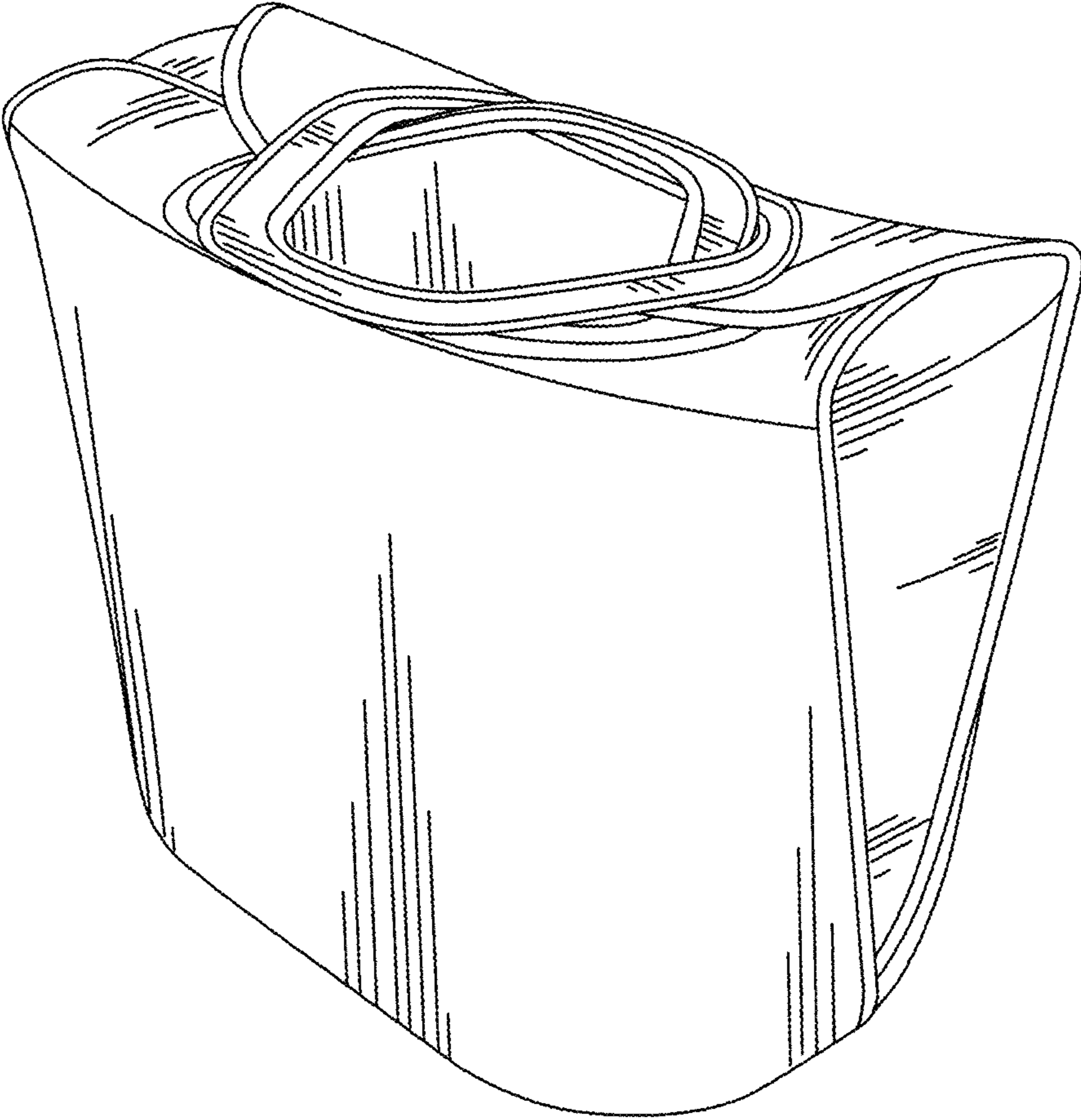

FIG. 1

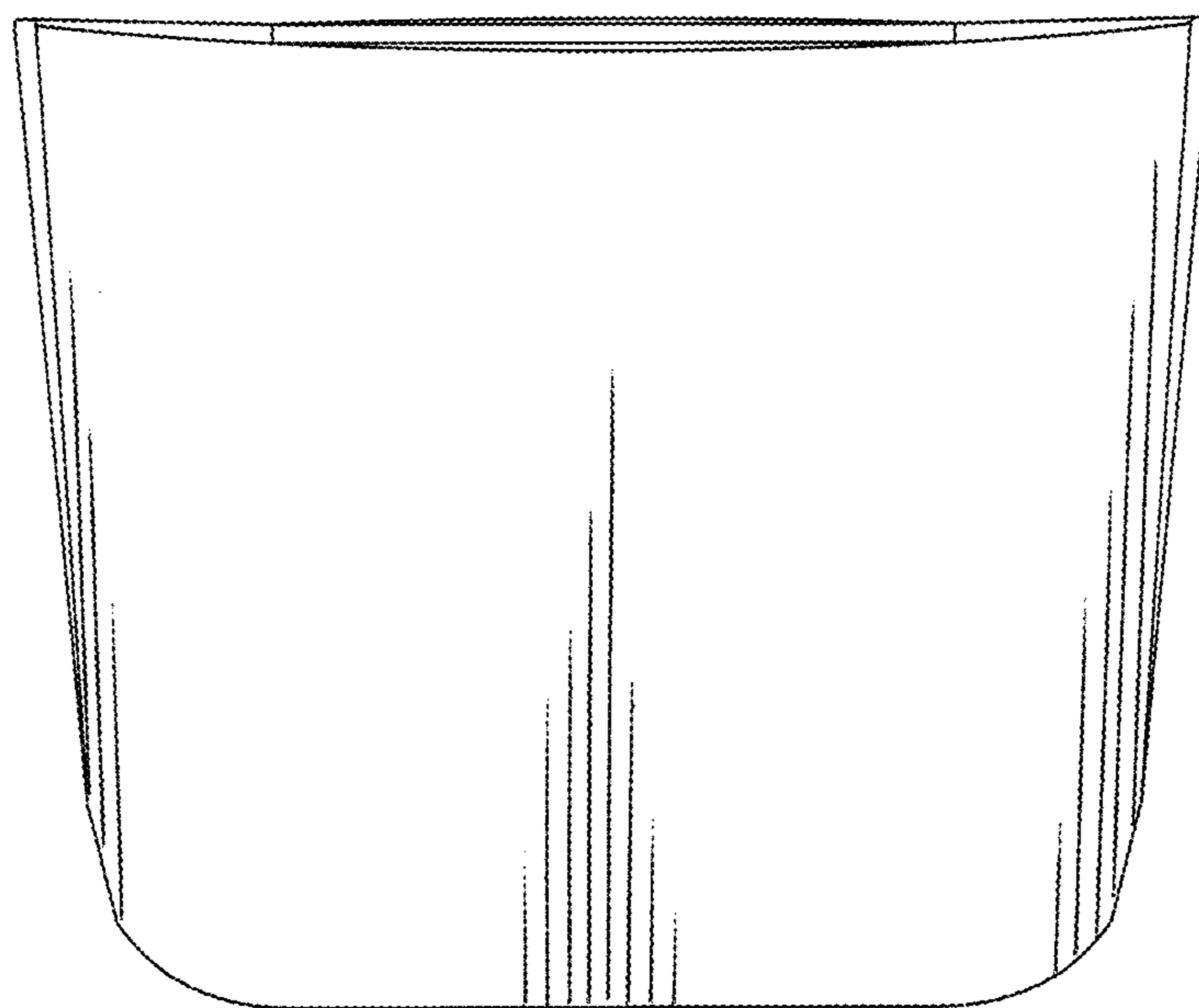

FIG. 2

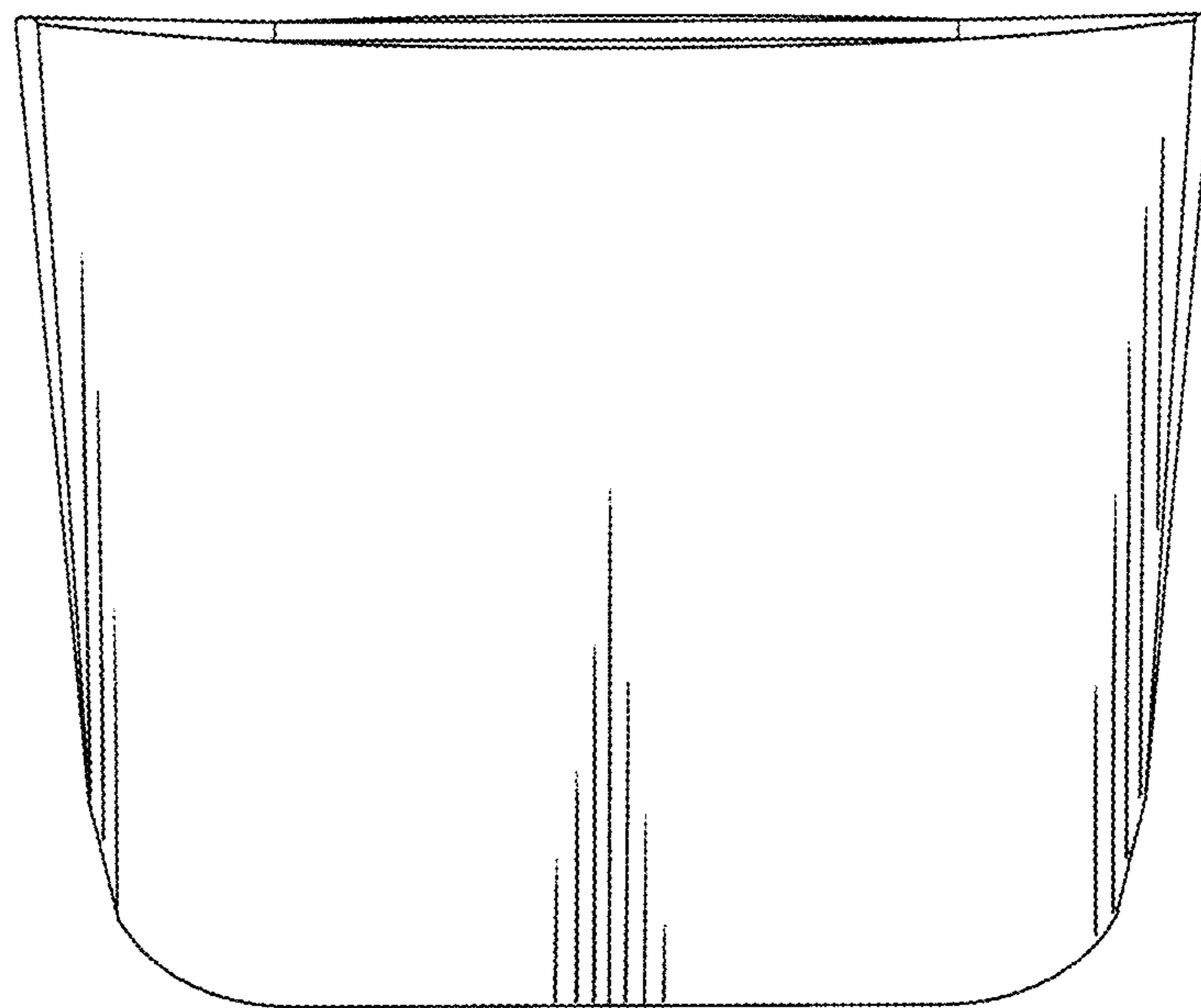

FIG. 3

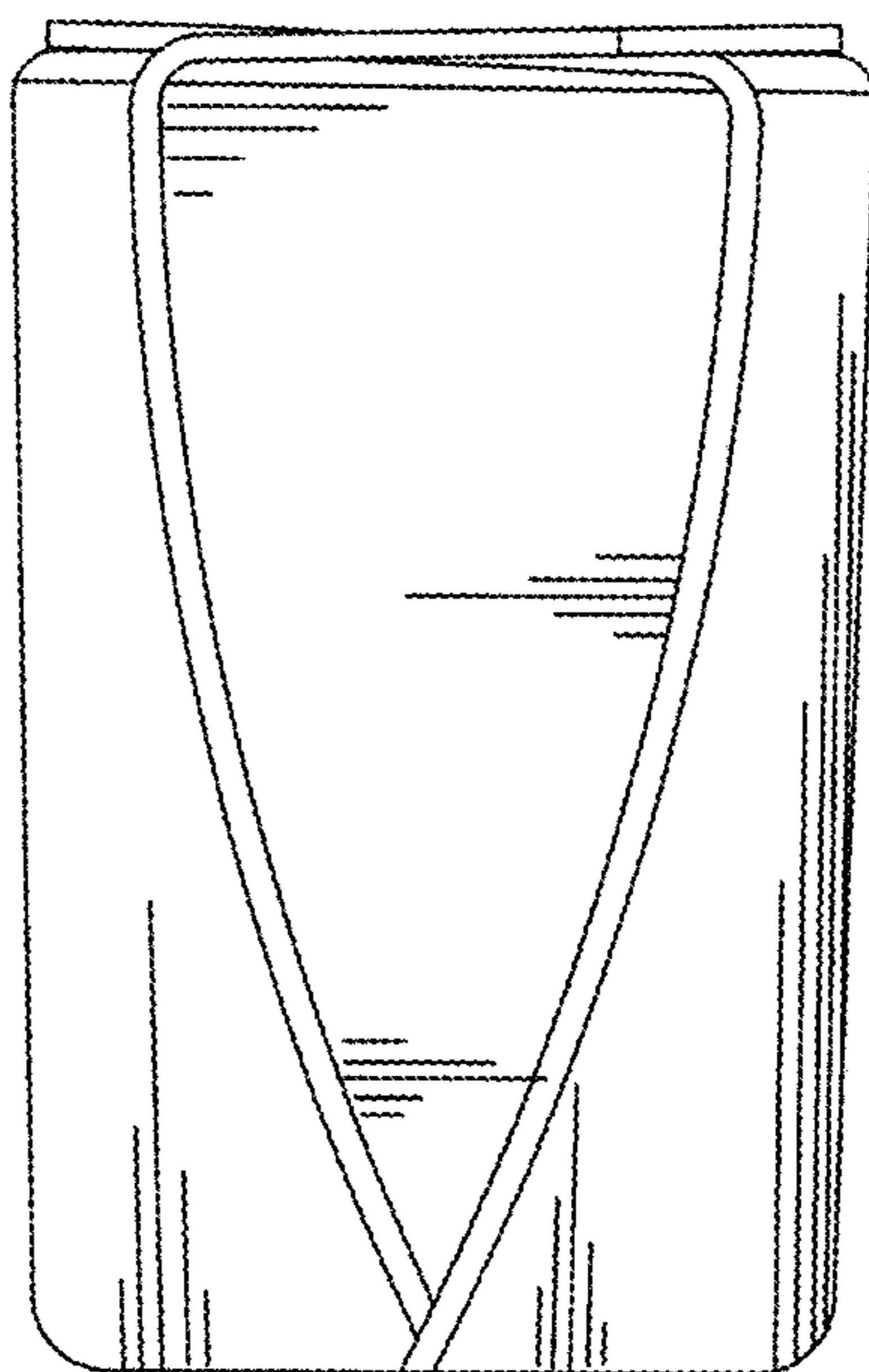

FIG. 4

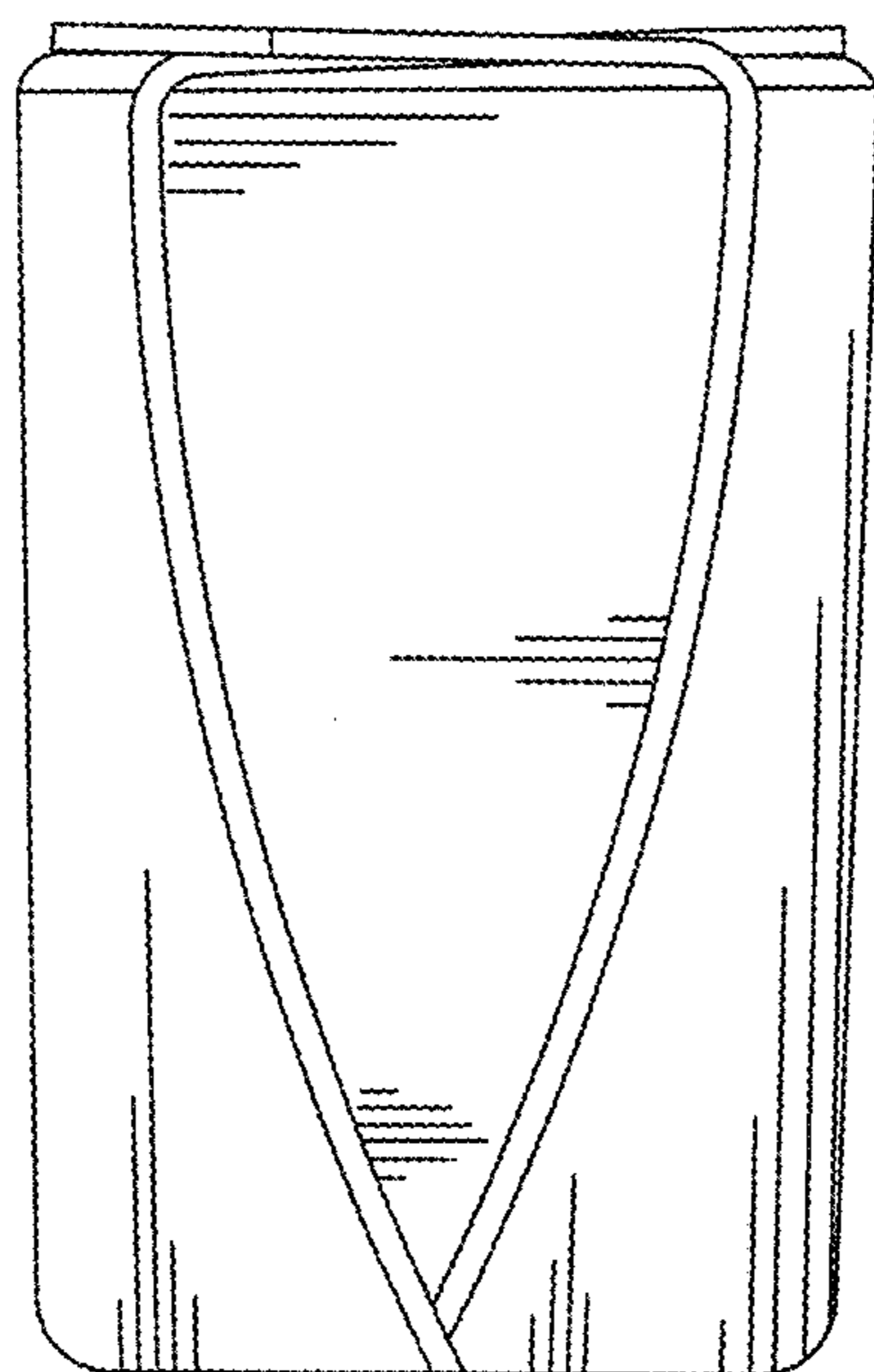

FIG. 5

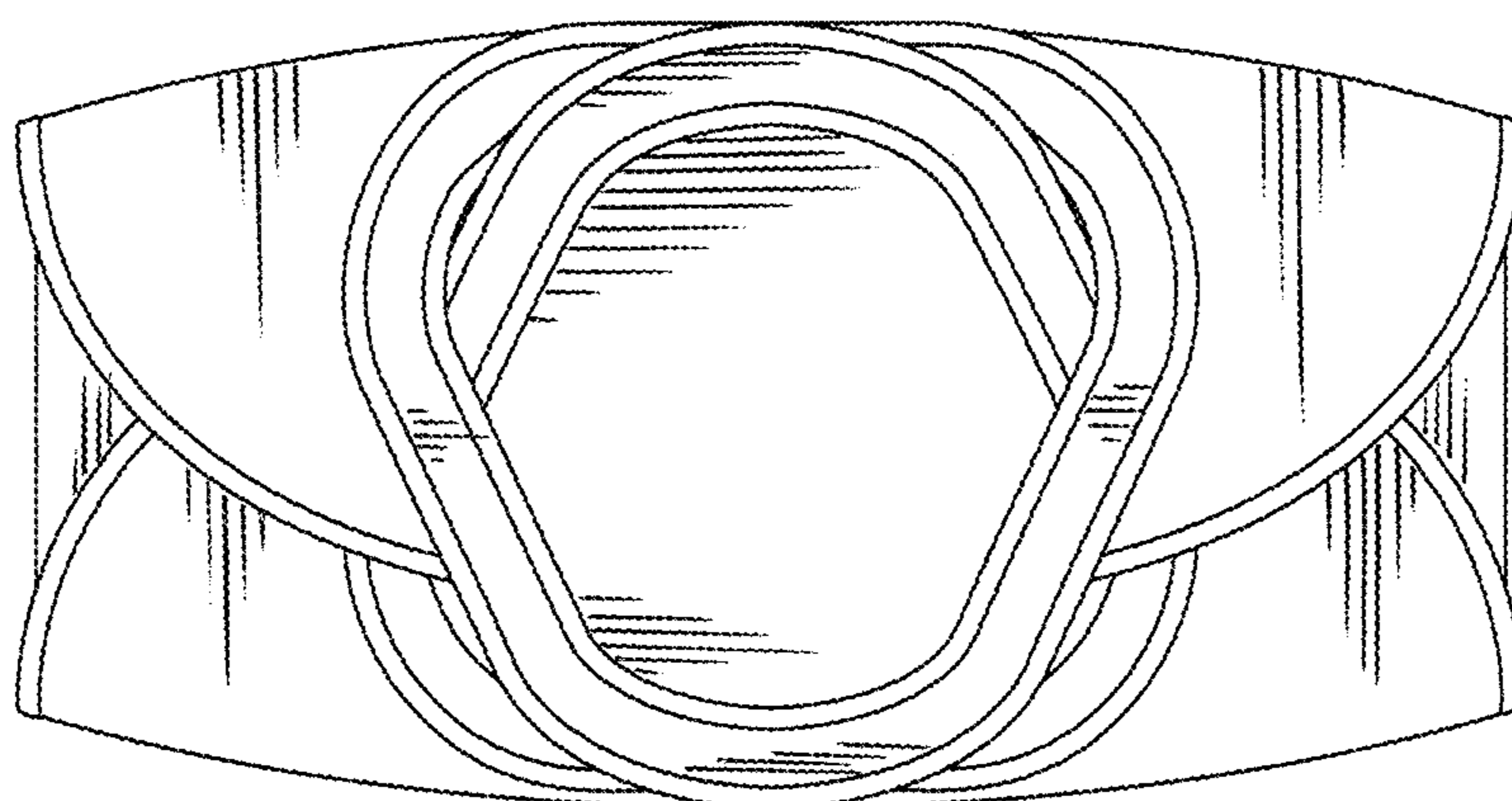

FIG. 6

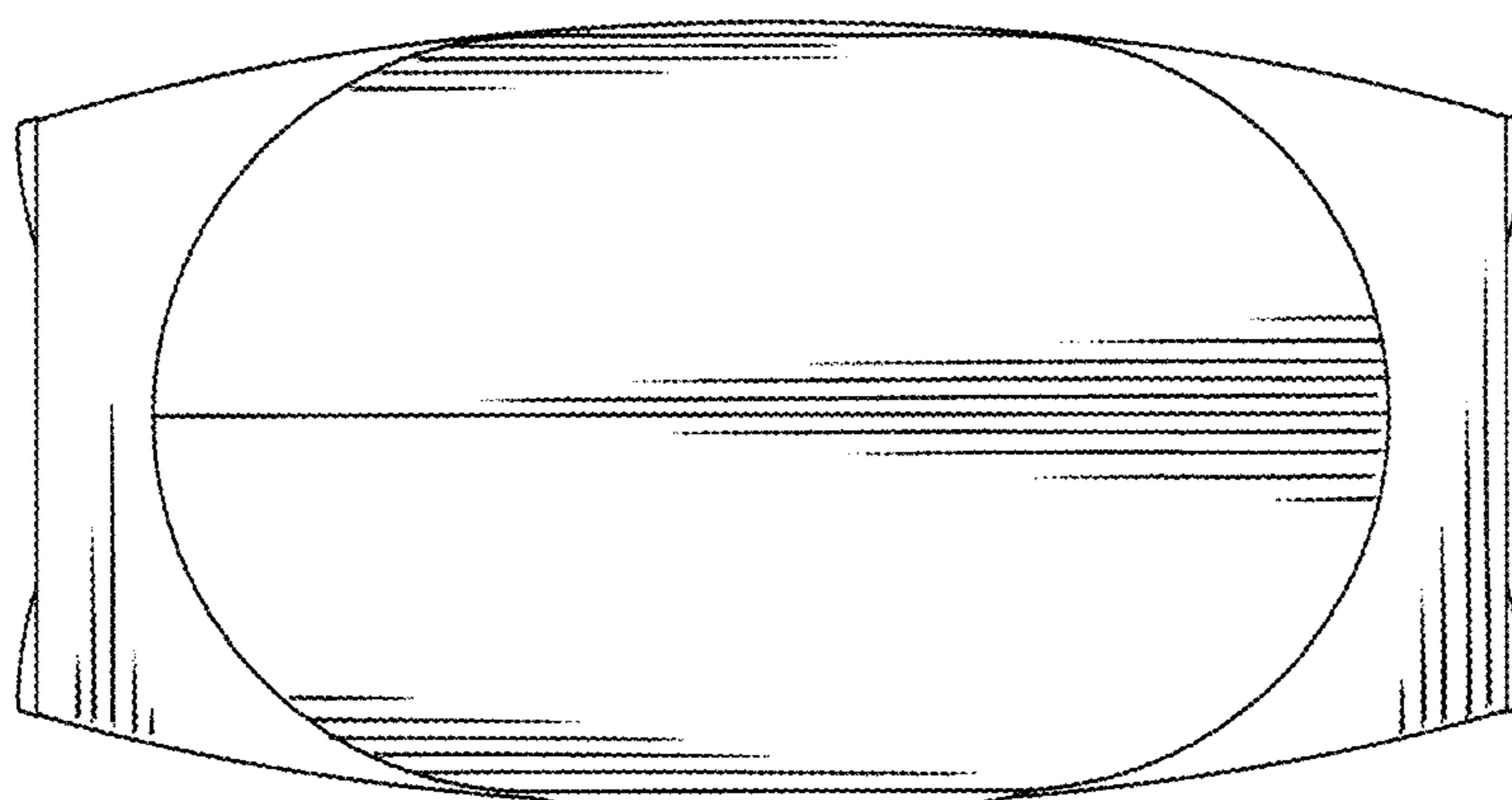

FIG. 7

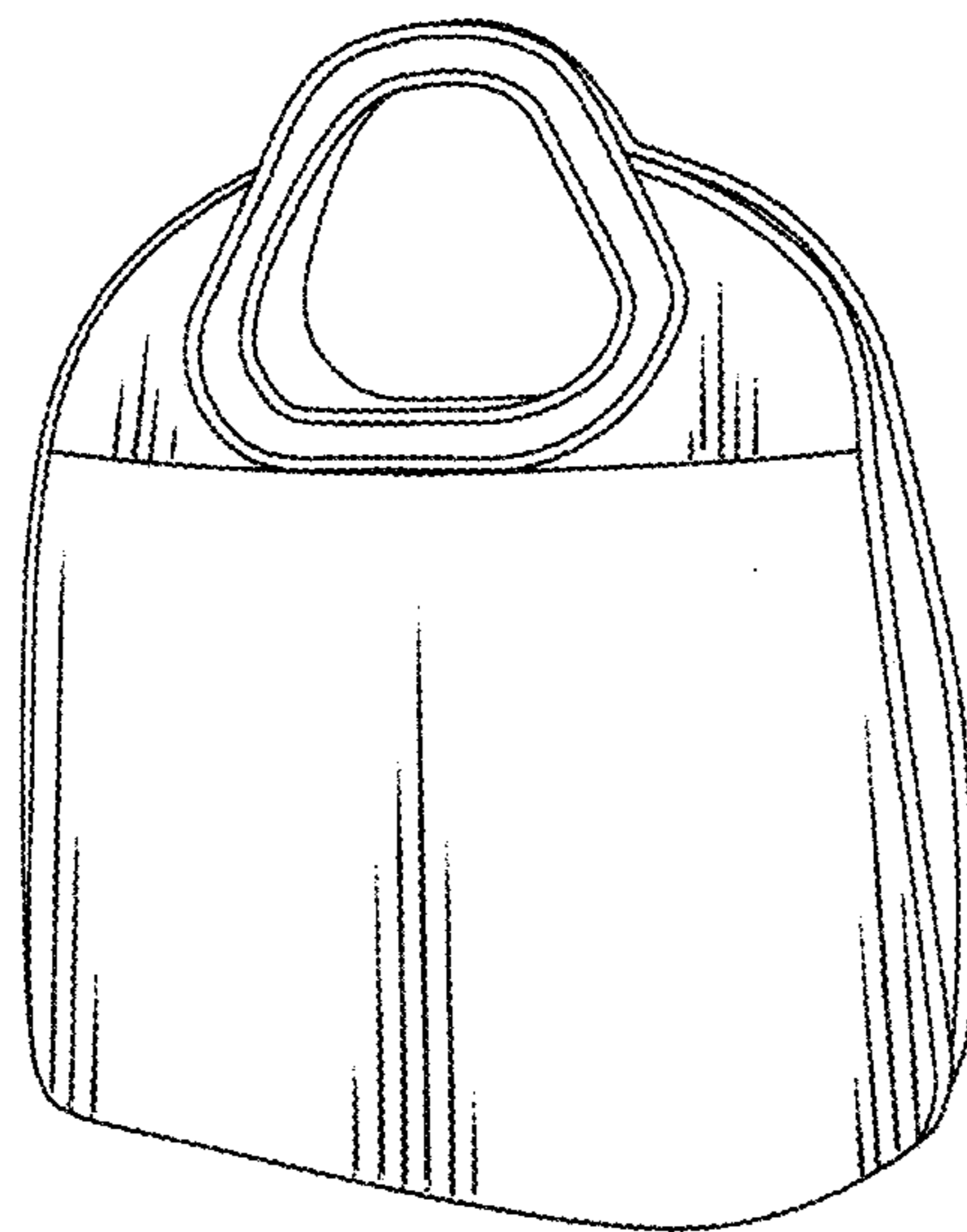

FIG. 8

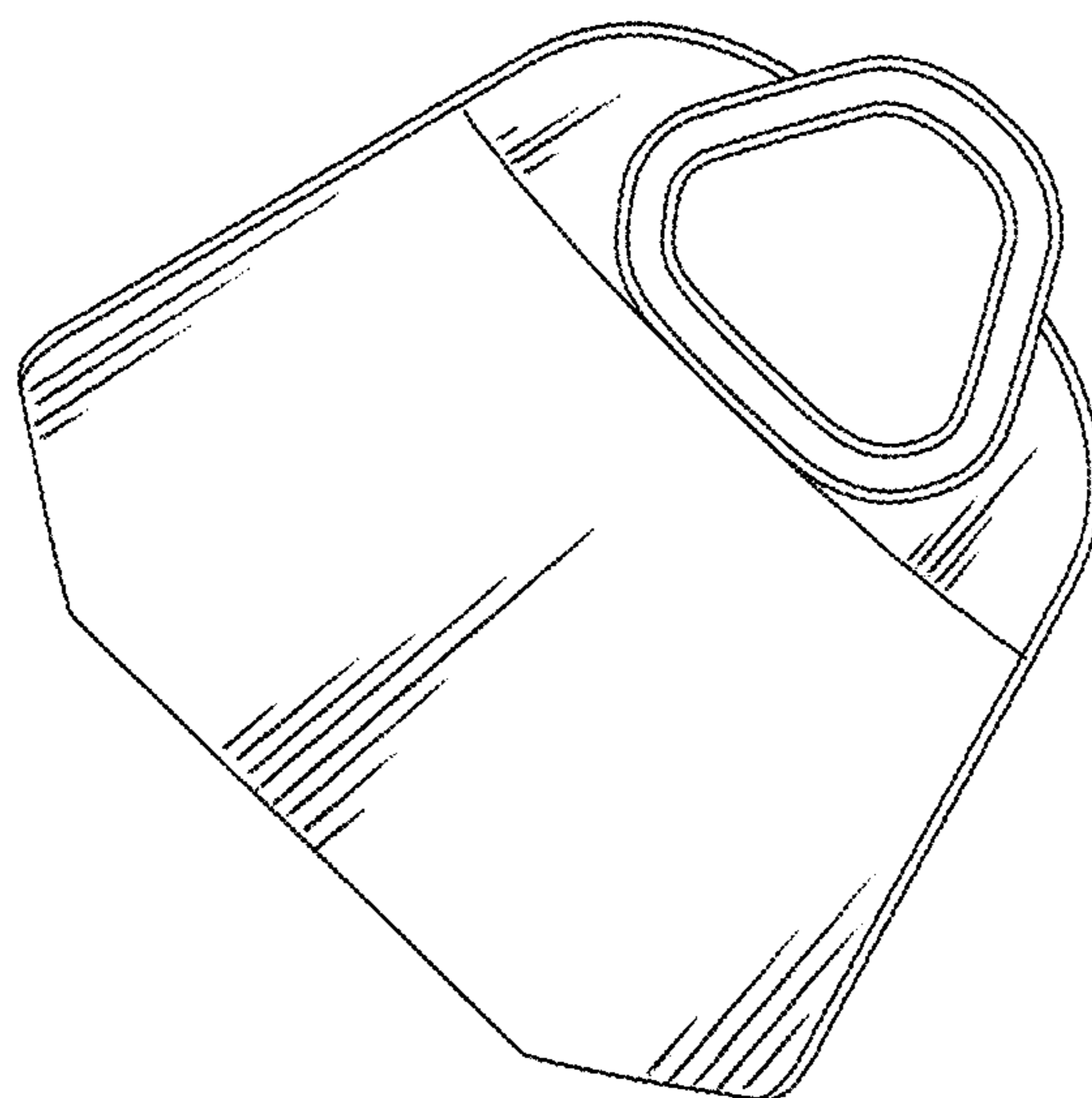

FIG. 9

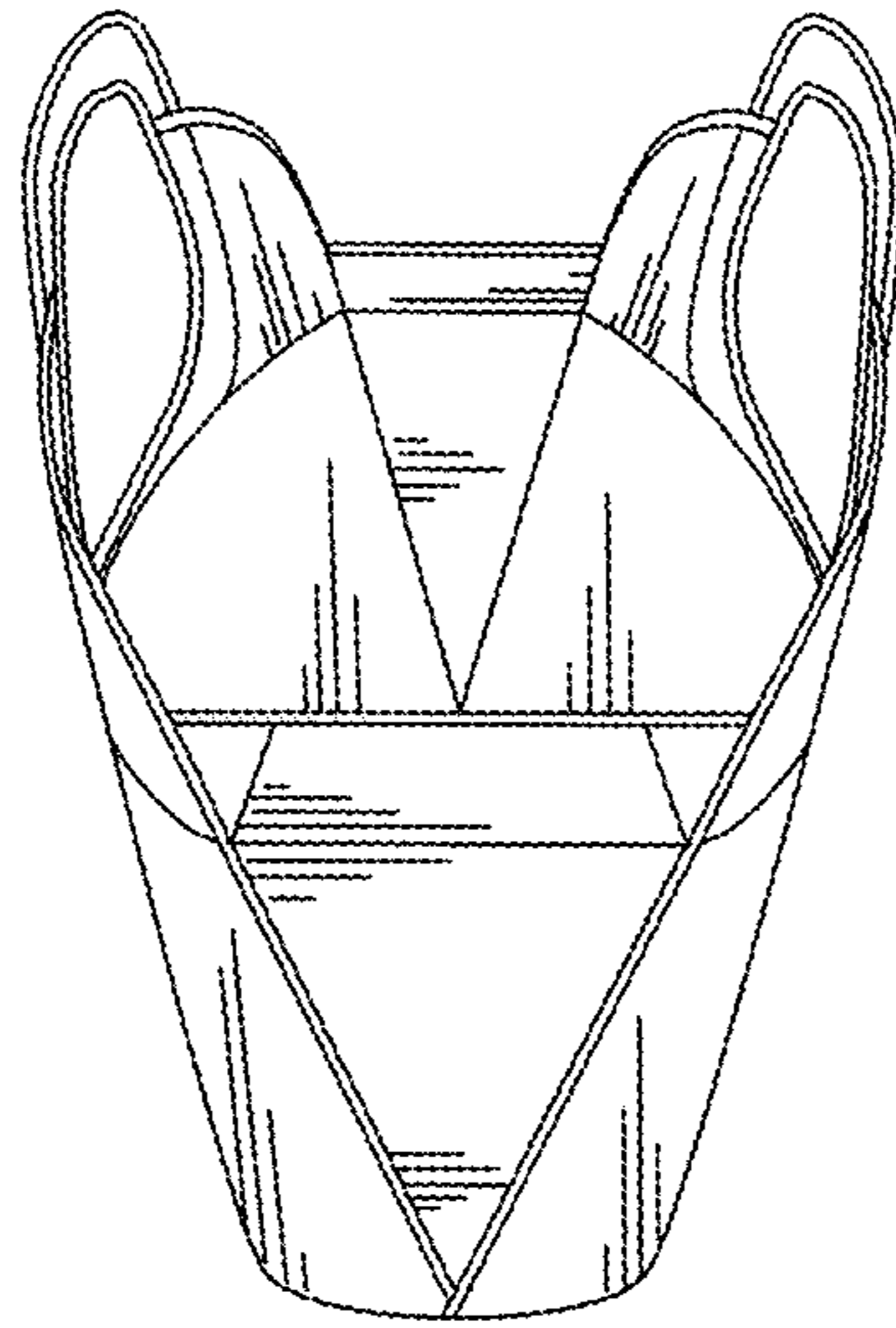

FIG. 10

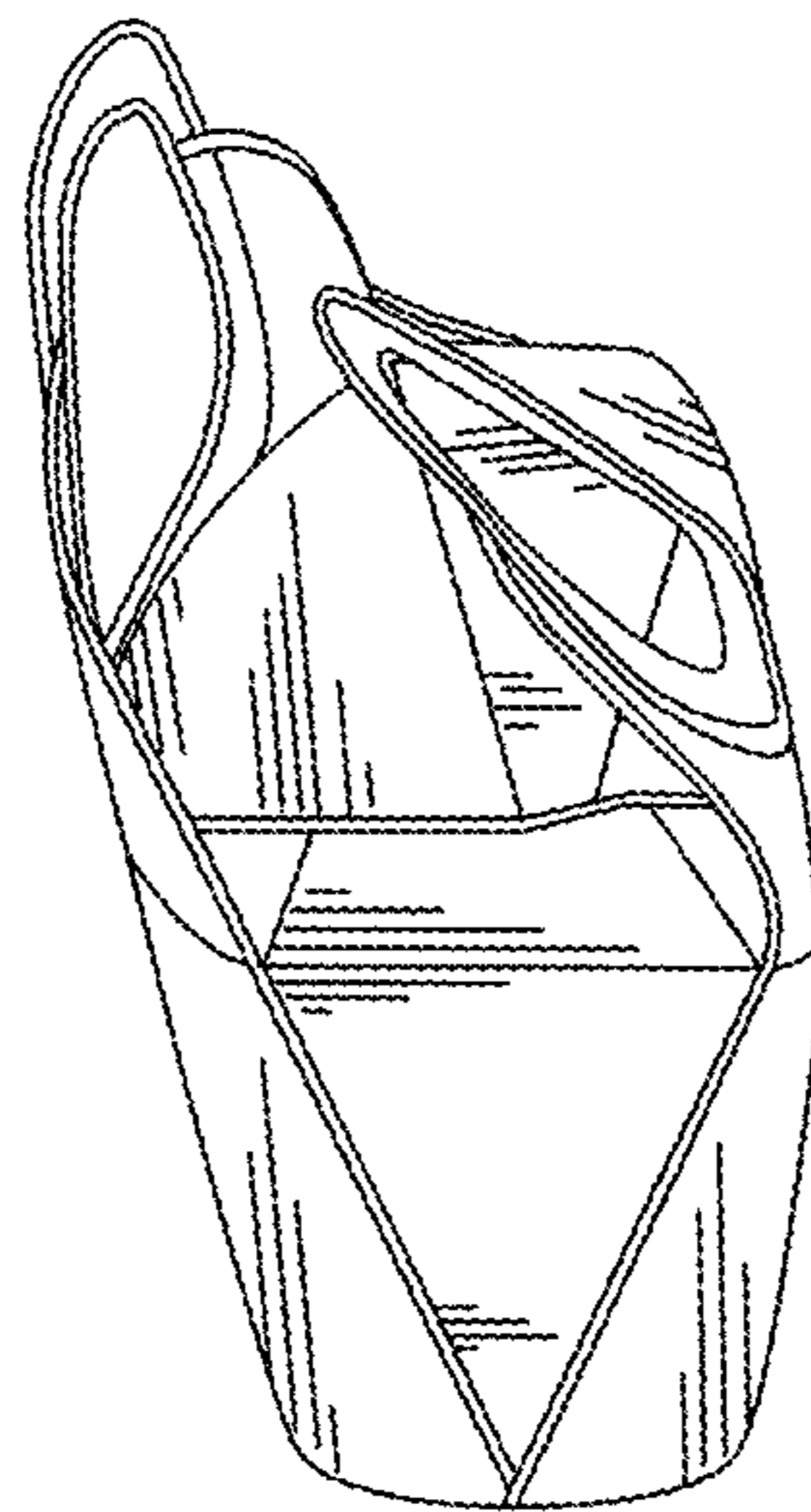

FIG. 11

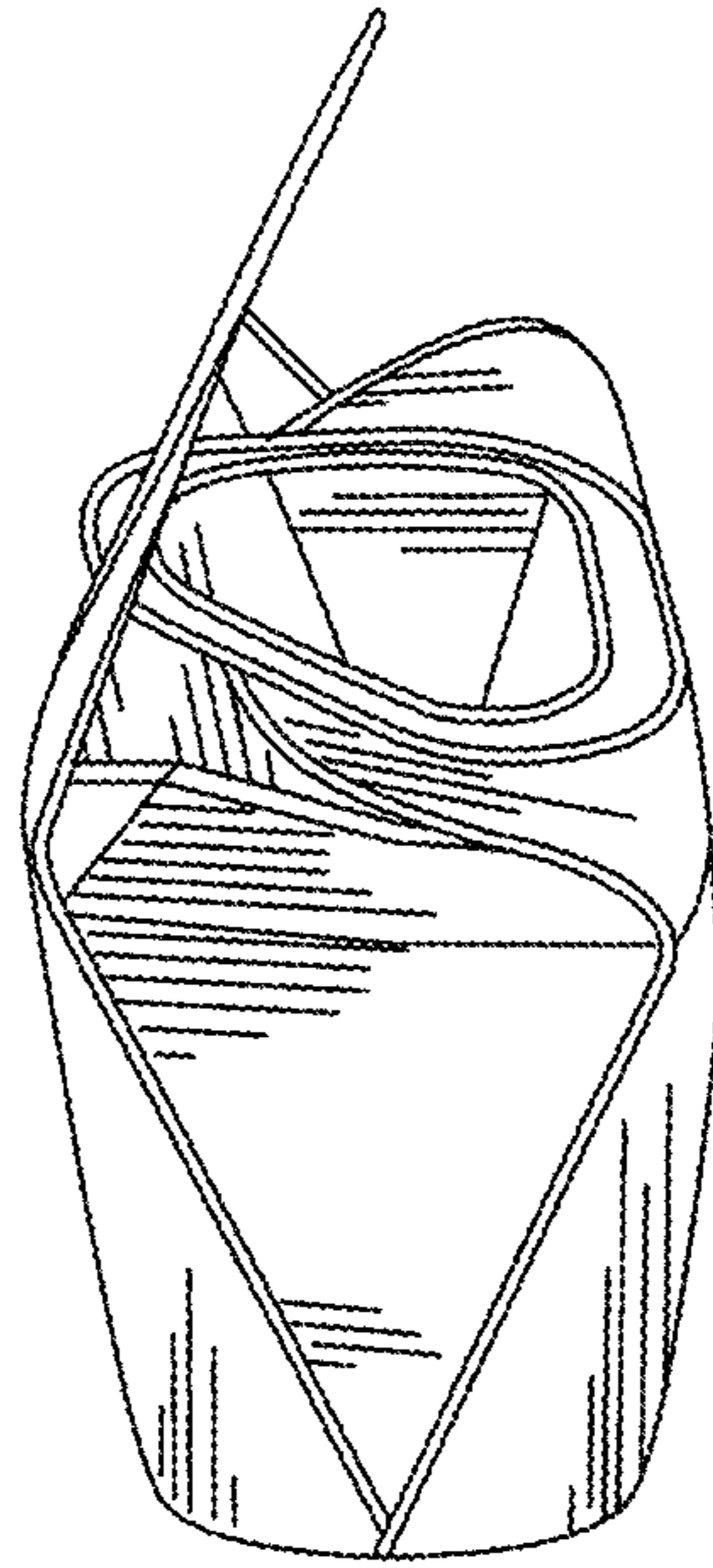

FIG. 12

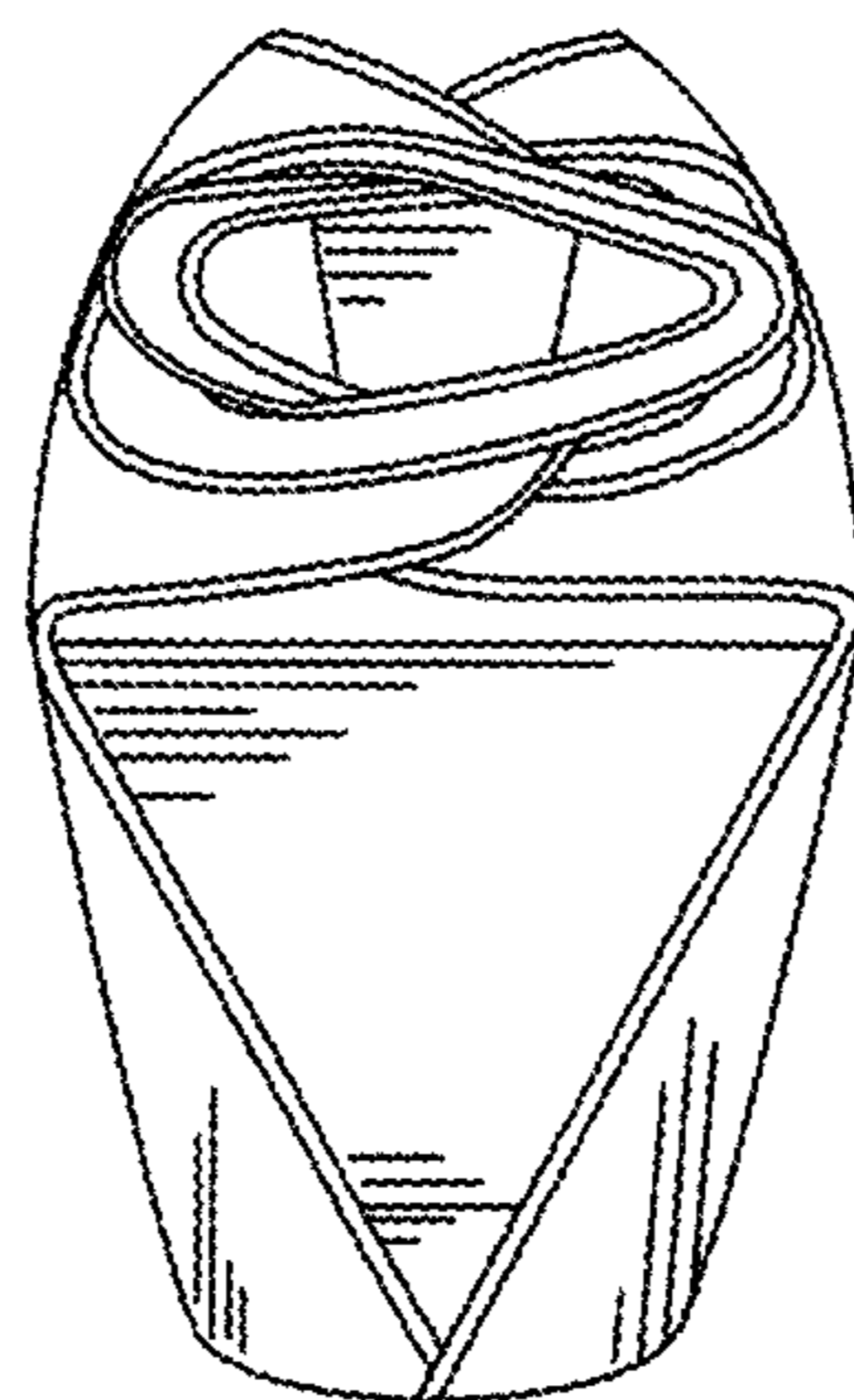

FIG. 13