



US00D802871S

(12) **United States Design Patent** (10) **Patent No.:** **US D802,871 S**  
**Knie** (45) **Date of Patent:** **\*\* Nov. 14, 2017**

(54) **BONNET FOR A VEHICLE**  
(71) Applicant: **Jungheinrich Aktiengesellschaft,**  
Hamburg (DE)  
(72) Inventor: **Andreas Knie,** Hamburg (DE)  
(73) Assignee: **Jungheinrich Aktiengesellschaft,**  
Hamburg (DE)  
(\*\*) Term: **15 Years**

D499,521 S *	12/2004	Swedish	.....	D34/35
D506,859 S *	6/2005	Ryan	.....	D34/35
D515,769 S *	2/2006	Ryan	.....	D34/35
D560,050 S *	1/2008	Tokach	.....	D15/31
D578,274 S *	10/2008	Tokach	.....	D15/31
D699,415 S *	2/2014	Kazaoka	.....	D34/35
D699,911 S *	2/2014	Kazaoka	.....	D34/35
D773,146 S *	11/2016	Sauvaget	.....	D34/34
D783,924 S *	4/2017	Sauvaget	.....	D34/35
D785,273 S *	4/2017	Sauvaget	.....	D34/35
D785,895 S *	5/2017	Molnar	.....	D34/35
D785,896 S *	5/2017	Molnar	.....	D34/35

\* cited by examiner

(21) Appl. No.: **29/566,019**  
(22) Filed: **May 26, 2016**

*Primary Examiner* — Mark Goodwin  
(74) *Attorney, Agent, or Firm* — Barclay Damon LLP

(30) **Foreign Application Priority Data**

Nov. 30, 2015 (EP) ..... 002883363

(51) **LOC (10) Cl.** ..... **12-05**  
(52) **U.S. Cl.**  
USPC ..... **D34/35; D15/31; D15/28**

(58) **Field of Classification Search**  
USPC ..... D15/22–28, 31, 33, 30; D34/34, 35;  
414/572, 592, 631, 785, 640, 601, 602,  
414/685, 687, 688, 694; 180/89.12,  
180/89.13, 89.17  
CPC ..... B66F 9/24; B66F 9/07563; B66F 9/105;  
B66F 9/07545; B66F 9/12; B66F 9/146;  
B66F 9/195; B66F 17/003  
See application file for complete search history.

(56) **References Cited**

**U.S. PATENT DOCUMENTS**

D499,519 S *	12/2004	Swedish	.....	D34/34
D499,520 S *	12/2004	Swedish	.....	D34/35

(57) **CLAIM**

The ornamental design for a bonnet for a vehicle, as shown and described.

**DESCRIPTION**

FIG. 1 is a front left perspective view of a bonnet for a vehicle;  
FIG. 2 is a front left perspective view thereof;  
FIG. 3 is a rear elevational view thereof;  
FIG. 4 is a right side elevational view thereof, the left side elevational view being a mirror image;  
FIG. 5 is top plan view thereof;  
FIG. 6 is a bottom plan view thereof; and,  
FIG. 7 is a front elevational view.  
Broken lines are shown herein for illustrative purposes only, and form no part of the claimed design.

**1 Claim, 7 Drawing Sheets**

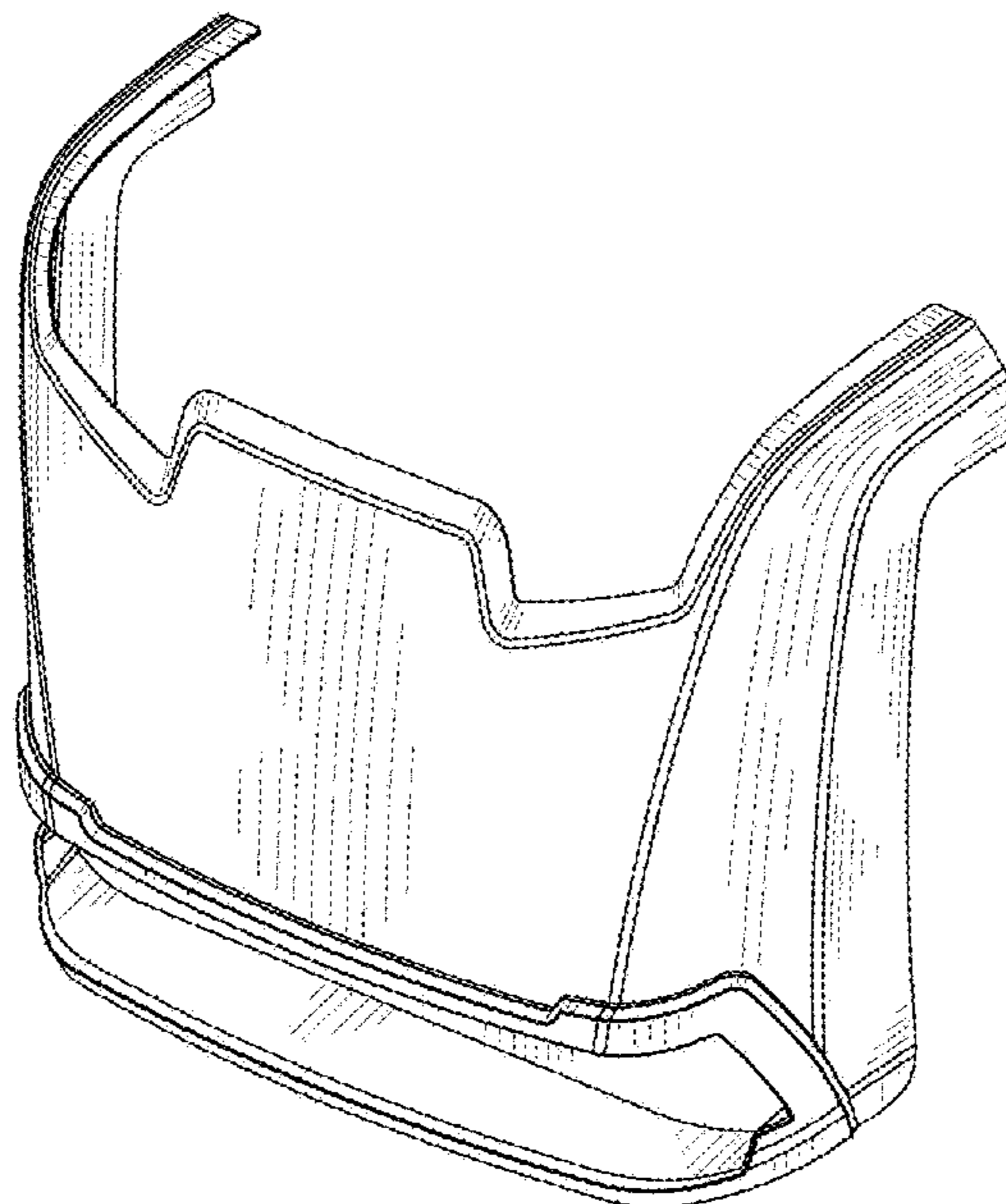

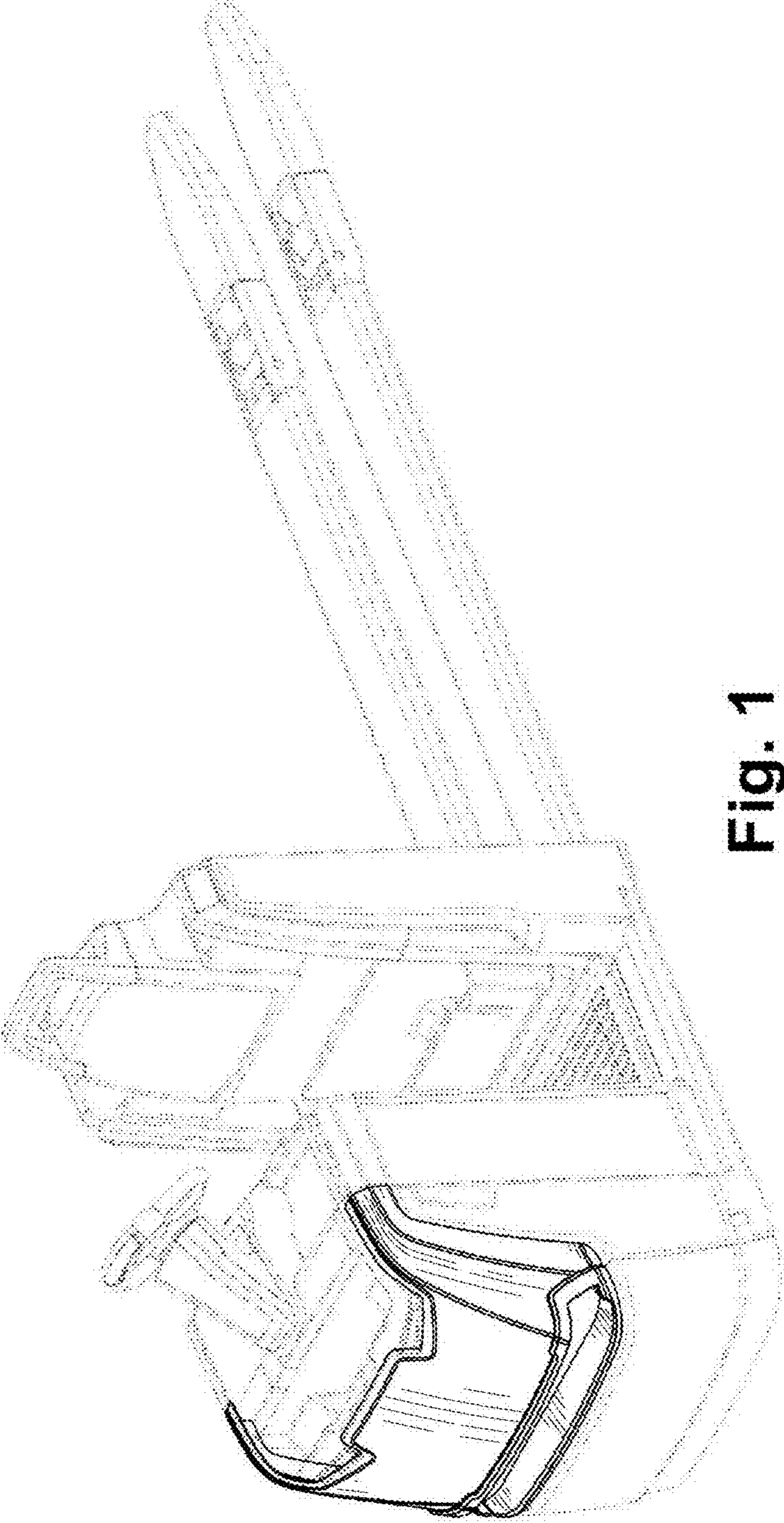

Fig. 1

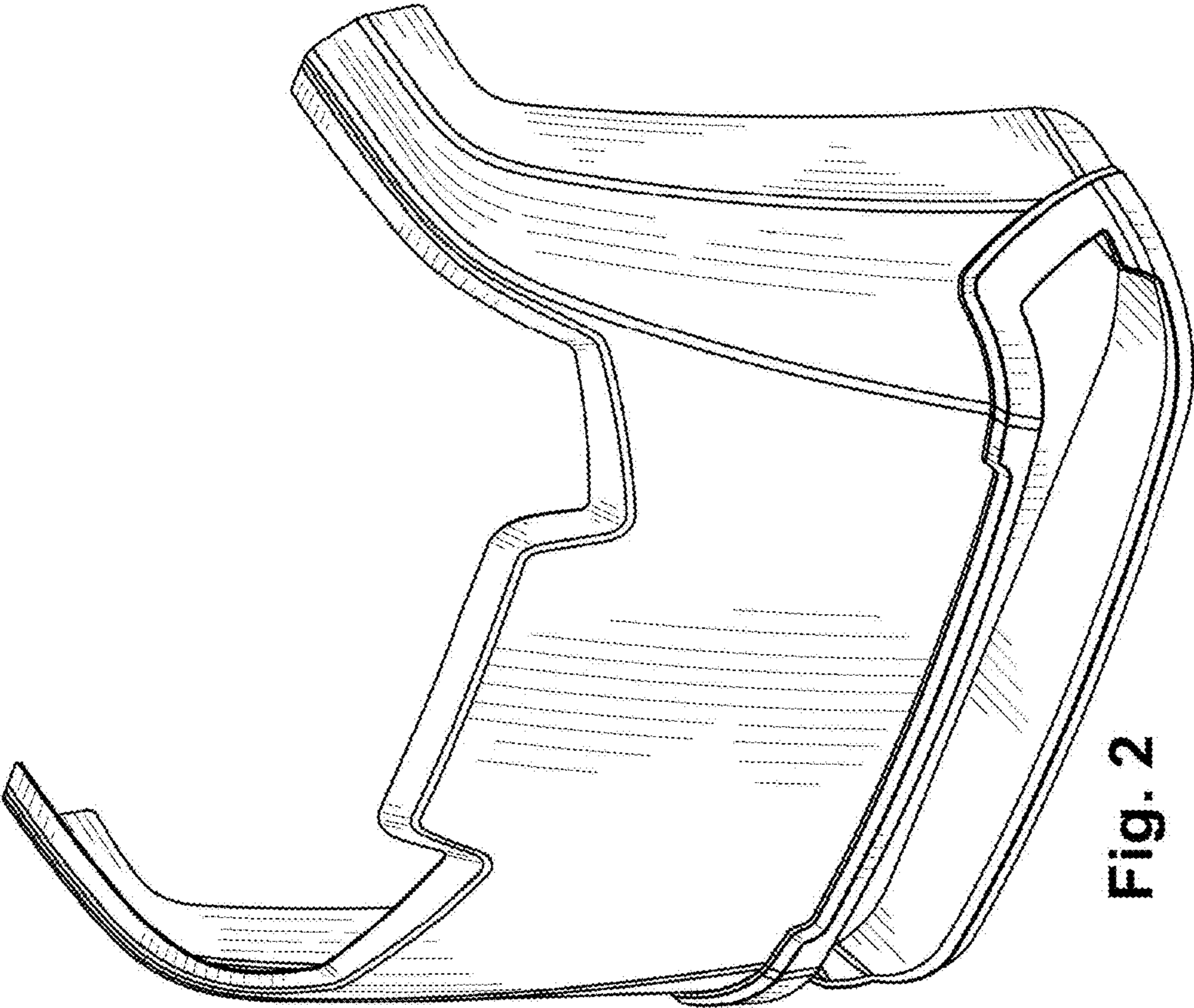

Fig. 2



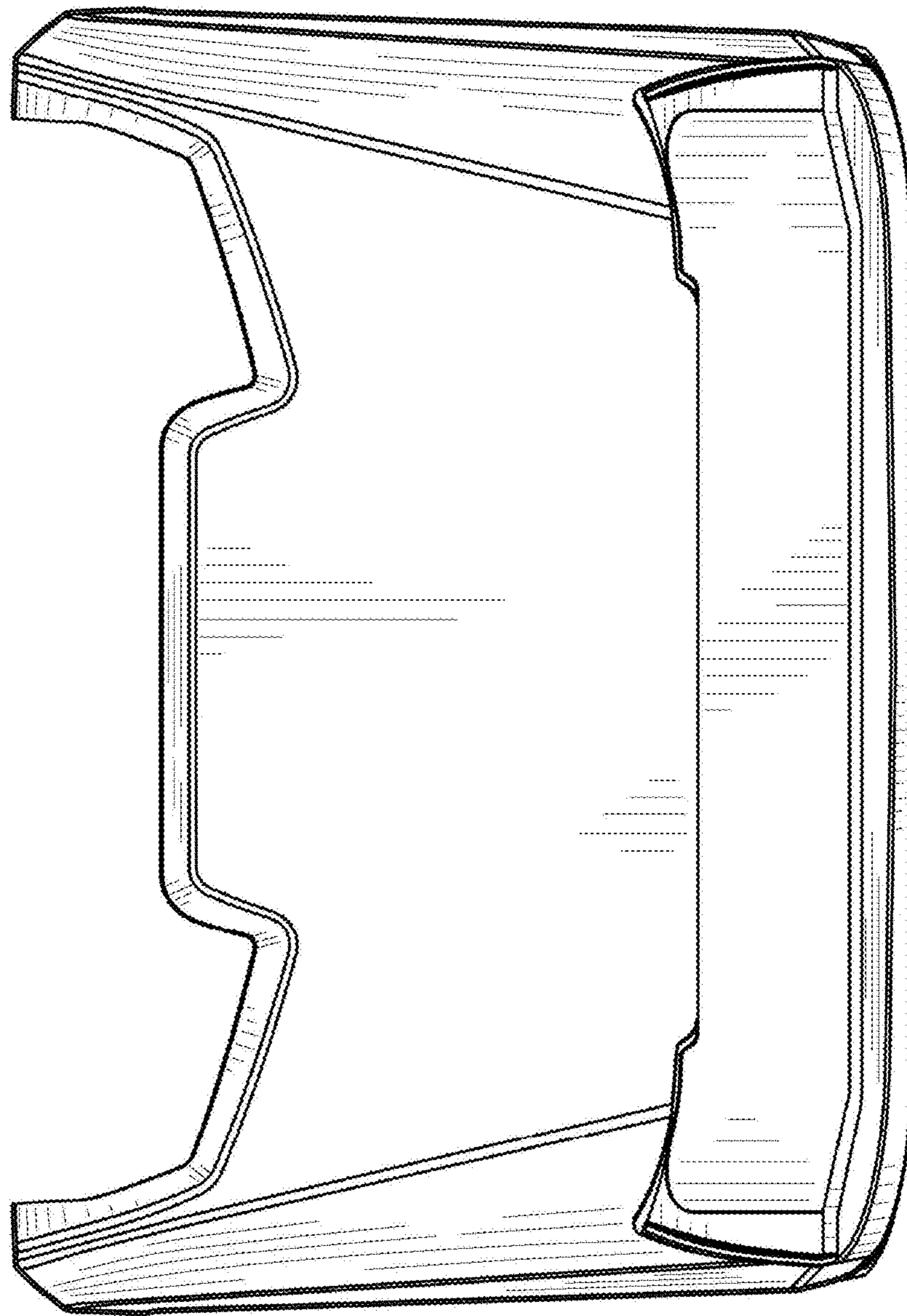

Fig. 3

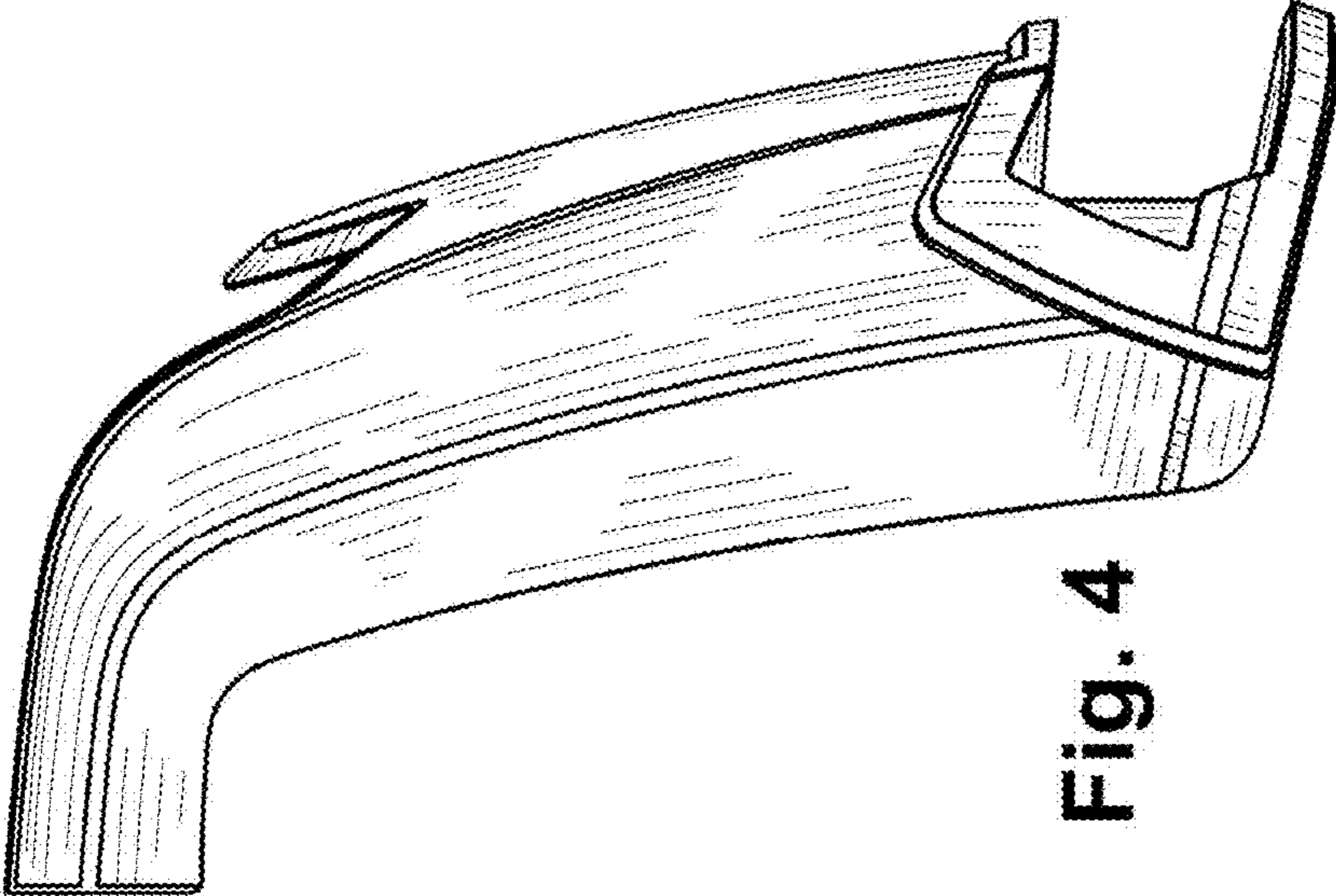

Fig. 4

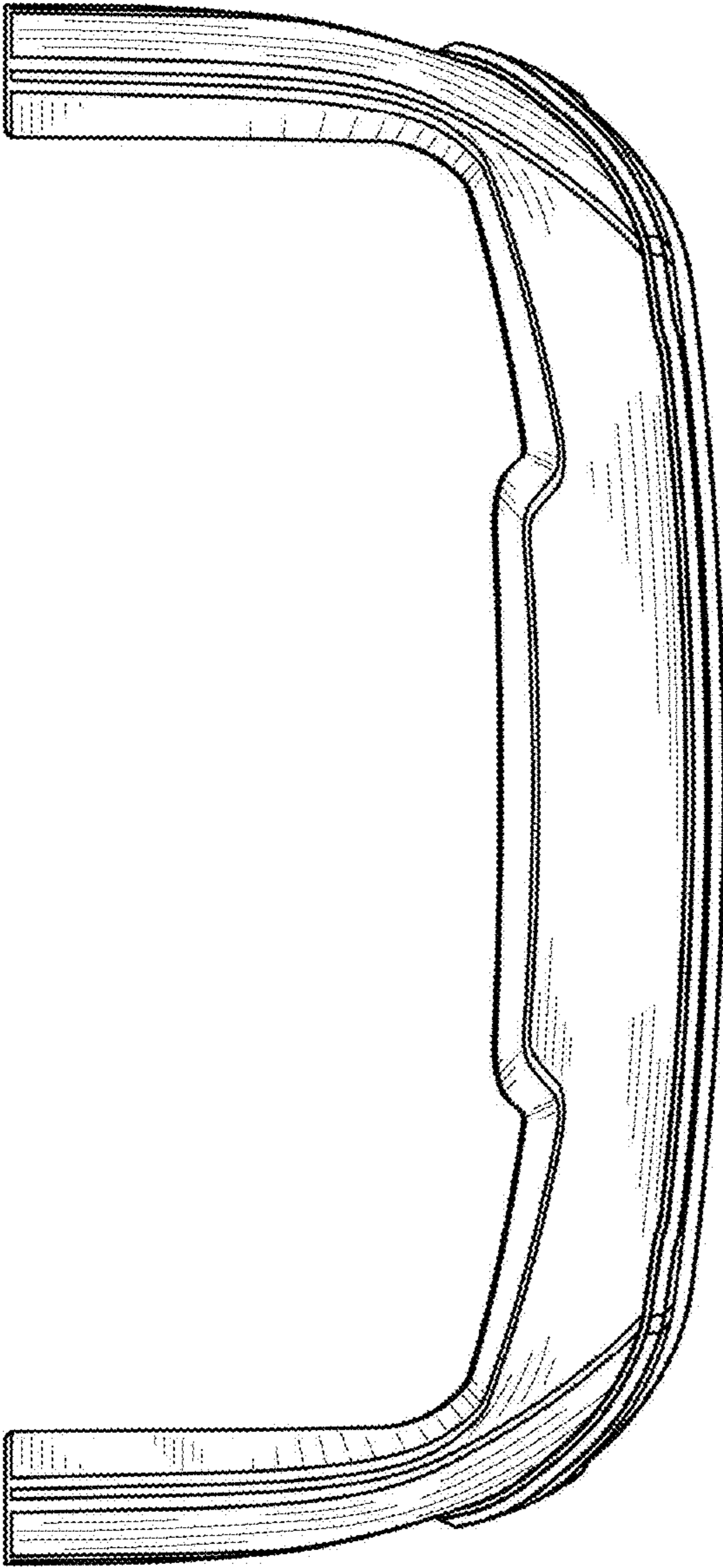

Fig. 5

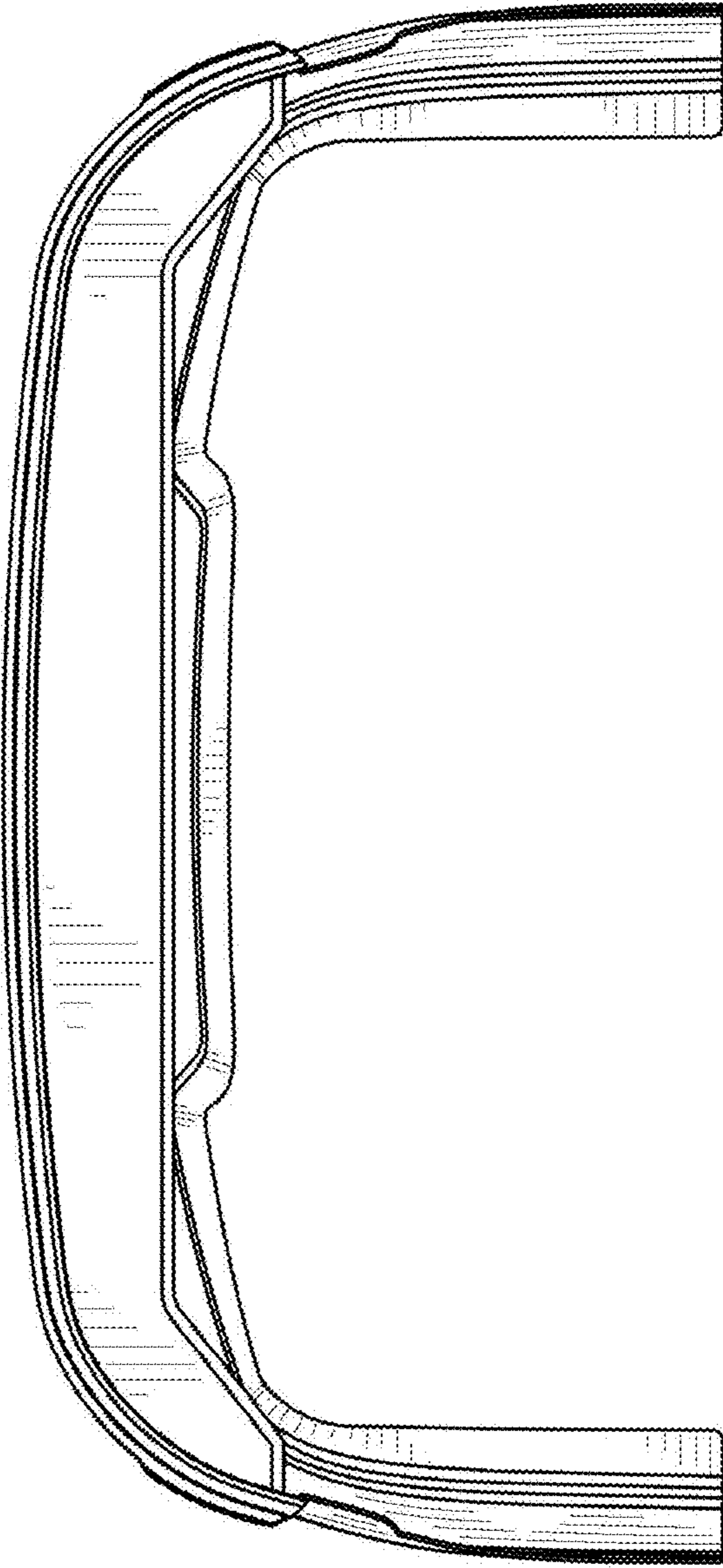

Fig. 6

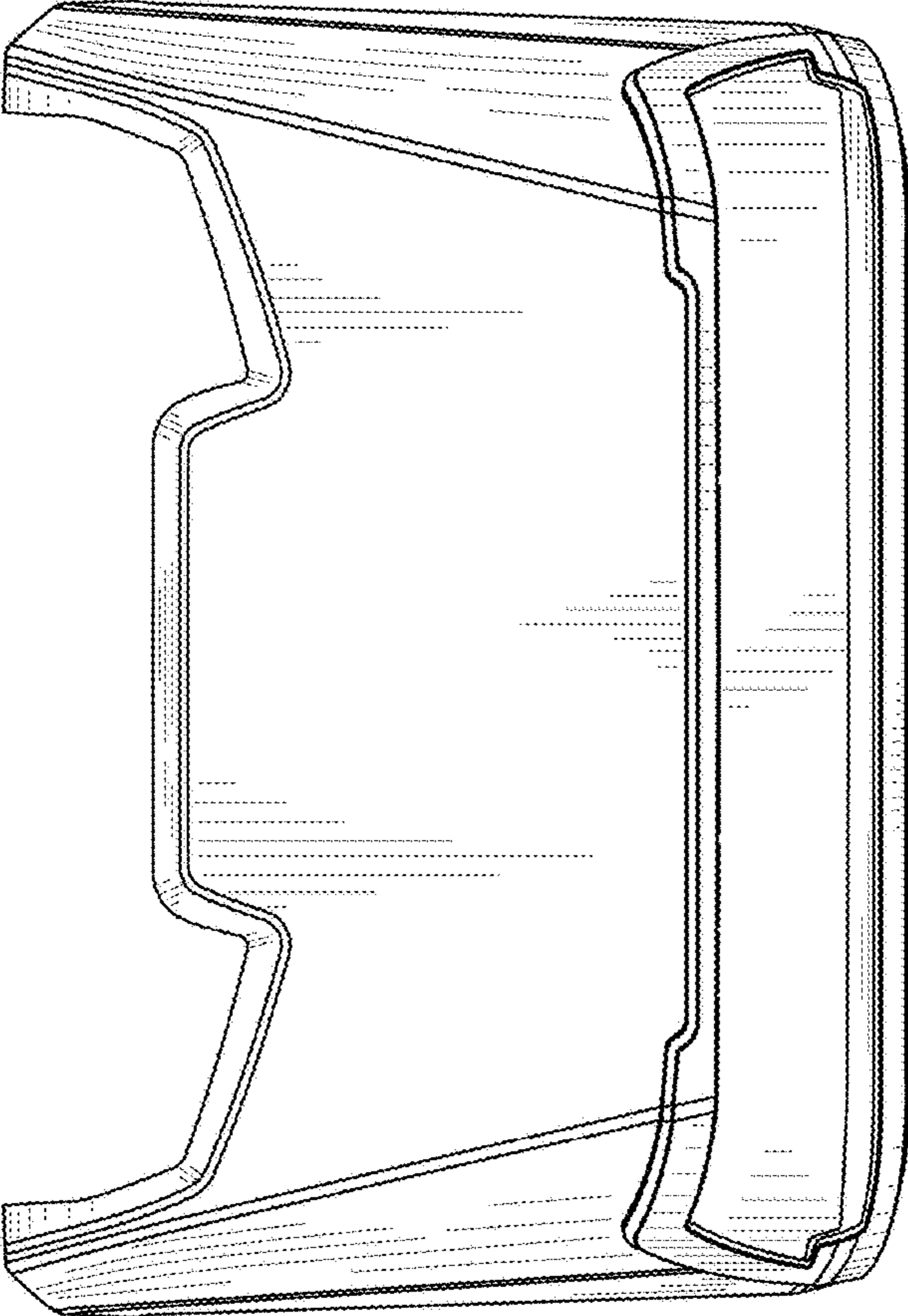

Fig. 7