



US00D802841S

(12) **United States Design Patent** (10) **Patent No.:** **US D802,841 S**
Kling et al. (45) **Date of Patent:** **** Nov. 14, 2017**

(54) **HAIR REMOVING APPLIANCE**
(71) Applicant: **Braun GmbH**, Kronberg (DE)
(72) Inventors: **Björn Kling**, Glashutten (DE);
Christoph Ptok, Frankfurt (DE)
(73) Assignee: **Braun GmbH**, Kronberg (DE)
(**) Term: **15 Years**
(21) Appl. No.: **29/586,204**
(22) Filed: **Dec. 1, 2016**

D589,650 S 3/2009 Adriaenssen
D621,949 S 8/2010 Seki et al.
D664,295 S 7/2012 Grabes et al.
D685,523 S 7/2013 Buogo et al.
D696,778 S 12/2013 Liao et al.
D705,484 S 5/2014 Bourgeois
D706,980 S 6/2014 Tasar et al.
D707,839 S 6/2014 Bradley et al.
D776,873 S * 1/2017 Levi D28/44.1
D776,874 S * 1/2017 Kling D28/44.1
D789,604 S * 6/2017 Levi D28/44.1
2010/0063565 A1 3/2010 Beerwerth et al.
2011/0270365 A1 11/2011 Hamada et al.
2012/0232539 A1 9/2012 Liu et al.
2015/0209108 A1 7/2015 Kim

* cited by examiner

Related U.S. Application Data

(62) Division of application No. 29/528,894, filed on Jun. 2, 2015, now Pat. No. Des. 776,874.
(51) **LOC (10) Cl.** **28-03**
(52) **U.S. Cl.**
USPC **D28/44.1**; D24/133; D24/209
(58) **Field of Classification Search**
USPC D28/44, 44.1, 49-54; D24/133, 209
CPC .. A61B 2018/00476; A61B 2018/0047; A61B
2018/202; A61B 2018/203; A45D 26/00;
A45D 26/0004
See application file for complete search history.

Primary Examiner — Jennifer Rivard

(74) *Attorney, Agent, or Firm* — Ronald T. Sia; Kevin C. Johnson; Steven W. Miller

(57) **CLAIM**

The ornamental design for a hair removing appliance, as shown and described.

DESCRIPTION

FIG. 1 is a perspective view of a hair removing appliance; FIG. 2 is a front view thereof; FIG. 3 is a right side view thereof; FIG. 4 is a rear view thereof; FIG. 5 is a left side view thereof; FIG. 6 is a top plan view thereof; and, FIG. 7 is a bottom plan view thereof.

(56) **References Cited**

U.S. PATENT DOCUMENTS

D535,746 S 1/2007 Grove et al.
D571,040 S 6/2008 Seki et al.

1 Claim, 6 Drawing Sheets

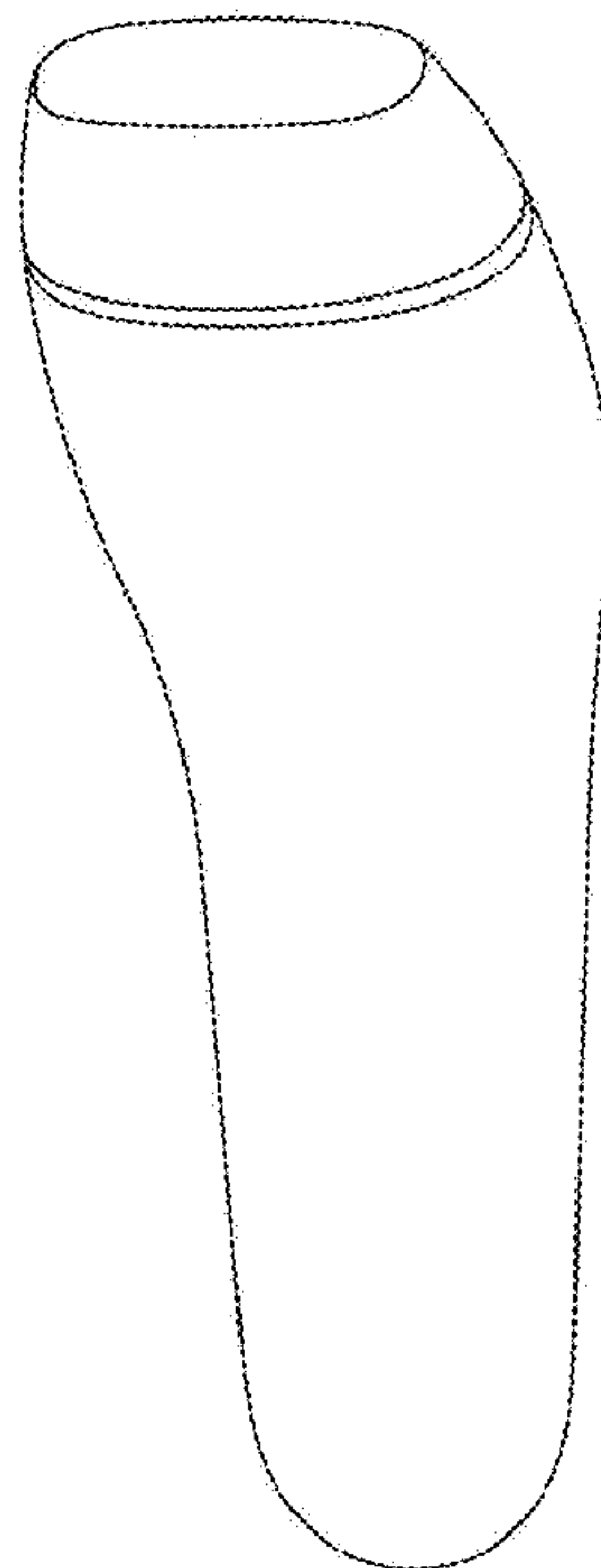

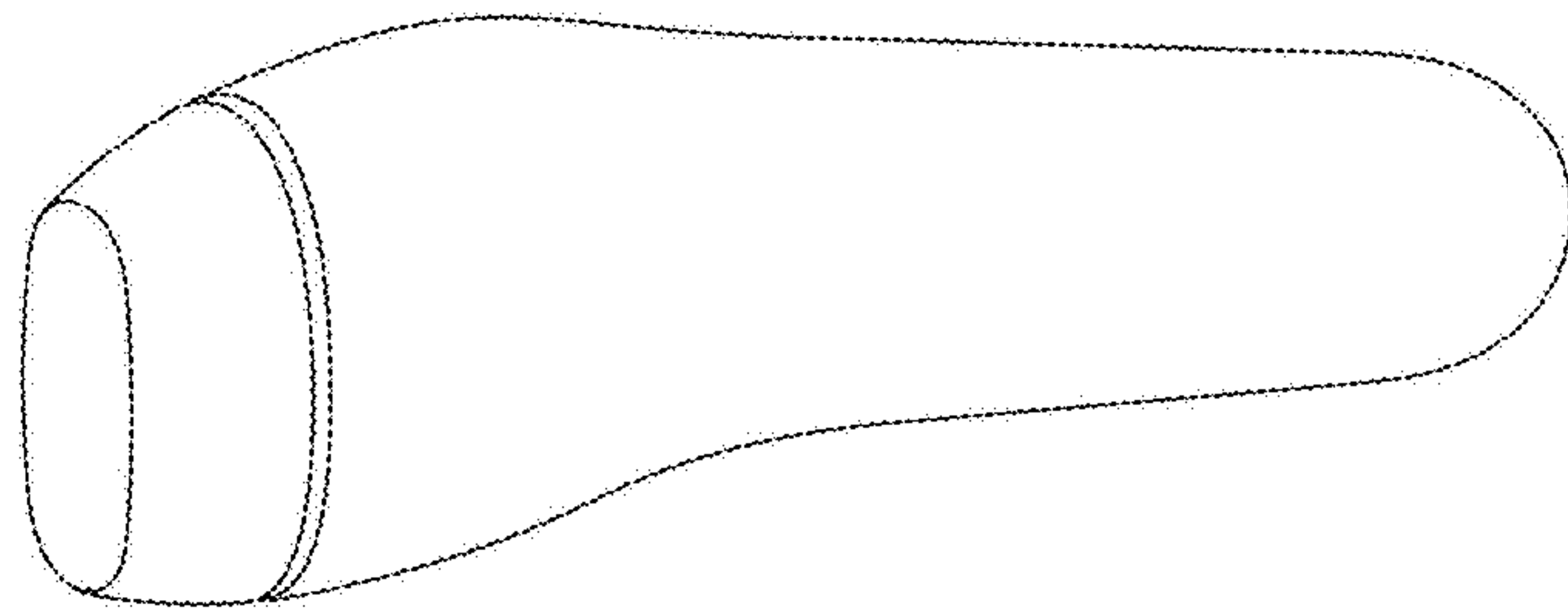

FIG. 1

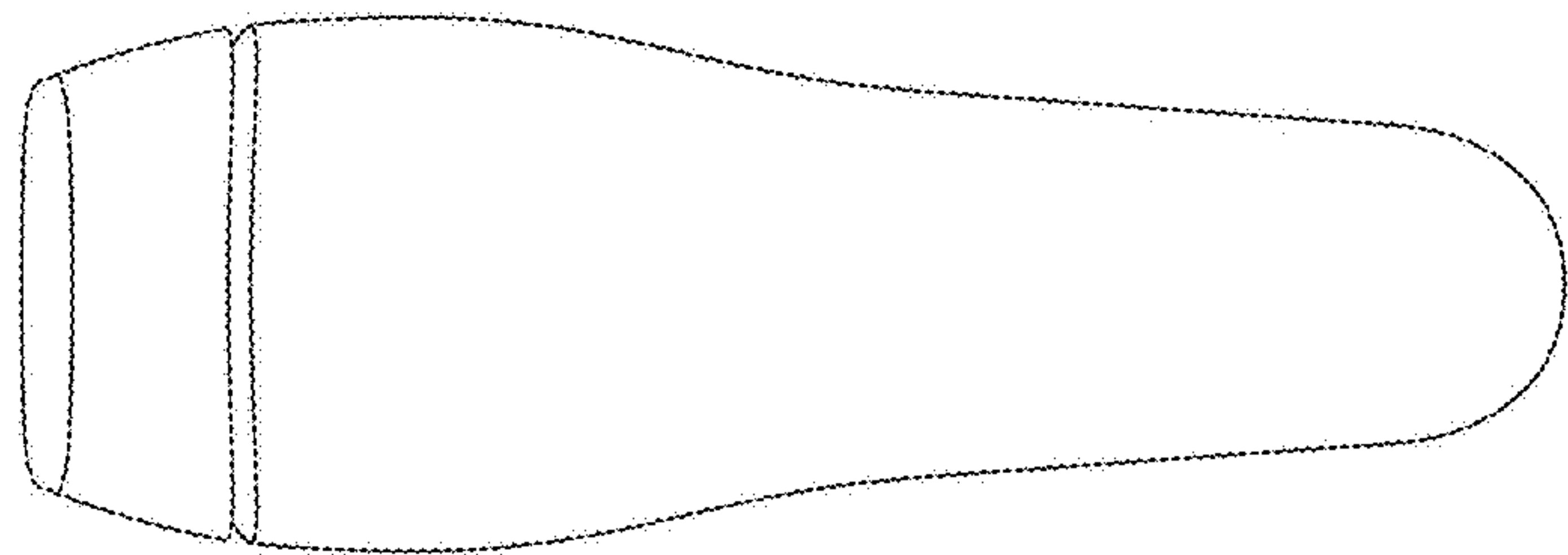

FIG. 2

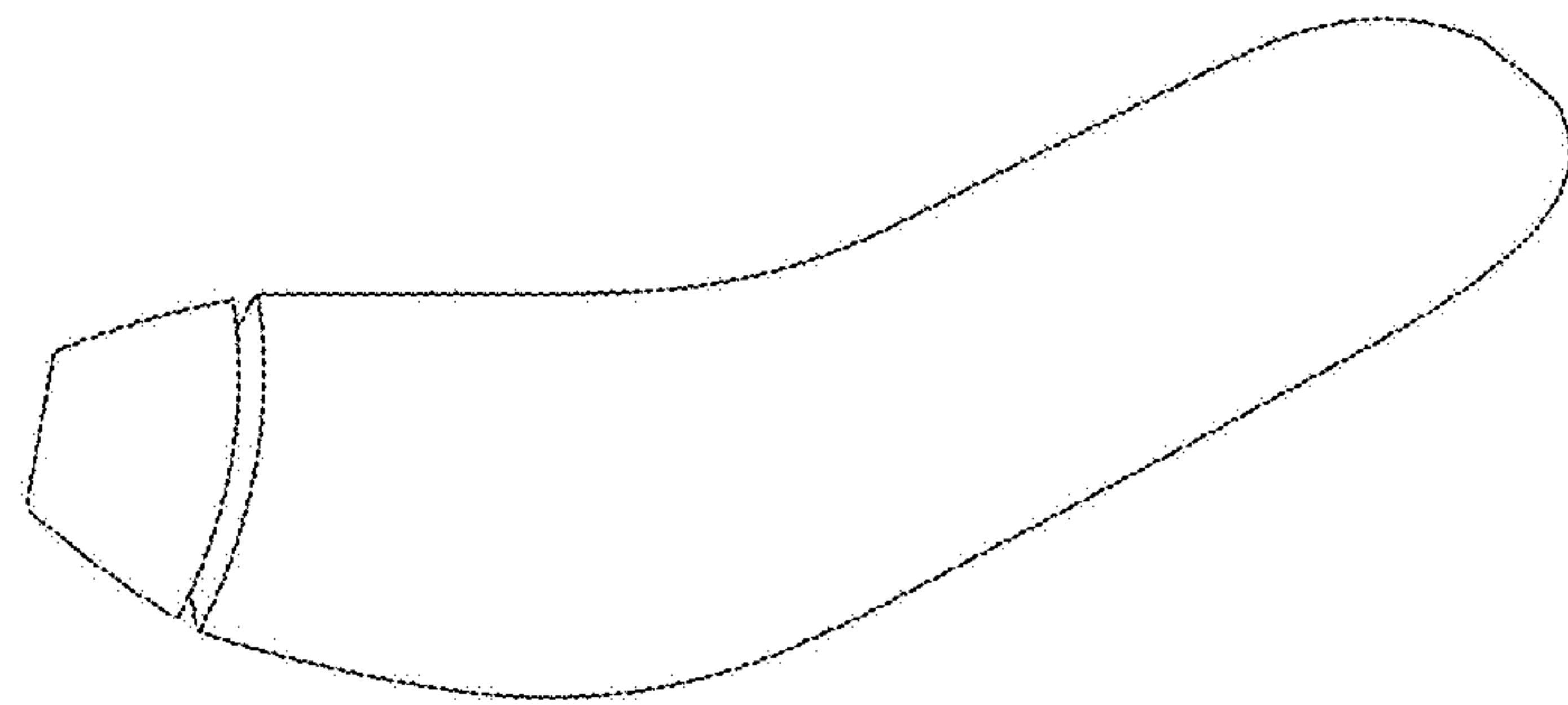

FIG. 3

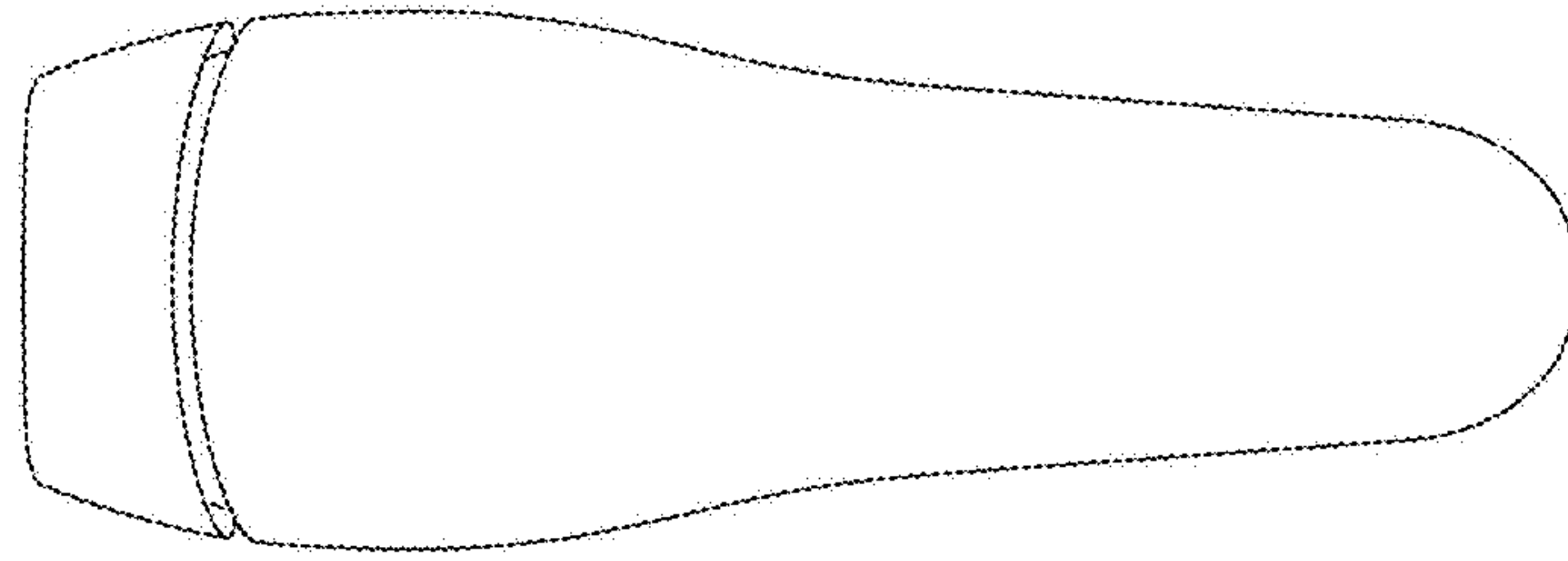

FIG. 4

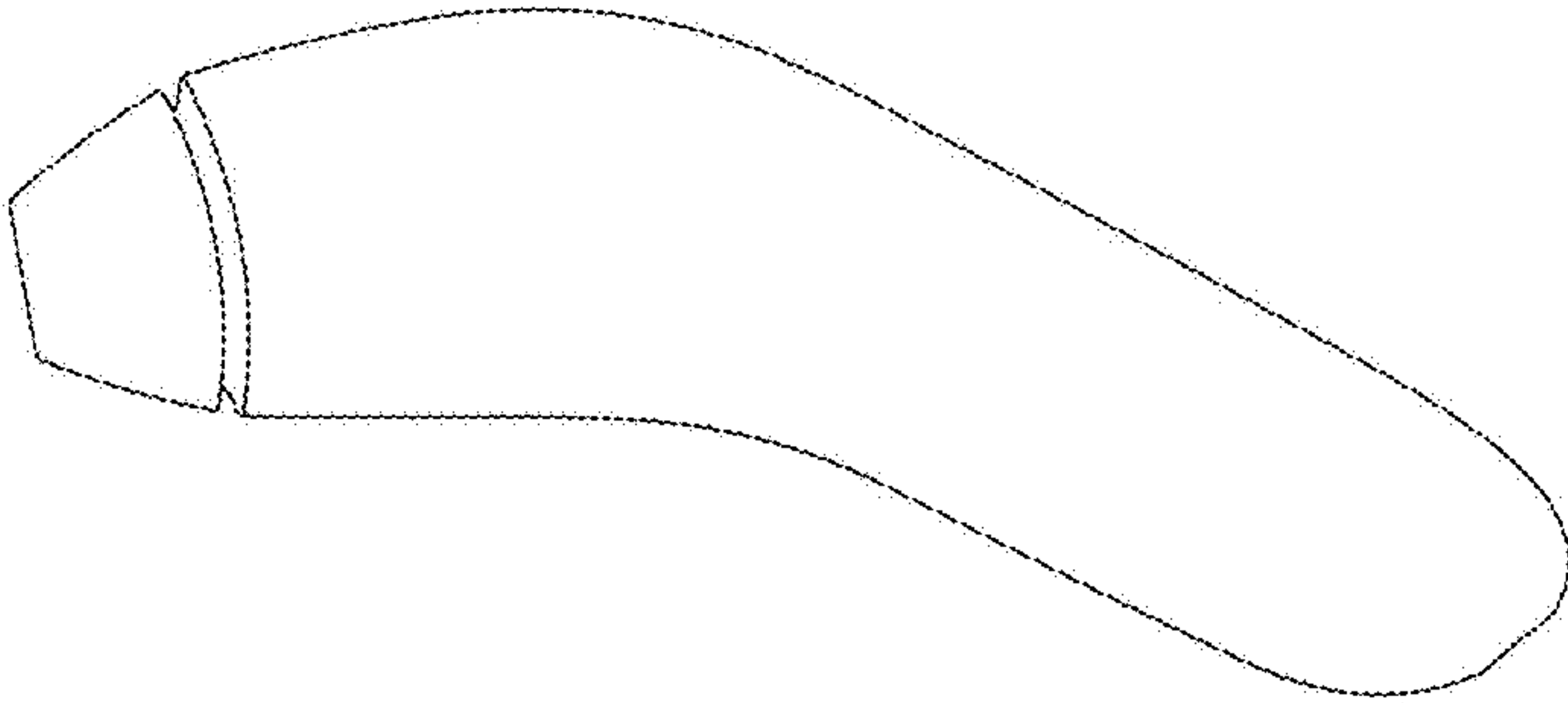

FIG. 5

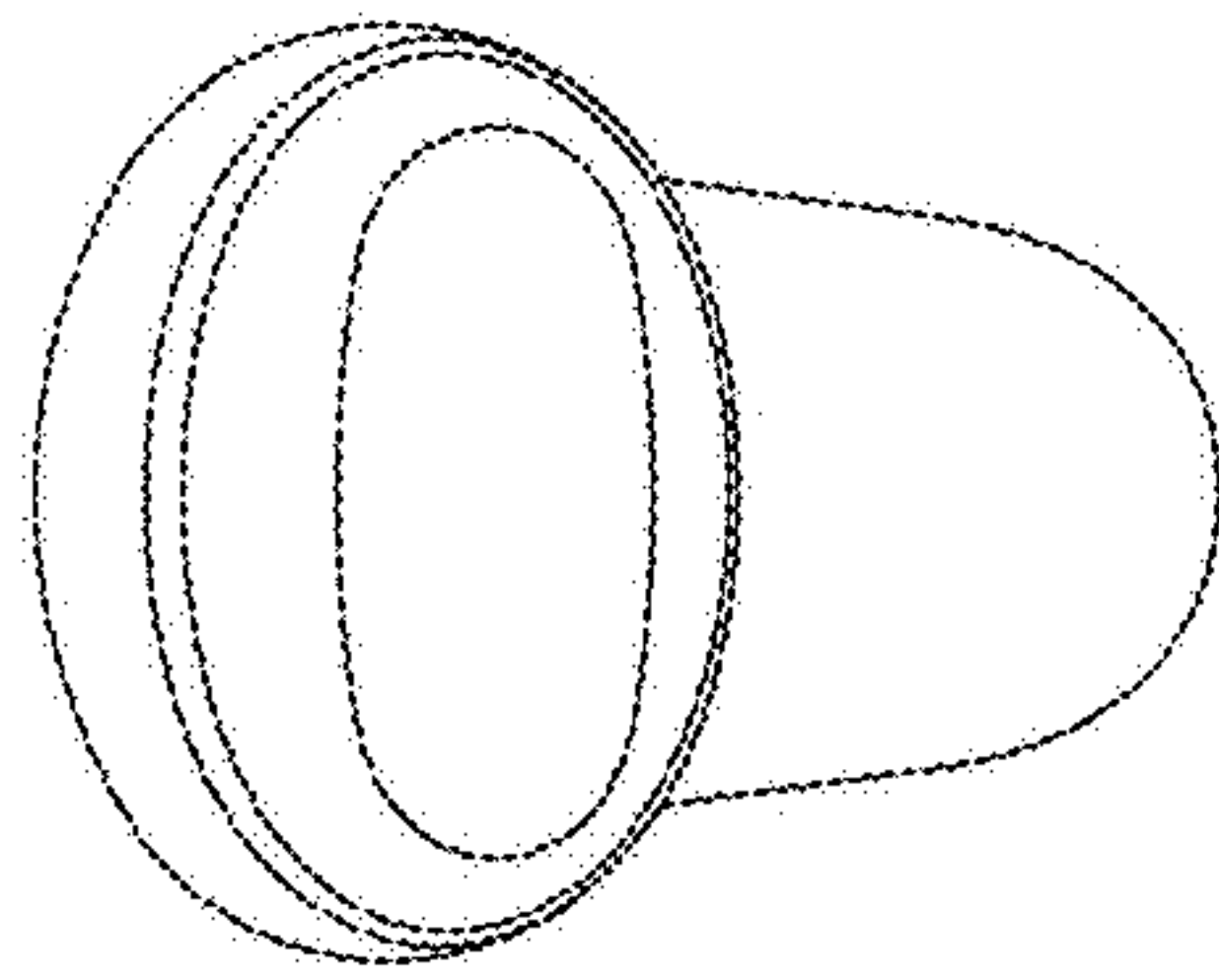

FIG. 6

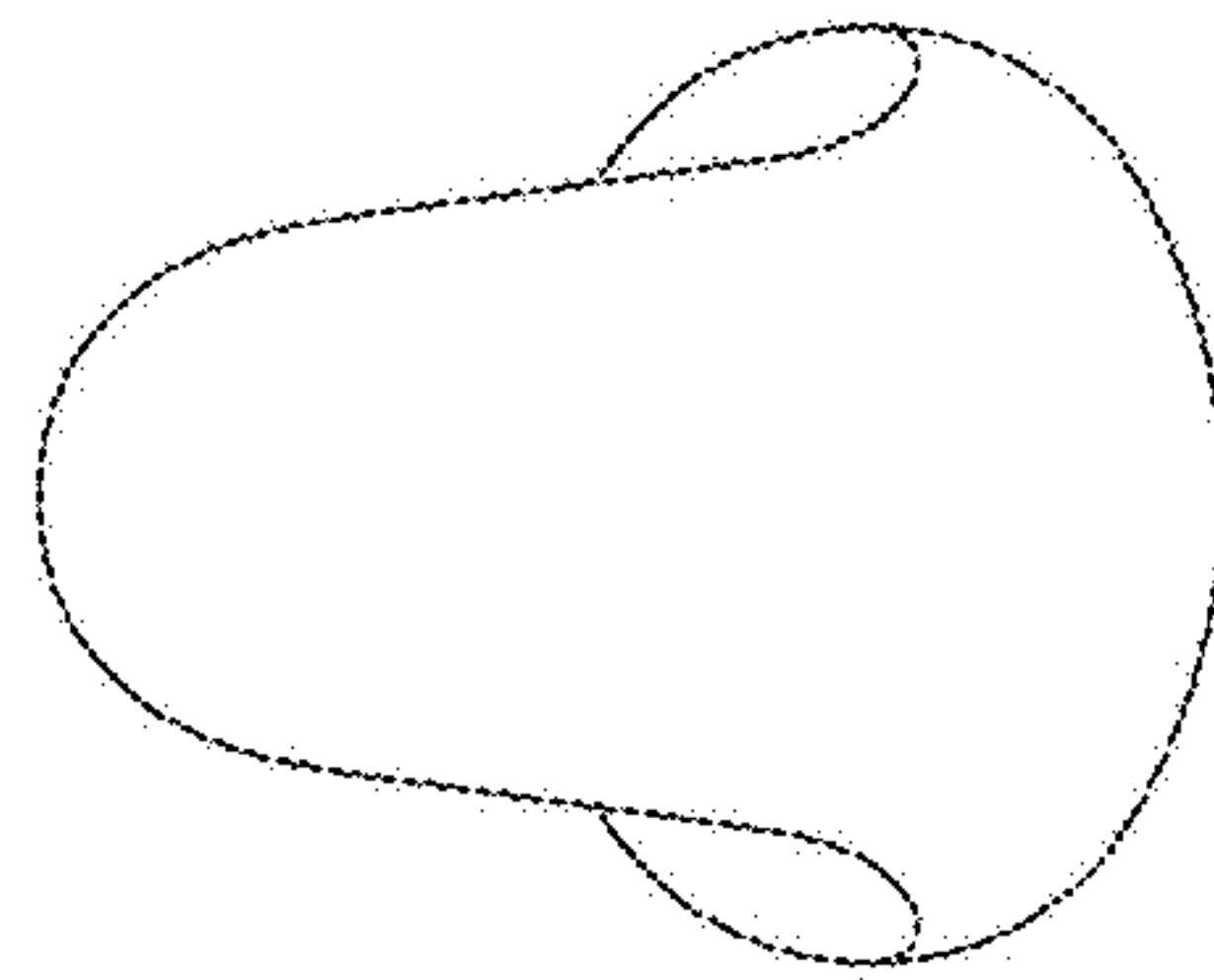

FIG. 7