

US00D802829S

(12) **United States Design Patent**
Reynolds

(10) **Patent No.:** **US D802,829 S**
(45) **Date of Patent:** **** Nov. 14, 2017**

(54) **HORTICULTURE GROW LIGHT**

- (71) Applicant: **IP Holdings, LLC**, Vancouver, WA (US)
- (72) Inventor: **Christopher Reynolds**, Vancouver, WA (US)
- (73) Assignee: **IP Holdings, LLC**, Vancouver, WA (US)
- (**) Term: **15 Years**
- (21) Appl. No.: **29/593,778**
- (22) Filed: **Feb. 13, 2017**

Related U.S. Application Data

- (63) Continuation of application No. 29/572,282, filed on Jul. 26, 2016, now Pat. No. Des. 781,492, which is a (Continued)

- (51) **LOC (10) Cl.** **29-99**
- (52) **U.S. Cl.**
USPC **D26/118**

- (58) **Field of Classification Search**
USPC ... D26/9, 10, 12, 13, 15, 16, 24, 51, 61, 72, D26/76, 80, 81, 85, 86, 88, 90, 113, 118, D26/119, 120, 122, 128, 129, 138, 143, D26/144
CPC B60Q 1/04; B60Q 1/26; F21S 8/026; F21S 8/04; F21V 29/004; F21V 21/02; F21V 21/04; F21V 29/2212; F21V 7/22; F21V 29/83; F21V 37/002; F21V 7/00; F21L (Continued)

(56) **References Cited**

U.S. PATENT DOCUMENTS

- D32,722 S 7/1861 Schmidlin
 - D46,253 S 8/1914 Kopp
- (Continued)

FOREIGN PATENT DOCUMENTS

- CA 2034710 8/1991
 - CA 1314529 3/1993
- (Continued)

OTHER PUBLICATIONS

Apollo Horticulture GLRCTAC 6" Air Cool Tube Grow Light Deluxe Glass Cylinder with Hood Reflector, image post date Oct. 15, 2010, site visted Oct. 3, 2014, (online), <http://www.amazon.com/apollo-horticulture-glrectac-cylinder-reflector/dp/b003qkvv04/ref=pd_sbs_lg_5?ie=utf8&refrid=1y9v9qhh4n5vnctjmfr>.

(Continued)

Primary Examiner — Brian N Vinson
(74) *Attorney, Agent, or Firm* — J. Douglas Wells

(57) **CLAIM**

The ornamental design for a horticulture grow light, as shown and described.

DESCRIPTION

FIG. 1 is a perspective view of a horticulture grow light, as viewed from below, showing my new design;
 FIG. 2 is a perspective view of the light shown in FIG. 1, as viewed from above;
 FIG. 3 is a left side view of the light shown in FIG. 1;
 FIG. 4 is a right side view of the light shown in FIG. 1;
 FIG. 5 is a front elevation view of the light shown in FIG. 1;
 FIG. 6 is a rear elevation view of the light shown in FIG. 1;
 FIG. 7 is a bottom plan view of the light shown in FIG. 1; and,
 FIG. 8 is a top plan view of the light shown in FIG. 1.
 The broken-line disclosure shown in the views is understood to represent portions of the article in which the claimed design is embodied, but which form no part of the claimed design.

1 Claim, 6 Drawing Sheets

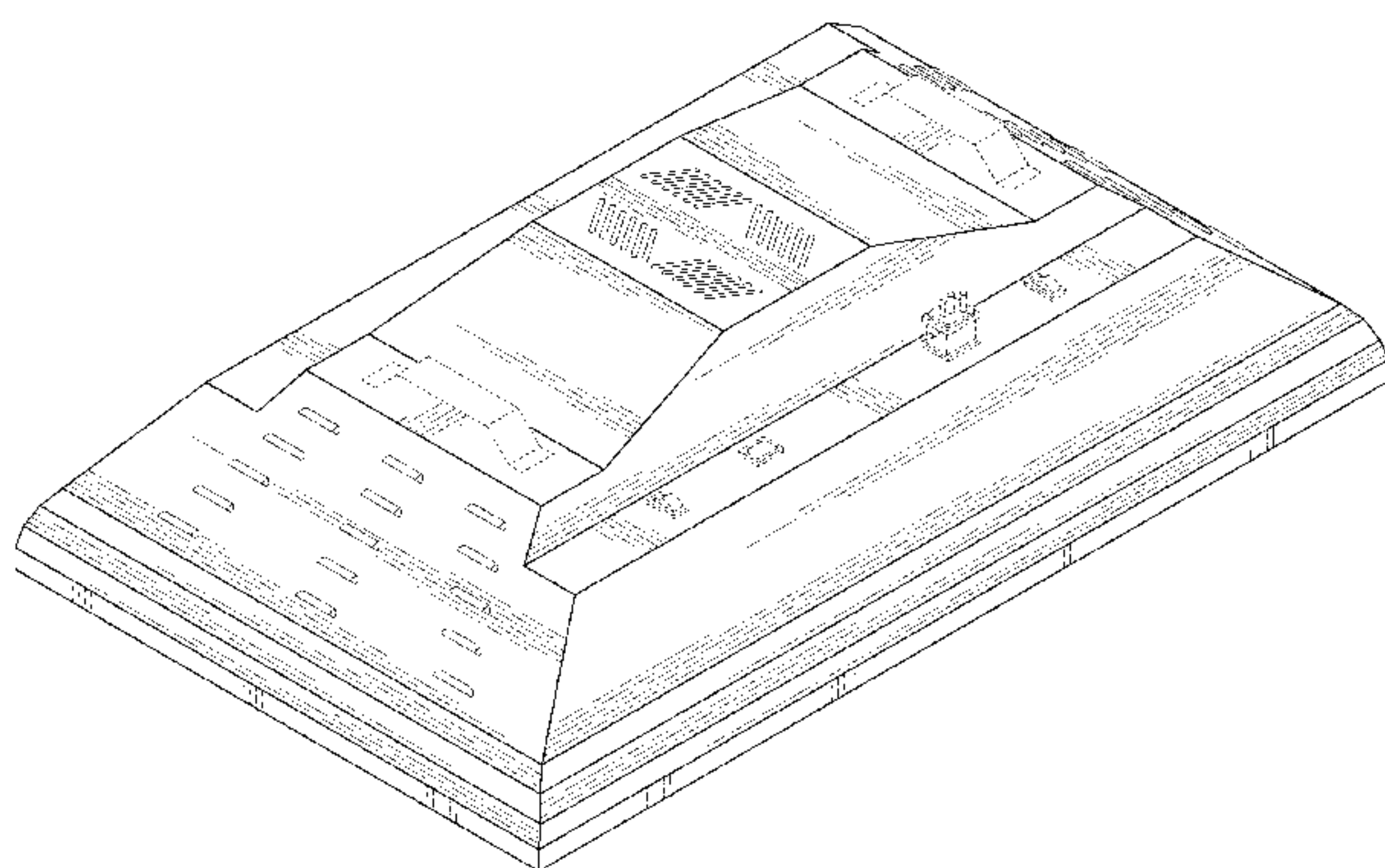
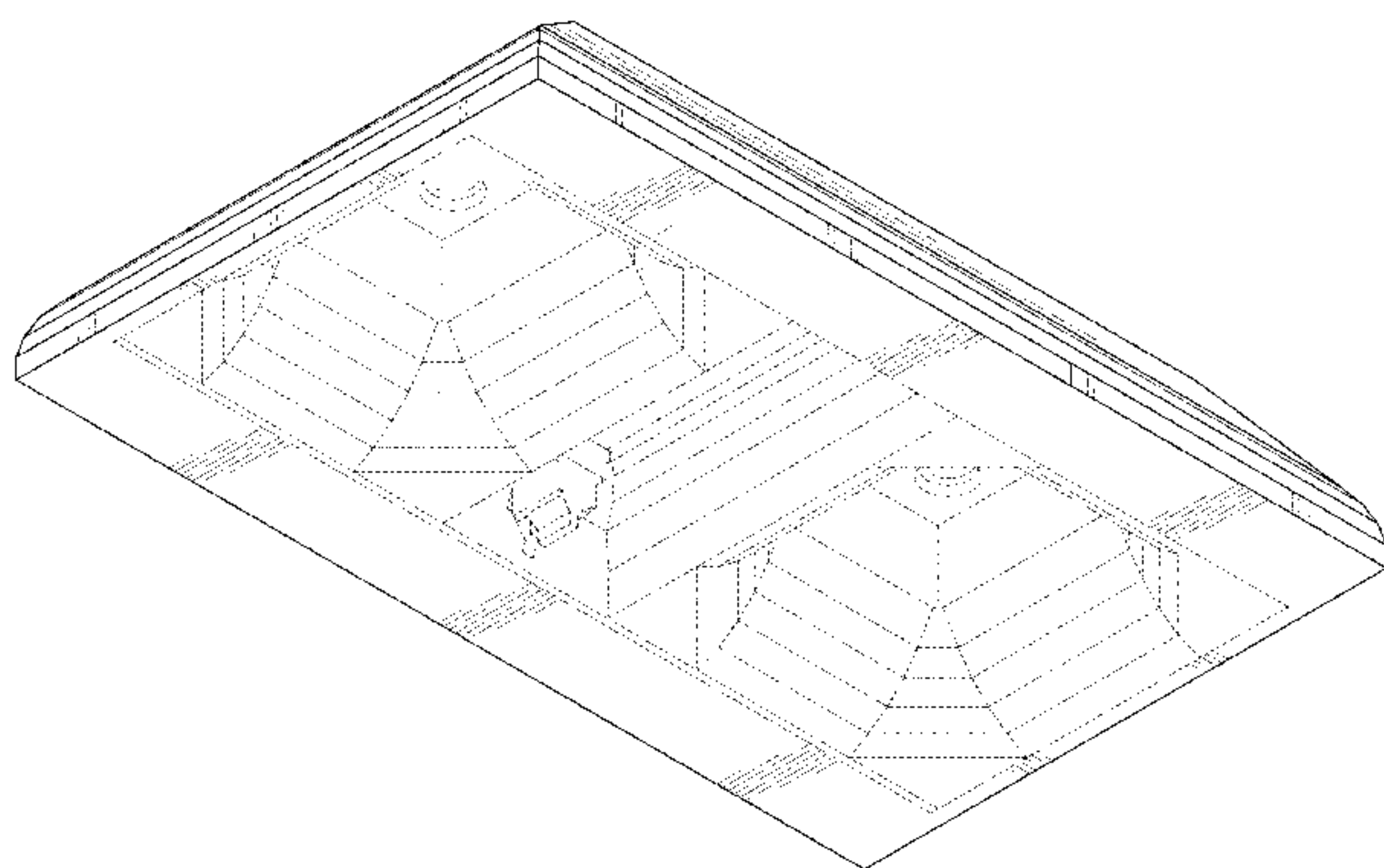

Related U.S. Application Data

continuation of application No. 29/531,242, filed on Jun. 24, 2015, now Pat. No. Des. 770,670.

- (58) **Field of Classification Search**
 CPC 19/00; F23D 11/443; F21Y 2101/02; A61L 9/037
 See application file for complete search history.

References Cited

U.S. PATENT DOCUMENTS

1,410,945 A 3/1922 Mayfield
 1,547,026 A 7/1925 Canney
 1,798,567 A 3/1931 Wagenhorst
 D85,049 S 9/1931 Kopp
 D85,382 S 10/1931 Guth
 1,848,734 A 3/1932 Luce
 1,873,310 A 8/1932 Doane
 1,930,070 A 10/1933 Zecher
 1,987,705 A 1/1935 Pedersen
 D106,614 S 10/1937 Waterbury
 2,194,841 A 3/1940 Welch
 D119,800 S 4/1940 Carter
 D123,768 S 12/1940 Scribner
 D125,559 S 3/1941 Biller
 2,242,590 A 5/1941 Marcel
 D128,049 S 7/1941 Kurtz
 D135,375 S 3/1943 Biller
 2,339,100 A 1/1944 Netting
 2,348,617 A 5/1944 Furedy
 D156,014 S 11/1949 Lazerson
 2,492,946 A 1/1950 Barber
 D174,221 S 3/1955 Hatch
 2,740,883 A 4/1956 Kruger
 2,741,694 A 4/1956 Wiig
 2,998,511 A 8/1961 Chan
 3,025,391 A 3/1962 Golko
 D193,802 S 10/1962 Thomsen
 D195,012 S 4/1963 Hoyle
 3,125,301 A 3/1964 Stotter
 3,263,071 A 7/1966 Fabbri
 3,272,978 A 9/1966 Jackson
 3,322,946 A 5/1967 Cooper
 3,420,995 A 1/1969 Dunckel
 D213,391 S 2/1969 Bruno
 3,433,941 A 3/1969 Hall
 3,675,008 A 7/1972 Hill
 3,684,883 A 8/1972 Entwistle
 3,701,898 A 10/1972 McNamara, Jr.
 3,755,667 A 8/1973 Price
 3,829,677 A 8/1974 DeLlano
 3,902,059 A 8/1975 McNamara, Jr.
 3,911,265 A 10/1975 Landrum
 4,028,542 A 6/1977 McReynolds, Jr.
 D245,016 S 7/1977 Barr
 4,037,096 A 7/1977 Brendgord
 4,078,169 A 3/1978 Armstrong
 4,175,360 A 11/1979 Mulvey
 4,229,782 A 10/1980 Ruud
 D259,738 S 6/1981 Boschetti
 4,308,573 A 12/1981 McNamara, Jr.
 D262,659 S 1/1982 Latta
 D266,578 S 10/1982 Moshier
 D268,287 S 3/1983 Boschetti
 D270,577 S 9/1983 DeVos
 4,446,506 A 5/1984 Larson
 4,531,180 A 7/1985 Hernandez
 4,616,293 A 10/1986 Baliozian
 4,669,033 A 5/1987 Lee
 D290,662 S 7/1987 Basil
 D300,877 S 4/1989 Cyr
 4,855,884 A 8/1989 Richardson
 4,893,221 A 1/1990 Friedman
 4,933,821 A 6/1990 Anderson
 4,939,629 A 7/1990 Glanton
 D311,597 S 10/1990 Poot

4,970,428 A 11/1990 Hayakawa
 4,980,809 A 12/1990 Baldwin
 D316,301 S 4/1991 Michael
 5,006,752 A 4/1991 Eggink
 5,065,294 A 11/1991 Poot
 5,072,349 A 12/1991 Waniga
 D323,897 S 2/1992 Compton
 5,088,015 A 2/1992 Baggio
 D329,104 S 9/1992 Dieperink
 D330,438 S 10/1992 Herst
 5,192,129 A 3/1993 Figueroa
 5,199,784 A 4/1993 Hempleman
 5,253,152 A 10/1993 Yang
 D349,358 S 8/1994 Herst
 5,353,746 A 10/1994 Del Rosario
 D352,126 S 11/1994 Ruud
 5,440,470 A 8/1995 Ly
 5,457,450 A 10/1995 Deese
 5,461,554 A 10/1995 Leonetti
 D365,159 S 12/1995 Tinen
 5,486,737 A 1/1996 Hrubowchak
 5,510,676 A 4/1996 Cottaar
 D373,000 S 8/1996 Brady
 5,555,162 A 9/1996 Shemitz
 D374,301 S 10/1996 Kleffiman
 5,568,680 A 10/1996 Parker
 5,570,947 A 11/1996 Felland
 D376,437 S 12/1996 Karlo
 D377,993 S 2/1997 Herst
 5,621,267 A 4/1997 Shaffner
 D383,243 S 9/1997 Fry
 5,698,947 A 12/1997 Choi
 5,702,179 A 12/1997 Sidwell
 D391,632 S 3/1998 Thomas
 D396,319 S 7/1998 Sutton
 D397,481 S 8/1998 Schafer
 D399,328 S 10/1998 Compton
 D399,329 S 10/1998 Compton
 D399,587 S 10/1998 Compton
 D400,289 S 10/1998 Wardenburg
 5,816,694 A 10/1998 Ideker
 D401,006 S 11/1998 Edwards
 D405,976 S 2/1999 Beall
 5,896,004 A 4/1999 Feldman
 5,924,789 A 7/1999 Thornton
 5,932,955 A 8/1999 Berger
 5,938,317 A 8/1999 Thornton
 D415,304 S 10/1999 Brown
 5,983,564 A 11/1999 Stragnola
 5,987,697 A 11/1999 Song
 5,999,943 A 12/1999 Nori
 D418,626 S 1/2000 Herst
 D419,248 S 1/2000 Lyons
 6,024,468 A 2/2000 Kassay
 6,042,250 A 3/2000 Stragnola
 6,051,927 A 4/2000 Graser
 6,053,624 A 4/2000 Cronk
 D425,237 S 5/2000 Scott
 D425,652 S 5/2000 Brok
 D426,010 S 5/2000 Compton
 6,061,690 A 5/2000 Nori
 6,065,849 A 5/2000 Chen
 6,070,173 A 5/2000 Huber
 6,076,944 A 6/2000 Maranon
 6,079,851 A 6/2000 Altman
 D428,516 S * 7/2000 Reo D26/118
 6,094,919 A 8/2000 Bhatia
 6,111,739 A 8/2000 Wu
 6,152,579 A 11/2000 Reed
 D439,008 S 3/2001 Kim
 6,210,025 B1 4/2001 Schmidt
 6,230,497 B1 5/2001 Morris
 D443,198 S 6/2001 Snyder
 D443,949 S 6/2001 DiMonte
 6,247,830 B1 6/2001 Winnett
 D445,943 S 7/2001 Littman
 6,257,735 B1 7/2001 Baar
 6,267,483 B1 7/2001 Hembery
 D447,272 S * 8/2001 Smith D26/118

(56)

References Cited

U.S. PATENT DOCUMENTS

6,279,012 B1	8/2001	Sexton		D614,801 S *	4/2010	Collins	D26/118
6,299,327 B1	10/2001	Camarota		7,722,228 B2	5/2010	Broer	
D452,559 S	12/2001	Schonberger		D617,028 S	6/2010	Verfuert	
6,343,984 B1	2/2002	Langdon		D620,190 S	7/2010	Chung	
6,371,630 B1	4/2002	Unger		D621,993 S	8/2010	Jong	
D456,927 S	5/2002	Russello		7,771,086 B2	8/2010	Goverde	
D456,928 S	5/2002	Russello		D628,335 S	11/2010	Hyland	
D456,938 S *	5/2002	Wardenburg	D26/118	7,854,534 B2	12/2010	Liu	
D459,825 S	7/2002	Field		D632,419 S	2/2011	Ng	
6,488,387 B2	12/2002	Wardenburg		D633,247 S	2/2011	Kong	
D469,564 S	1/2003	Brok		D633,640 S	3/2011	Wauters	
6,527,422 B1	3/2003	Hutchison		D634,060 S *	3/2011	Wardenburg	D26/118
6,548,948 B1	4/2003	Muessli		D634,240 S	3/2011	Junkeer	
6,595,662 B2	7/2003	Wardenburg		D634,468 S	3/2011	Hargreaves	
6,601,972 B2	8/2003	Sei		D634,469 S *	3/2011	Hargreaves	D26/118
6,658,652 B1	12/2003	Alexander		D637,162 S	5/2011	Bridgman	
6,679,619 B2	1/2004	Saieva		D637,341 S	5/2011	Wardenburg	
D486,593 S	2/2004	Griffin		D637,752 S	5/2011	Mekhtarian	
6,688,759 B1	2/2004	Hadjimichael		D640,404 S	6/2011	Chipperfield	
6,709,131 B1	3/2004	Herst		7,959,331 B2	6/2011	Ho	
6,729,383 B1	5/2004	Cannell		D641,100 S	7/2011	Li	
6,783,263 B1	8/2004	Cronk		7,972,044 B2	7/2011	Burkhauser	
D496,121 S	9/2004	Santoro		D644,185 S	8/2011	Hargreaves	
D499,504 S	12/2004	Meyer		7,987,632 B2	8/2011	May	
D499,505 S	12/2004	Benensohn		8,018,630 B2	9/2011	Herloski	
D504,343 S	4/2005	Ek		8,038,318 B2	10/2011	Plunk	
6,885,134 B2	4/2005	Kurashima		D648,652 S	11/2011	Hawkins	
6,908,212 B2	6/2005	Schultz		D649,685 S	11/2011	Trzesniowski	
7,011,424 B1	3/2006	Poulson		D650,515 S	12/2011	Bradley	
7,083,309 B2	8/2006	Chan		D650,935 S	12/2011	Beghelli	
7,101,060 B2	9/2006	Oppenheimer		8,113,696 B2	2/2012	Striebel	
7,131,753 B1	11/2006	Edwards, Jr.		D655,403 S	3/2012	Zakula	
7,156,539 B2	1/2007	Cronk		D657,748 S	4/2012	Hargreaves	
7,175,309 B2	2/2007	Craw		D660,252 S	5/2012	Hargreaves	
D542,460 S	5/2007	Hargreaves		D661,833 S	6/2012	Imajo	
D543,652 S *	5/2007	Hargreaves	D26/118	8,209,912 B2	7/2012	Hargreaves	
D543,654 S	5/2007	Hargreaves		8,215,799 B2	7/2012	Vanden Eynden	
D543,655 S	5/2007	Hargreaves		D667,584 S	9/2012	Beghelli	
7,213,948 B2	5/2007	Hein		D668,370 S	10/2012	Guercio	
D544,136 S	6/2007	Hargreaves		D671,259 S	11/2012	Chen	
D544,138 S	6/2007	Hargreaves		D672,908 S	12/2012	Wilcox	
D544,139 S	6/2007	Hargreaves		D672,911 S	12/2012	Mayfield, III	
D544,626 S	6/2007	Hargreaves		D673,324 S	12/2012	Mayfield	
D544,980 S	6/2007	Hargreaves		8,334,640 B2	12/2012	Reed	
D544,981 S	6/2007	Hargreaves		D675,369 S *	1/2013	Michaud	D26/118
D544,982 S	6/2007	Hargreaves		8,348,481 B2	1/2013	Chang	
D544,983 S	6/2007	Hargreaves		D675,772 S	2/2013	Tran	
D544,984 S	6/2007	Hargreaves		8,371,726 B2	2/2013	Collins	
D544,985 S	6/2007	Hargreaves		D678,597 S	3/2013	Lehman	
D544,987 S	6/2007	Hargreaves		D678,599 S	3/2013	Boyer	
D544,994 S	6/2007	Hargreaves		D679,848 S	4/2013	Pickard	
D544,995 S *	6/2007	Hargreaves	D26/118	D683,064 S	5/2013	Tuck	
D545,460 S	6/2007	Mason, II		8,505,224 B2	8/2013	Huang	
D545,484 S *	6/2007	Hargreaves	D26/118	D689,238 S	9/2013	Halsey	
D545,485 S *	6/2007	Hargreaves	D26/118	D690,875 S	10/2013	McKenzie	
D545,990 S	7/2007	Hargreaves		D693,959 S *	11/2013	Boyer	D26/118
D545,994 S	7/2007	Hargreaves		D697,663 S	1/2014	Speier	
D545,996 S	7/2007	Hargreaves		D698,074 S	1/2014	Hargreaves	
D549,869 S	8/2007	Ward		D698,075 S	1/2014	Klus	
7,296,914 B1	11/2007	Russello		D698,986 S *	2/2014	Reynolds	D26/118
7,360,927 B2	4/2008	Oka		D698,987 S	2/2014	Stanley	
D569,024 S	5/2008	Redfern		D699,386 S	2/2014	Park	
D572,858 S	7/2008	Santoro		D702,827 S	4/2014	Mase	
7,445,363 B2	11/2008	Vanden Eynden		8,702,283 B2	4/2014	Bradley, Jr.	
7,524,090 B2	4/2009	Hargreaves		D705,474 S	5/2014	Philips	
7,534,011 B2	5/2009	Townsley		D705,974 S	5/2014	Blessitt	
D595,894 S	7/2009	Verfuert		8,723,086 B2	5/2014	McMahan	
D602,625 S	10/2009	Santoro		D707,385 S	6/2014	Wardenburg	
D603,087 S	10/2009	Mo		D708,390 S	7/2014	Roos	
7,617,057 B2	11/2009	May		D710,528 S	8/2014	Wardenburg	
D605,342 S	12/2009	Chung		8,801,235 B2	8/2014	Yurich	
D608,490 S	1/2010	Chung		D713,953 S	9/2014	Jepson	
7,641,367 B2	1/2010	Hargreaves		D714,988 S	10/2014	Park	
7,654,702 B1	2/2010	Ding		D715,994 S	10/2014	Klus	
D613,900 S	4/2010	Hargreaves		D716,995 S	11/2014	Zhu	
				D717,487 S	11/2014	Guzzini	
				D717,636 S	11/2014	Stanley	
				D720,488 S	12/2014	Toyohisa	
				D720,505 S	12/2014	Kersten	

(56)

References Cited

U.S. PATENT DOCUMENTS

8,905,575 B2 * 12/2014 Durkee F21V 7/0008
362/218

D720,876 S 1/2015 Haverfield
D721,844 S 1/2015 Lay
D722,654 S 2/2015 Martone
D725,819 S 3/2015 Reynolds
D725,820 S 3/2015 Hargreaves
8,967,821 B2 3/2015 Pickard
D726,359 S 4/2015 Grigore
8,998,473 B1 4/2015 Anderson
9,016,892 B1 4/2015 Scribante
9,016,907 B2 4/2015 Stanley
D728,848 S 5/2015 Reyes
D729,435 S 5/2015 Arndt
D730,556 S 5/2015 Toyohisa
D731,103 S 6/2015 Wilke
D731,109 S 6/2015 Wardenburg
D731,701 S * 6/2015 Hargreaves D26/118
D732,233 S 6/2015 Reynolds
D732,234 S 6/2015 Rashidi Doust
D732,235 S * 6/2015 Reynolds D26/118
D732,236 S * 6/2015 Reynolds D26/118
D733,347 S 6/2015 Dungan
D733,952 S 7/2015 Lay
D733,960 S 7/2015 Howe
D734,534 S 7/2015 Howe
D735,391 S 7/2015 Blessitt
D735,401 S 7/2015 Clements
D736,450 S * 8/2015 Reynolds D26/118
D737,498 S 8/2015 Stanley
9,110,209 B2 8/2015 Blessitt
D738,031 S 9/2015 Martins
D739,595 S 9/2015 Reynolds
9,127,826 B2 9/2015 Boyer
D740,486 S * 10/2015 Stanley D26/118
D740,996 S 10/2015 Tragatschnig
D745,993 S 12/2015 Reynolds
D747,029 S * 1/2016 Reynolds D26/118
D747,538 S 1/2016 Hargreaves
D747,825 S 1/2016 Reynolds
D747,923 S 1/2016 Cornu
D748,319 S 1/2016 Johnson
D748,320 S 1/2016 Johnson
D748,847 S 2/2016 Johnson
D748,849 S * 2/2016 Stanley D26/118
D748,850 S 2/2016 Johnson
D749,773 S 2/2016 Waible
D750,312 S 2/2016 Reynolds
D750,313 S 2/2016 Reynolds
D750,316 S * 2/2016 Reynolds D26/118
9,255,690 B2 2/2016 Dimitriadis
D750,831 S 3/2016 Clements
D751,244 S * 3/2016 Reynolds D26/118
D751,245 S 3/2016 Stanley
D751,247 S * 3/2016 Reynolds D26/118
D753,654 S 4/2016 Eastwood
9,310,037 B2 4/2016 Cercone
D756,016 S 5/2016 Hargreaves
D756,023 S 5/2016 Hoffer
D756,026 S 5/2016 Reynolds
D757,323 S 5/2016 Reynolds
D757,326 S 5/2016 Reynolds
D757,346 S 5/2016 Stanley
9,335,038 B2 5/2016 Stanley
9,366,947 B2 6/2016 Miyata
D762,320 S 7/2016 Reynolds
D765,306 S 8/2016 Wardenburg
D766,756 S 9/2016 Franc
D769,513 S 10/2016 Reynolds
D769,514 S 10/2016 Reynolds
D770,079 S 10/2016 Stanley
D770,082 S 10/2016 Reynolds
D770,670 S 11/2016 Reynolds
D770,671 S 11/2016 Reynolds
D771,301 S 11/2016 Stanley

D771,304 S 11/2016 Goltche
D773,107 S 11/2016 Stanley
D775,406 S 12/2016 Hargreaves
D775,760 S 1/2017 Reynolds
D780,985 S 3/2017 Stanley
D780,986 S 3/2017 Reynolds
D781,492 S 3/2017 Reynolds
D783,887 S 4/2017 Stanley
D786,488 S 5/2017 Reynolds
D786,489 S 5/2017 Stanley
D786,490 S 5/2017 Stanley
2002/0073285 A1 6/2002 Butterworth
2002/0141195 A1 10/2002 Peter
2003/0031011 A1 2/2003 Miller
2003/0191783 A1 10/2003 Wolczko
2004/0240214 A1 12/2004 Whitlow
2005/0117333 A1 6/2005 Yoshida
2005/0160481 A1 7/2005 Todd
2005/0233691 A1 10/2005 Horton
2006/0231081 A1 10/2006 Kirakosyan
2006/0232984 A1 10/2006 Schuknecht
2006/0282457 A1 12/2006 Williams
2007/0051321 A1 3/2007 Chang
2007/0070633 A1 3/2007 Eynden
2007/0228993 A1 10/2007 Stuer
2007/0246631 A1 10/2007 Brown
2007/0282806 A1 12/2007 Hoffman
2008/0059799 A1 3/2008 Scarlata
2008/0117617 A1 5/2008 Hargreaves
2008/0130304 A1 6/2008 Rash
2008/0205030 A1 8/2008 Hargreaves
2008/0205071 A1 8/2008 Townsley
2008/0212326 A1 9/2008 Chon
2008/0278950 A1 11/2008 Pickard
2008/0278957 A1 11/2008 Pickard
2009/0116250 A1 5/2009 Hargreaves
2009/0231840 A1 9/2009 Boehme
2009/0262540 A1 10/2009 Hargreaves
2009/0276478 A1 11/2009 Soman
2009/0310373 A1 12/2009 Burkhauser
2009/0316404 A1 12/2009 Mo
2009/0323335 A1 12/2009 Yang
2010/0214789 A1 8/2010 Hawkes
2010/0238661 A1 9/2010 Pfund
2010/0277908 A1 11/2010 Hu
2010/0277929 A1 11/2010 Hargreaves
2010/0295468 A1 11/2010 Pedersen
2010/0302768 A1 12/2010 Collins
2011/0169412 A1 7/2011 Yurich
2011/0203096 A1 8/2011 Hargreaves
2011/0259665 A1 10/2011 Morgan
2012/0051041 A1 3/2012 Edmond
2012/0092859 A1 4/2012 Gregoris
2012/0145699 A1 6/2012 McMahan
2012/0212883 A1 8/2012 Hargreaves
2012/0230035 A1 9/2012 Bradley, Jr.
2013/0077329 A1 3/2013 Hessling
2013/0083539 A1 4/2013 Dimitriadis
2013/0155685 A1 6/2013 Stanley
2013/0242573 A1 9/2013 Petrsoiki
2013/0250567 A1 9/2013 Edmond
2014/0378283 A1 12/2014 Qiu
2015/0023022 A1 1/2015 Stanley
2015/0098215 A1 4/2015 Torabifard
2015/0252992 A1 9/2015 Stanley
2015/0252993 A1 9/2015 Stanley
2015/0252994 A1 9/2015 Stanley
2015/0260381 A1 9/2015 Verfuert

FOREIGN PATENT DOCUMENTS

EP 0325003 7/1989
EP 0440274 8/1991
WO 02063210 8/2002
WO 03060379 7/2003
WO 2008018000 2/2008

(56)

References Cited

FOREIGN PATENT DOCUMENTS

WO	2009096775	8/2009
WO	2011119451	9/2011

OTHER PUBLICATIONS

Apollo Horticulture GLRLS24 6" Air Cooled Hydroponic Grow Light Glass Reflector Hood, image post date Oct. 15, 2010, site visited Oct. 3, 2014, (online), <http://www.amazon.com/apollo-horticulture-GLRLS24-hydroponic-reflector/dp/B00BMVK8HG/ref=cm_cd_ql_qh_dp_i>.

Adjustable Reflector, image post date Apr. 23, 2012, site visited Sep. 23, 2015, http://web.archive.org/web/2012043260757/http://hydroponics-products.en.alibaba.com/product/519225678-213056444/adjustable_reflector_grow_light_hydroponics_greenhouse_horticulture_reflector_hood.html.

Agrotech Magnum Reflector, image post date Feb. 5, 2012, site visited Oct. 31, 2014, www.hydroponics.net/i/136580.

Cree CR22, image post date Apr. 28, 2011, site visited Nov. 15, 2014, <http://ledsmagazine.com/content/dam/leds/migrated/objects/news/8/4/19/cree204272011.jpg>.

ZR series High Efficacy Troffer, image post date Apr. 13, 2012, site visited Oct. 31, 2014, www.cree.com/lighting/products.

Grow Lights Home Depot: Find many types of grow lights for your plant, published Dec. 22, 2012, online. Site visited Jun. 25, 2014. [Http://besthomedecorfurniture.com/gardening-decor/grow-lights-home-depot-few-things-to-consider-when-buying-grow-lighting-plants-online.html](http://besthomedecorfurniture.com/gardening-decor/grow-lights-home-depot-few-things-to-consider-when-buying-grow-lighting-plants-online.html).

LED Grow Light Comparison Test Review, Youtube.com, published Jun. 29, 2012, online. Site visited Jun. 25, 2014. www.youtube.com/watch?v=f-8oy0qbgrs.

Illuminator Pro-Series Hybrid 350W, wordpress.com, published Dec. 22, 2010, online, site visited Jun. 25, 2014. <http://growsetup.wordpress.com/category/grow-lights/>.

California Lightworks New SolarStorm 440W LED Grow Light with UVB, hydrobuilder.com, online. Site visited Jun. 25, 2014. http://hydrobuilder.com/solarstorm-440w-led-grow-light-with-uvb.html?dzid=strands_CLW-SS-440.

2013 Sunlight Supply Cataog, Issuu.com, published Aug. 1, 2013, online. Site visited Feb. 2, 2015. http://issuu.com/sunlightsupply/docs/2013_sunlightproductcatalog/49.

Pages 29 and 54 from 2014-2015 dealer catalog showing and describing Super Sun DE reflector published by Sunlight Supply, Inc. 2014.

Dominator XXXL Non AC Reflector pack of 3 Spec Sheet, GreenTreesHydroponics.com, date available Mar. 12, 2014, online. Site visited Feb. 3, 2015, <https://www.hydroponics.net/i/141477>.

Low Rider Air-Cooled Reflector—TinEye, image post date Oct. 11, 2012, site visited Oct. 1, 2015, www.tineye.com/search/1b0e187c5ed9e4e9cfb55d0472271385a2c0e88/?pluginver.

OG Air Cooled Parabolic Reflector Only—Make the Most of Your Grow Light, GroWell Hydroponics, <http://www.growell.co.uk/og-air-cooled-parabolic-reflector-only.html>, pp. 1-2, accessed Aug. 26, 2014.

Air Resistance: Distinguishing Between Laminar and Turbulent Flow, www.docstoc.com, Dec. 29, 2010, pp. 1-6.

Sun Systems LEC 630 Light Emitting Ceramic Fixture, Spec Sheet for 906217—Sun System LEC 630 120 Volt w/3100 K Lamps, www.sunlightsupply.com/shop/bycategory/led-lighting/sun-system-lec-630-light-emitting-ceramic-fixture, online, updated Feb. 9, 2015. Site visited Mar. 30, 2015, p. 1.

Mohri, Mineko, International Preliminary Report on Patentability for PCT/US2014/014959, Jan. 19, 2016.

A3V Reflector, Titaness Light Shop, www.titanesslightshop.com/products-page/reflectors/a3v-reflector, online. Site visited Jan. 14, 2015.

G2V Grow Light Reflector, Titaness Light Shop, www.titanesslightshop.com/products-page/reflectors/g2v-grow-light-reflector, online. Site visited Jan. 14, 2015.

1000 Watt Galaxy Grow Amp Double Ended Grow Light Packages, image post date Jan. 30, 2014, site visited Jul. 8, 2016, <<http://www.ehydroponics.com/100-watt-galaxy-grow-amp-double-ended-grow-light-package.html>>.

2009-10-watt-light-set—TinEye, image post date May 23, 2012, site visited Jul. 8, 2016, <<https://www.tineye.com/search/2de39cf51f7a031139a80ce555e2f30d0abd5216/>>.

Square 10 Watt LED Grow Light, image post date Aug. 1, 2011, site visited Jul. 8, 2016, <<http://www.dhgate.com/store/product/hydroponic-vegetable-10-watt-led-grow-light/216755031.html>>.

Sun System 630 Ceramic Metal Halide 120v Specifications, GrowersHouse.com, update on Sep. 9, 2014, Online. Site visited Feb. 3, 2015. <http://growershouse.com/aitdownloadablefiles/download/aithle/aifile_id/583/>.

Growlite HDE 600W-1000W Double Ended Lamp Concealed Vacuum Airflow Technology, Indoor Grow Science, site visited Aug. 3, 2016, <<http://www.indoorgrowscience.net/downloads/specs/hde.pdf>>.

Sun Systems LEC 315—Reviews?, rollitup.com forum, published Oct. 23, 2013, online. Visited Nov. 8, 2016. <<http://rollitup.org/t/sun-sytems-lec-315-reviews.742794>>.

Sun System LEC 315 120v Light Emitting Ceramic Metal Halide Fixture w/ Free Ratchet Light Hangers, Amazon.com, earliest review of Jul. 2, 2014, online. Visited Nov. 8, 2016 <<https://www.amazon.com/sun-sysem-emitting-ceramic-fixture/dep/B00HBCV8TM>>.

LEC 315 Watt Grow Light Great Yield Reports!, YouTube.com, published Mar. 31, 2014, online. Visited Nov. 8, 2016. <<https://www.youtube.com/watch?v=QqcoW19KnUk>>.

Air Cooled Grow Lights, greensteamhydroponics.com, published May 24, 2014, online. Site visited Nov. 16, 2016. <http://web.archive.org/web/20140524103407/http://www.greensteamhydroponics.com/aircooled-reflector-range-from-greenstream-hydroponics/prod_699.html>.

greensteamhydroponics.com/aircooled-reflector-range-from-greenstream-hydroponics/prod_699.html>.

* cited by examiner

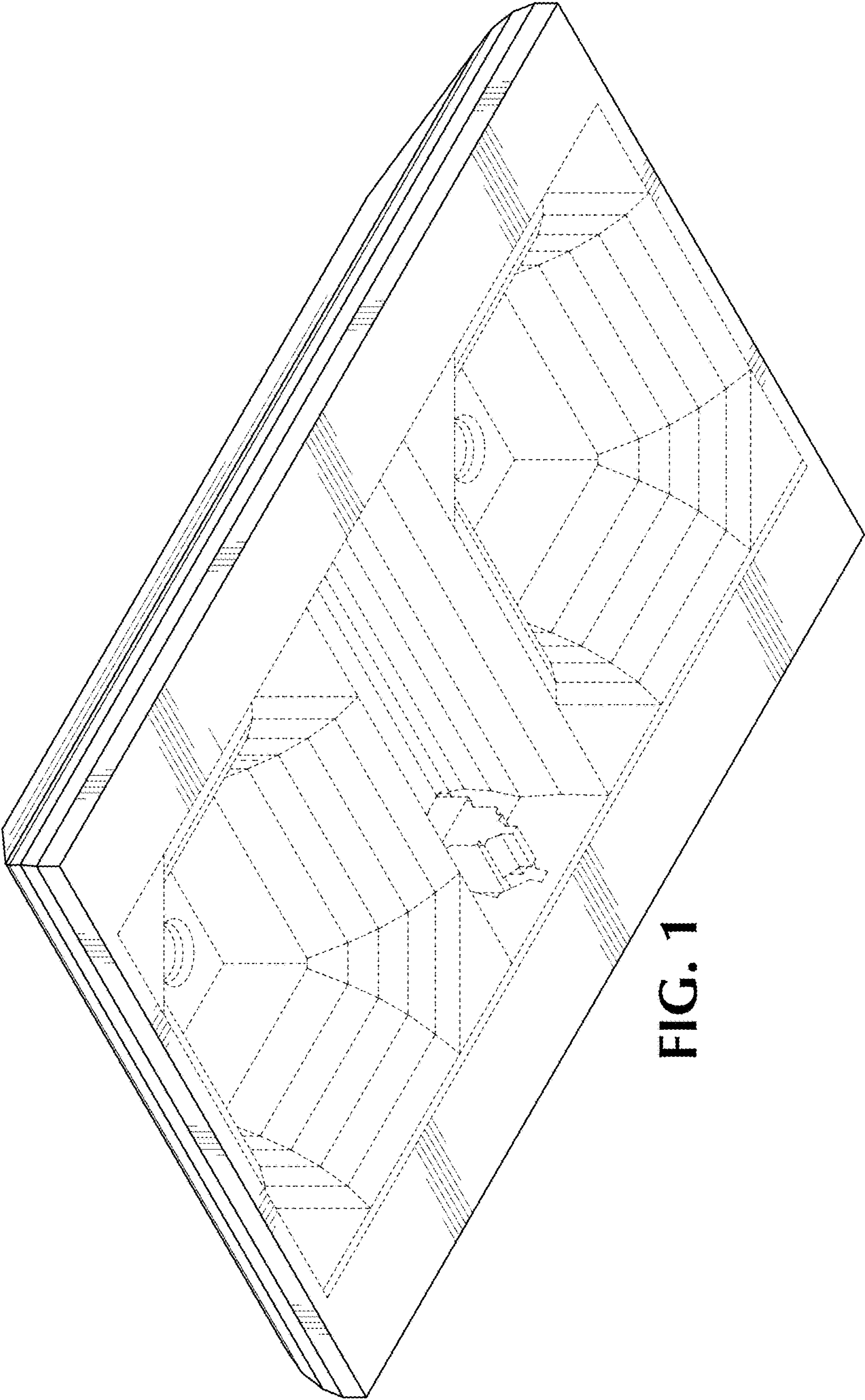

FIG. 1

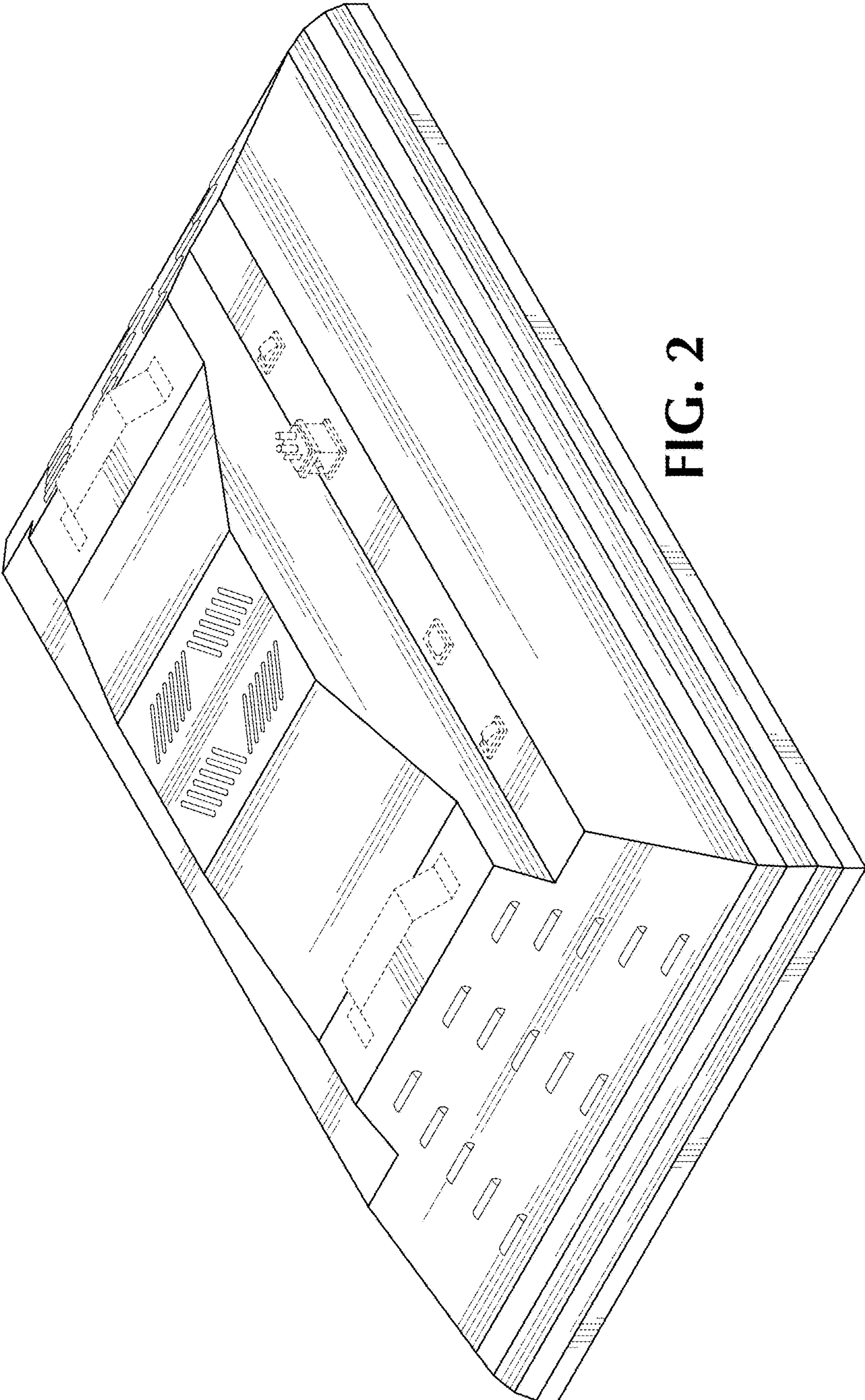

FIG. 2

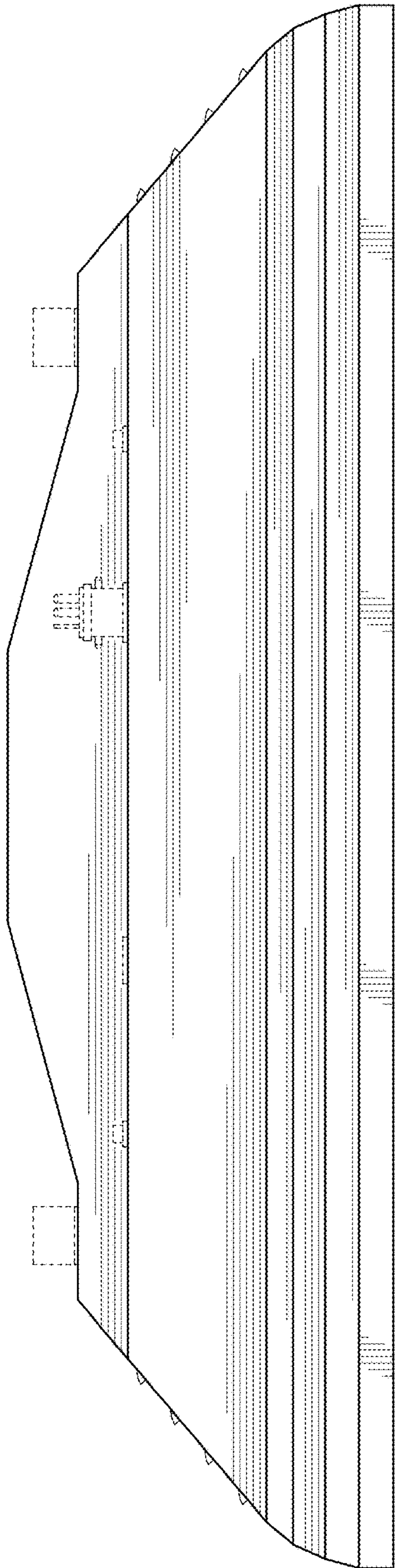

FIG. 3

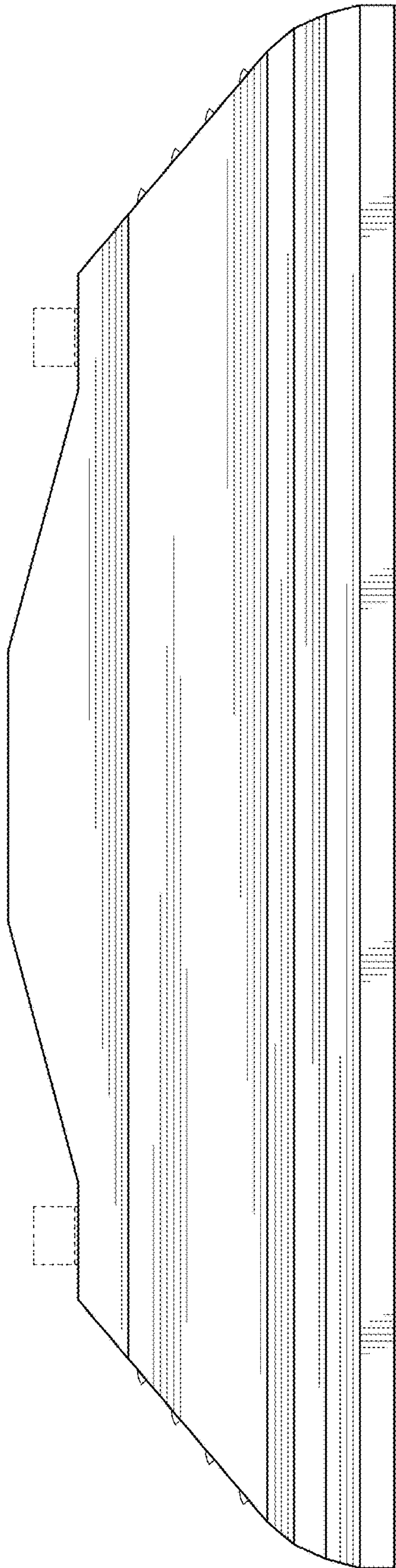

FIG. 4

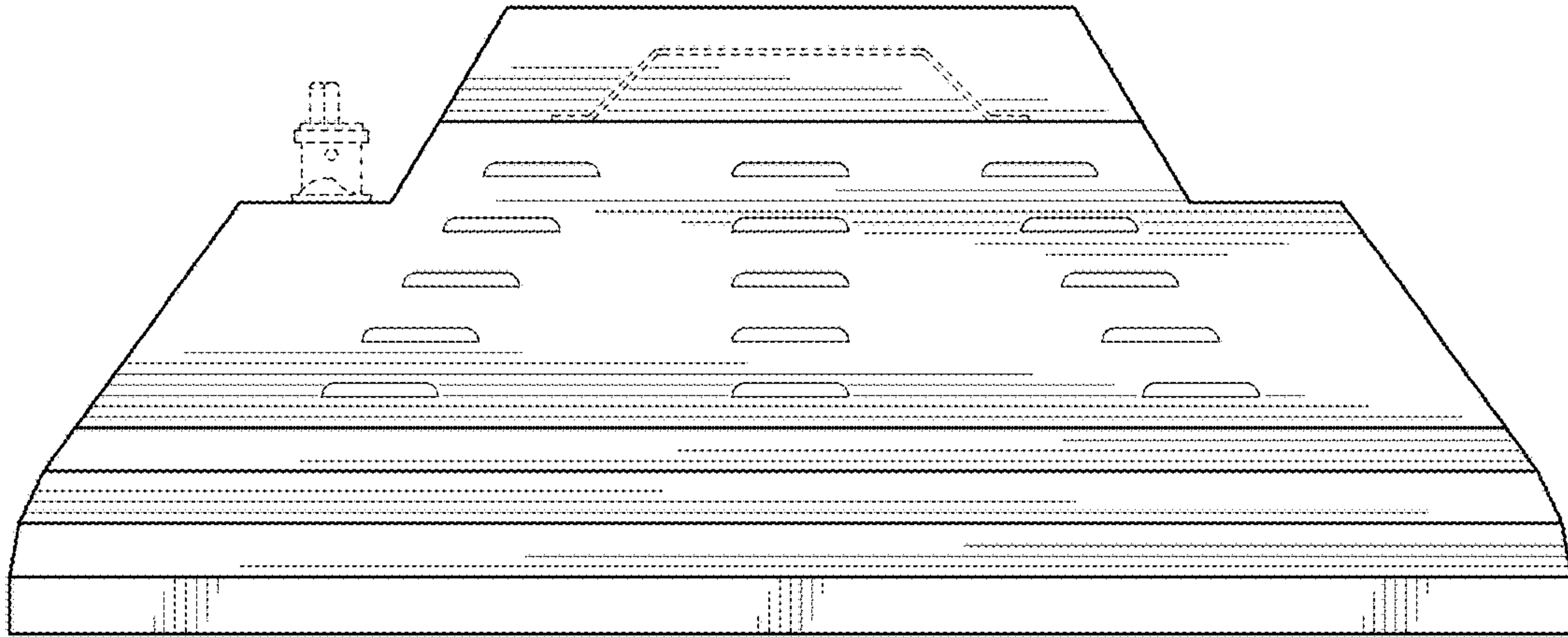

FIG. 5

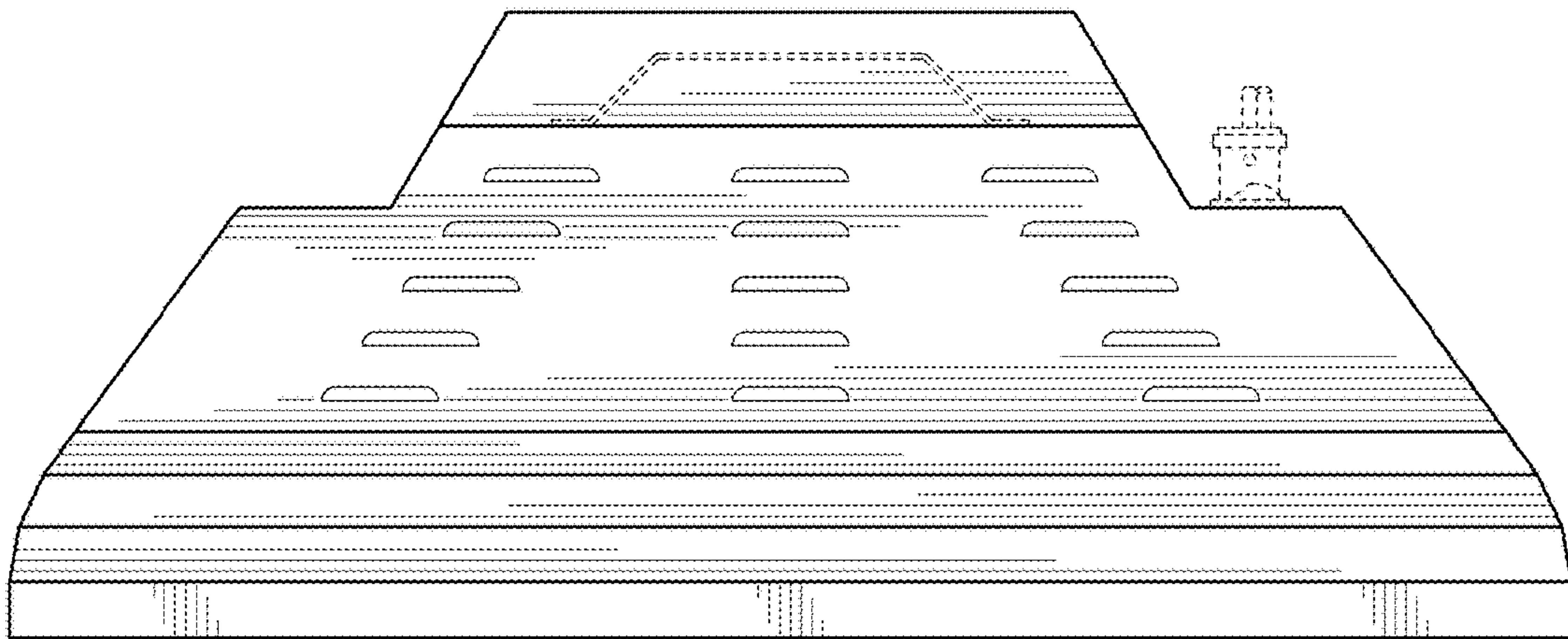

FIG. 6

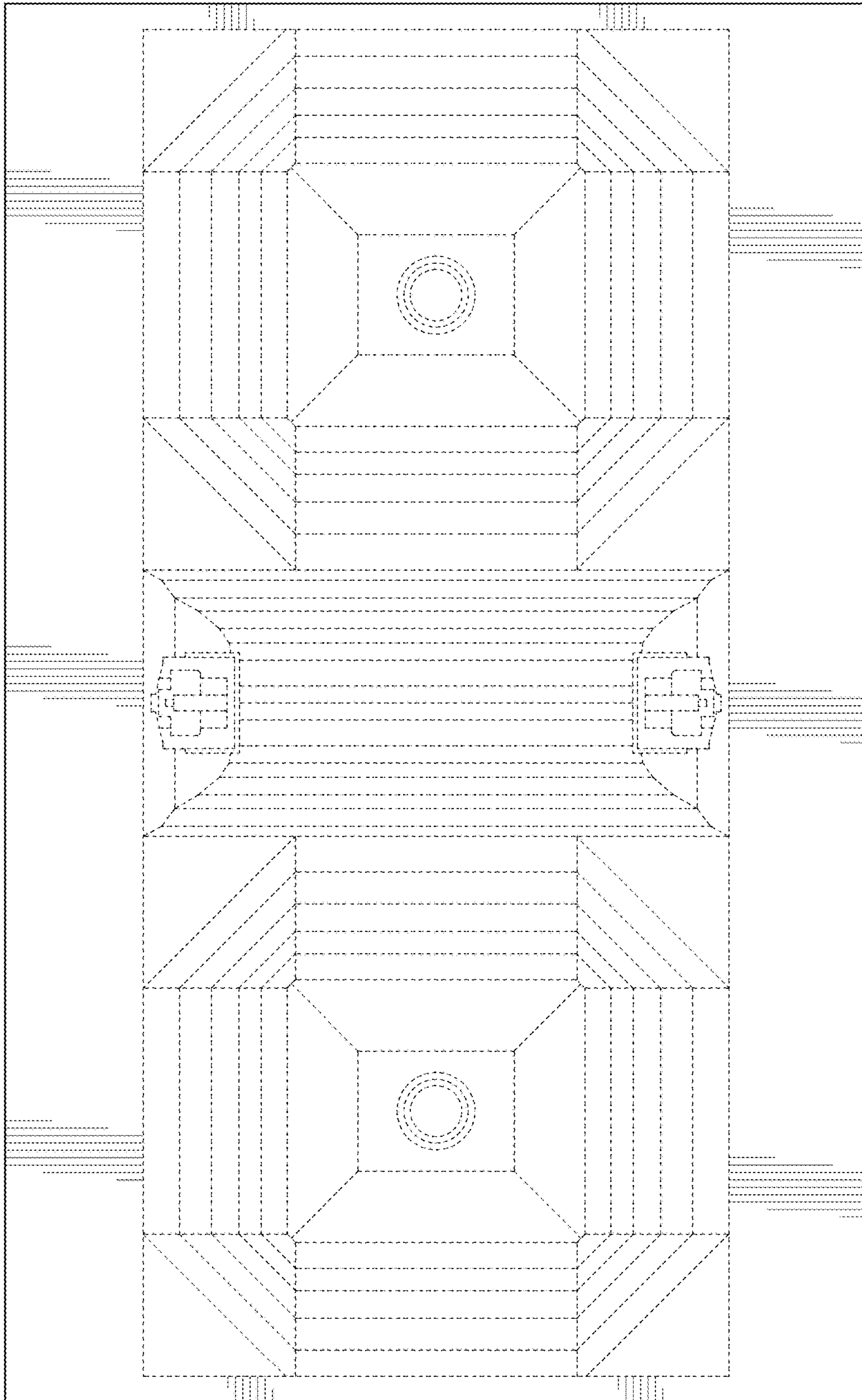

FIG. 7

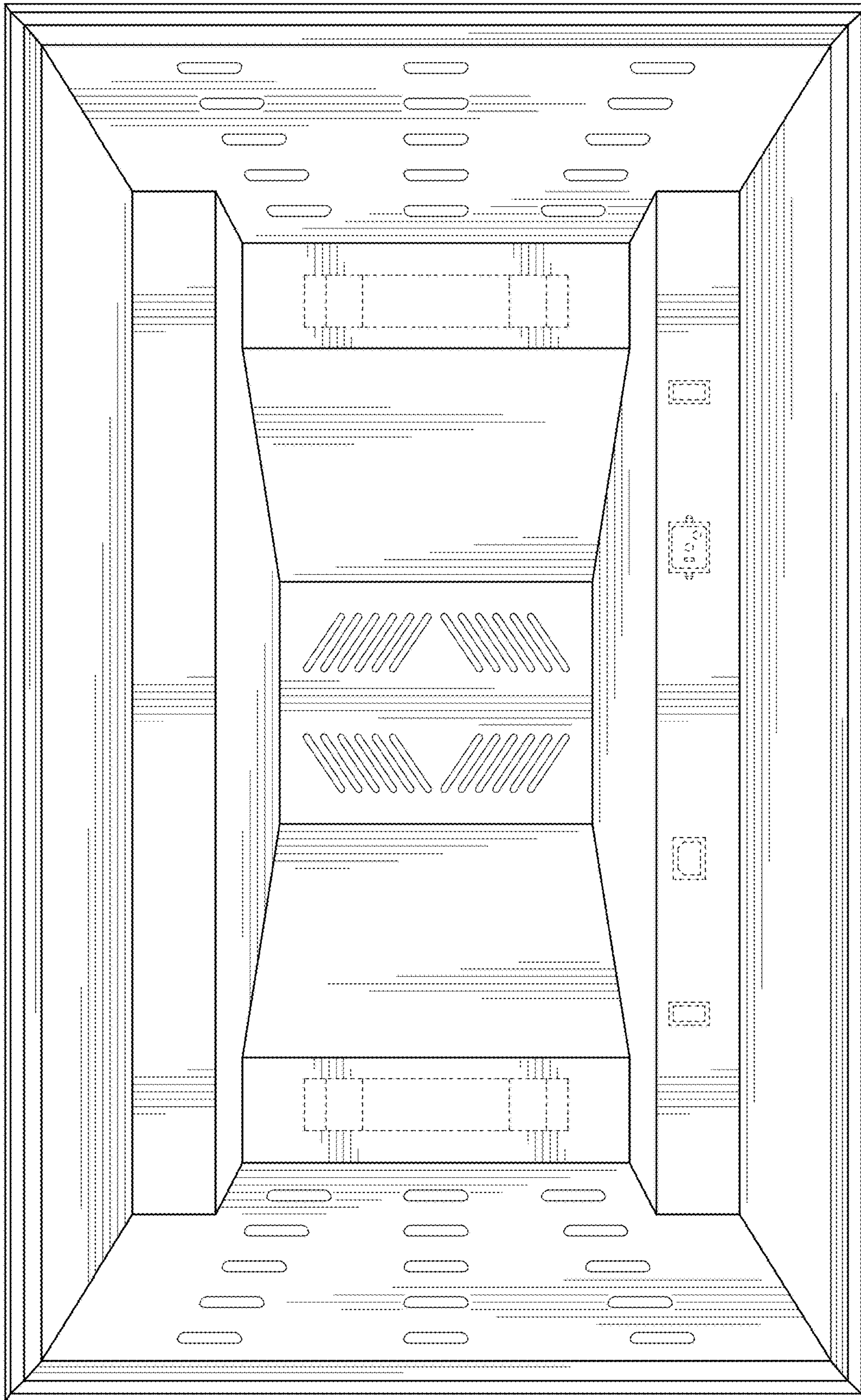

FIG. 8