



US00D802749S

(12) **United States Design Patent**  
**Bainton et al.**

(10) **Patent No.:** **US D802,749 S**

(45) **Date of Patent:** **\*\* Nov. 14, 2017**

(54) **INJECTION DEVICE**

(71) Applicant: **SANOFI SA**

(72) Inventors: **Mike Cameron Bainton**, Warwickshire (GB); **Robert F. Veasey**, Warwickshire (GB)

(73) Assignee: **SANOFI**, Paris (FR)

(\*\*) Term: **14 Years**

(21) Appl. No.: **29/520,727**

(22) Filed: **Mar. 17, 2015**

(30) **Foreign Application Priority Data**

Sep. 23, 2014 (EM) ..... 002542852

(51) **LOC (10) Cl.** ..... **24-02**

(52) **U.S. Cl.**  
USPC ..... **D24/113**

(58) **Field of Classification Search**

USPC ..... D24/127-131, 112-114, 133, 186;  
606/181, 185; 604/264, 523-528, 272,  
604/187, 158, 164.01-164.11, 181, 184,  
604/227; 600/101, 139, 143;  
128/200.24, 207.14, 207.15  
CPC ..... A61M 5/178; A61M 3/00; A61M 5/20;  
A61M 5/31; A61M 5/3146; A61M  
5/3129; A61M 5/3148; A61M 5/315

See application file for complete search history.

(56) **References Cited**

**U.S. PATENT DOCUMENTS**

D365,881 S \* 1/1996 Tiefenthal ..... D24/158  
D371,605 S \* 7/1996 Wong ..... D24/169

D393,271 S \* 4/1998 Conner ..... D16/130  
D439,657 S \* 3/2001 Bridle ..... D24/113  
D440,309 S \* 4/2001 Whiteside ..... D24/131  
D447,282 S \* 8/2001 Yiu ..... D24/133  
6,379,339 B1 \* 4/2002 Klitgaard ..... A61M 5/3129  
604/207  
D623,740 S \* 9/2010 Harris ..... D24/133  
D633,201 S \* 2/2011 Lee ..... D24/129  
D676,549 S \* 2/2013 Lovell ..... D24/113  
8,394,117 B2 \* 3/2013 Hein ..... A61B 5/1411  
606/181  
D681,195 S \* 4/2013 Skulley ..... D24/113  
D725,261 S \* 3/2015 Barrett ..... D24/129

\* cited by examiner

*Primary Examiner* — David Muller

(74) *Attorney, Agent, or Firm* — McDonnell Boehnen  
Hulbert & Berghoff LLP

(57) **CLAIM**

The ornamental injection device, as shown and described.

**DESCRIPTION**

FIG. 1 is a top view of the injection device;  
FIG. 2 is a bottom view of the injection device;  
FIG. 3 is a right side view of the injection device;  
FIG. 4 is a left side view of the injection device;  
FIG. 5 is front end view of the injection device;  
FIG. 6 is a rear end view of the injection device; and,  
FIG. 7 is a perspective view of the injection device from the front and right.

The broken lines shown in the figures are for the purpose of illustrating portions of the article and forms no part of the claimed design. The broken line, which defines the bounds of the claimed invention, forms no part of the claimed design.

**1 Claim, 6 Drawing Sheets**

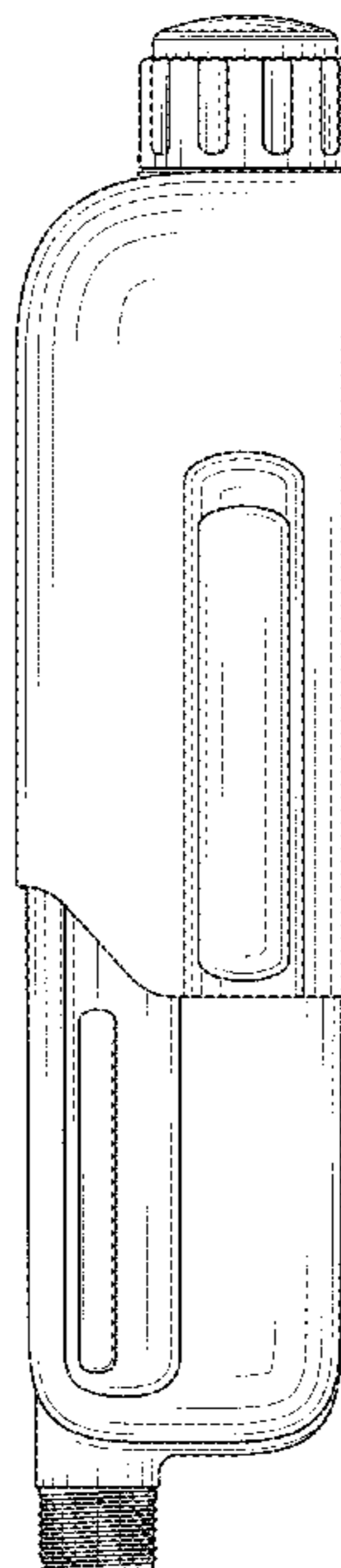

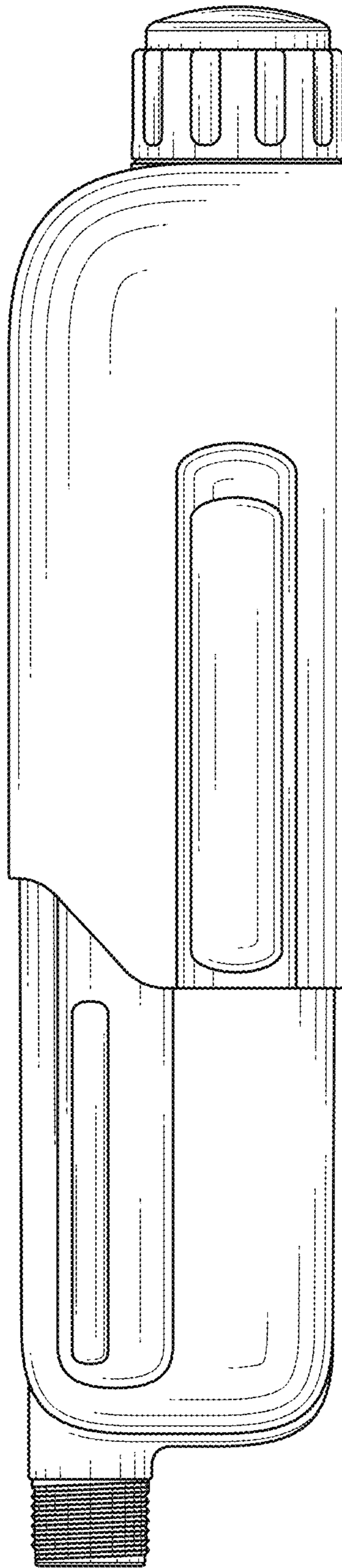

FIG. 1

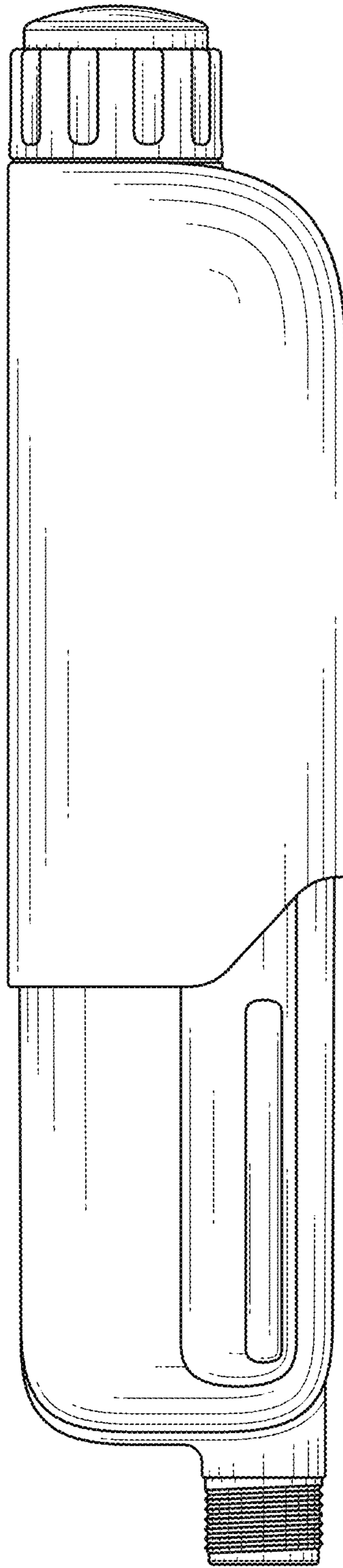

FIG. 2

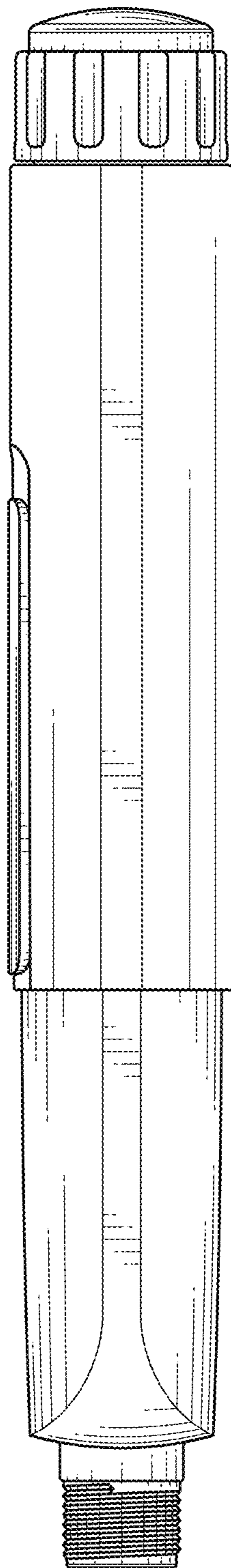

FIG. 3

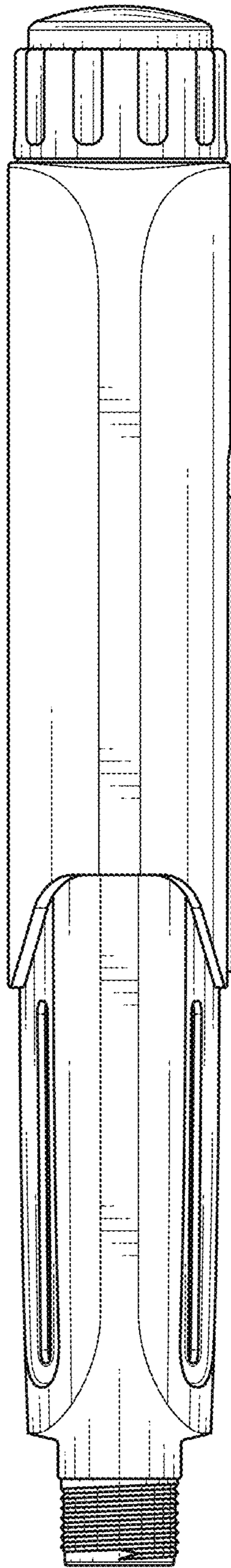

FIG. 4

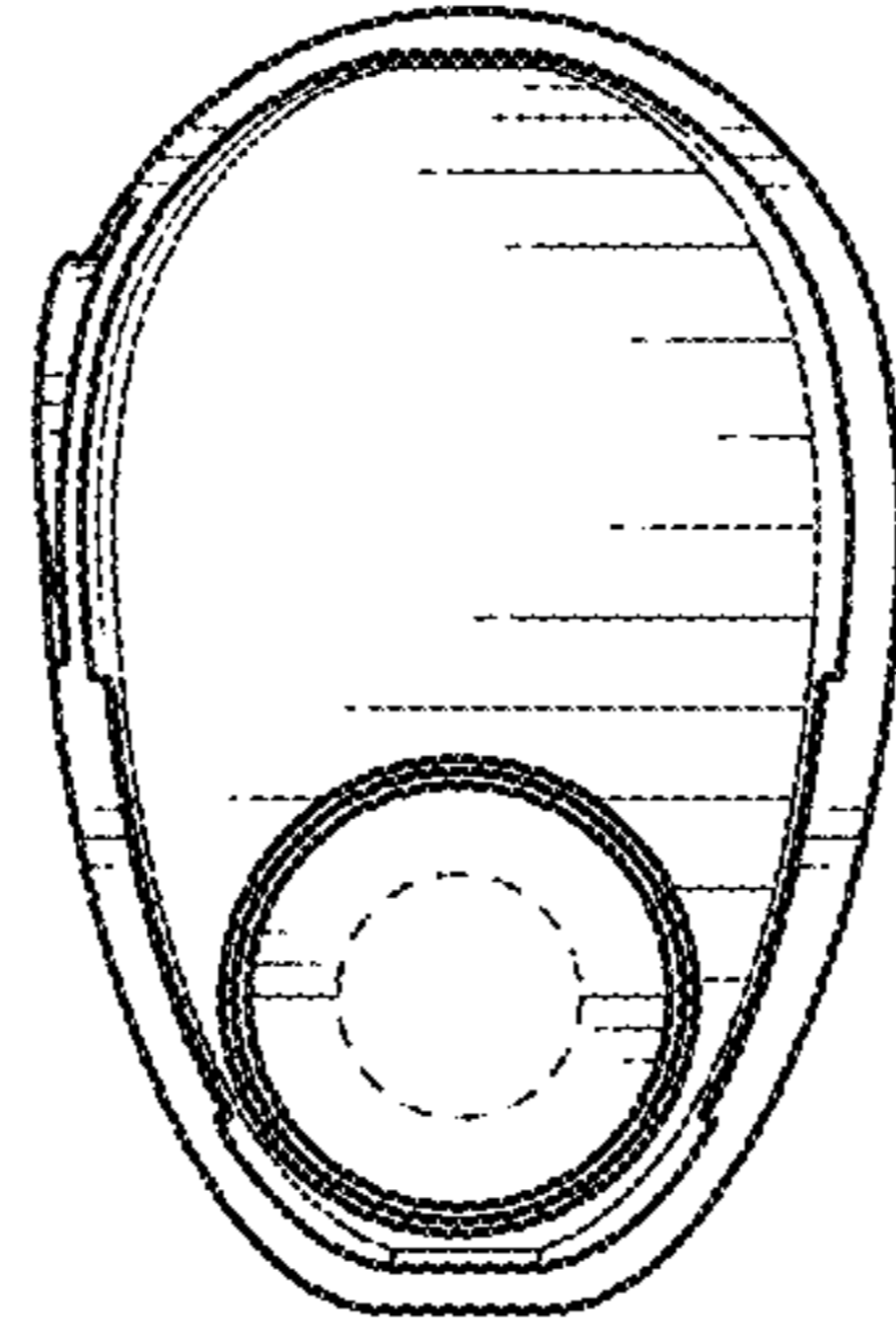

FIG. 5

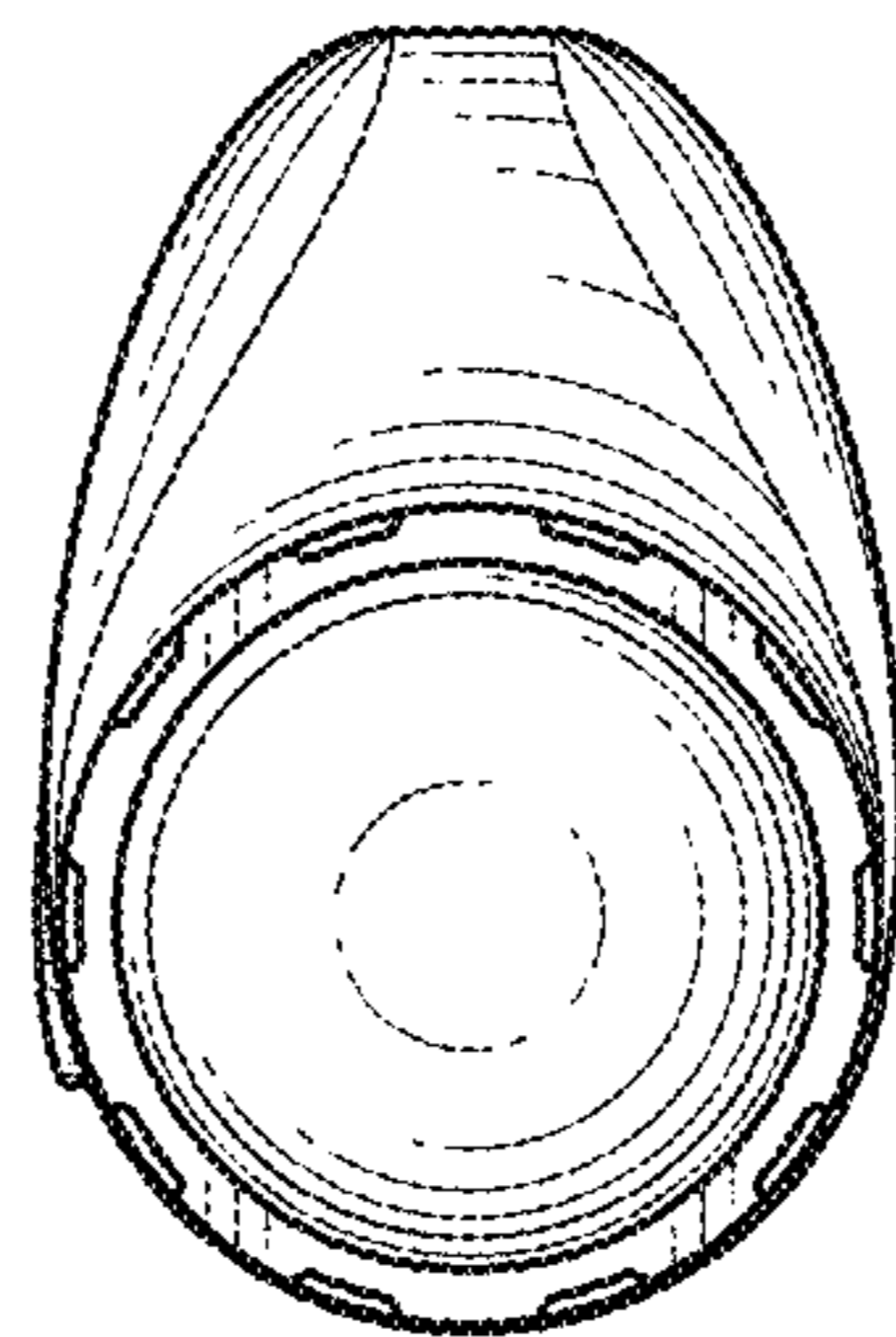

FIG. 6



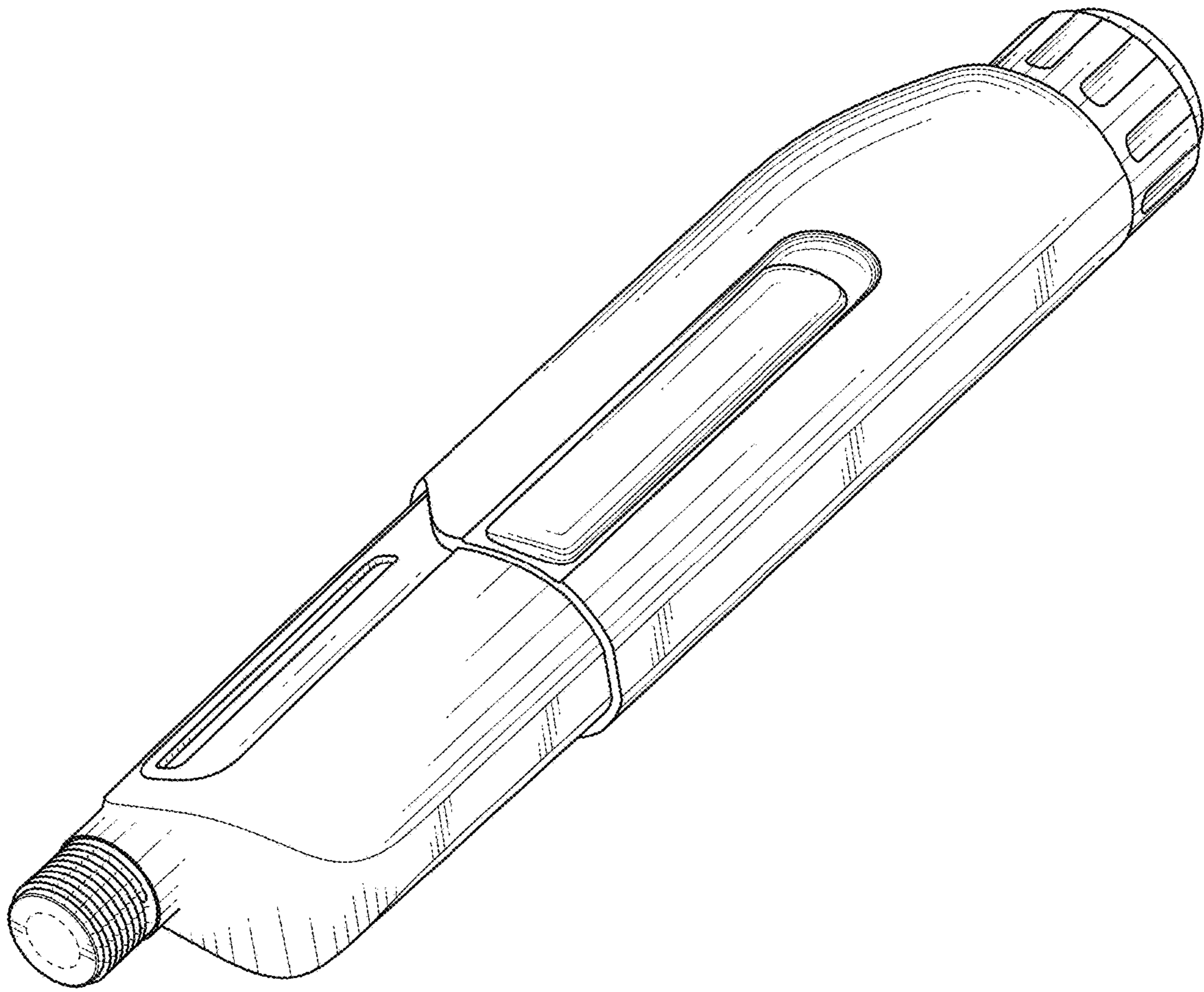

FIG. 7