



US00D802746S

(12) **United States Design Patent** (10) **Patent No.:** **US D802,746 S**
Ocklenburg et al. (45) **Date of Patent:** **** Nov. 14, 2017**

(54) **SNORKEL**

(71) Applicant: **AMEO Sports GmbH**, Starnberg (DE)

(72) Inventors: **Matthias Ocklenburg**, Darmstadt (DE);
Jan von Hofacker, Starnberg (DE);
Andreas Neugebauer, Starnberg (DE);
Reinhard Misterek, Dortmund (DE)

(73) Assignee: **AMEO Sports GmbH**, Starnberg (DE)

(**) Term: **15 Years**

(21) Appl. No.: **29/549,730**

(22) Filed: **Dec. 28, 2015**

(30) **Foreign Application Priority Data**

Jun. 29, 2015	(EP)	002728261-0001
Jun. 29, 2015	(EP)	002728261-0002
Jun. 29, 2015	(EP)	002728261-0003
Jun. 29, 2015	(EP)	002728261-0004
Jun. 29, 2015	(EP)	002728261-0005
Jun. 29, 2015	(EP)	002728261-0006
Jun. 29, 2015	(EP)	002728261-0007
Jun. 29, 2015	(EP)	002728261-0008
Jun. 29, 2015	(EP)	002728261-0009
Jun. 29, 2015	(EP)	002728261-0010
Jun. 29, 2015	(EP)	002728261-0011
Jun. 29, 2015	(EP)	002728261-0012
Jun. 29, 2015	(EP)	002728261-0013

(Continued)

(51) **LOC (10) Cl.** **29-02**

(52) **U.S. Cl.**
USPC **D24/110.5**

(58) **Field of Classification Search**
USPC D24/110, 110.1, 110.4, 110.5; D21/801,
D21/804

(Continued)

(56) **References Cited**

U.S. PATENT DOCUMENTS

46,902 A * 3/1865 Hawkins B63C 11/205
128/201.11
1,210,939 A * 1/1917 Hilgers B63C 11/205
128/201.11

(Continued)

FOREIGN PATENT DOCUMENTS

DE 102015122503 A1 * 6/2016 B63C 11/205

OTHER PUBLICATIONS

Franco, Michael. Review: A Snorkel that Makes You Feel Like Aquaman. New Atlas. Posted: May 12, 2016. <<http://newatlas.com/ameo-powerbreather/43291/>>.*

Primary Examiner — Barbara Fox
Assistant Examiner — Lilyana Bekic
(74) *Attorney, Agent, or Firm* — Bodner & O'Rourke, LLP; Gerald T. Bodner; Christian P. Bodner

(57) **CLAIM**

The ornamental design for a snorkel, as shown and described.

DESCRIPTION

FIG. 1 is a top, front perspective view of a snorkel showing our new design;
FIG. 2 is a front elevational view thereof;
FIG. 3 is a rear elevational view thereof;
FIG. 4 is a left elevational view thereof;
FIG. 5 is a right elevational view thereof;
FIG. 6 is a top plan view thereof; and,
FIG. 7 is a bottom plan view thereof.

(Continued)

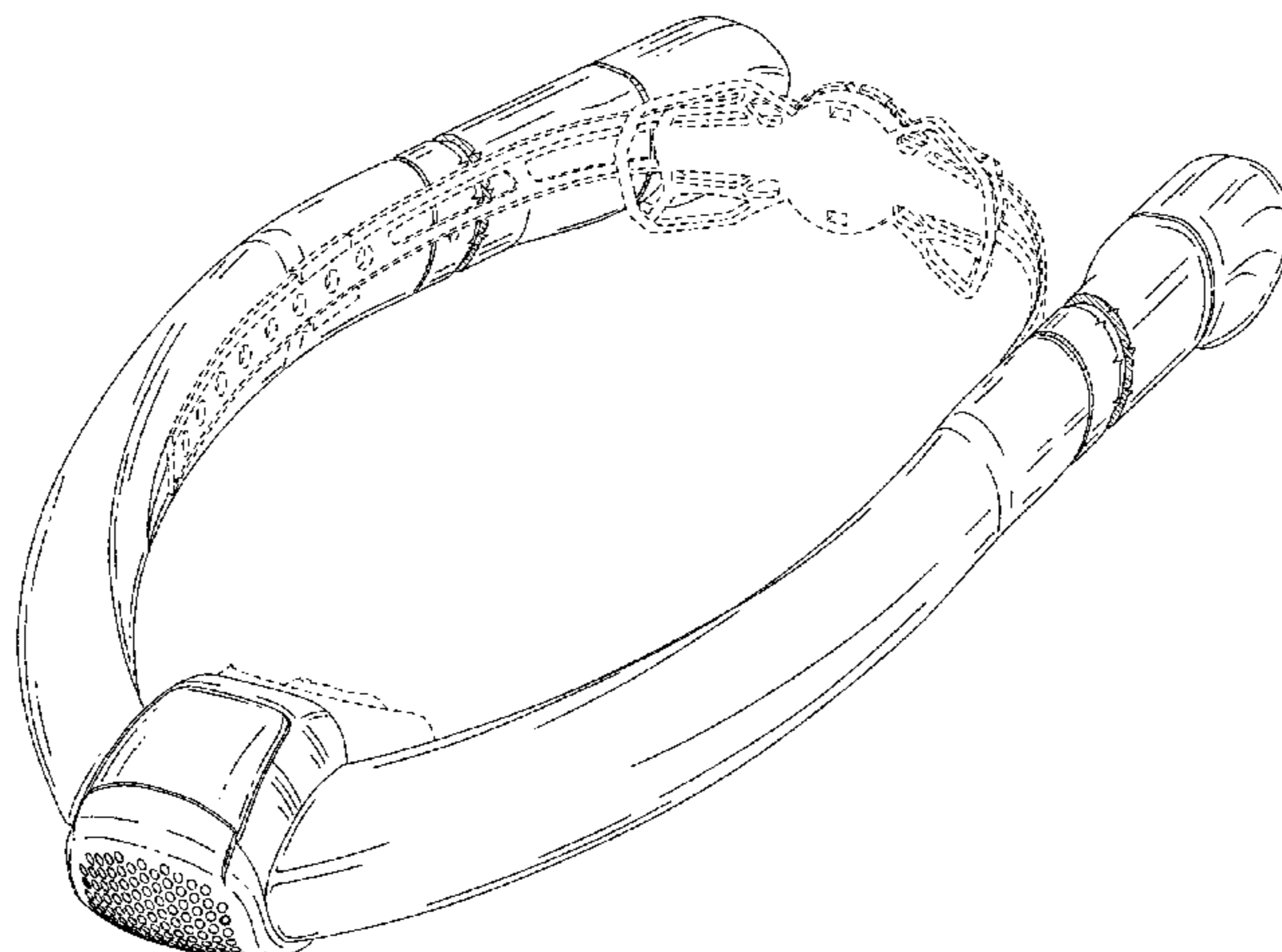

The broken lines in the drawings illustrate portions of the snorkel that form no part of the claimed design. The snorkel is shown with a symbolic break in its length. The appearance of any portion of the article between the break lines forms no part of the claimed invention.

1 Claim, 7 Drawing Sheets

(30) Foreign Application Priority Data

Jun. 29, 2015 (EP) 002728261-0014
 Jun. 29, 2015 (EP) 002728261-0015
 Jun. 29, 2015 (EP) 002728261-0016
 Jun. 29, 2015 (EP) 002728261-0017
 Jun. 29, 2015 (EP) 002728261-0018

(58) Field of Classification Search

CPC . B63C 11/205; B63C 2011/128; B63C 11/16;
 B63C 11/186; B63C 11/12; B63C
 2011/165

See application file for complete search history.

(56)

References Cited

U.S. PATENT DOCUMENTS

4,230,106	A *	10/1980	Geeslin	B63C 11/186 128/201.11
4,634,117	A *	1/1987	Kramer	A63B 23/18 128/201.26
4,878,491	A *	11/1989	McGilvray, III	B63C 11/205 128/201.11
5,485,832	A *	1/1996	Joffity	B63C 11/16 128/201.11
5,697,362	A *	12/1997	Albrecht	B63C 11/205 128/201.11
6,550,479	B1 *	4/2003	Duxbury	A62B 7/10 128/205.27
D501,044	S *	1/2005	Weigner	D24/110.5
2009/0038058	A1 *	2/2009	Carroll	A61F 9/028 2/436
2014/0331997	A1 *	11/2014	Weigner	B63C 11/205 128/201.11
2015/0239537	A1 *	8/2015	Calvillo	B63C 11/205 128/201.11

* cited by examiner

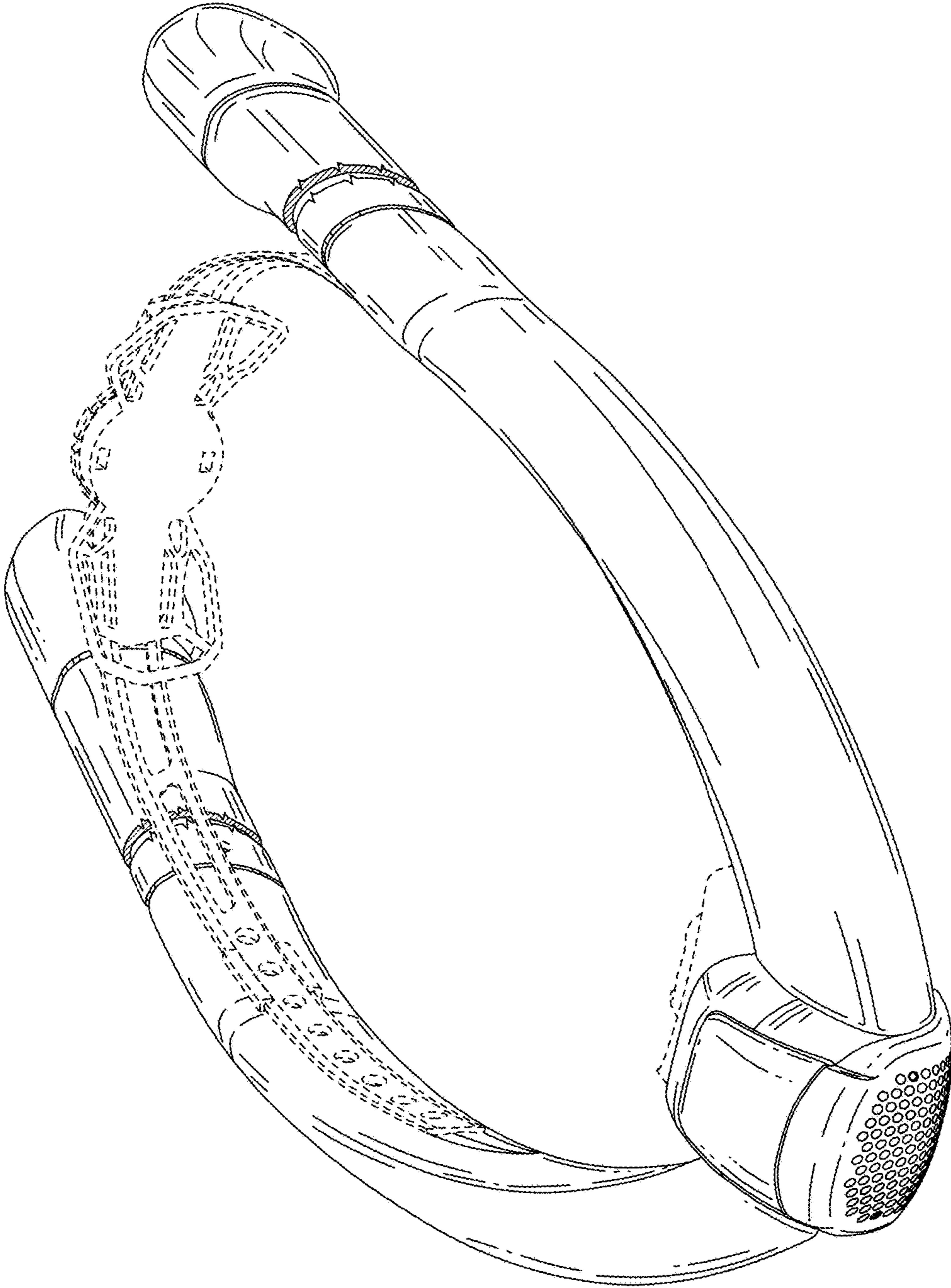

FIG. 1

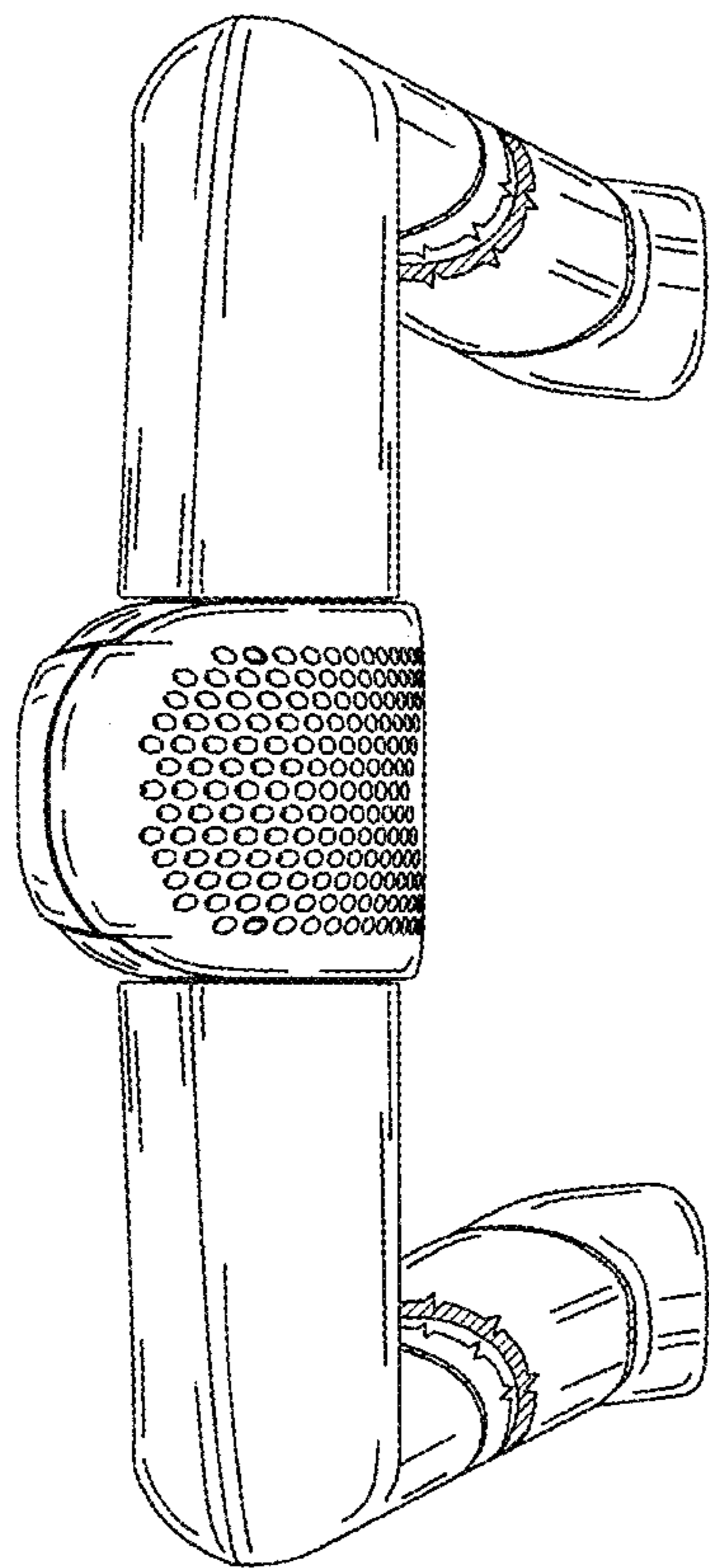

FIG. 2

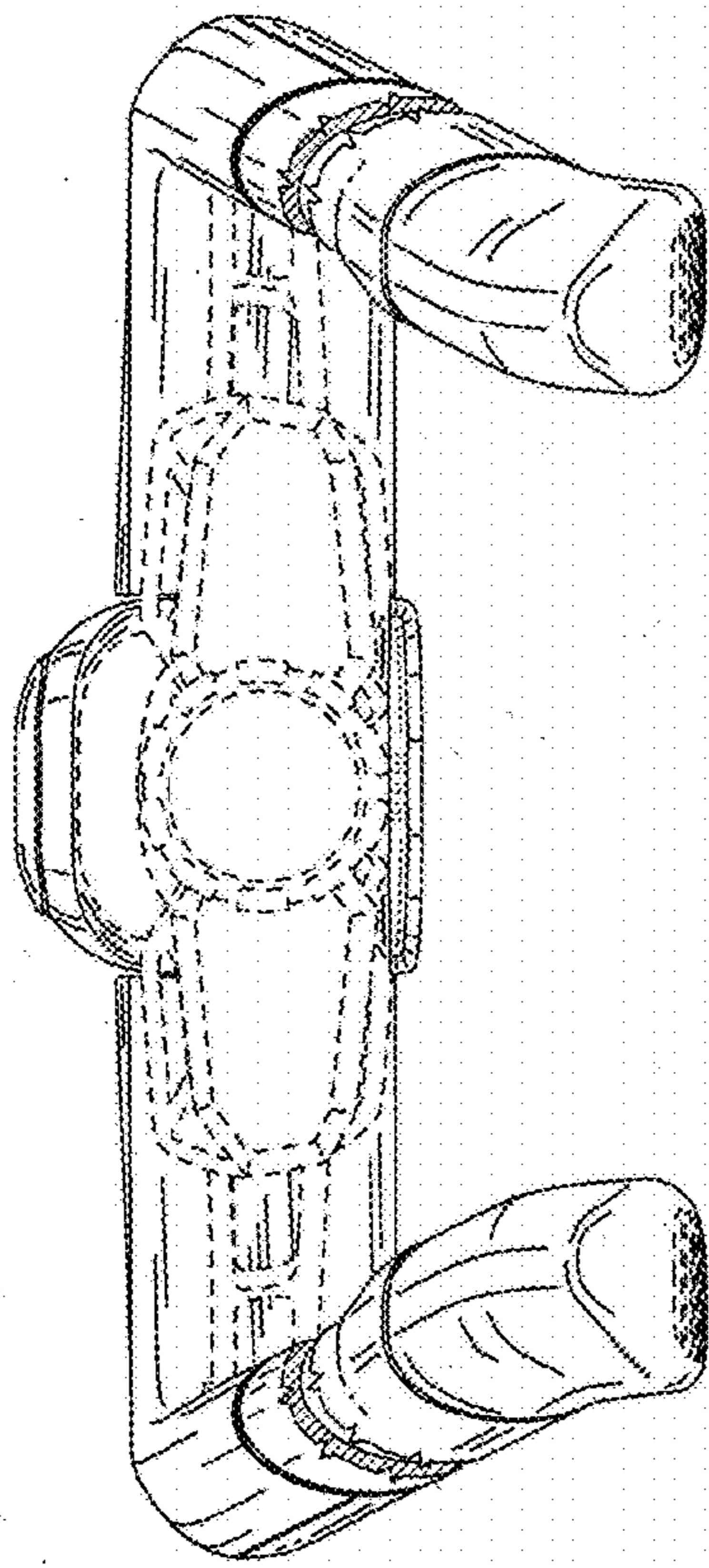

FIG. 3

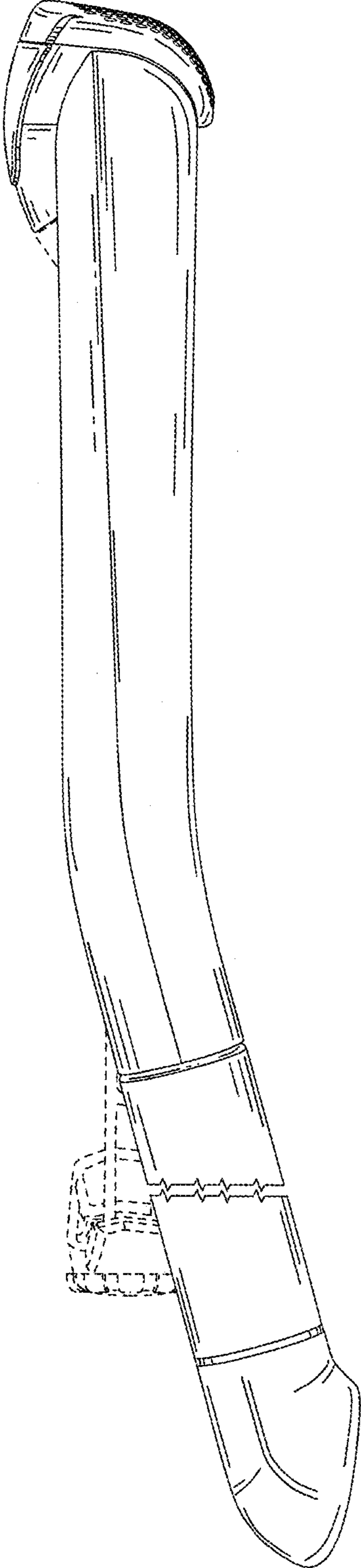

FIG. 4

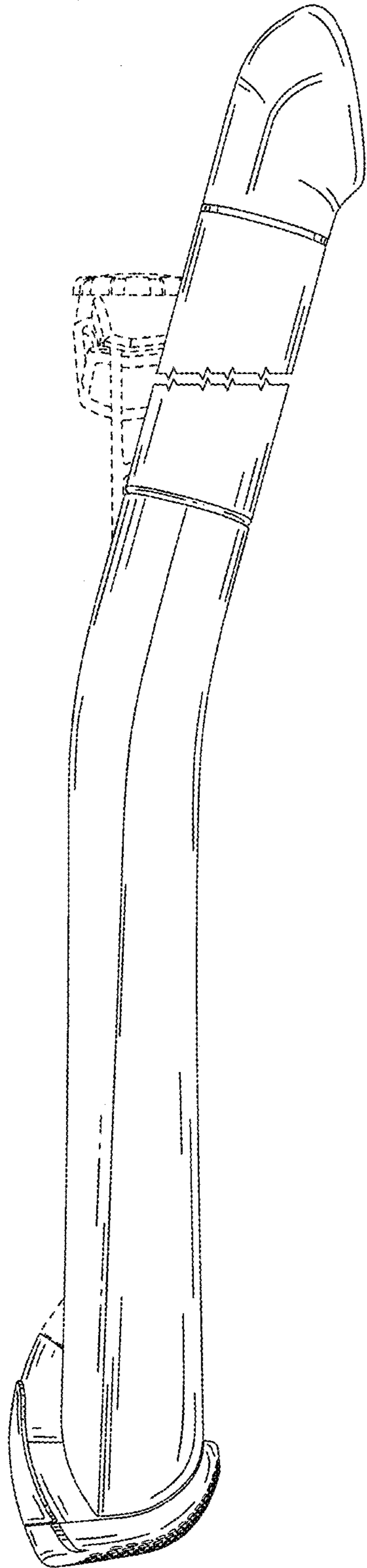

FIG. 5

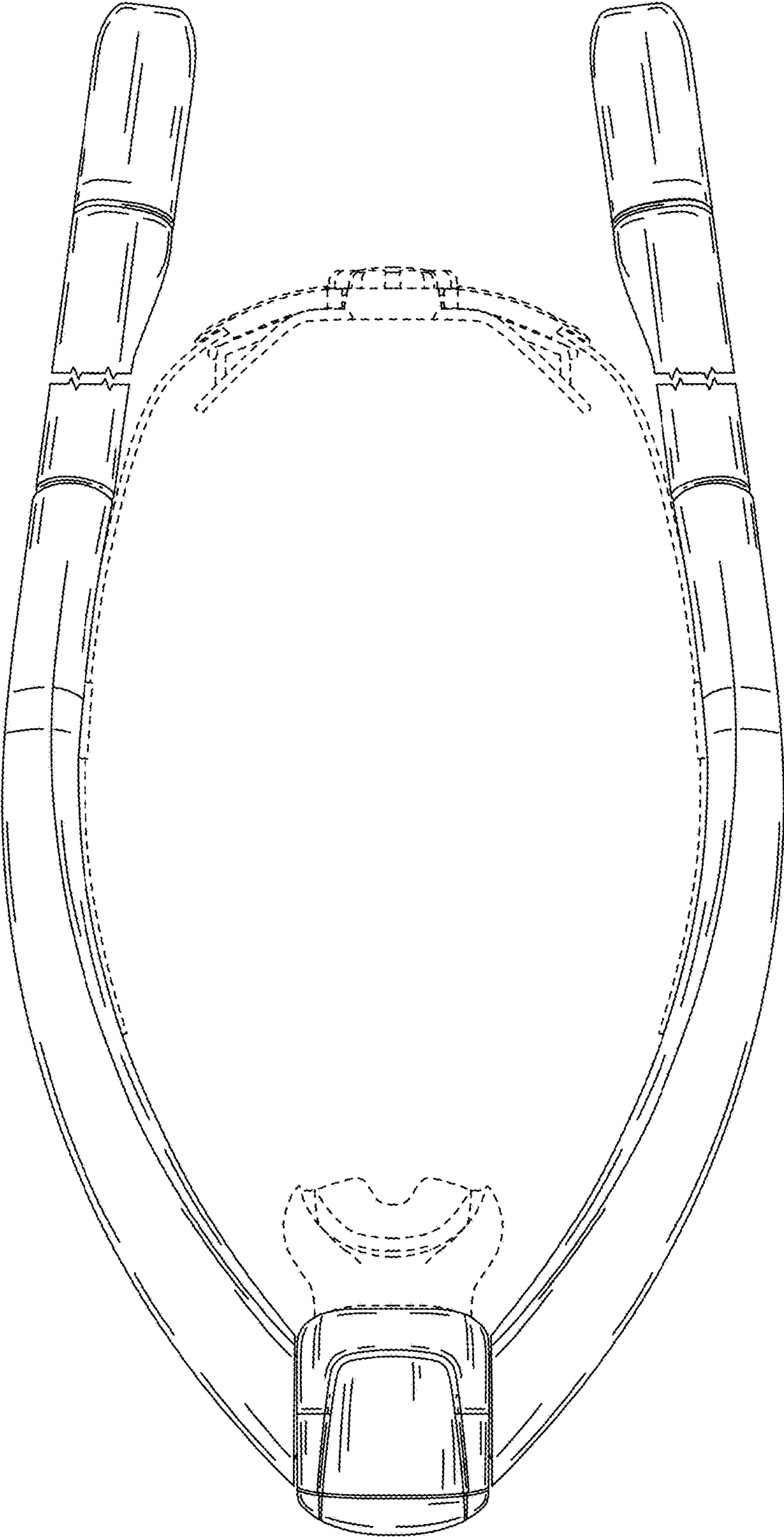

FIG. 6

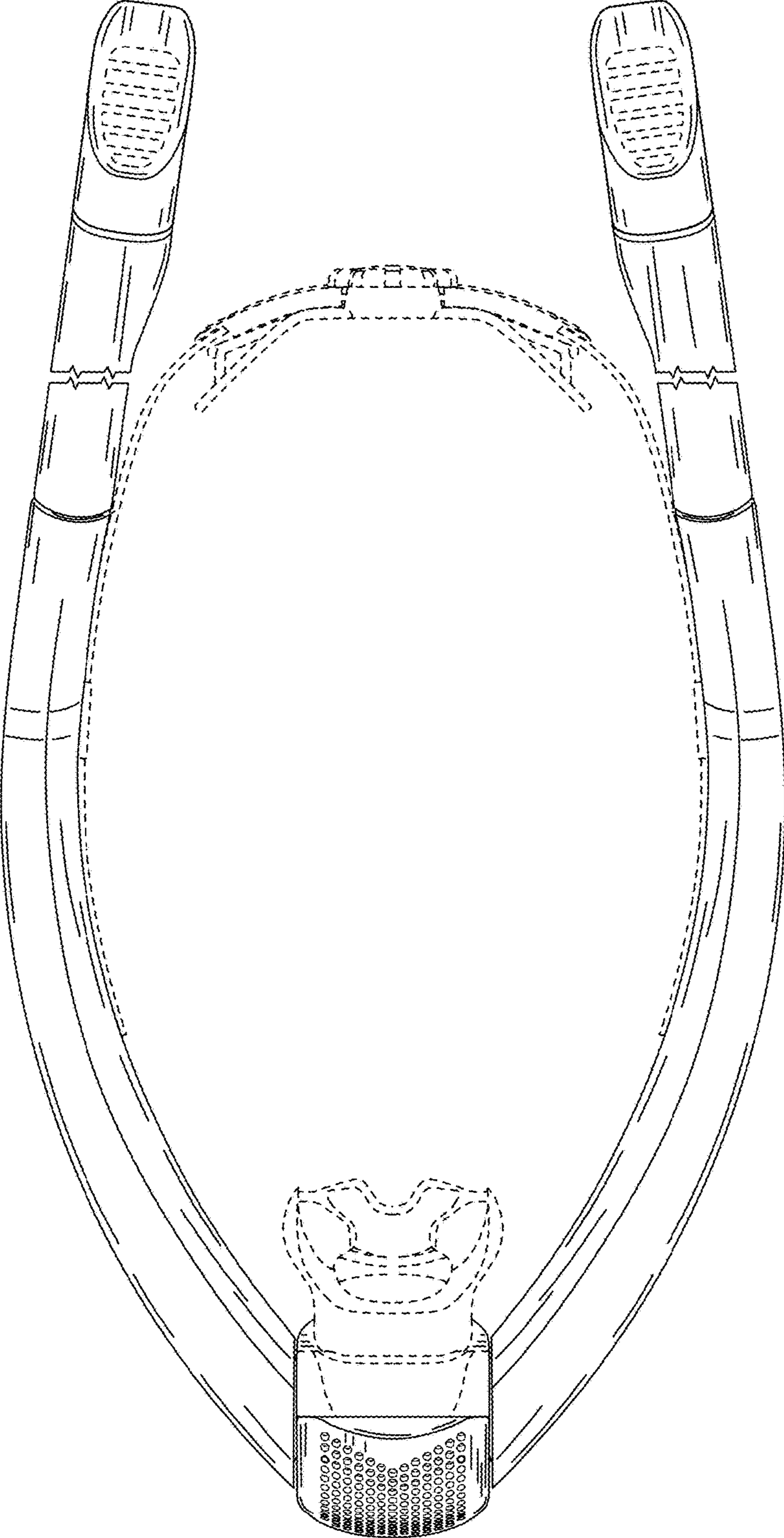

FIG. 7