



US00D802745S

(12) **United States Design Patent** (10) **Patent No.:** **US D802,745 S**  
**Ocklenburg et al.** (45) **Date of Patent:** **\*\* Nov. 14, 2017**

(54) **SNORKEL**

(71) Applicant: **AMEO Sports GmbH**, Starnberg (DE)

(72) Inventors: **Matthias Ocklenburg**, Darmstadt (DE);  
**Jan von Hofacker**, Starnberg (DE);  
**Andreas Neugebauer**, Starnberg (DE);  
**Reinhard Misterek**, Dortmund (DE)

(73) Assignee: **AMEO Sports GmbH**, Starnberg (DE)

(\*\*) Term: **15 Years**

(21) Appl. No.: **29/549,716**

(22) Filed: **Dec. 28, 2015**

(30) **Foreign Application Priority Data**

Jun. 29, 2015	(EP)	002728261-0001
Jun. 29, 2015	(EP)	002728261-0002
Jun. 29, 2015	(EP)	002728261-0003
Jun. 29, 2015	(EP)	002728261-0004
Jun. 29, 2015	(EP)	002728261-0005
Jun. 29, 2015	(EP)	002728261-0006
Jun. 29, 2015	(EP)	002728261-0007
Jun. 29, 2015	(EP)	002728261-0008
Jun. 29, 2015	(EP)	002728261-0009
Jun. 29, 2015	(EP)	002728261-0010
Jun. 29, 2015	(EP)	002728261-0011
Jun. 29, 2015	(EP)	002728261-0012
Jun. 29, 2015	(EP)	002728261-0013
Jun. 29, 2015	(EP)	002728261-0014

(Continued)

(51) **LOC (10) Cl.** ..... **29-02**

(52) **U.S. Cl.**  
USPC ..... **D24/110.5**

(58) **Field of Classification Search**

USPC ..... D24/110, 110.1, 110.4, 110.5; D21/801,  
D21/804

(Continued)

(56) **References Cited**

**U.S. PATENT DOCUMENTS**

46,902 A \* 3/1865 Hawkins ..... B63C 11/205  
128/201.11  
1,210,939 A \* 1/1917 Hilgers ..... B63C 11/205  
128/201.11

(Continued)

**FOREIGN PATENT DOCUMENTS**

DE 102015122503 A1 \* 6/2016 ..... B63C 11/205

**OTHER PUBLICATIONS**

Franco, Michael. Review: A Snorkel that Makes You Feel Like Aquaman. New Atlas. Posted: May 12, 2016. <<http://newatlas.com/ameo-powerbreather/43291/>>.\*

*Primary Examiner* — Barbara Fox

*Assistant Examiner* — Lilyana Bekic

(74) *Attorney, Agent, or Firm* — Bodner & O'Rourke, LLP; Gerald T. Bodner; Christian P. Bodner

(57) **CLAIM**

The ornamental design for a snorkel, as shown and described.

**DESCRIPTION**

FIG. 1 is a top, front perspective view of a snorkel showing our new design;  
FIG. 2 is a front elevational view thereof;  
FIG. 3 is a rear elevational view thereof;  
FIG. 4 is a left elevational view thereof;  
FIG. 5 is a right elevational view thereof;  
FIG. 6 is a top plan view thereof; and,  
FIG. 7 is a bottom plan view thereof.

(Continued)

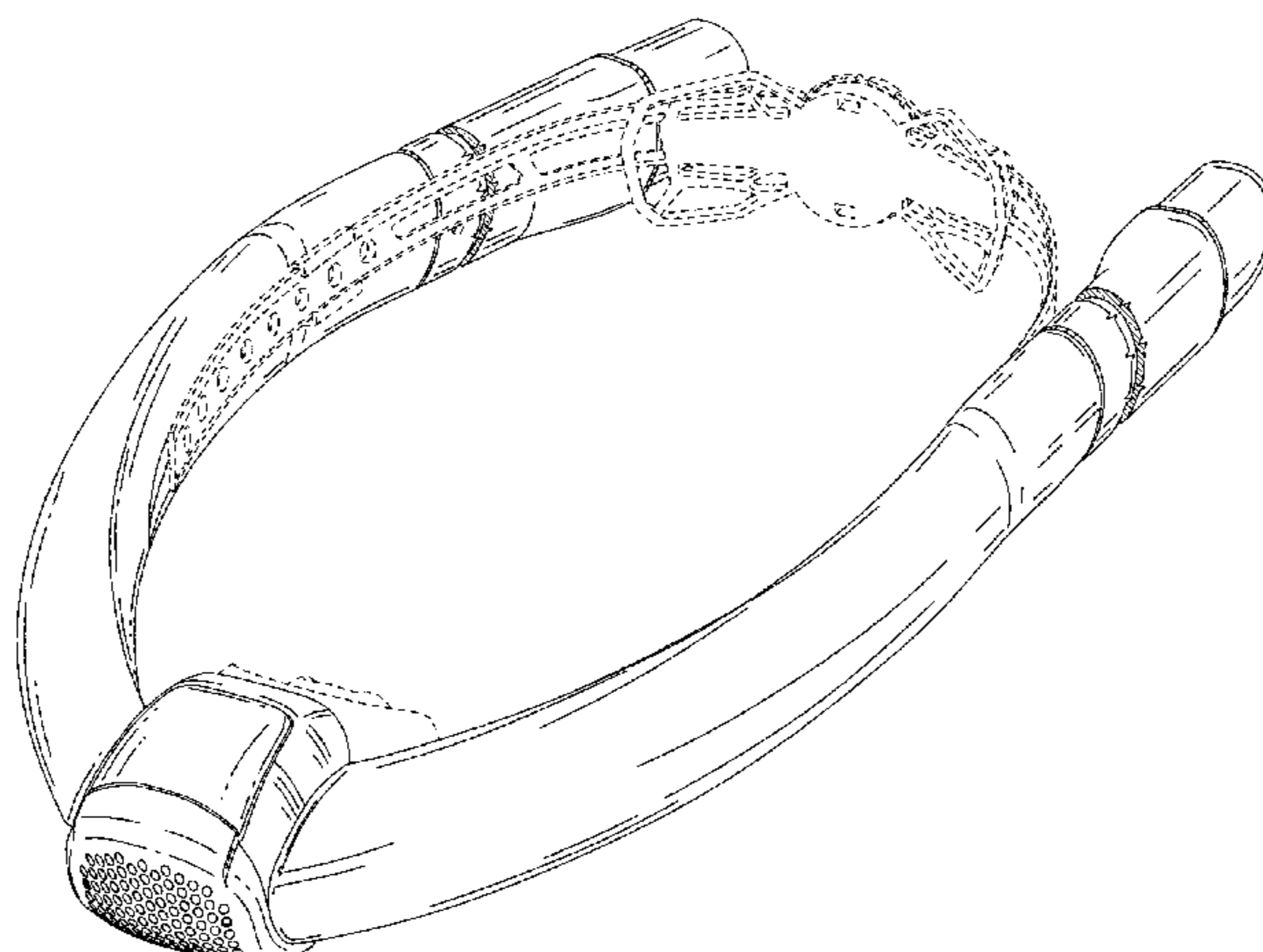

The broken lines in the drawings illustrate portions of the snorkel that form no part of the claimed design. The snorkel is shown with a symbolic break in its length. The appearance of any portion of the article between the break lines forms no part of the claimed invention.

**1 Claim, 7 Drawing Sheets**

(30) **Foreign Application Priority Data**

Jun. 29, 2015 (EP) ..... 002728261-0015  
Jun. 29, 2015 (EP) ..... 002728261-0016  
Jun. 29, 2015 (EP) ..... 002728261-0017  
Jun. 29, 2015 (EP) ..... 002728261-0018

(58) **Field of Classification Search**

CPC . B63C 11/205; B63C 2011/128; B63C 11/16;  
B63C 11/186; B63C 11/12; B63C  
2011/165

See application file for complete search history.

(56)

**References Cited**

U.S. PATENT DOCUMENTS

4,230,106 A \* 10/1980 Geeslin ..... B63C 11/186  
128/201.11  
4,634,117 A \* 1/1987 Kramer ..... A63B 23/18  
128/201.26  
4,878,491 A \* 11/1989 McGilvray, III ..... B63C 11/205  
128/201.11  
5,485,832 A \* 1/1996 Joffity ..... B63C 11/16  
128/201.11  
5,697,362 A \* 12/1997 Albrecht ..... B63C 11/205  
128/201.11  
6,550,479 B1 \* 4/2003 Duxbury ..... A62B 7/10  
128/205.27  
D501,044 S \* 1/2005 Weigner ..... D24/110.5  
2009/0038058 A1 \* 2/2009 Carroll ..... A61F 9/028  
2/436  
2014/0331997 A1 \* 11/2014 Weigner ..... B63C 11/205  
128/201.11  
2015/0239537 A1 \* 8/2015 Calvillo ..... B63C 11/205  
128/201.11

\* cited by examiner

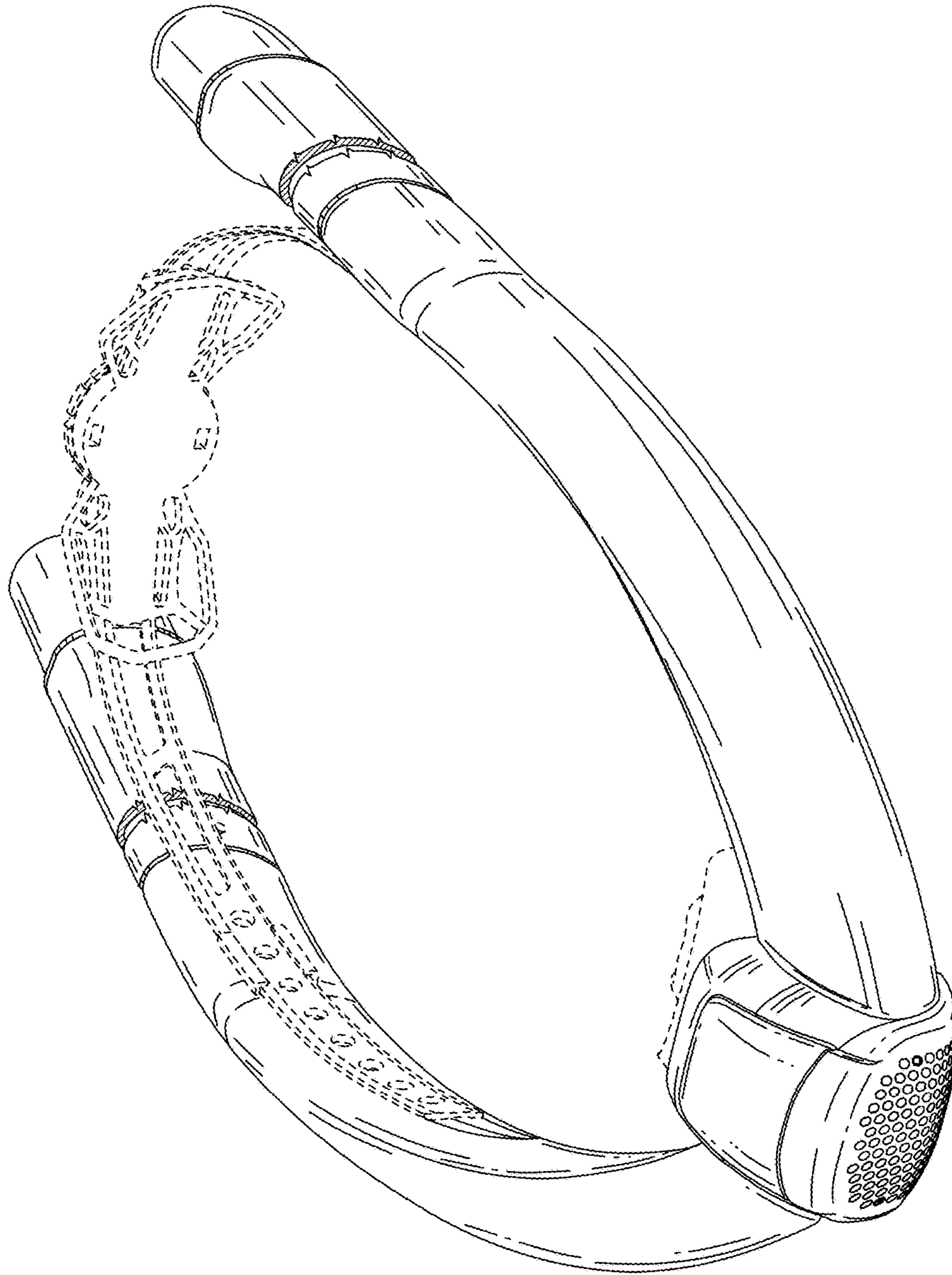

FIG. 1

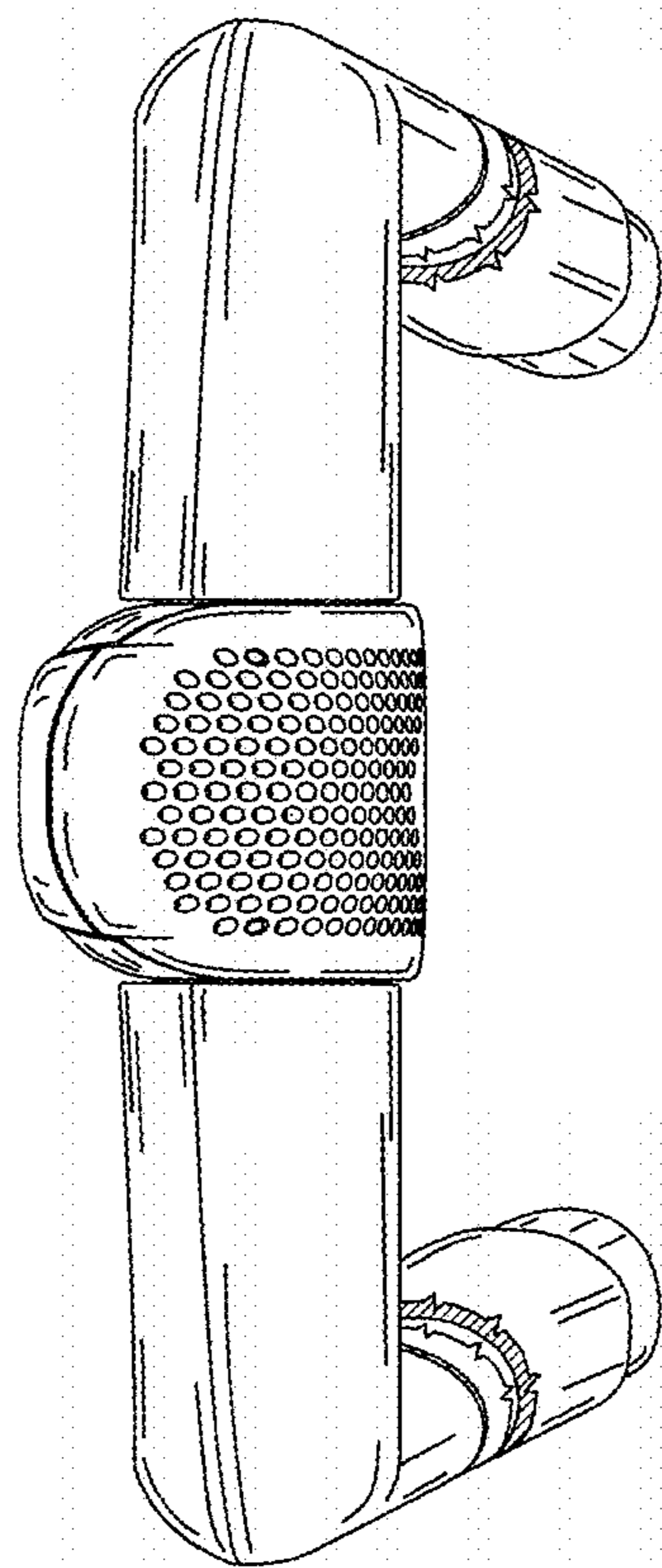

FIG. 2



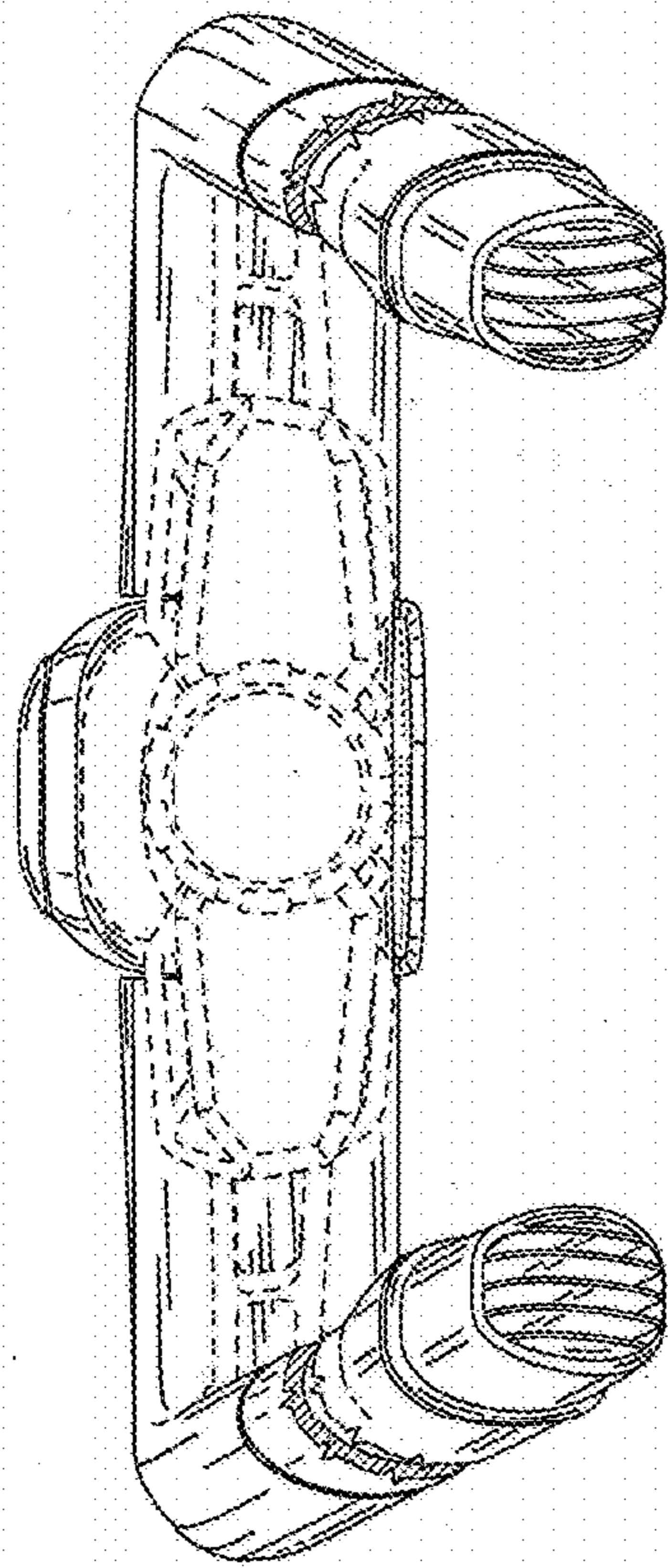

FIG. 3

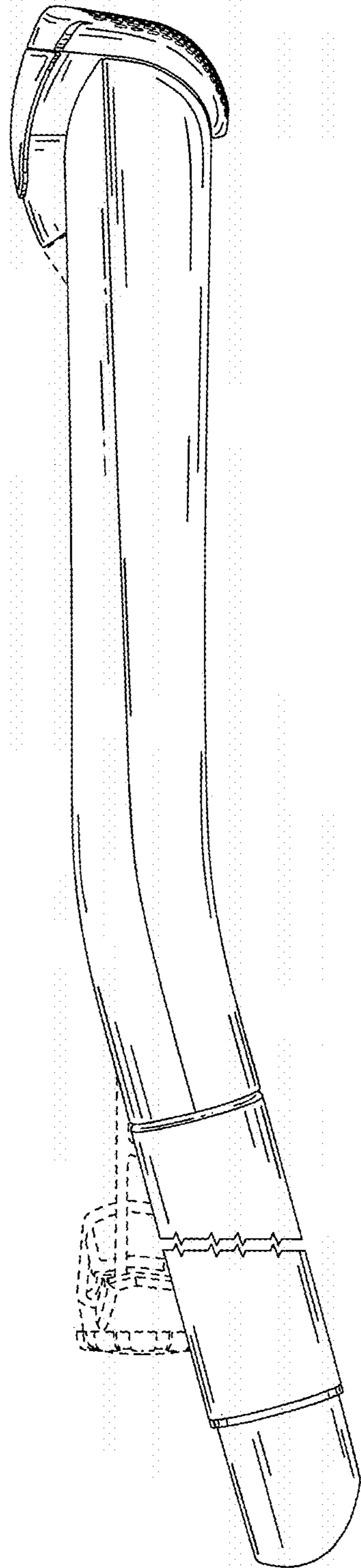

FIG. 4

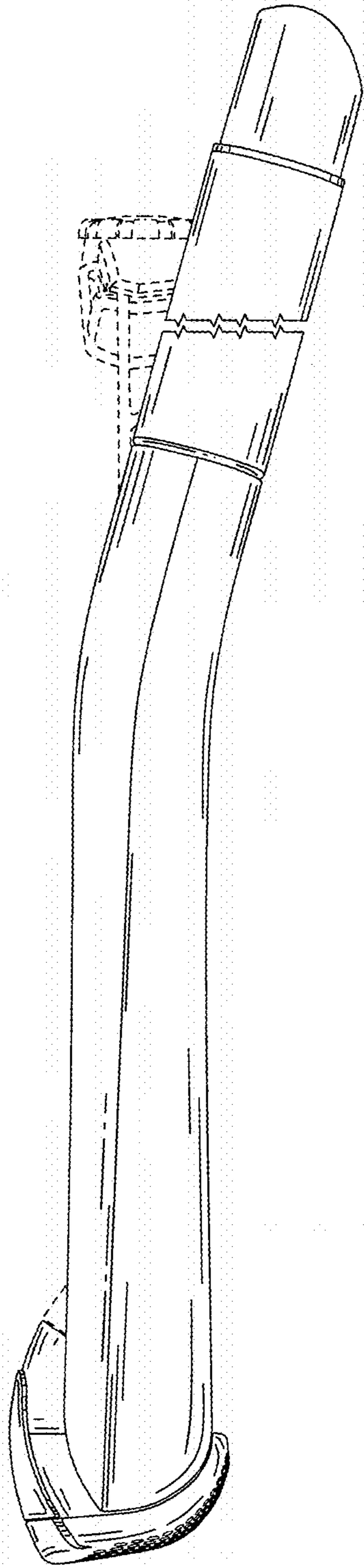

FIG. 5

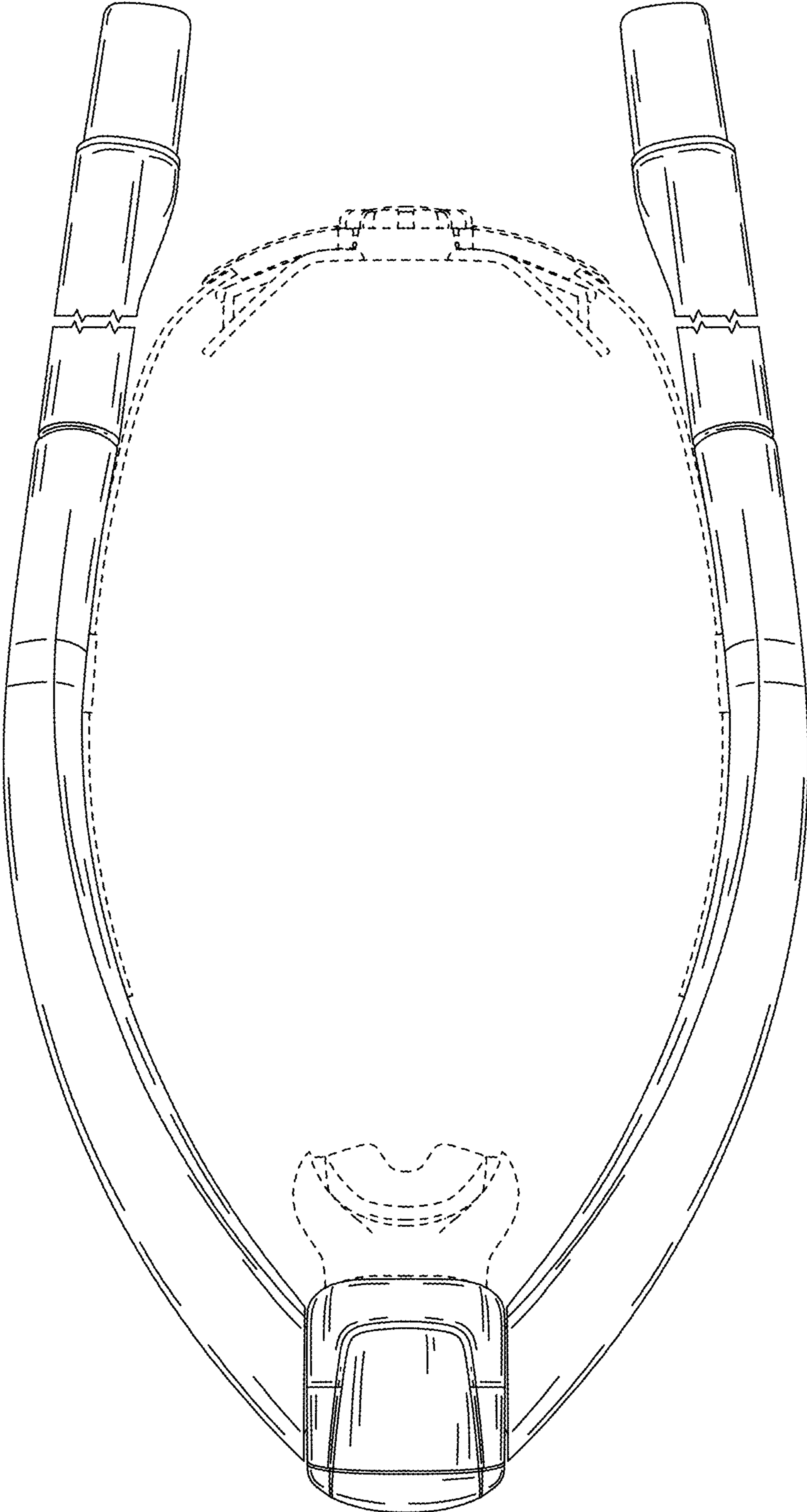

FIG. 6



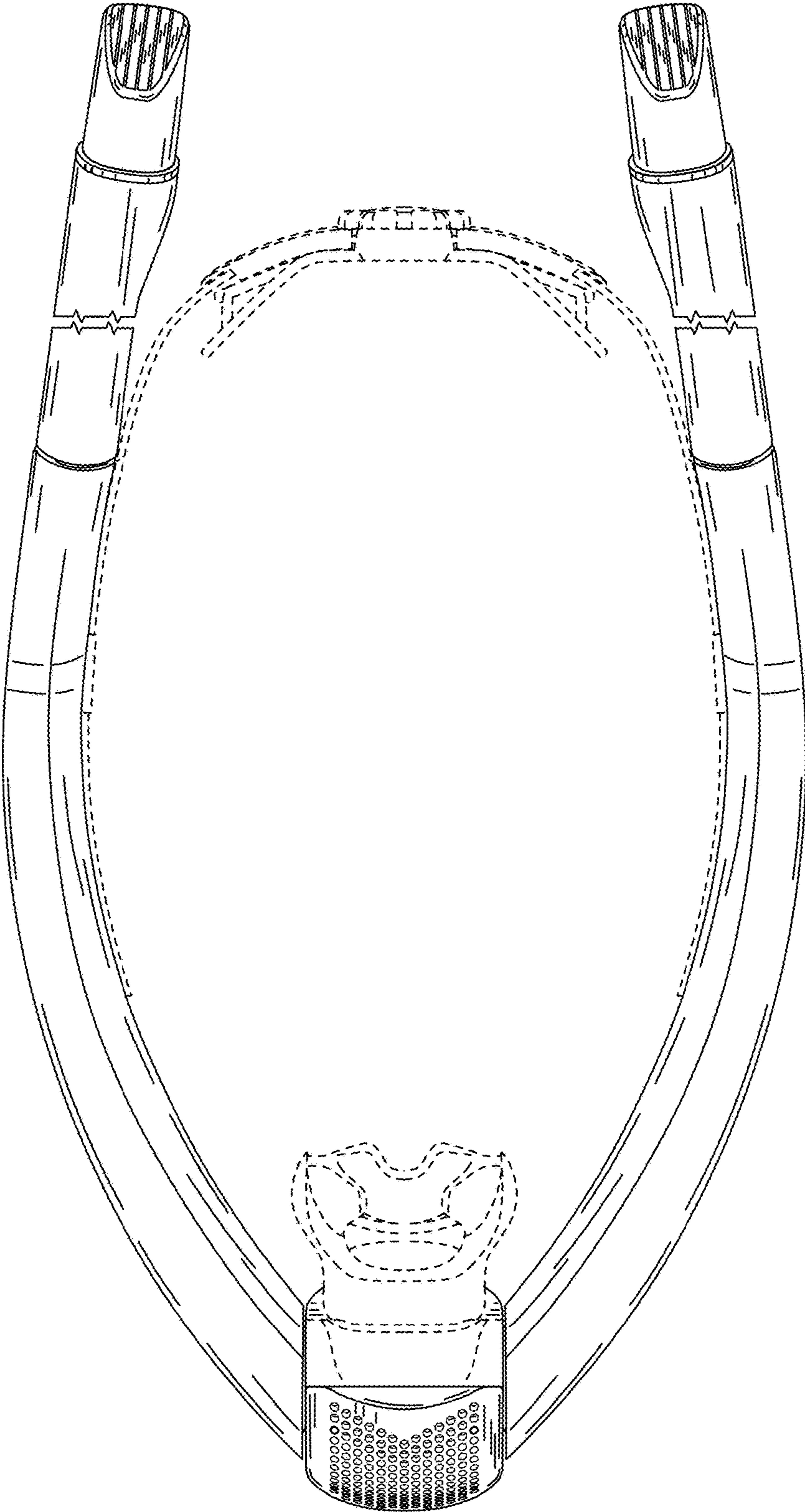

FIG. 7