



US00D802740S

(12) **United States Design Patent** (10) **Patent No.:** **US D802,740 S**
Kim et al. (45) **Date of Patent:** **** Nov. 14, 2017**

(54) **HUMIDIFYING FAN**

(56) **References Cited**

(71) Applicant: **LG ELECTRONICS INC.**, Seoul (KR)

U.S. PATENT DOCUMENTS

(72) Inventors: **Joosang Kim**, Seoul (KR); **Sungkyong Han**, Seoul (KR); **Yunseo Jang**, Seoul (KR); **Sehwan Bae**, Seoul (KR)

D514,688 S *	2/2006	Avedon	D23/379
D654,761 S *	2/2012	Herbst	D11/146
D659,257 S *	5/2012	Desberg	D24/232
D670,985 S *	11/2012	Tompkin	D26/49
D678,493 S *	3/2013	Lacotta	D23/355
D696,765 S *	12/2013	Spoerl	D23/378
D699,336 S *	2/2014	Girard	D23/370
D714,923 S *	10/2014	Engelhard	D23/364
D744,630 S *	12/2015	Ying	D23/378

(73) Assignee: **LG ELECTRONICS INC.**, Seoul (KR)

(**) Term: **15 Years**

* cited by examiner

(21) Appl. No.: **35/501,544**

Primary Examiner — Michael A Pratt

(22) Filed: **Mar. 11, 2016**

(74) *Attorney, Agent, or Firm* — Birch, Stewart, Kolasch & Birch, LLP

(80) **Hague Agreement Data**

Int. Filing Date: **Mar. 11, 2016**
Int. Reg. No.: **DM/089923**
Int. Reg. Date: **Mar. 11, 2016**
Int. Reg. Pub. Date: **Sep. 16, 2016**

(57) **CLAIM**

The ornamental design for a humidifying fan, as shown and described.

(30) **Foreign Application Priority Data**

Dec. 11, 2015 (KR) 30-2015-0063486

(51) **LOC (10) Cl.** **23-04**

(52) **U.S. Cl.**
USPC **D23/378**

(58) **Field of Classification Search**
USPC D23/378, 379, 380, 381, 382, 383
CPC F04D 25/00; F04D 25/10; F04D 25/08;
F04D 25/105; F04D 25/166; F04D 17/04
See application file for complete search history.

DESCRIPTION

1. Humidifying fan
- 1.1 is a perspective view
- 1.2 is a front side view
- 1.3 is rear side view
- 1.4 is a left view
- 1.5 is a right view
- 1.6 is a top view
- 1.7 is a bottom view
- 1.8 is shown in an alternate position.
- 1.9 is shown in an alternate position.

1 Claim, 9 Drawing Sheets

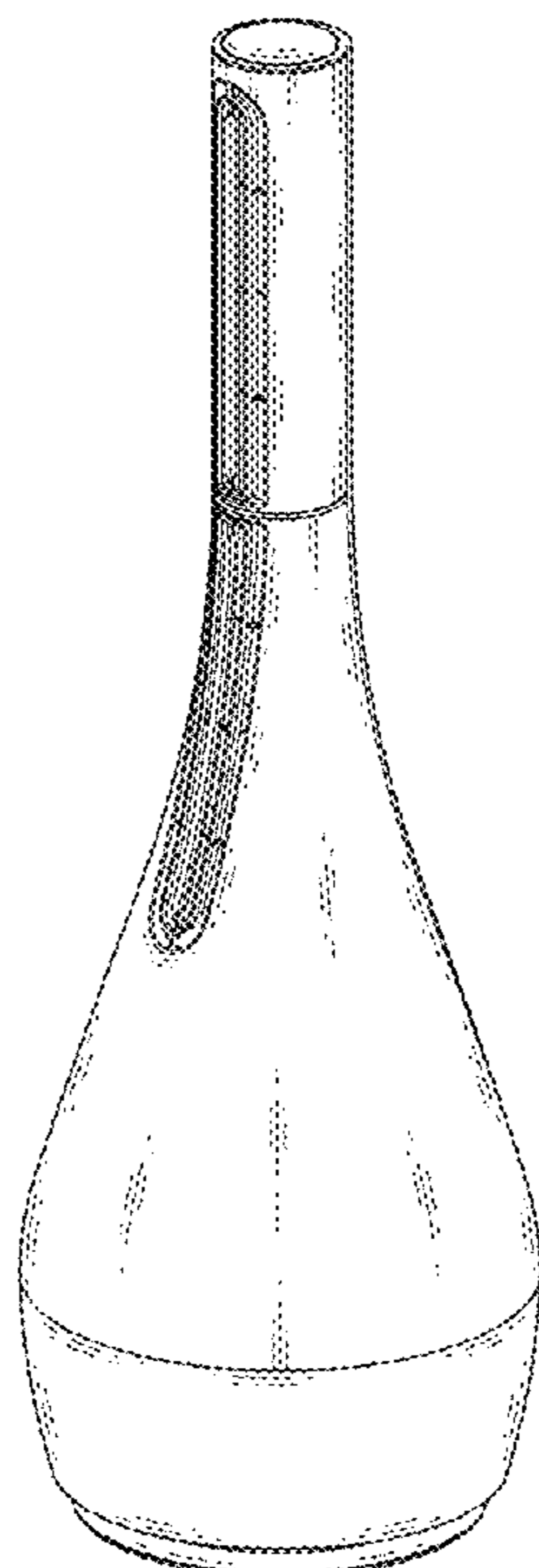

1.1

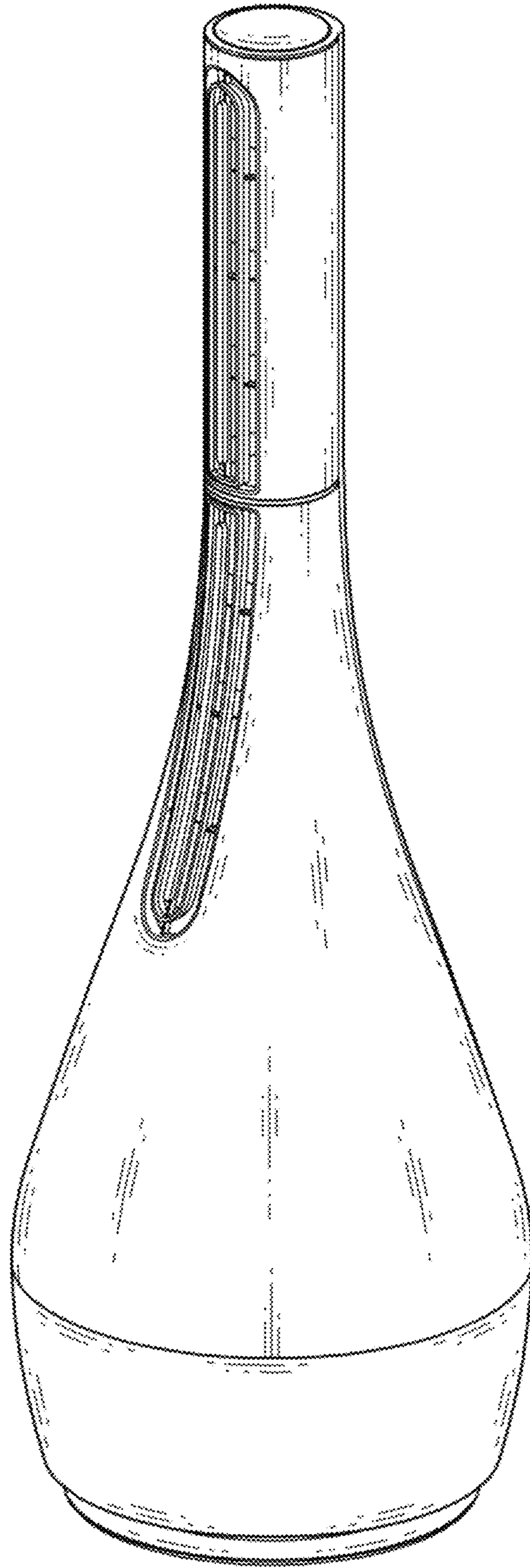

1.2

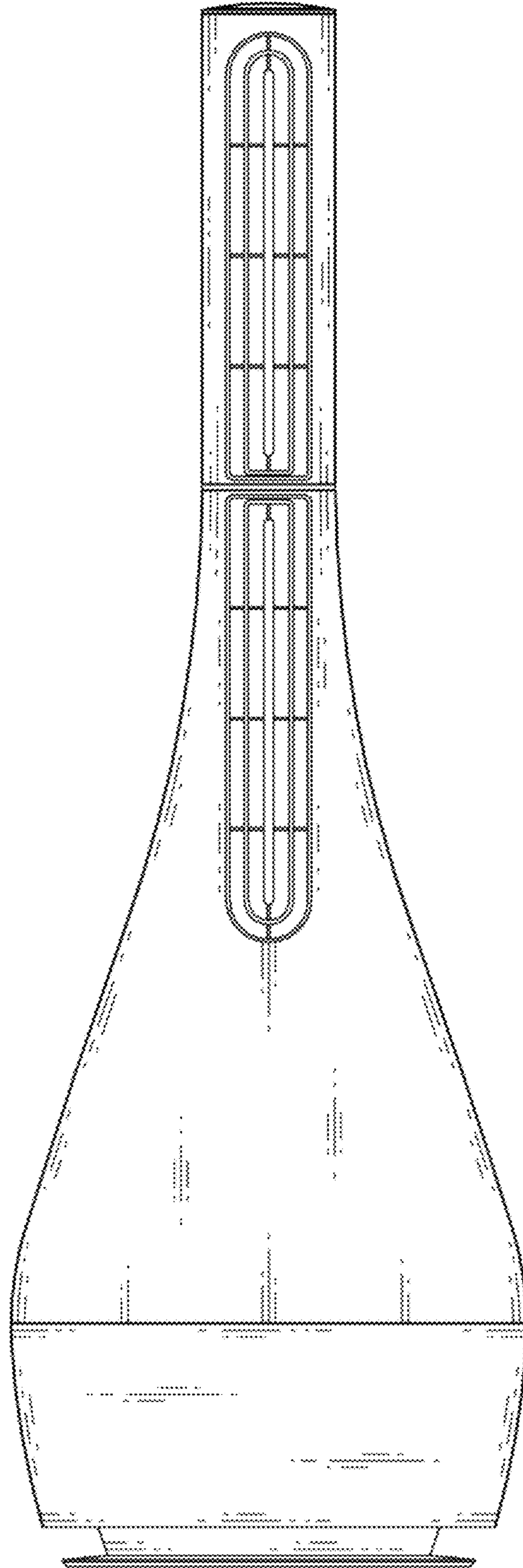

1.3

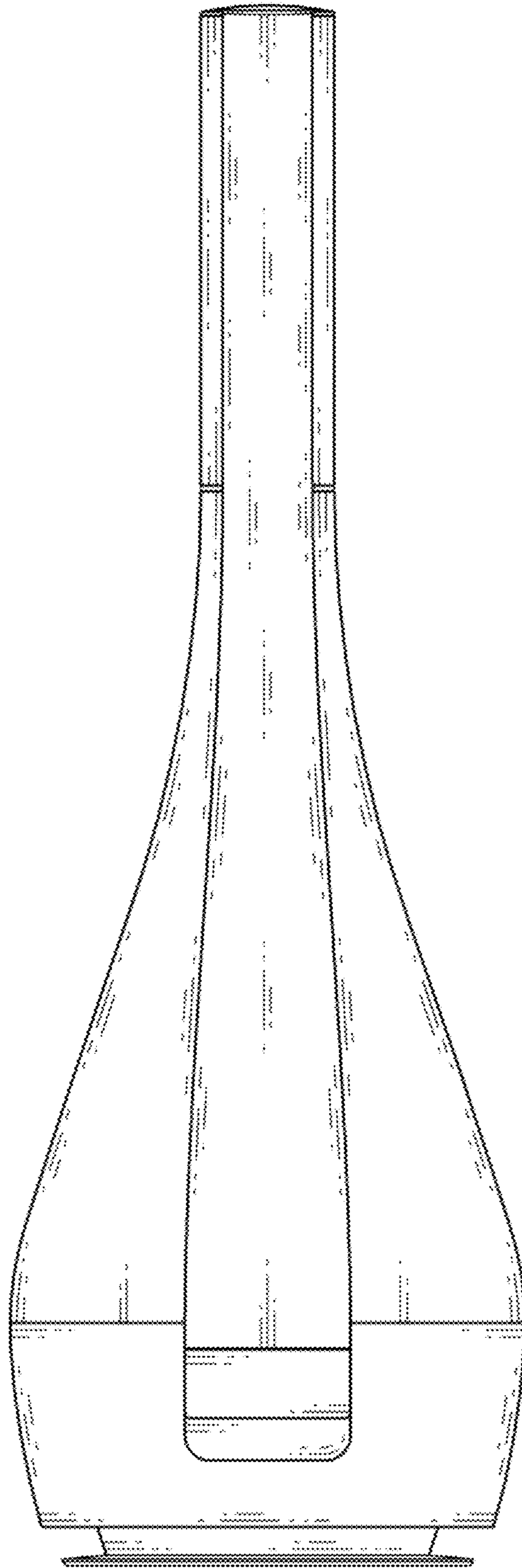

1.4

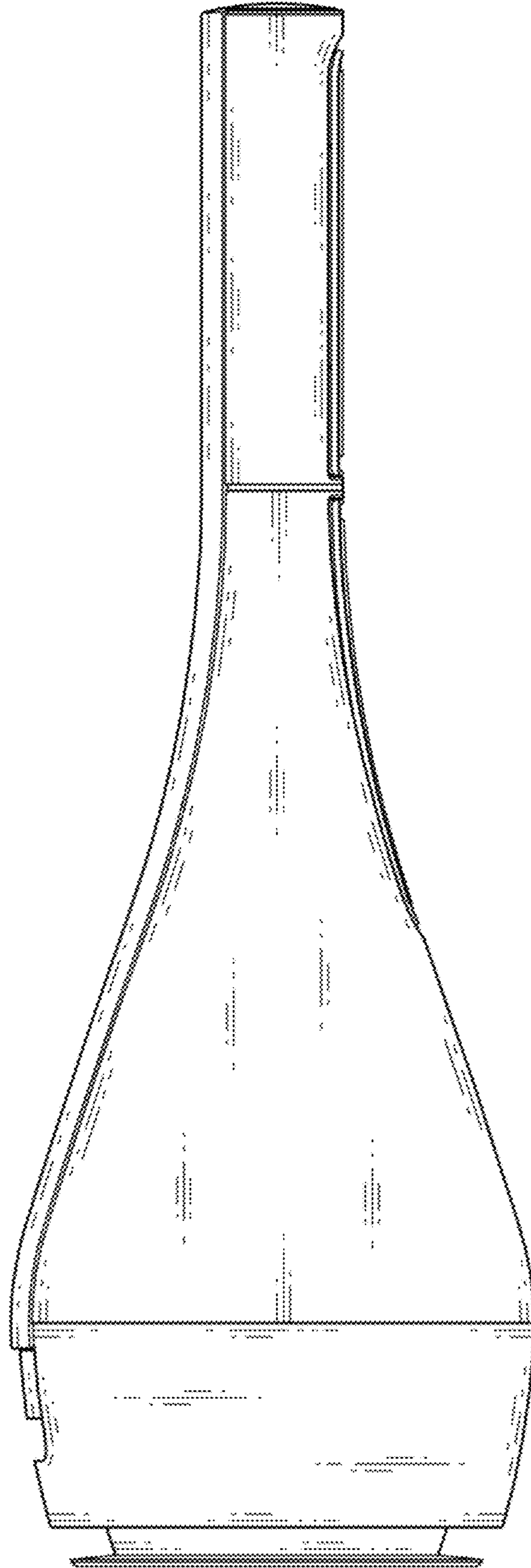

1.5

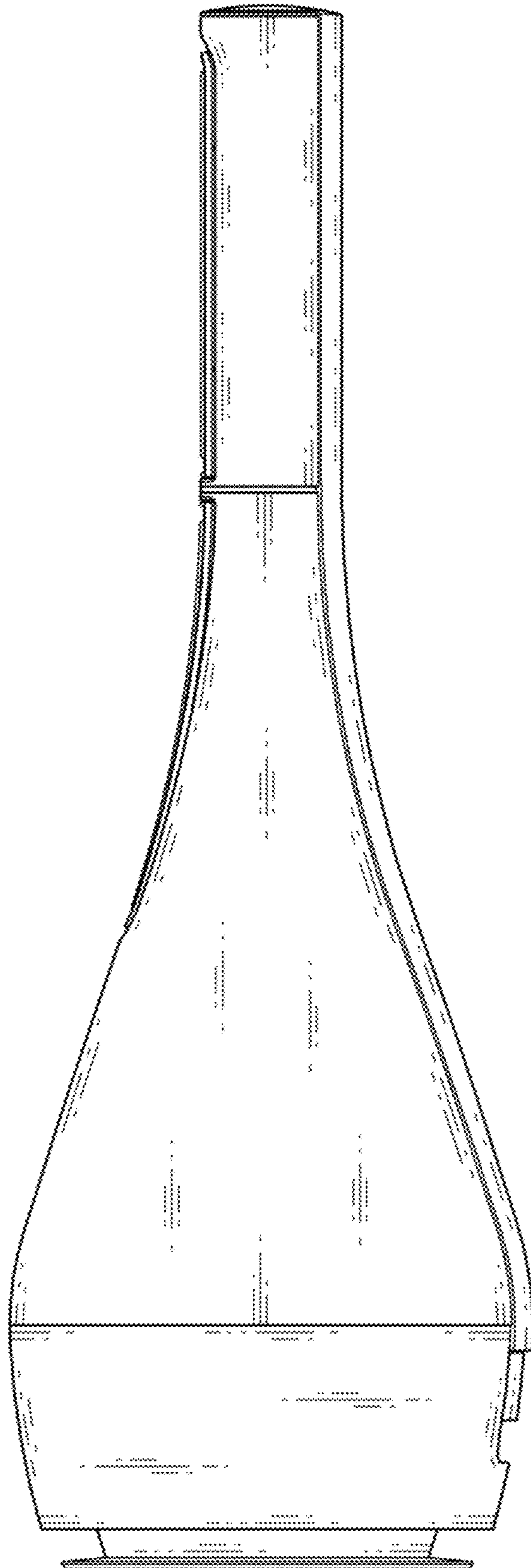

1.6

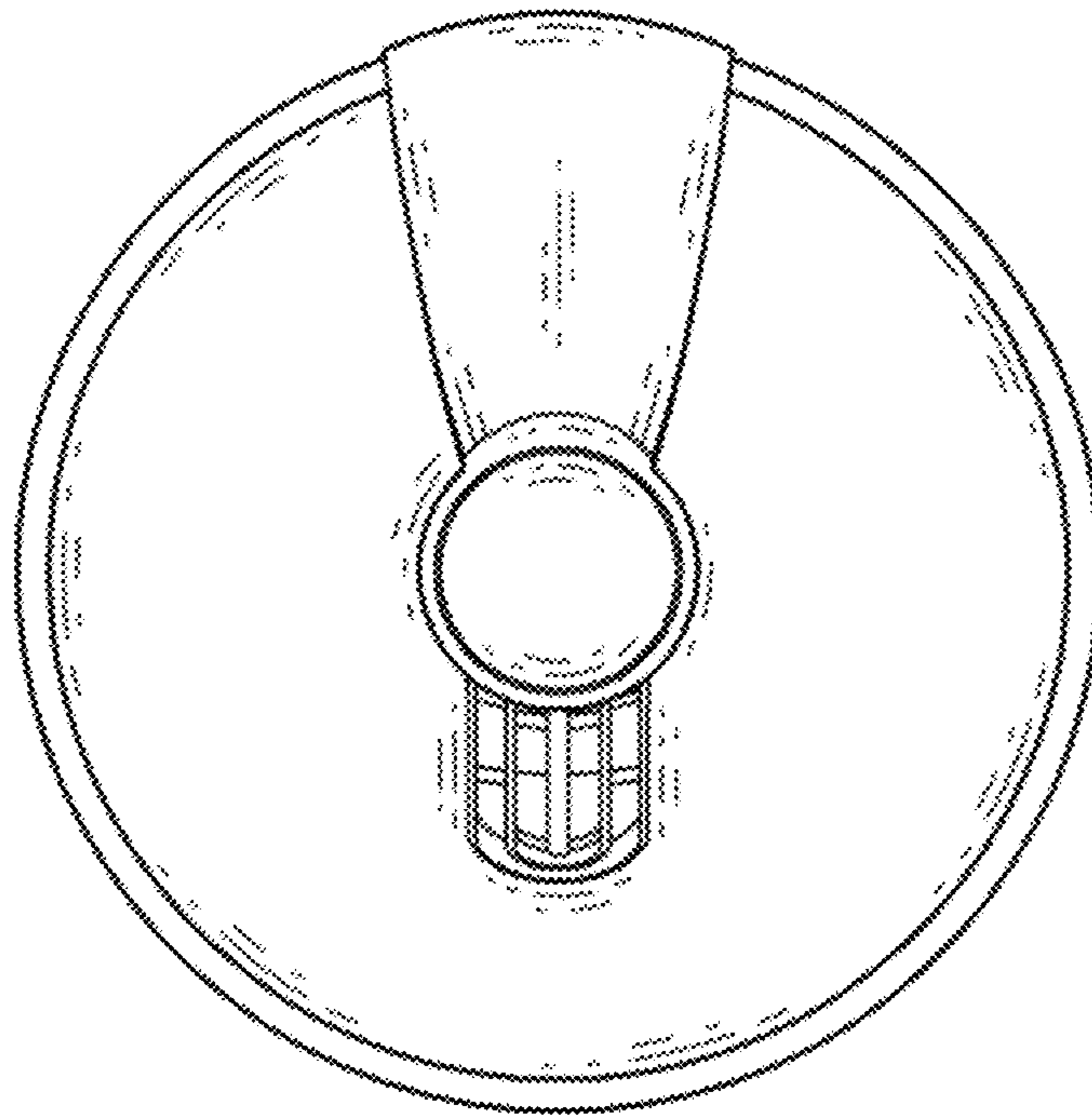

1.7

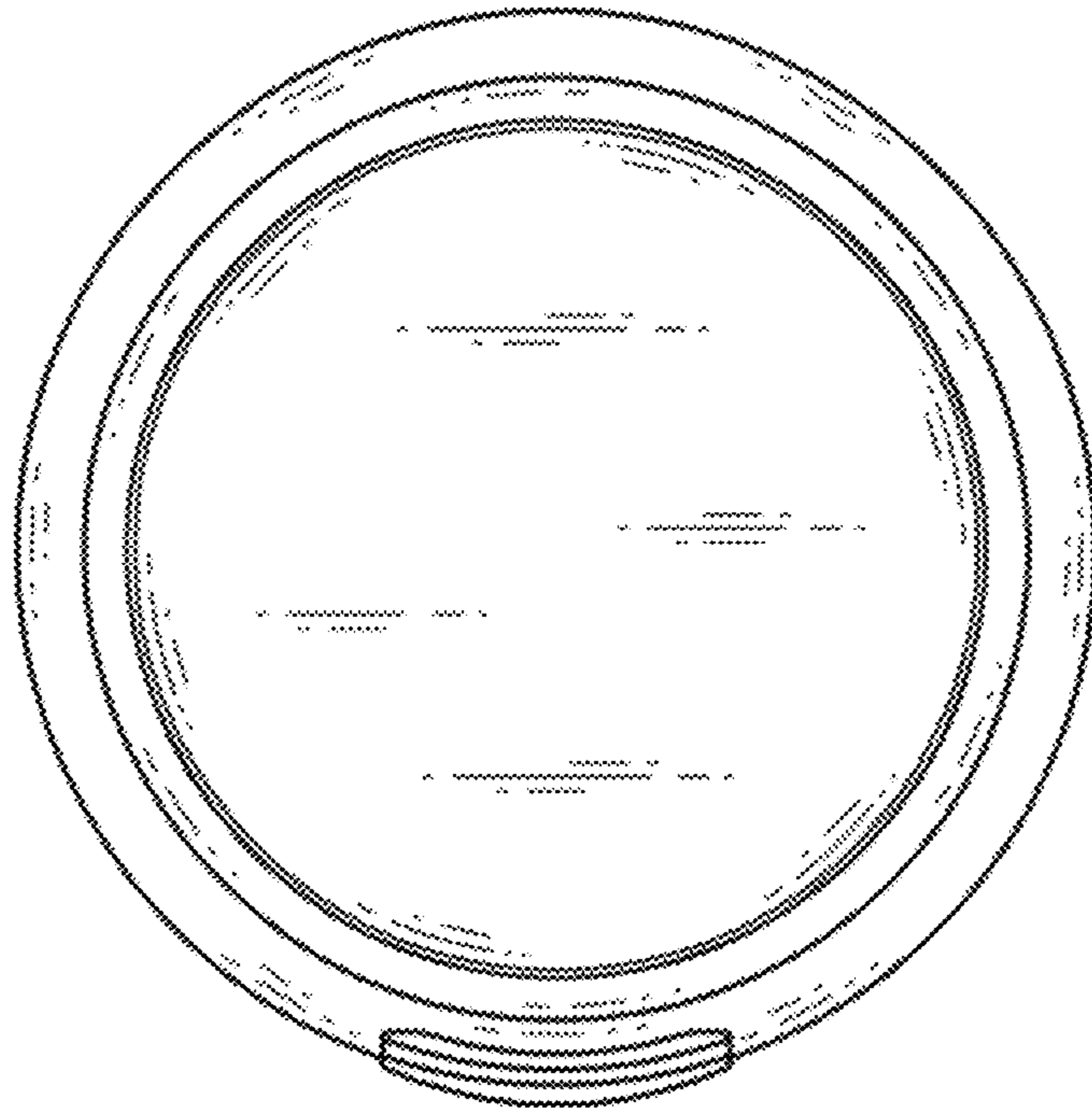

1.8

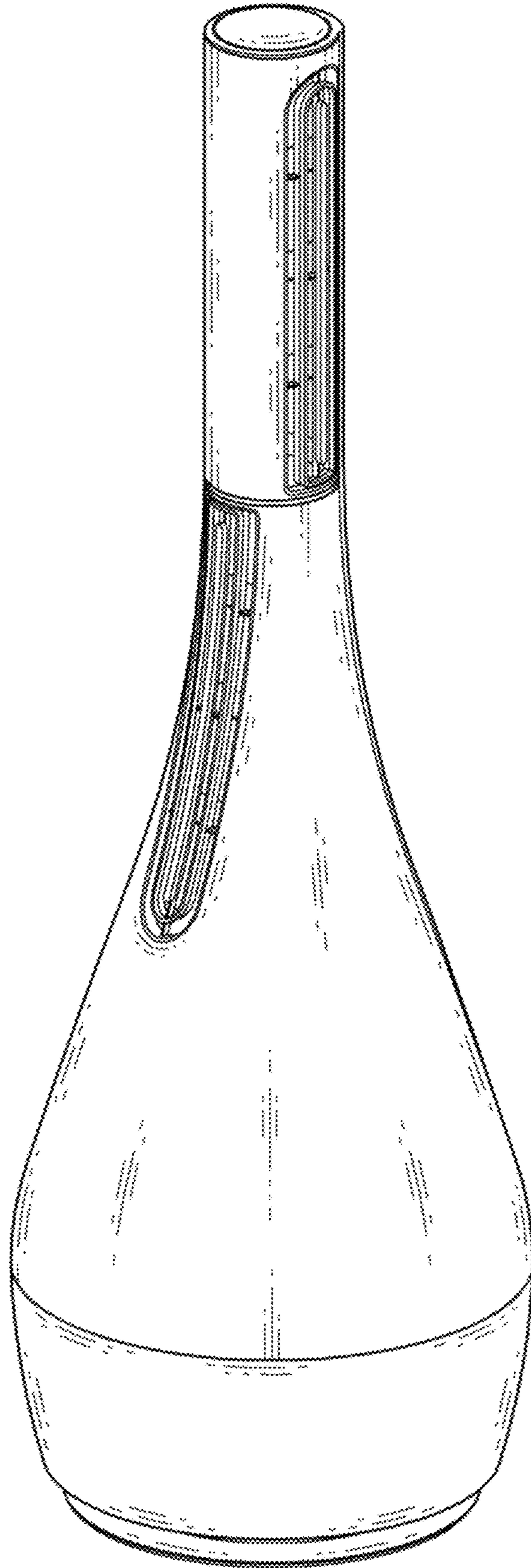

1.9

