



US00D802617S

(12) **United States Design Patent** (10) **Patent No.:** **US D802,617 S**
Pitman et al. (45) **Date of Patent:** **** Nov. 14, 2017**

(54) **DISPLAY SCREEN OR PORTION THEREOF WITH ANIMATED COMPUTER GENERATED DIALOG GUI**

(71) Applicant: **OPEN TEXT SA ULC**, Halifax (CA)
(72) Inventors: **Jonathon Pitman**, Waterloo (CA);
Craig Reidel, Waterloo (CA); **Gregory Beckman**, Kitchener (CA)
(73) Assignee: **Open Text SA ULC**, Halifax (CA)
(**) Term: **15 Years**
(21) Appl. No.: **29/596,303**
(22) Filed: **Mar. 7, 2017**

Related U.S. Application Data

(63) Continuation of application No. 29/546,269, filed on Nov. 20, 2015, now Pat. No. Des. 783,657.
(51) **LOC (10) Cl.** **14-04**
(52) **U.S. Cl.**
USPC **D14/486**
(58) **Field of Classification Search**
USPC D14/485-495

(Continued)

(56) **References Cited**

U.S. PATENT DOCUMENTS

D578,135 S 10/2008 Nathan et al.
D599,363 S * 9/2009 Mays D14/485
(Continued)

OTHER PUBLICATIONS

Notice of Allowance issued for Design U.S. Appl. No. 29/546,269, mailed Nov. 28, 2016, 9 pages.

Primary Examiner — Philip S Hyder
Assistant Examiner — Cary M Robinson

(74) *Attorney, Agent, or Firm* — Sprinkle IP Law Group

(57) **CLAIM**

The ornamental design for a display screen or portion thereof with an animated computer generated dialog GUI, as shown and described.

DESCRIPTION

FIG. 1 is the first image in a sequence for a display screen or portion thereof with an animated computer generated dialog GUI showing an embodiment of our new design; FIG. 2 is the second image thereof; FIG. 3 is the third image thereof; FIG. 4 is the fourth image thereof; FIG. 5 is the fifth image thereof; FIG. 6 is the sixth image thereof; FIG. 7 is the seventh image thereof; FIG. 8 is the eighth image thereof; FIG. 9 is the ninth image thereof; FIG. 10 is the tenth image thereof; FIG. 11 is the eleventh image thereof; FIG. 12 is the twelfth image thereof; FIG. 13 is the thirteenth image thereof; FIG. 14 is the fourteenth image thereof; FIG. 15 is the fifteenth image thereof; FIG. 16 is the sixteenth image thereof; FIG. 17 is the seventeenth image thereof; FIG. 18 is the first image in a sequence for a display screen with an animated computer generated dialog GUI showing the sequence of FIGS. 1-17 in the context of a different environment; FIG. 19 is the second image thereof; FIG. 20 is the third image thereof; FIG. 21 is the fourth image thereof; FIG. 22 is the fifth image thereof; FIG. 23 is the sixth image thereof; FIG. 24 is the seventh image thereof; FIG. 25 is the eighth image thereof; FIG. 26 is the ninth image thereof; FIG. 27 is the tenth image thereof; FIG. 28 is the eleventh image thereof; FIG. 29 is the twelfth image thereof;

(Continued)

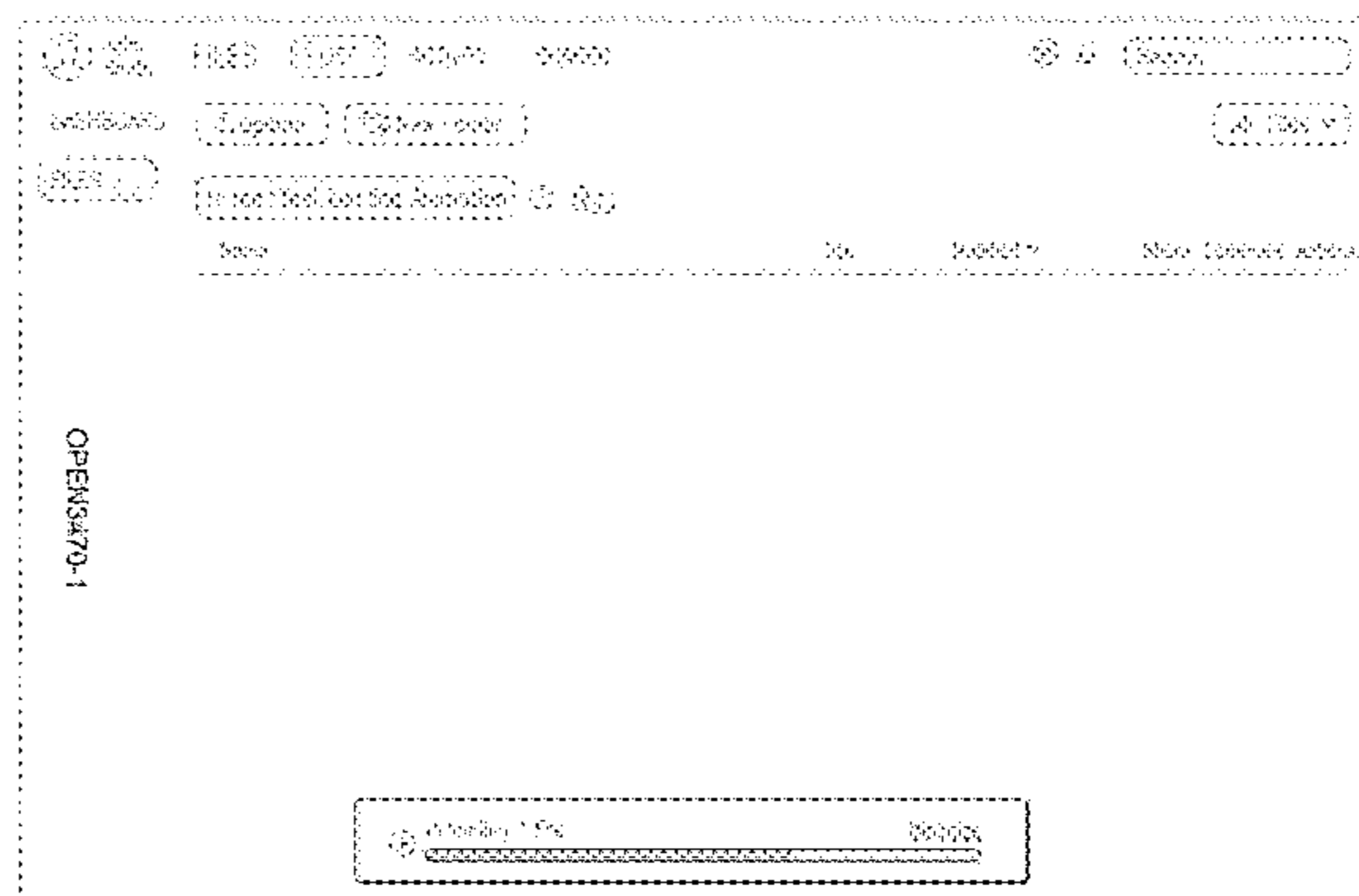
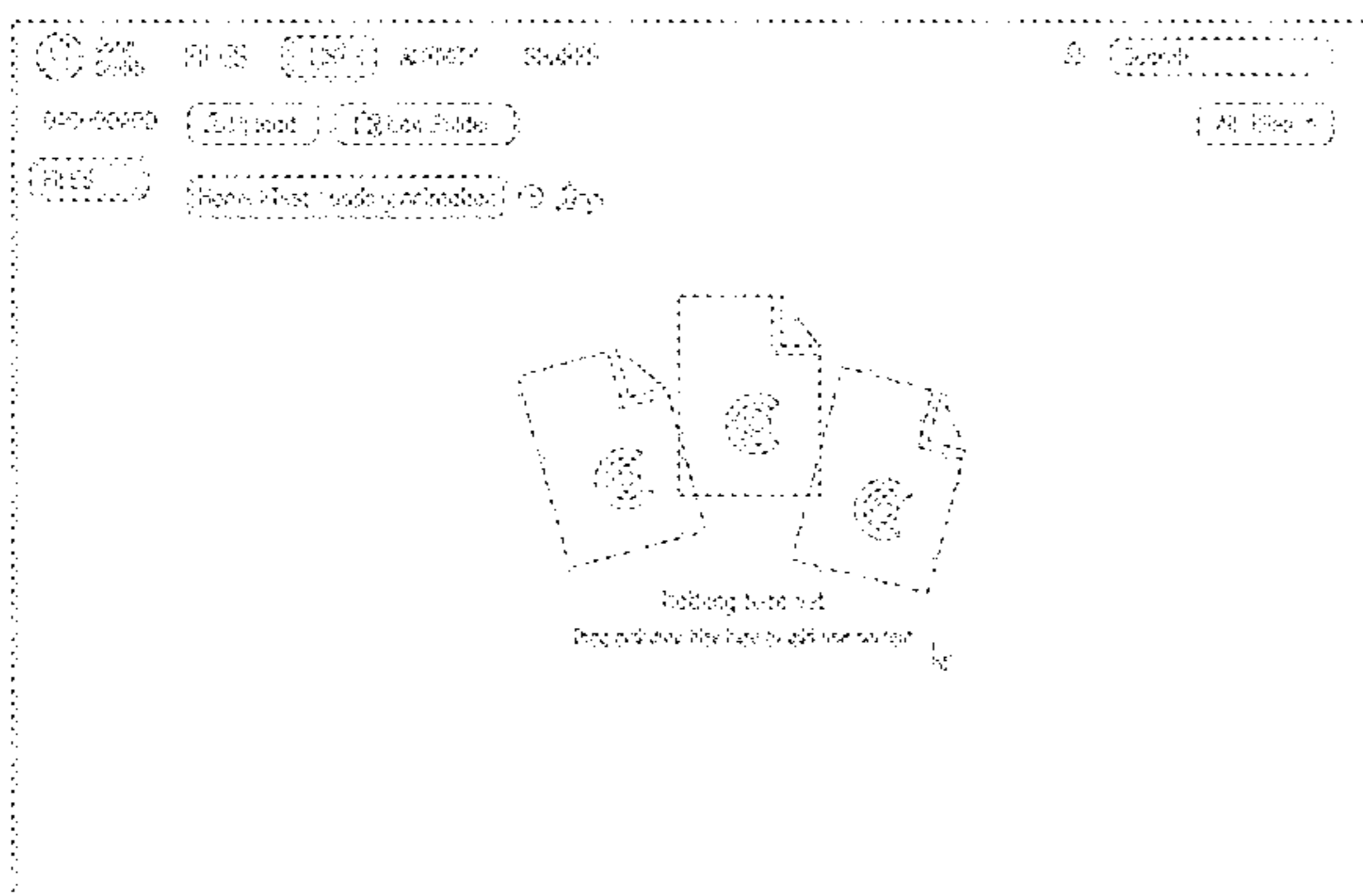


FIG. 30 is the thirteenth image thereof;
 FIG. 31 is the fourteenth image thereof;
 FIG. 32 is the fifteenth image thereof;
 FIG. 33 is the sixteenth image thereof;
 FIG. 34 is the seventeenth image thereof;
 FIG. 35 is the first image in a sequence for a display screen or portion thereof with an animated computer generated dialog GUI showing another embodiment of our new design;
 FIG. 36 is the second image thereof;
 FIG. 37 is the third image thereof;
 FIG. 38 is the fourth image thereof;
 FIG. 39 is the fifth image thereof;
 FIG. 40 is the sixth image thereof;
 FIG. 41 is the seventh image thereof;
 FIG. 42 is the eighth image thereof;
 FIG. 43 is the ninth image thereof;
 FIG. 44 is the tenth image thereof;
 FIG. 45 is the eleventh image thereof;
 FIG. 46 is the twelfth image thereof;
 FIG. 47 is the thirteenth image thereof;
 FIG. 48 is the fourteenth image thereof;
 FIG. 49 is the fifteenth image thereof;
 FIG. 50 is the sixteenth image thereof; and,
 FIG. 51 is the seventeenth image thereof.

The appearance of the animated computer generated dialog sequentially transitions between the images shown in FIGS. 1-17, 18-34, and 35-51. The process or period in which one image transitions to another forms no part of the claimed design.

The outermost broken line illustrates a display screen or portion thereof. The broken line showing of text and other elements illustrates portions of the animated computer generated GUI. None of the broken lines form part of the claimed design.

1 Claim, 51 Drawing Sheets

(58) **Field of Classification Search**

CPC G06F 3/0481; G06F 3/04845; G06F 3/04817; G06F 17/212; G06T 13/80; G06T 15/02; H04N 1/00424

See application file for complete search history.

(56) **References Cited**

U.S. PATENT DOCUMENTS

D671,550	S	11/2012	Chen et al.	
D689,084	S *	9/2013	Pasceri	D14/486
D689,085	S *	9/2013	Pasceri	D14/486
D707,245	S	6/2014	Bruck et al.	
D749,124	S *	2/2016	Danton	D14/488
D749,625	S	2/2016	Yang et al.	
D753,709	S	4/2016	Kawanabe	
D754,169	S *	4/2016	Kaplan	D14/486
D754,688	S	4/2016	Chaudhri et al.	
D757,070	S	5/2016	Dziuba	
D764,506	S *	8/2016	Rathke	D14/486
D765,121	S	8/2016	Butcher et al.	
D768,708	S	10/2016	Gagnier et al.	
D769,304	S	10/2016	Williamson	
D769,305	S	10/2016	Williamson	
D782,526	S *	3/2017	Rind	D14/488
D783,657	S *	4/2017	Pitman	D14/486
2010/0125791	A1 *	5/2010	Katis	H04M 3/42221 715/716
2013/0024799	A1	1/2013	Fadell et al.	
2013/0111388	A1	5/2013	Togami	
2014/0025796	A1 *	1/2014	Vibhor	H04L 41/20 709/222
2014/0164198	A1 *	6/2014	Caldwell	G06Q 40/00 705/35
2014/0282016	A1 *	9/2014	Hosier, Jr.	H04W 4/08 715/733
2016/0162127	A1	6/2016	Sepulveda et al.	

* cited by examiner

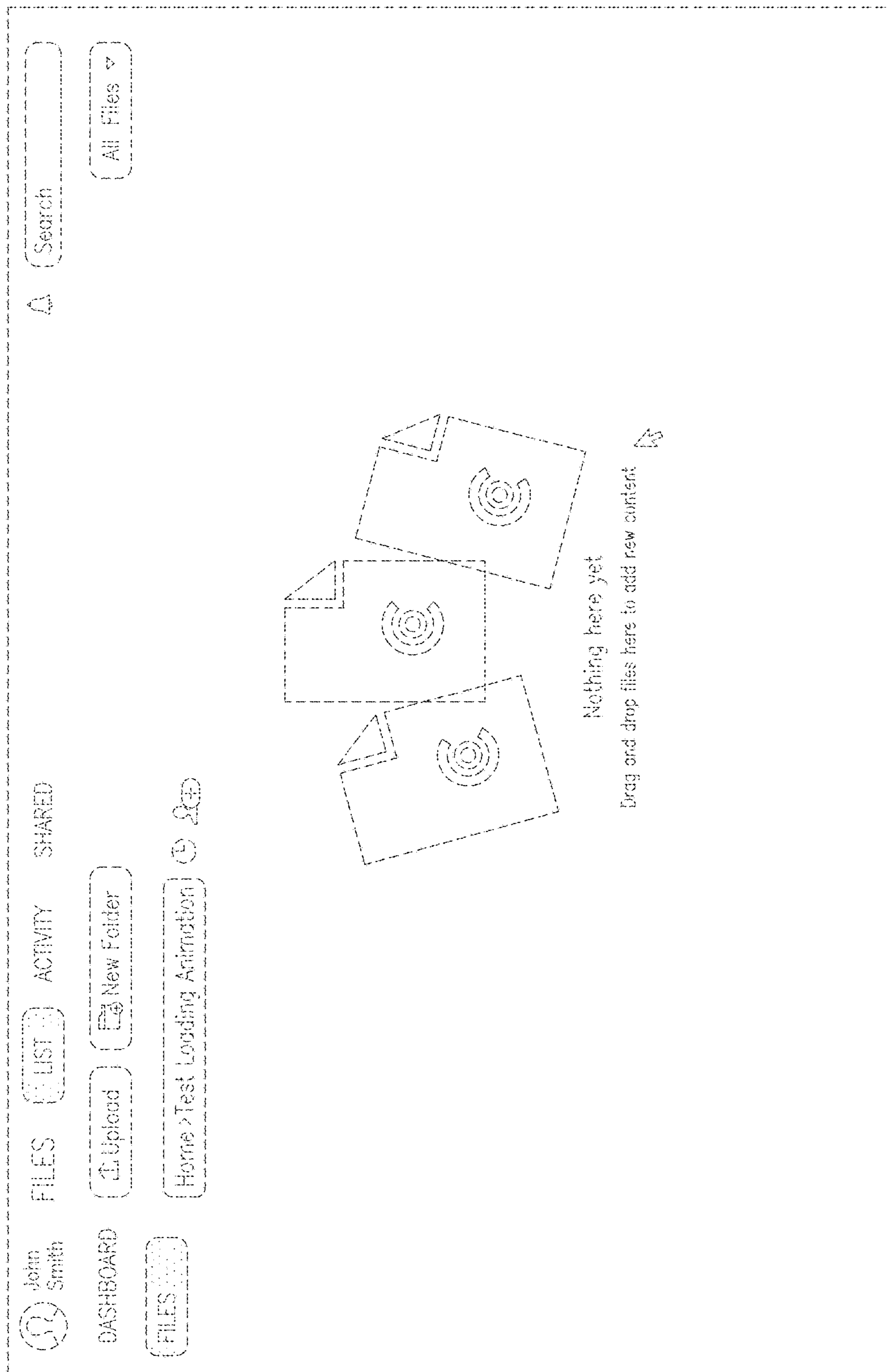


FIG. 1

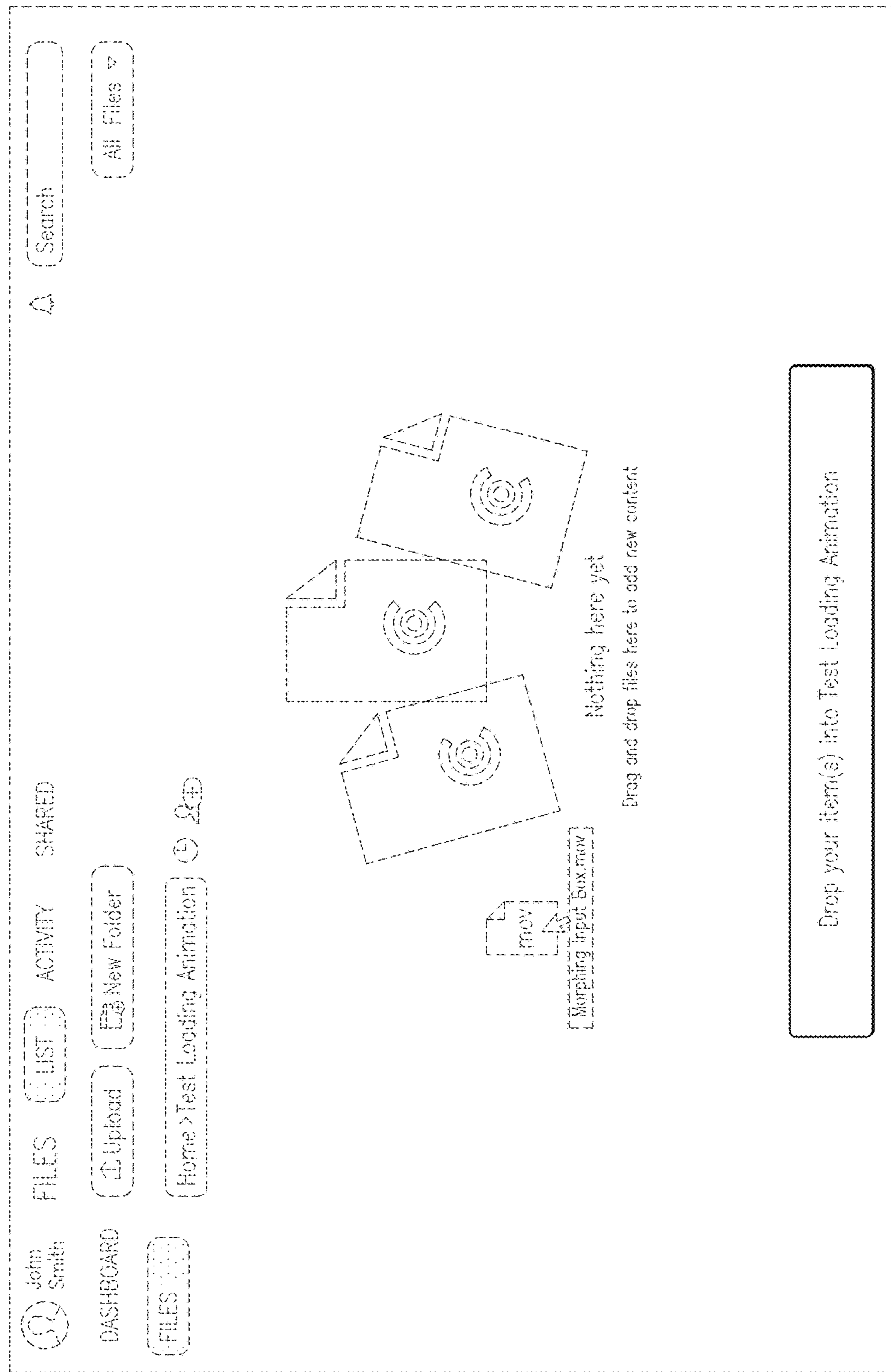


FIG. 2

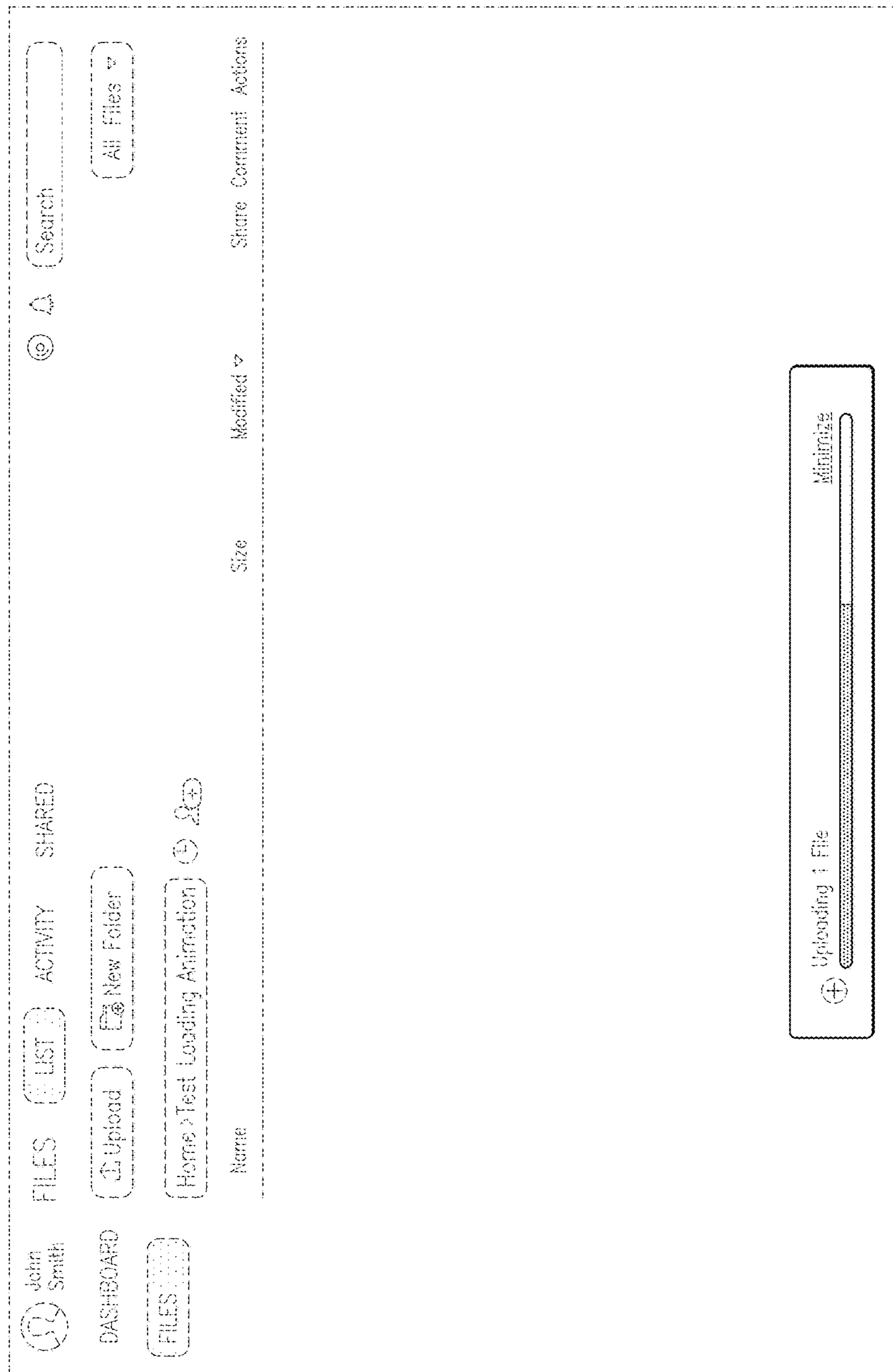


FIG. 3

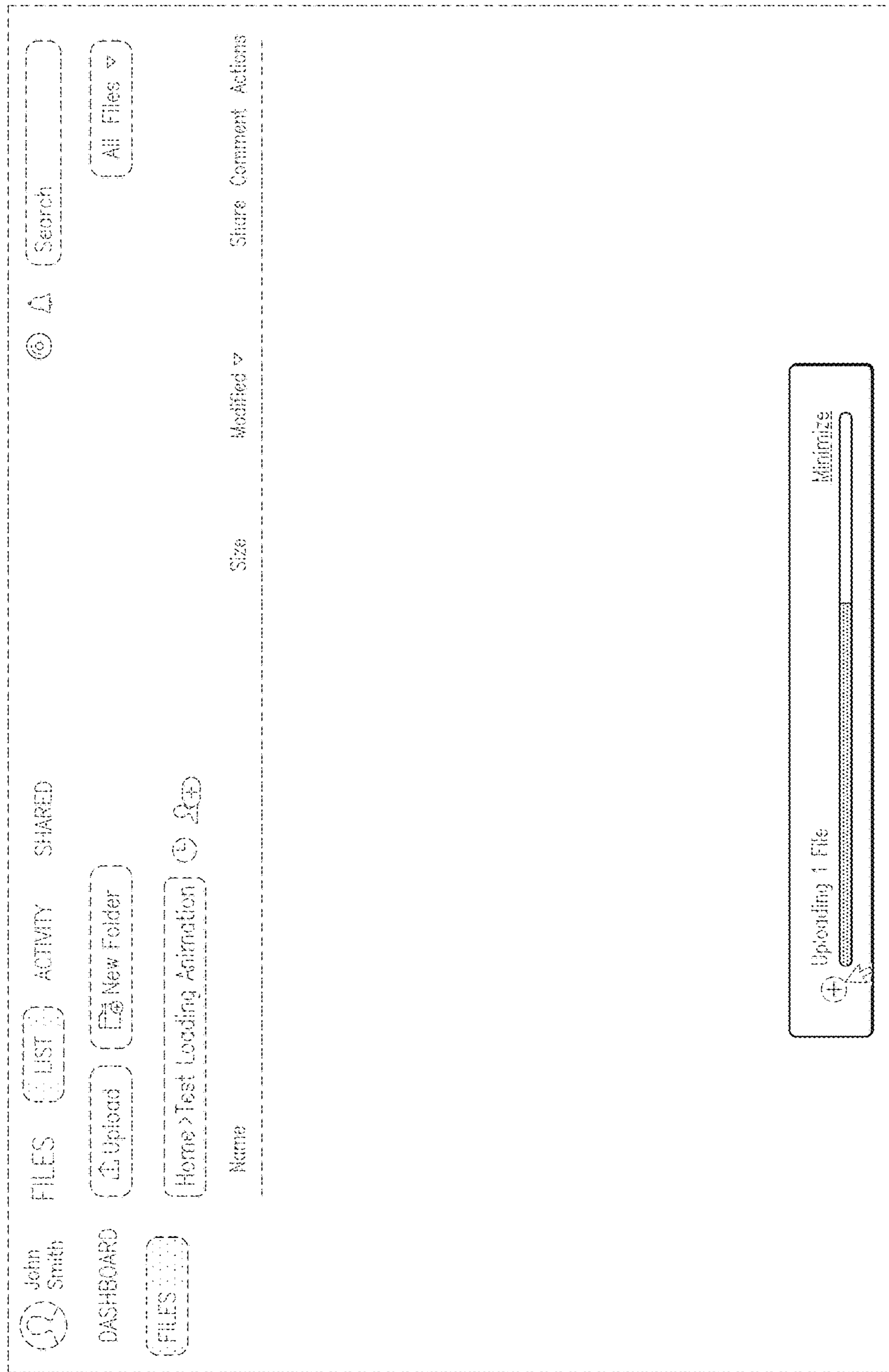


FIG. 4

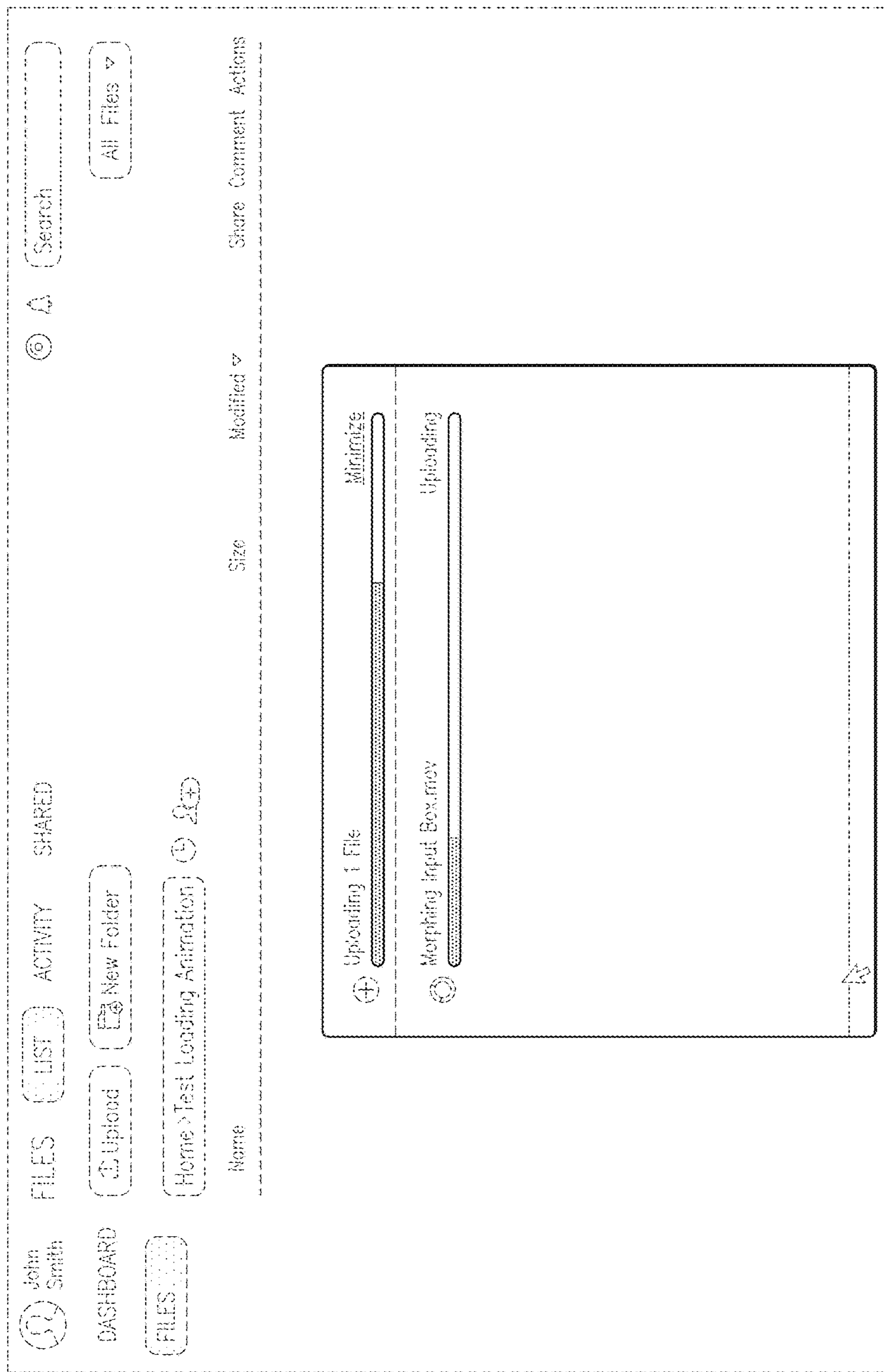


FIG. 5

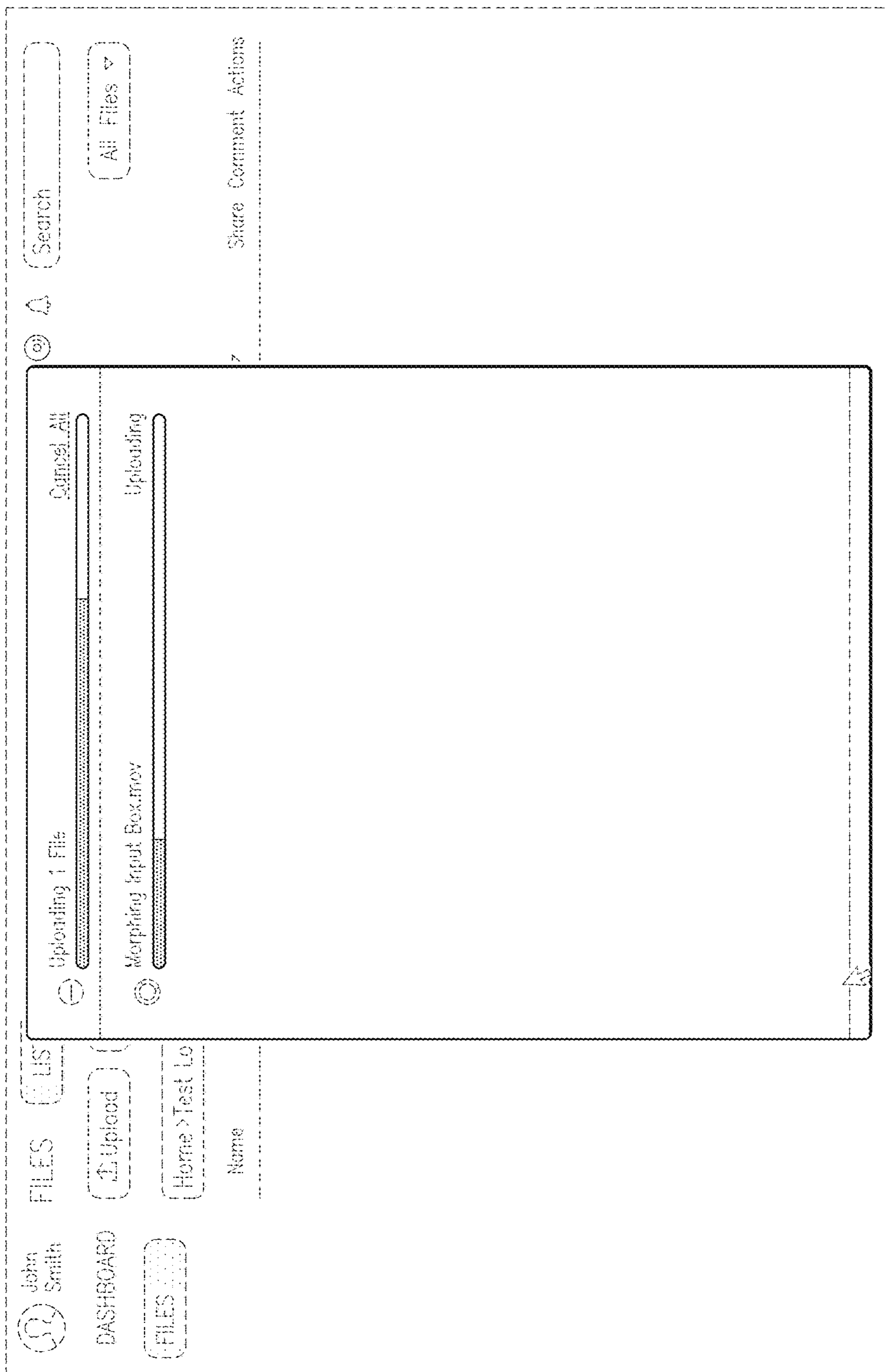


FIG. 6

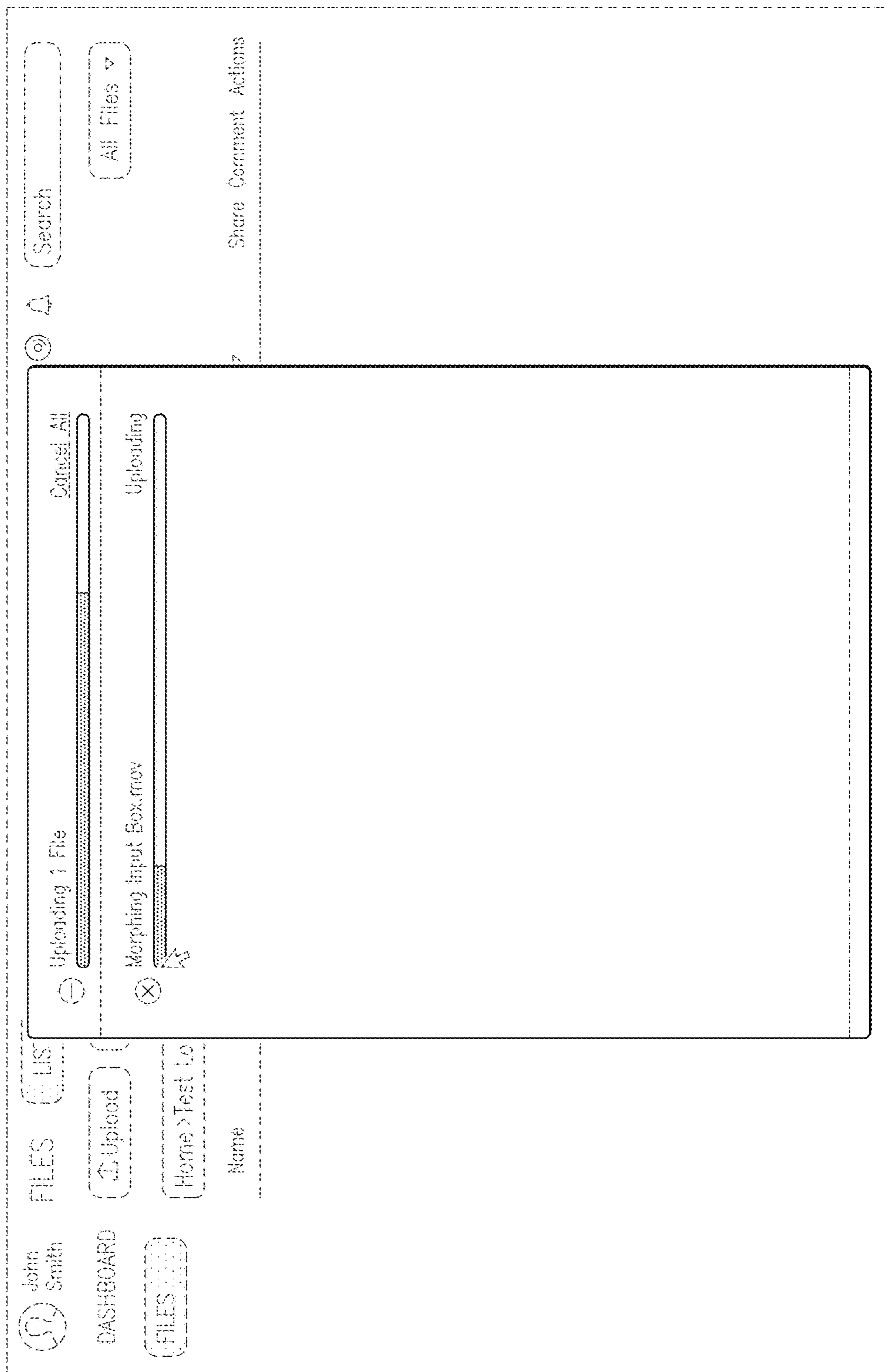


FIG. 7

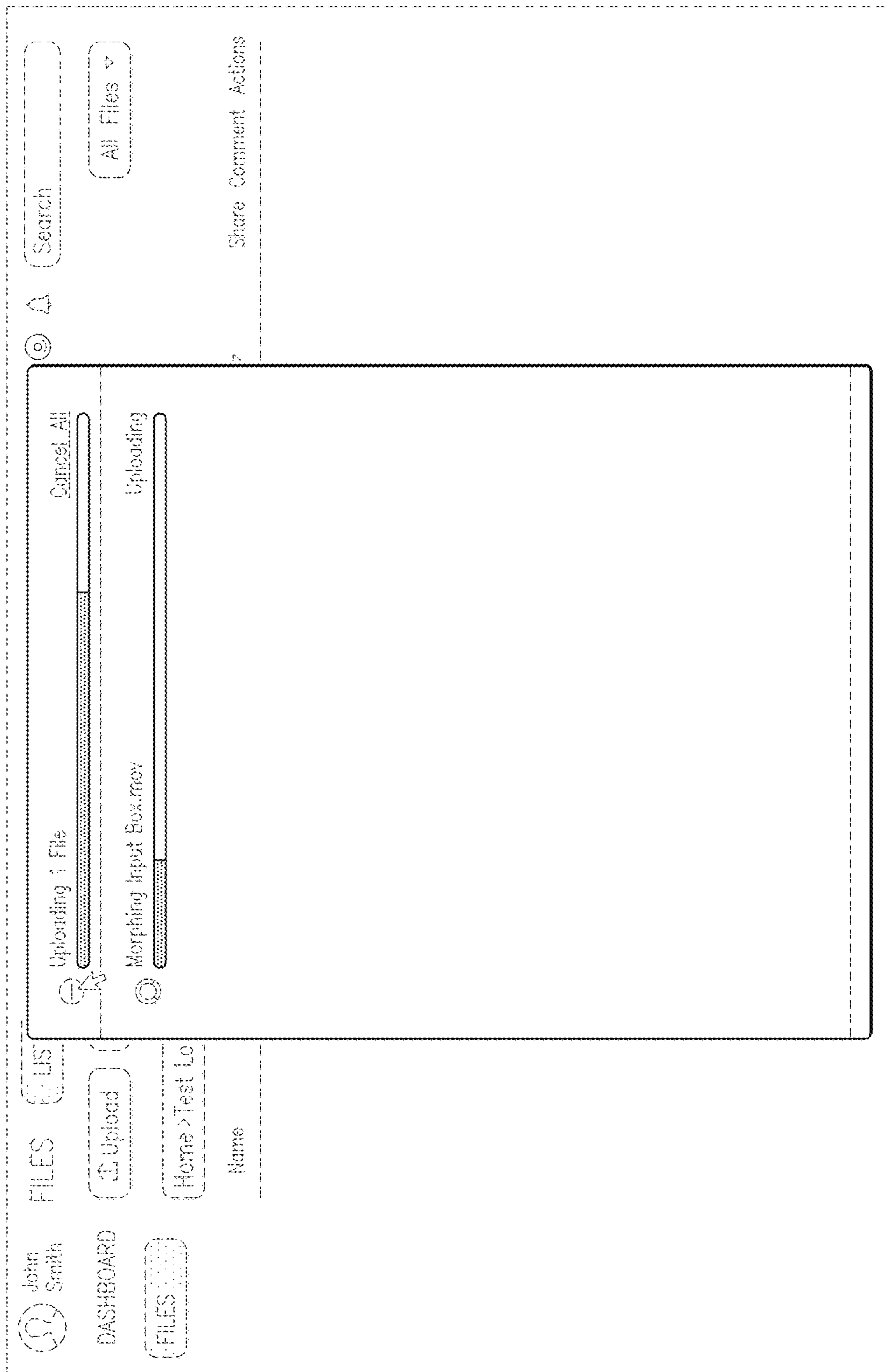


FIG. 8

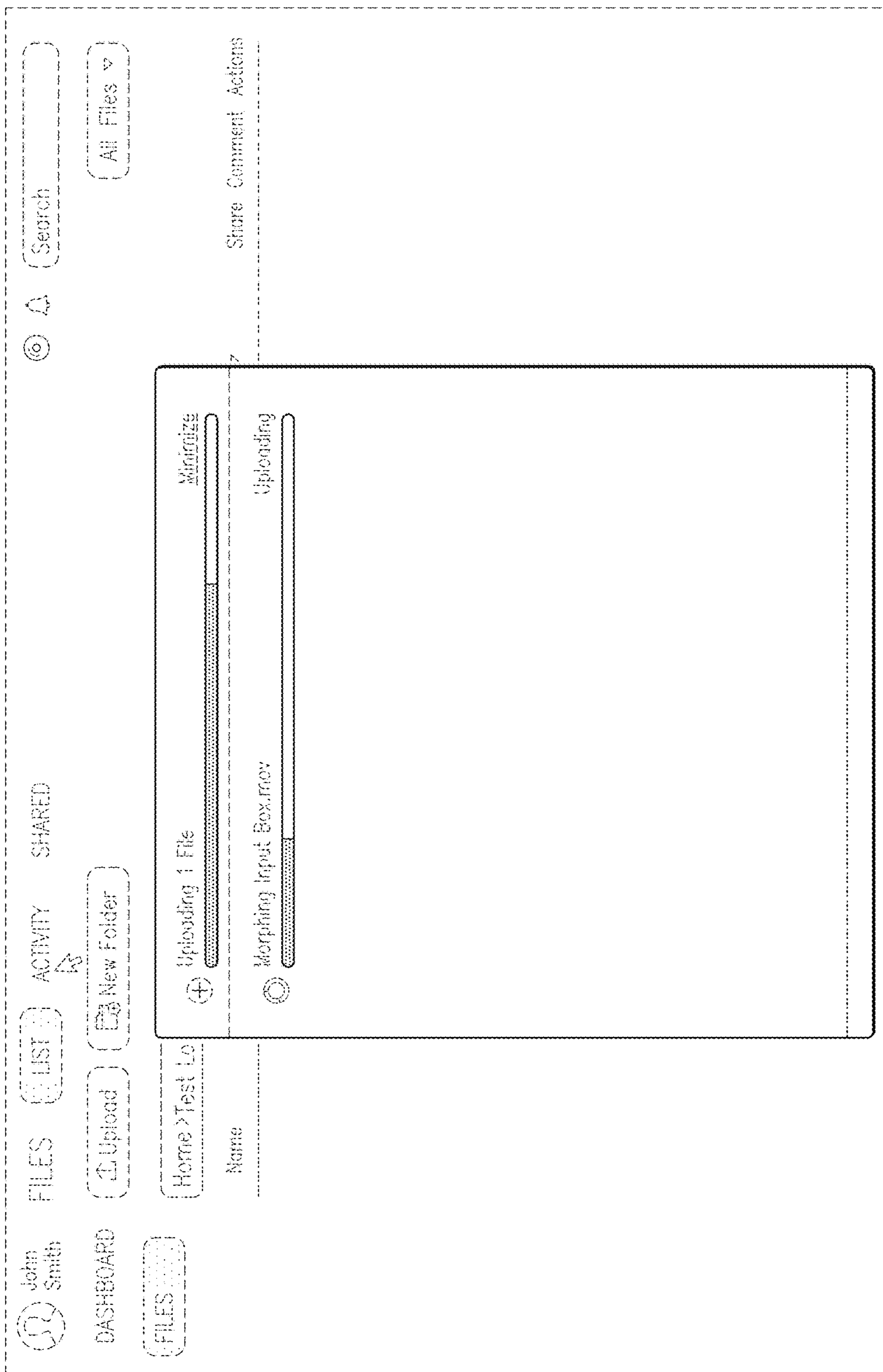


FIG. 9

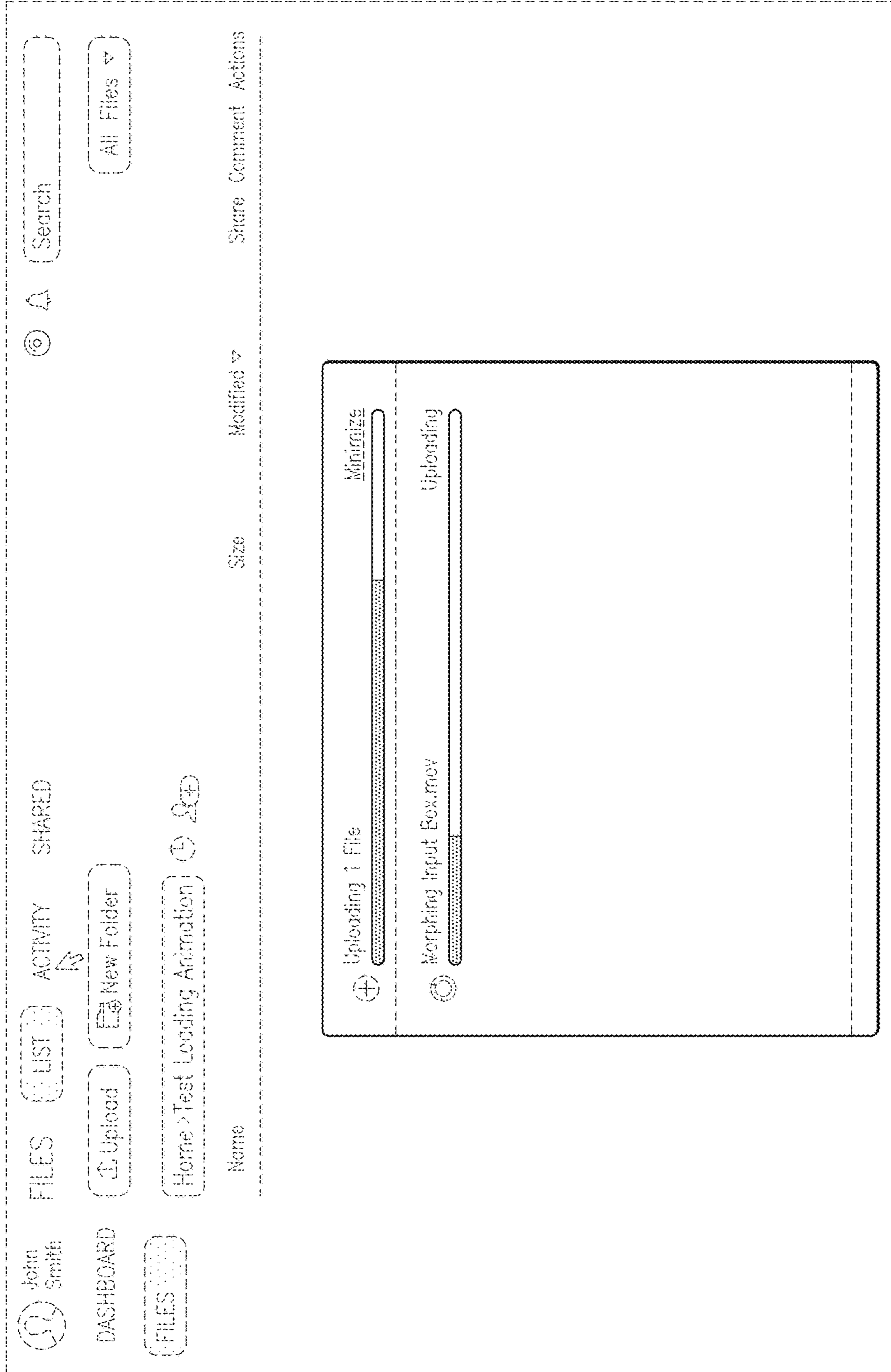


FIG. 10

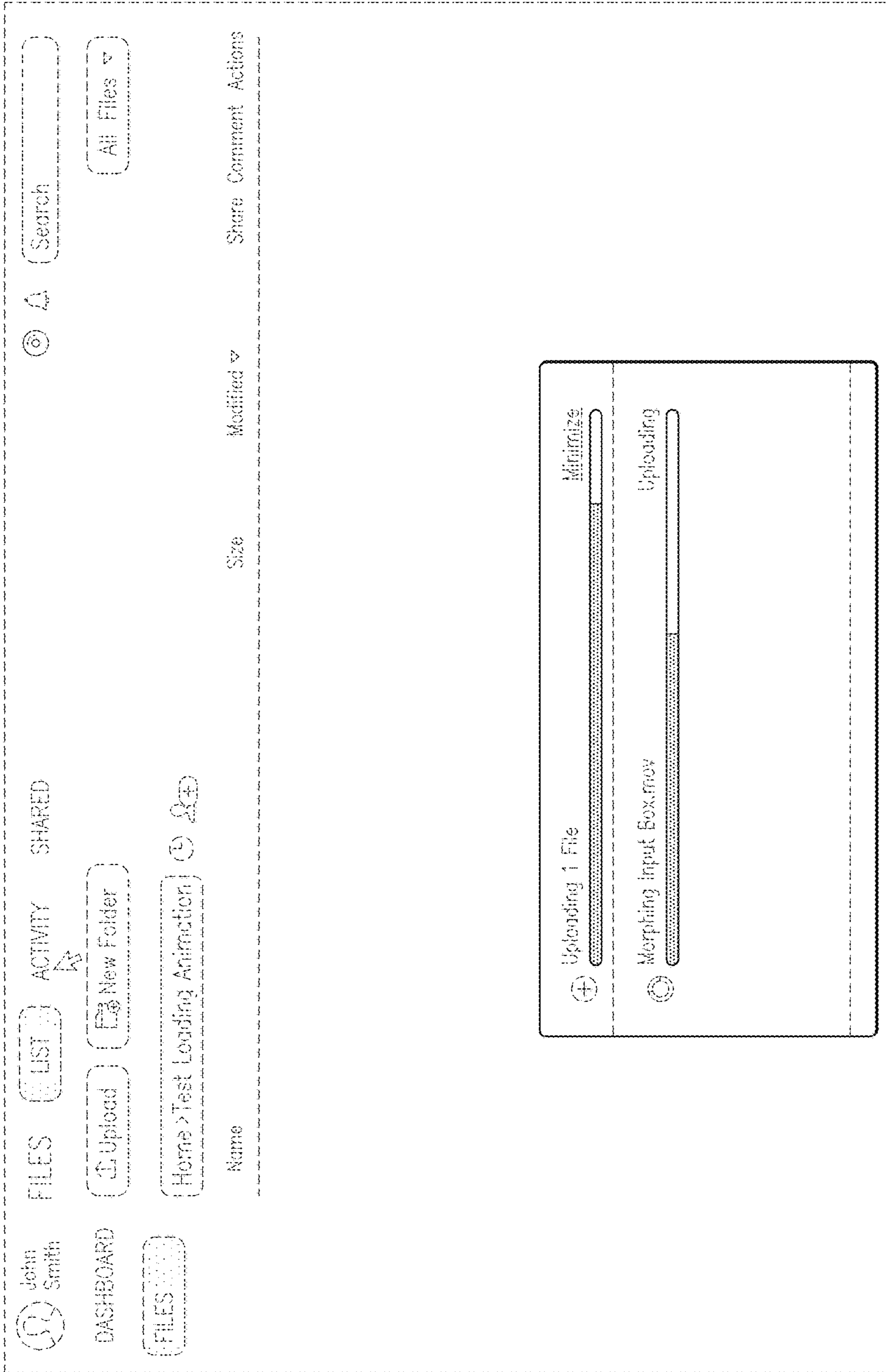


FIG. 11

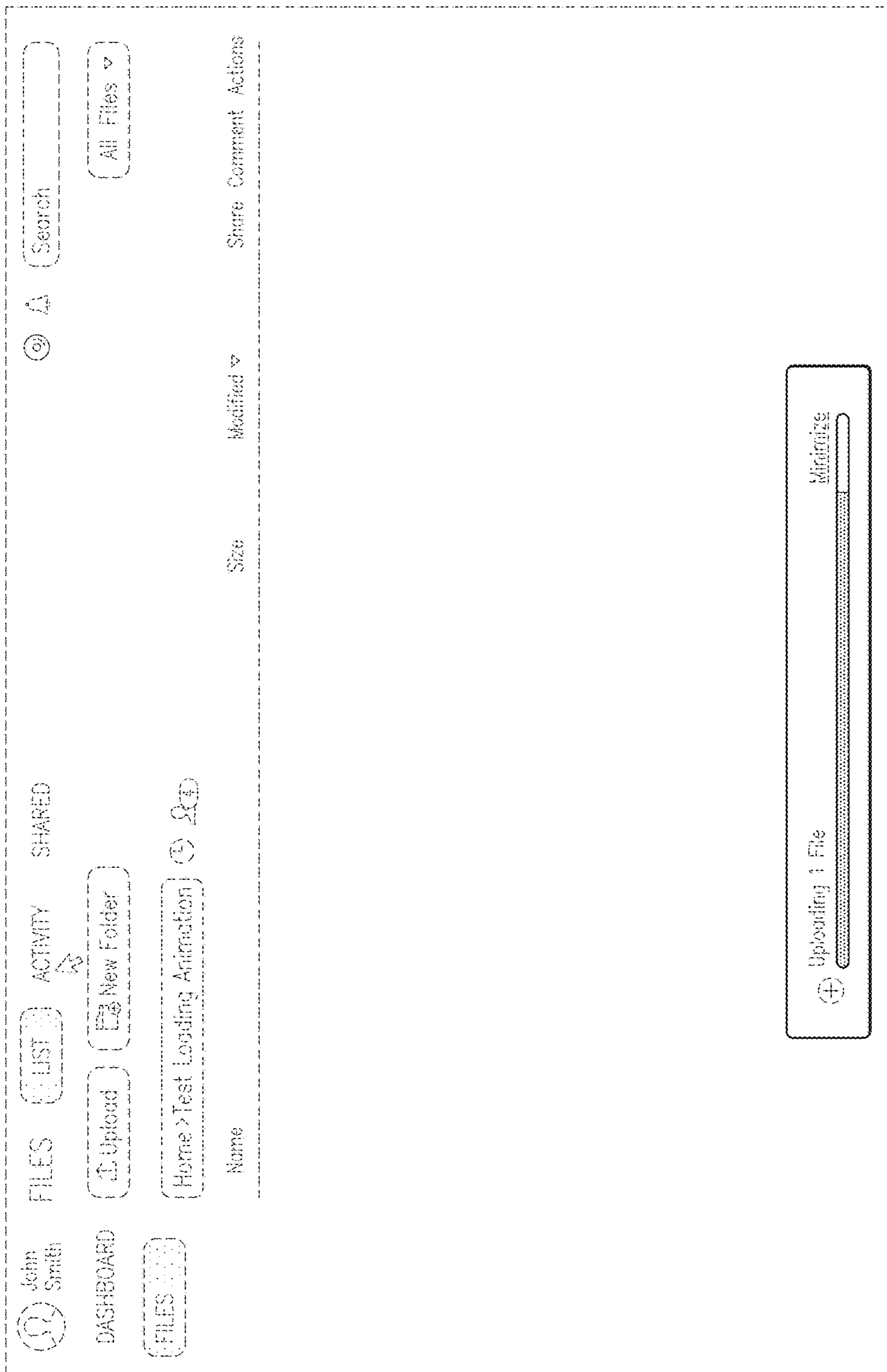


FIG. 12

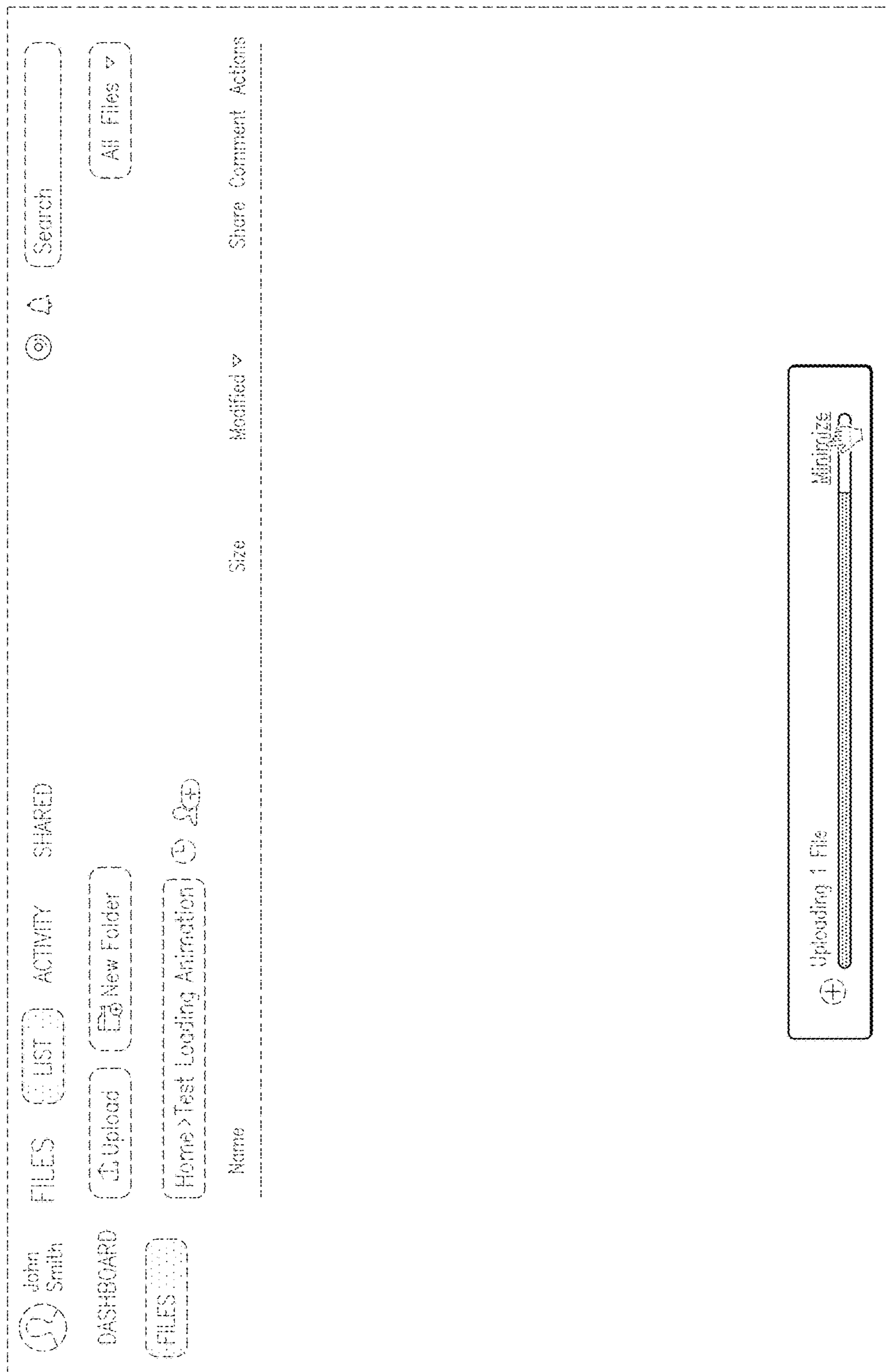


FIG. 13

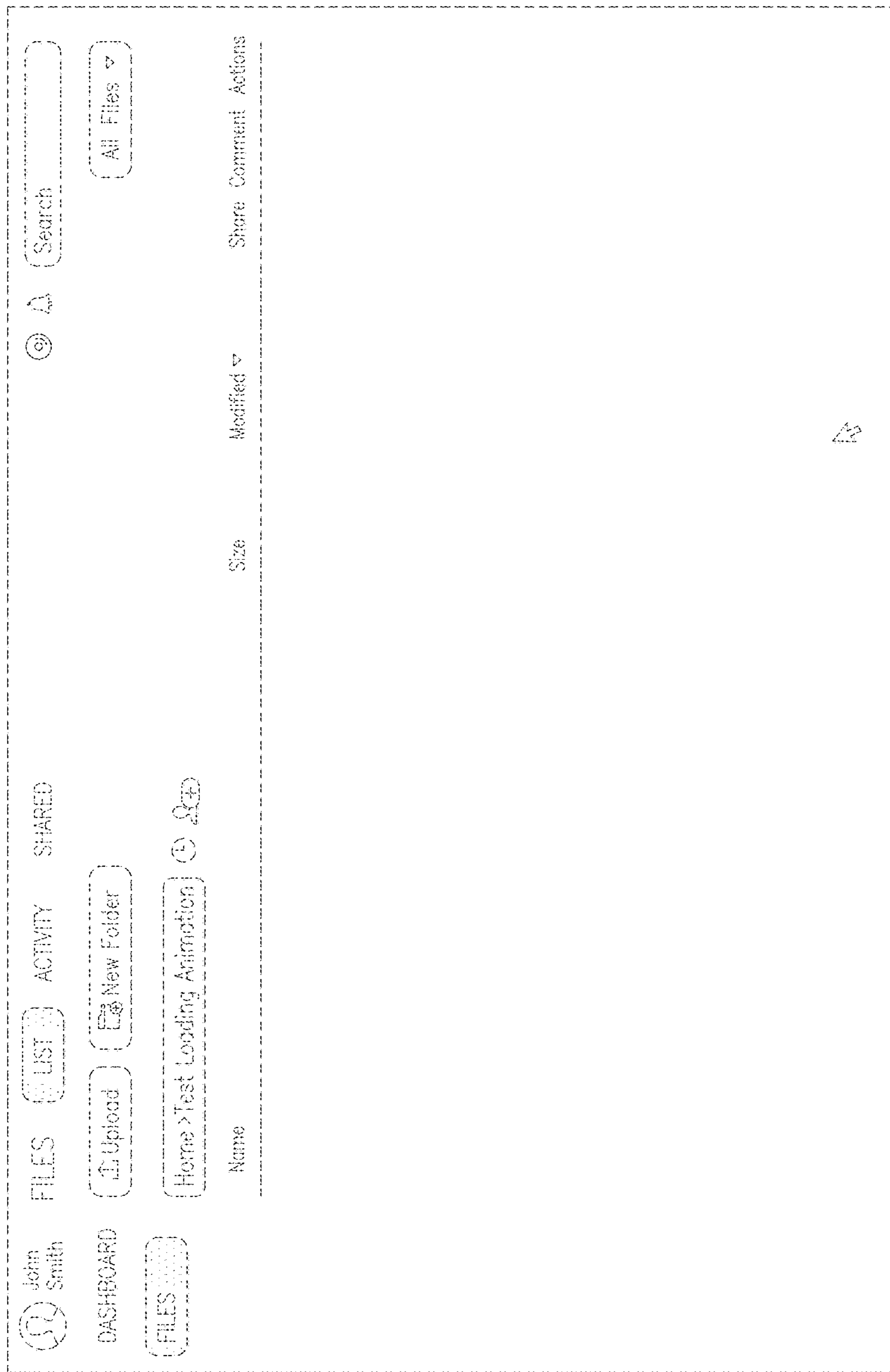


FIG. 14

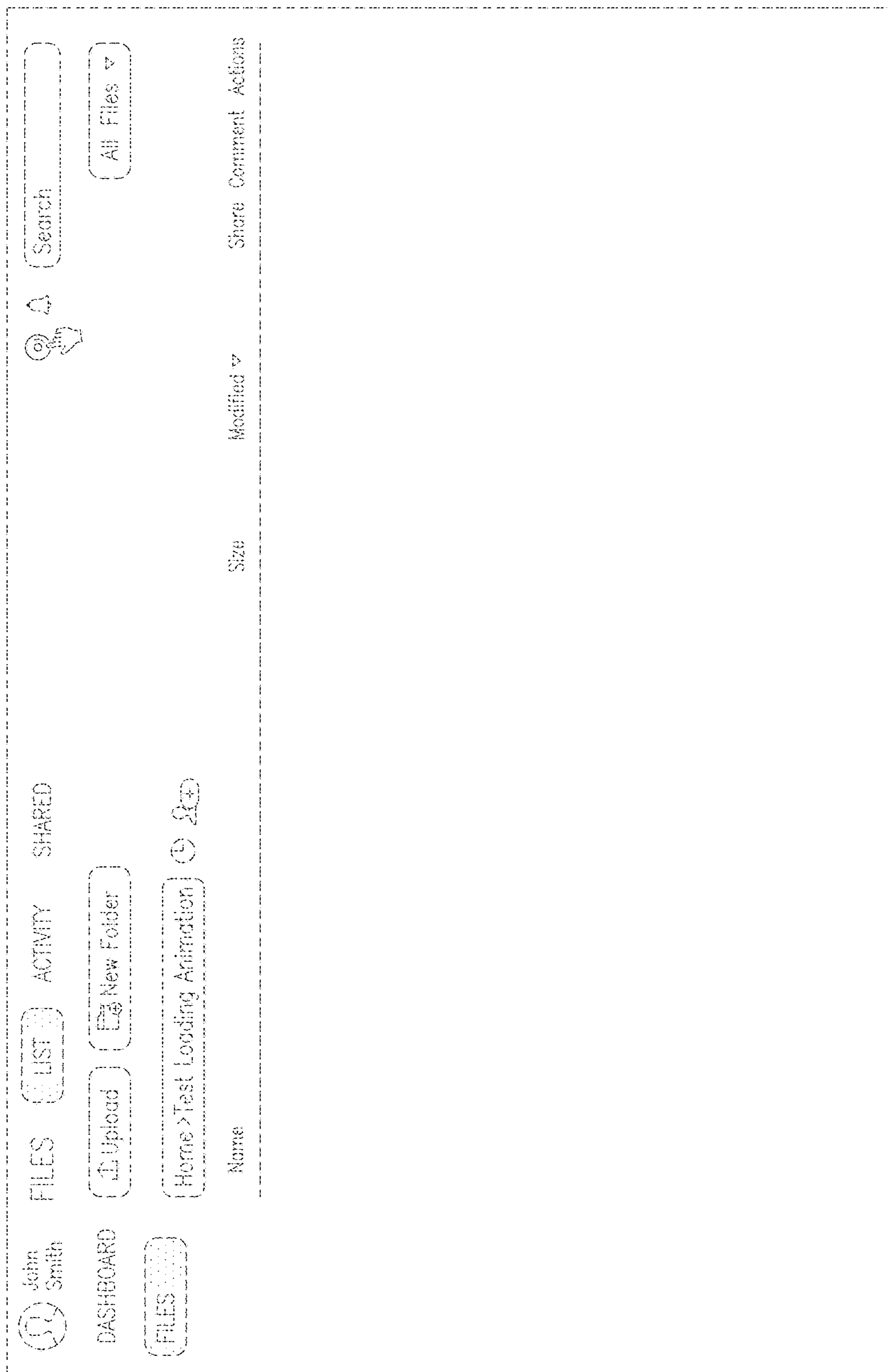


FIG. 15

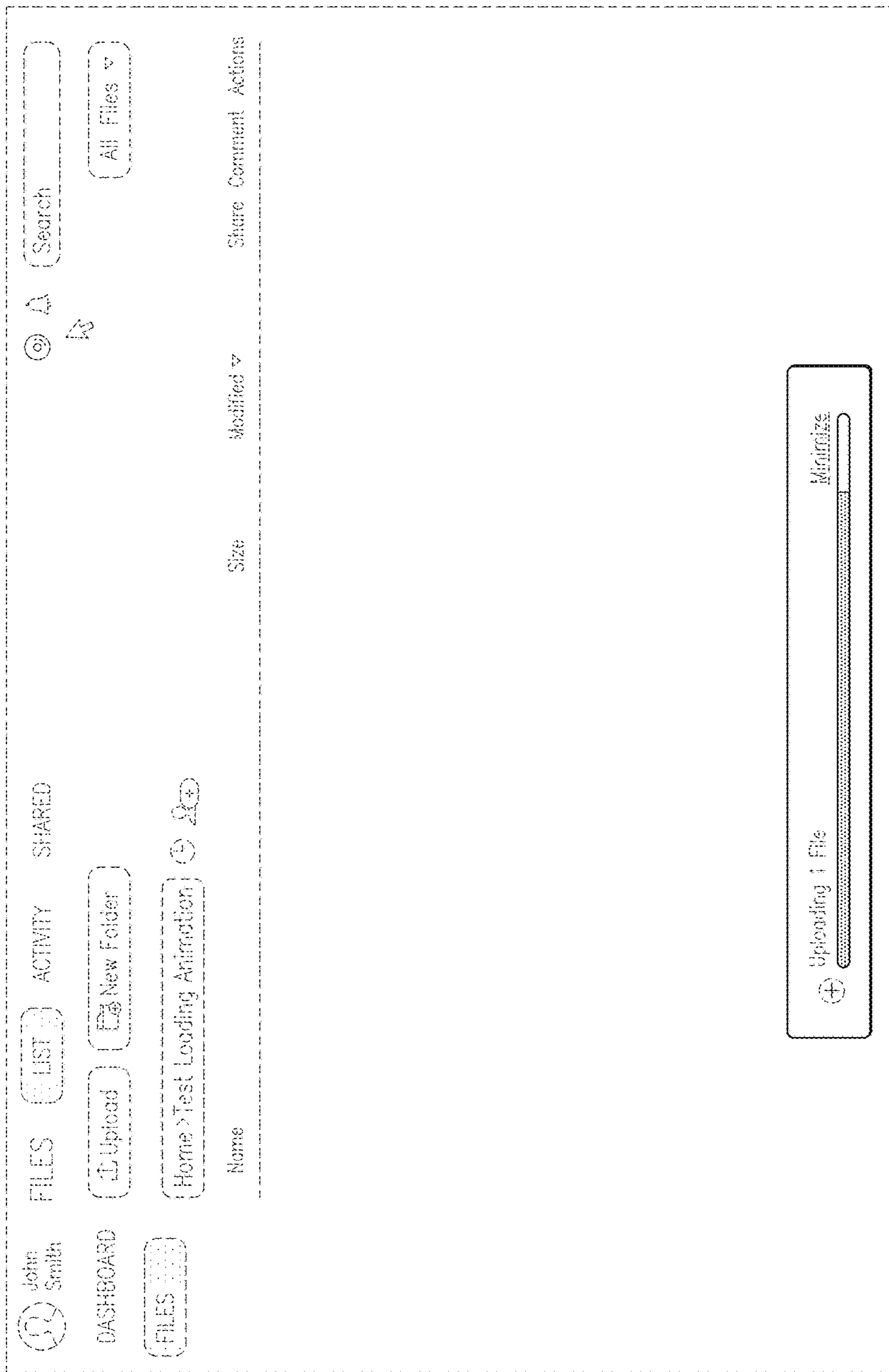


FIG. 16

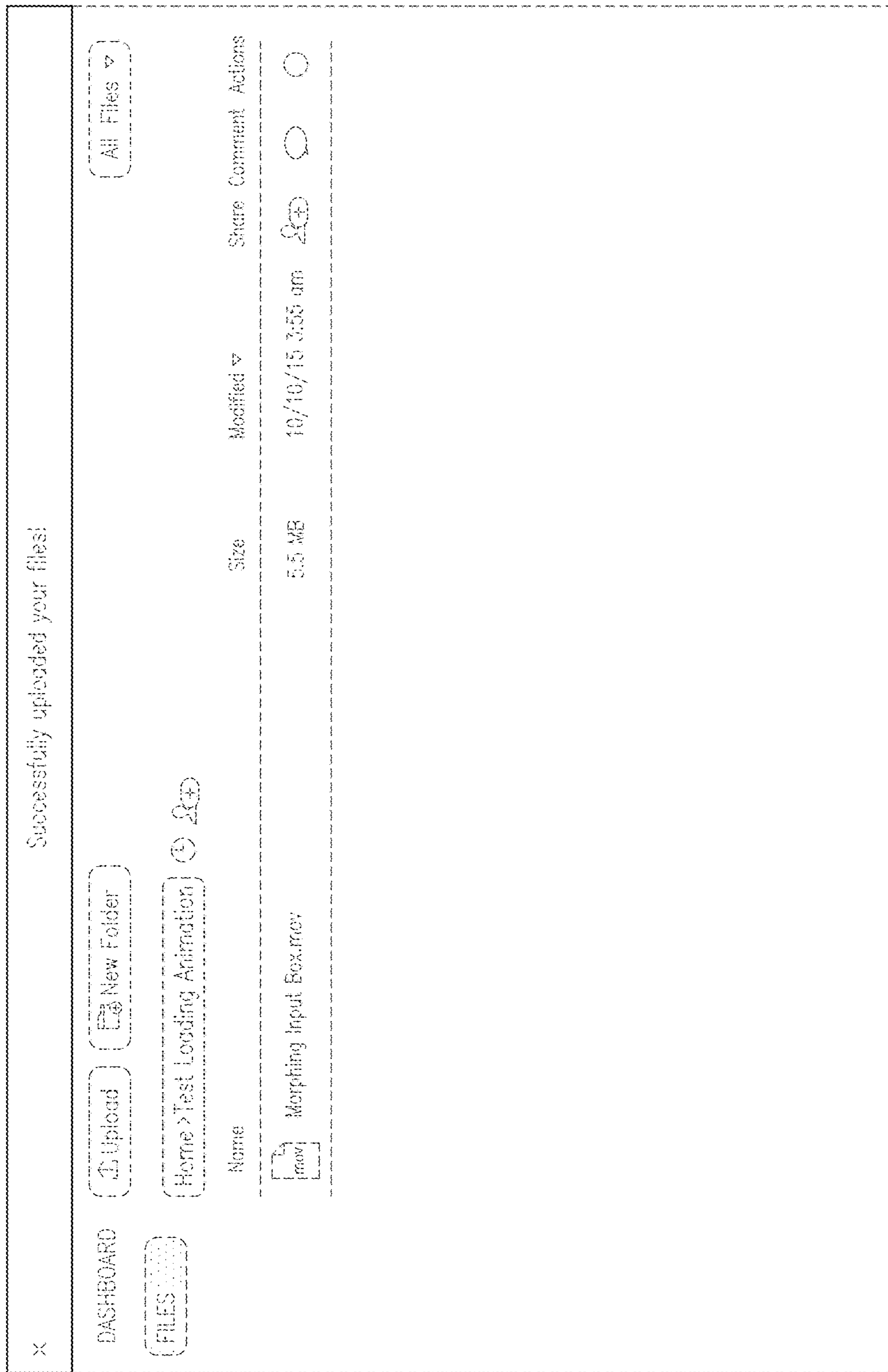


FIG. 17

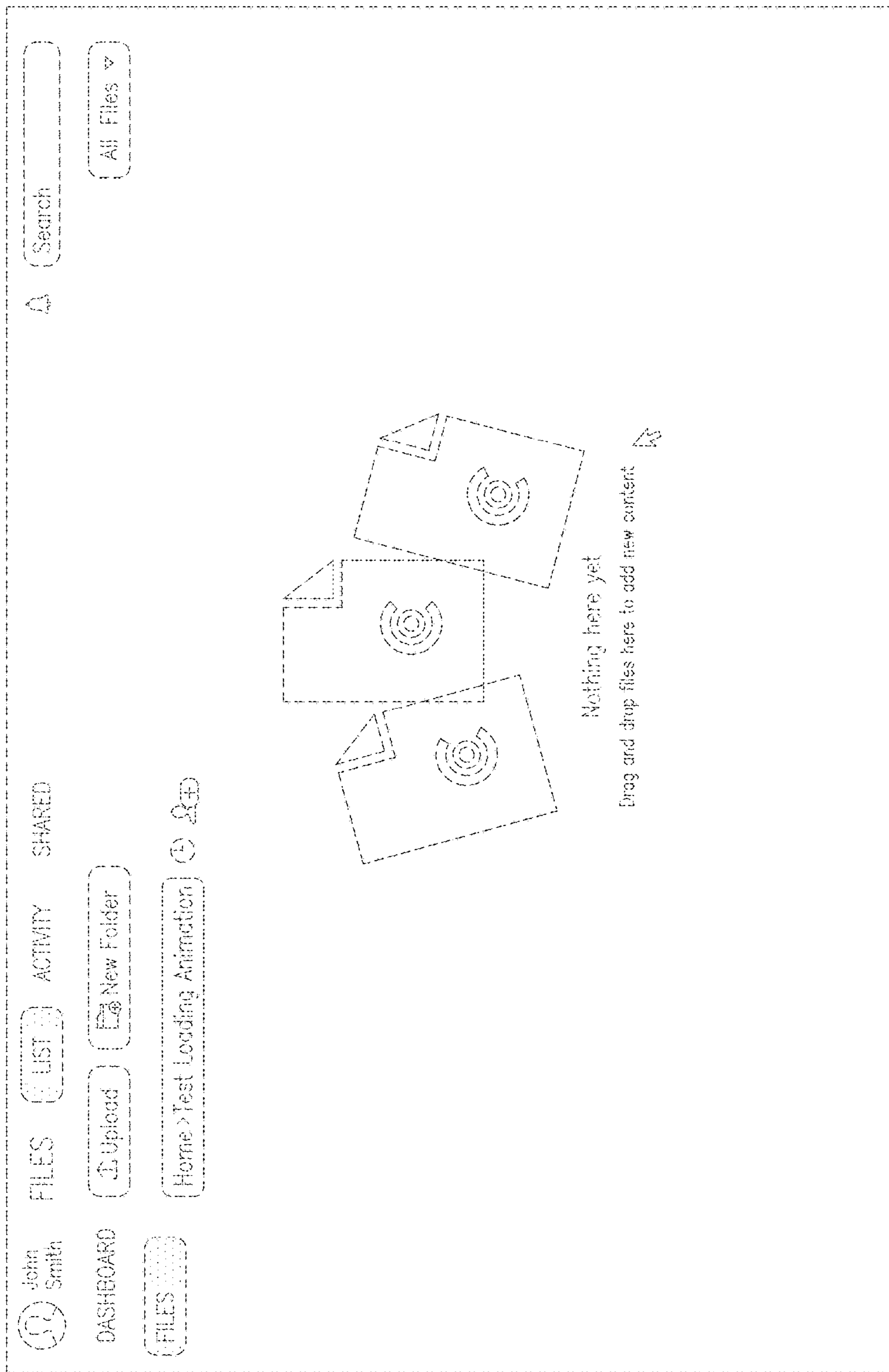


FIG. 18

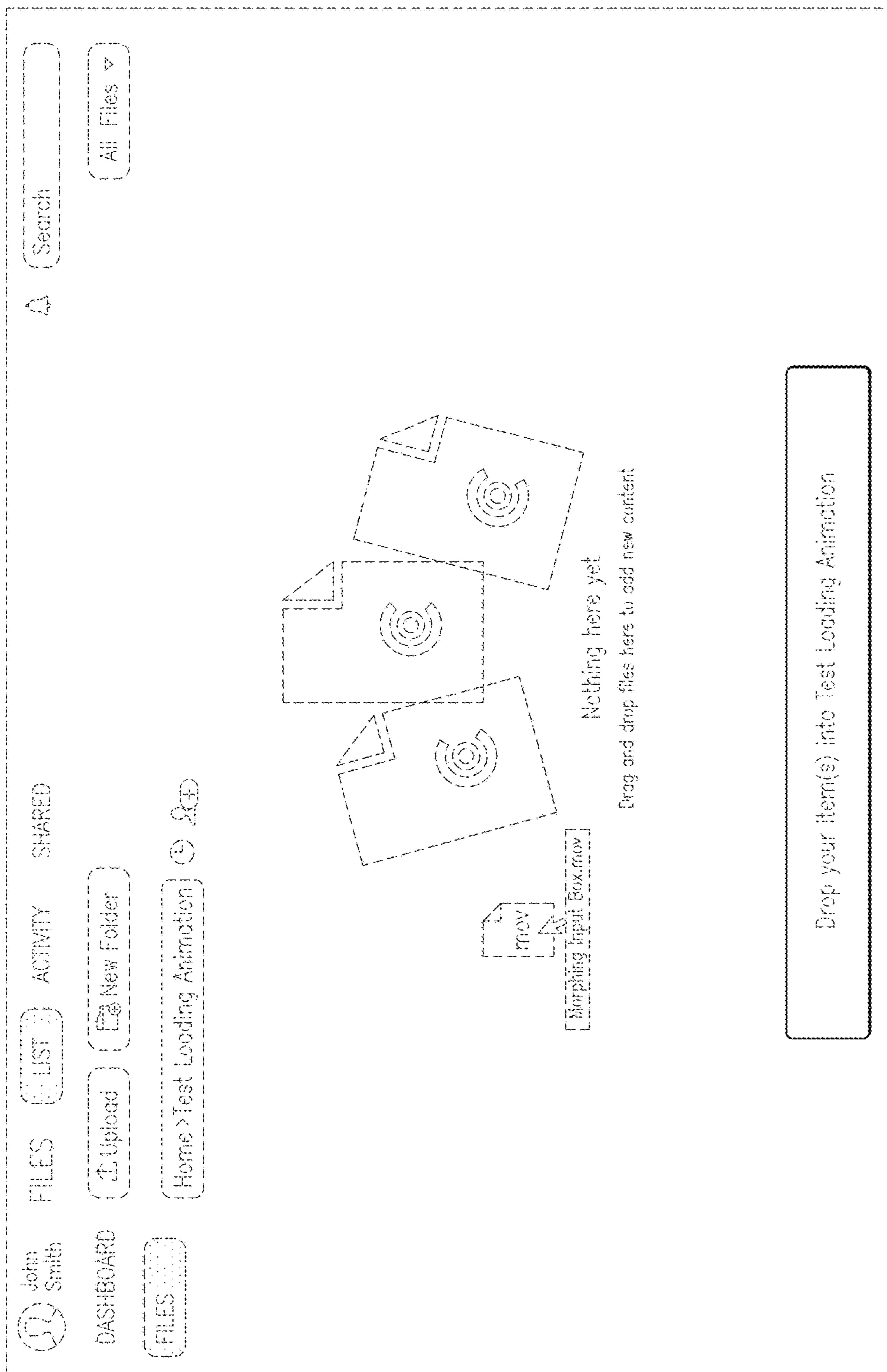


FIG. 19

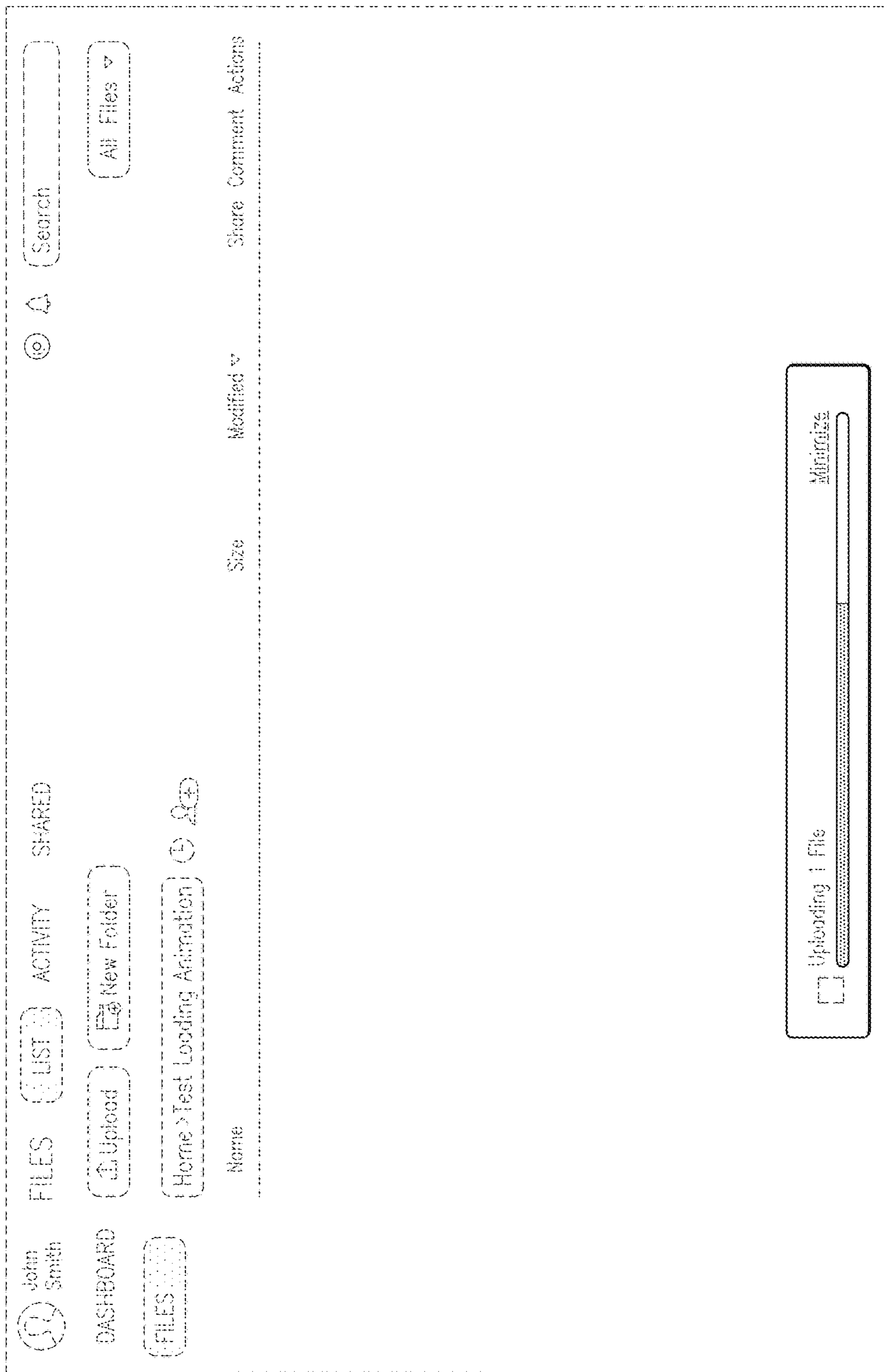


FIG. 20

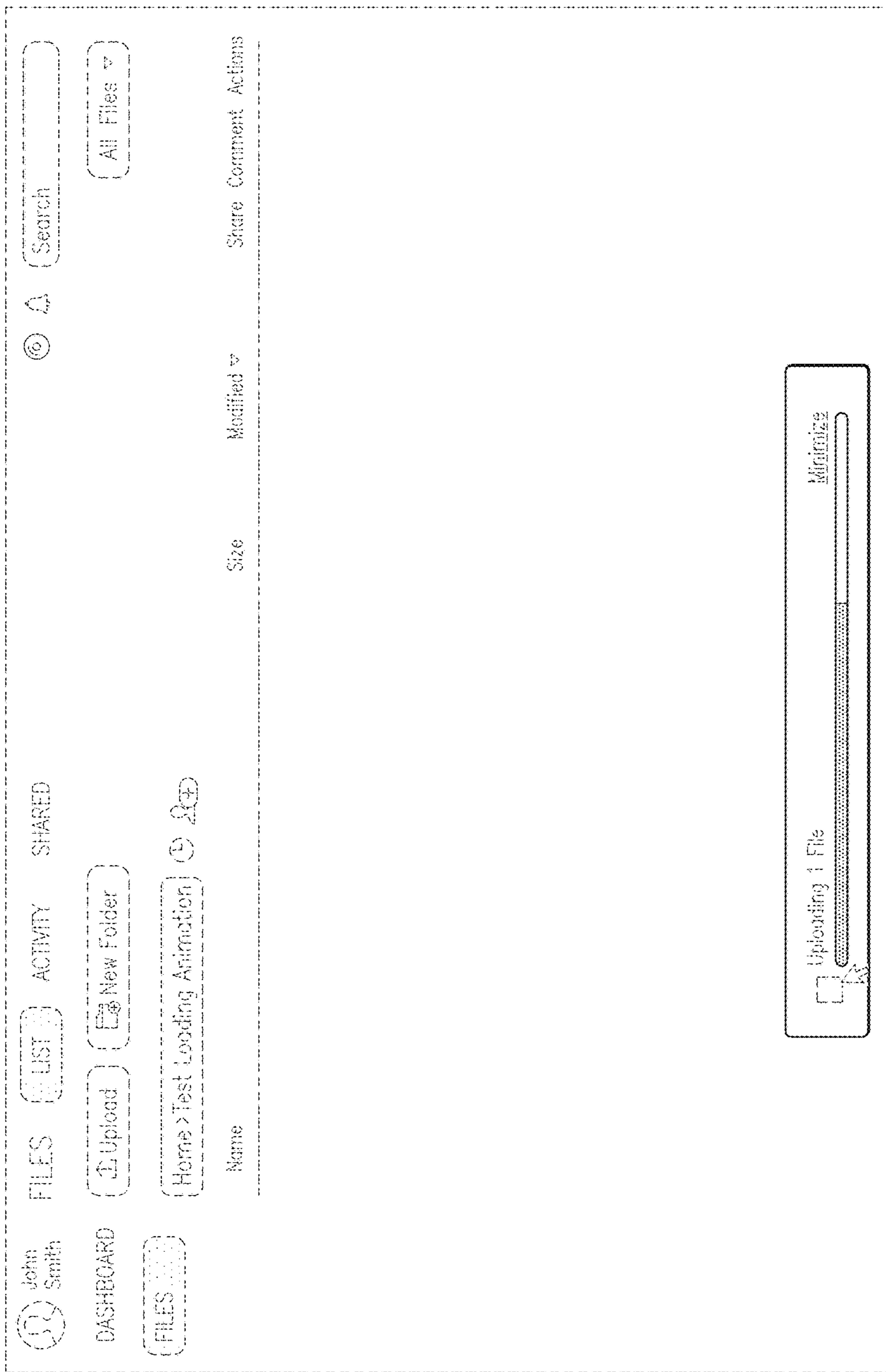


FIG. 21

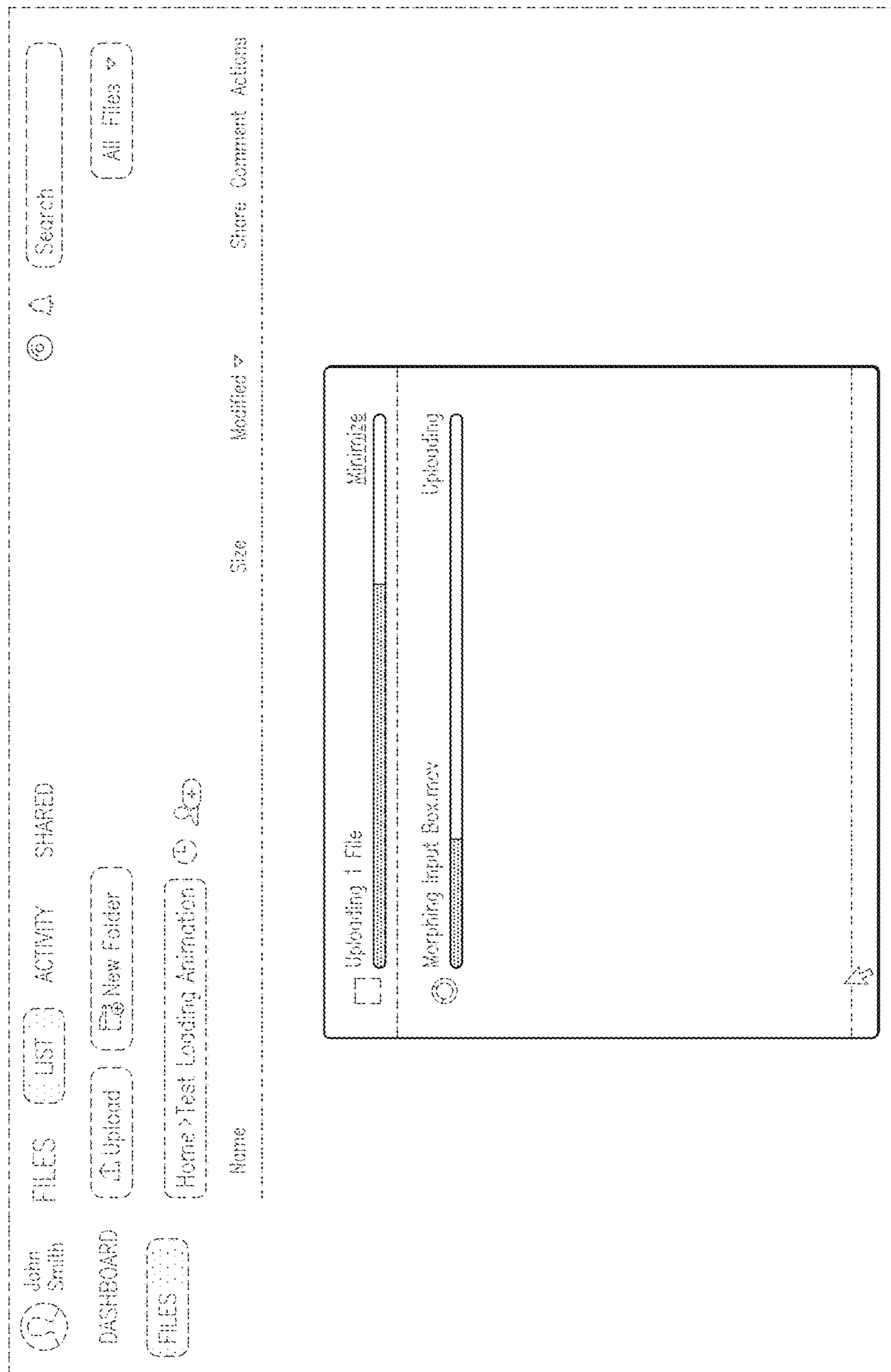


FIG. 22

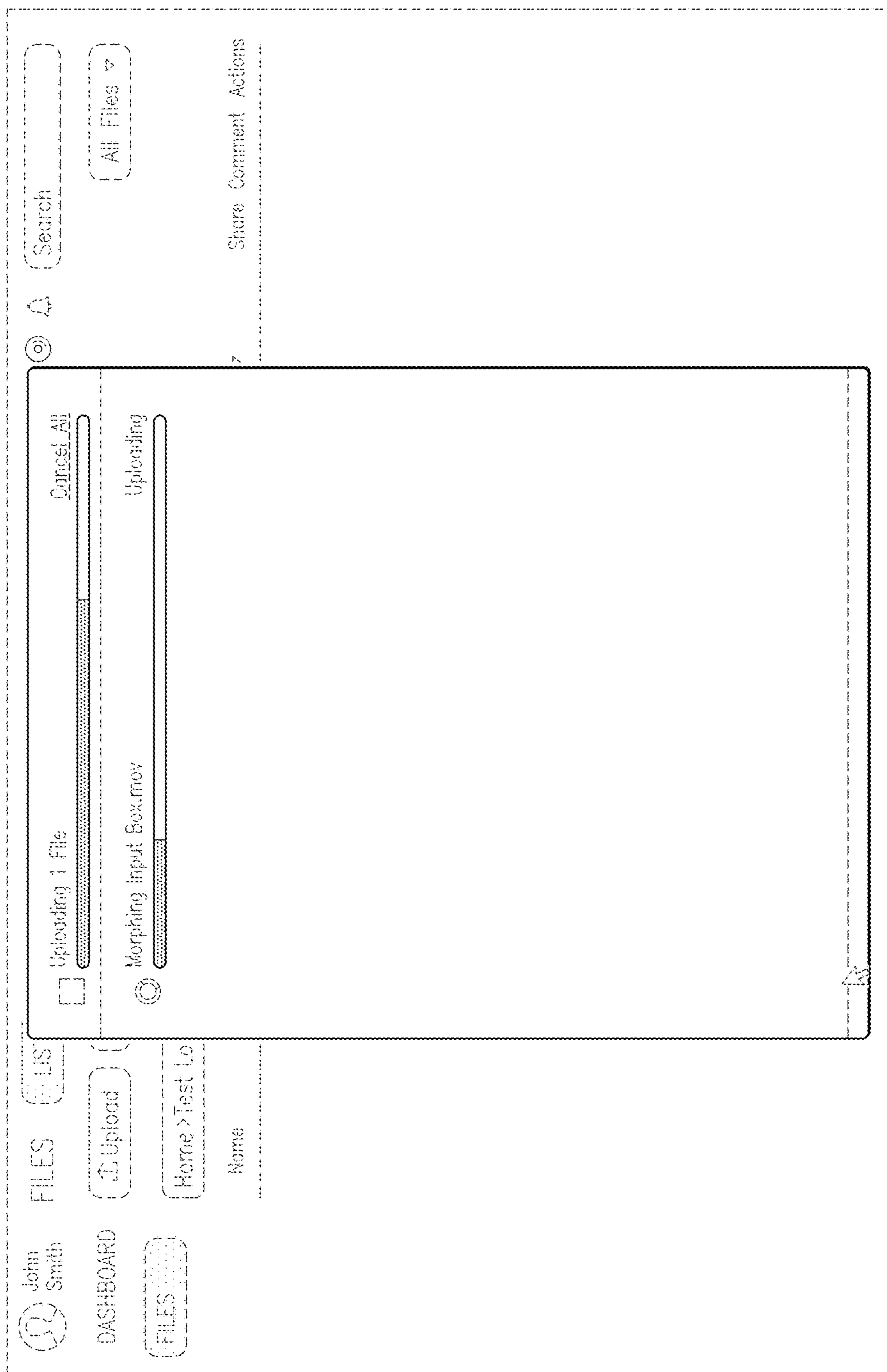


FIG. 23

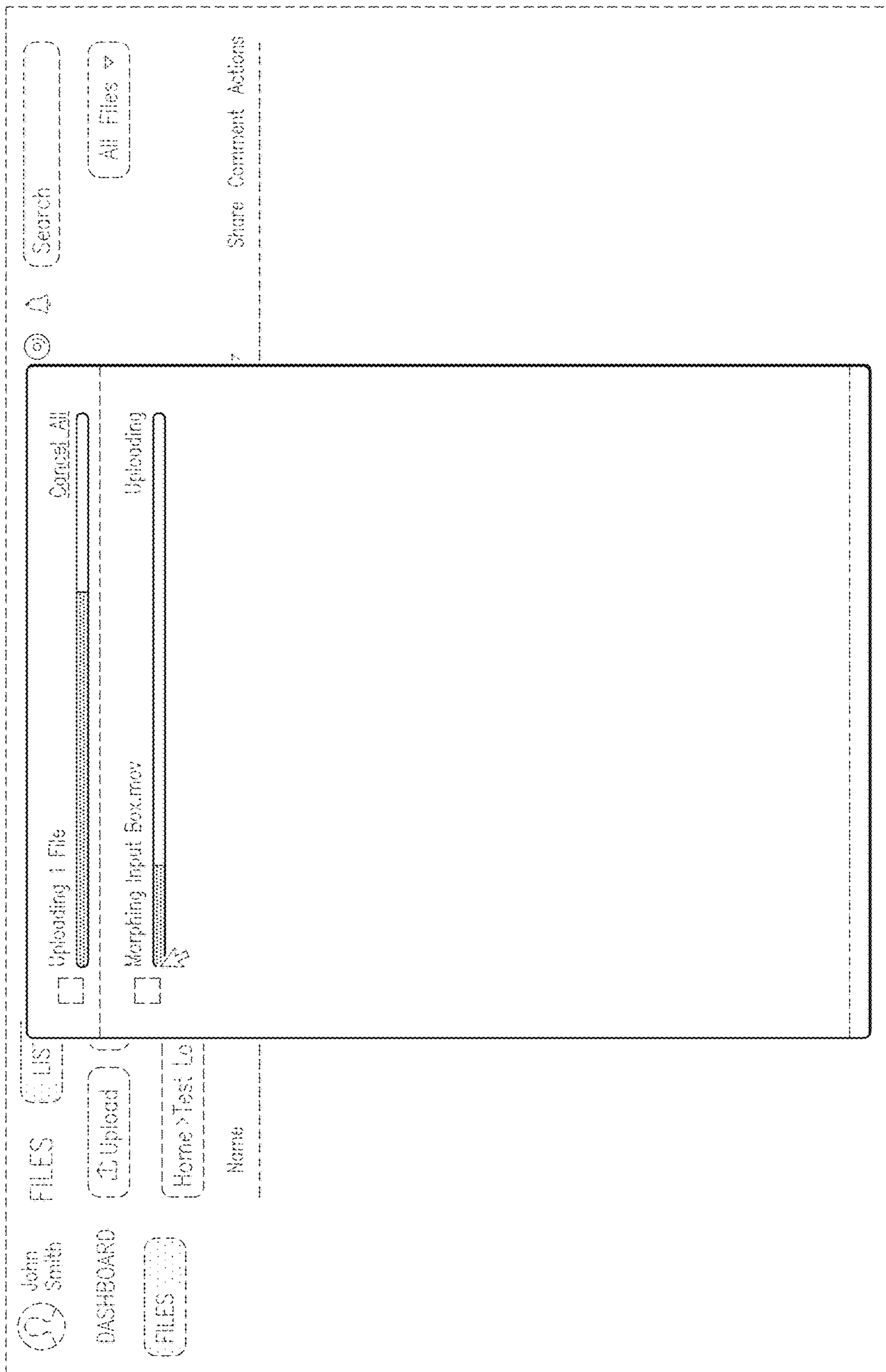


FIG. 24

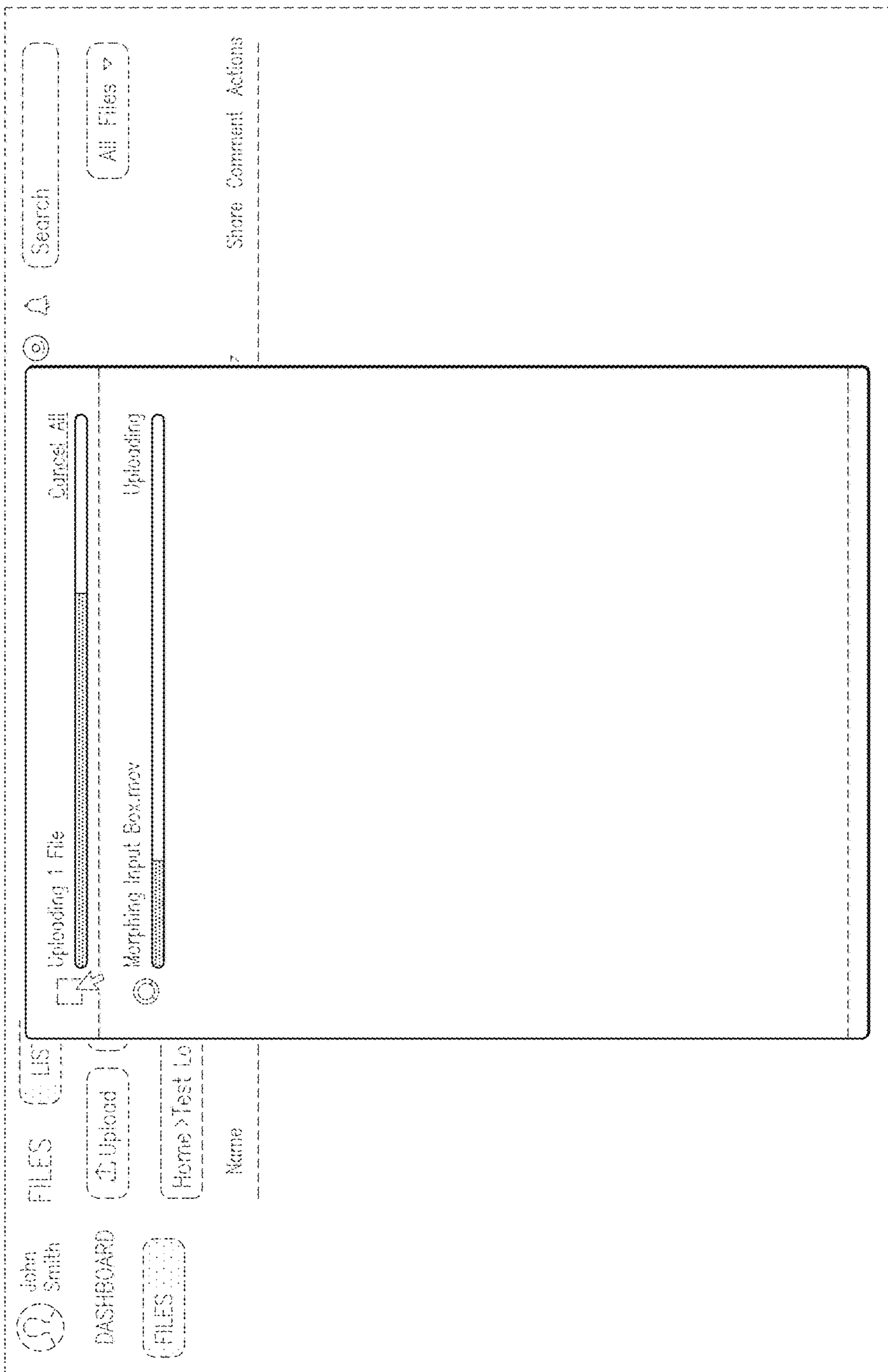


FIG. 25

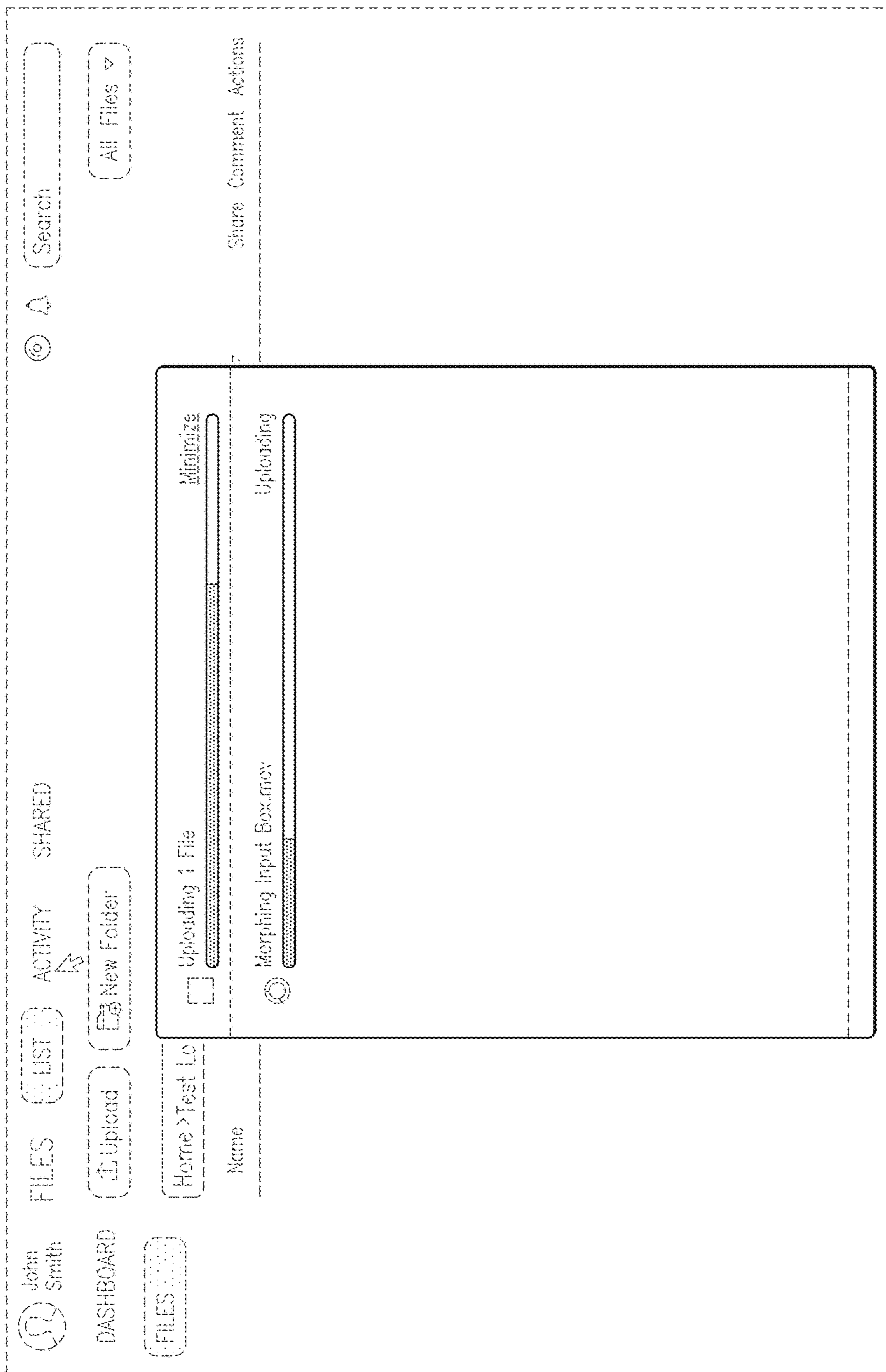


FIG. 26

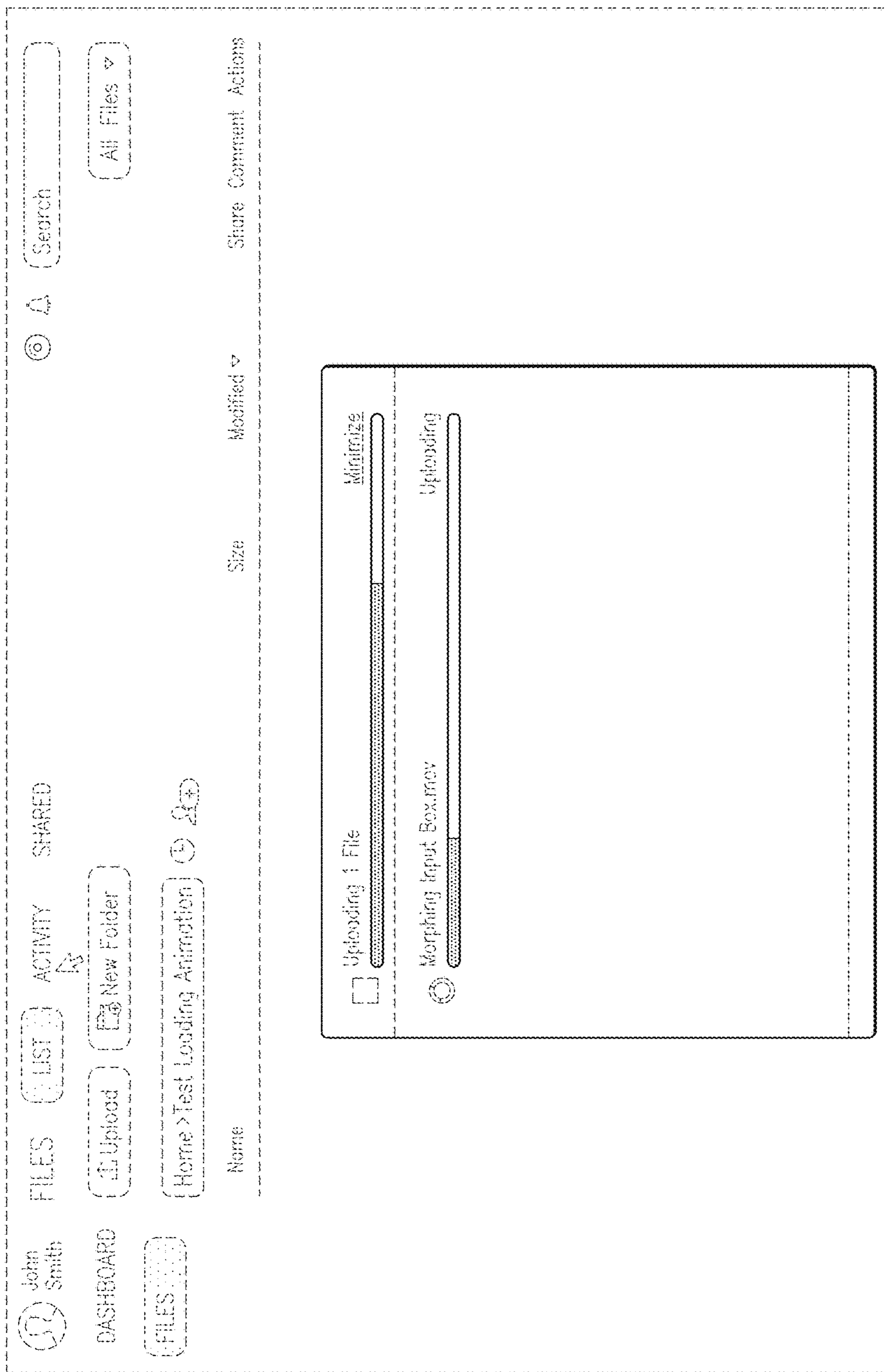


FIG. 27

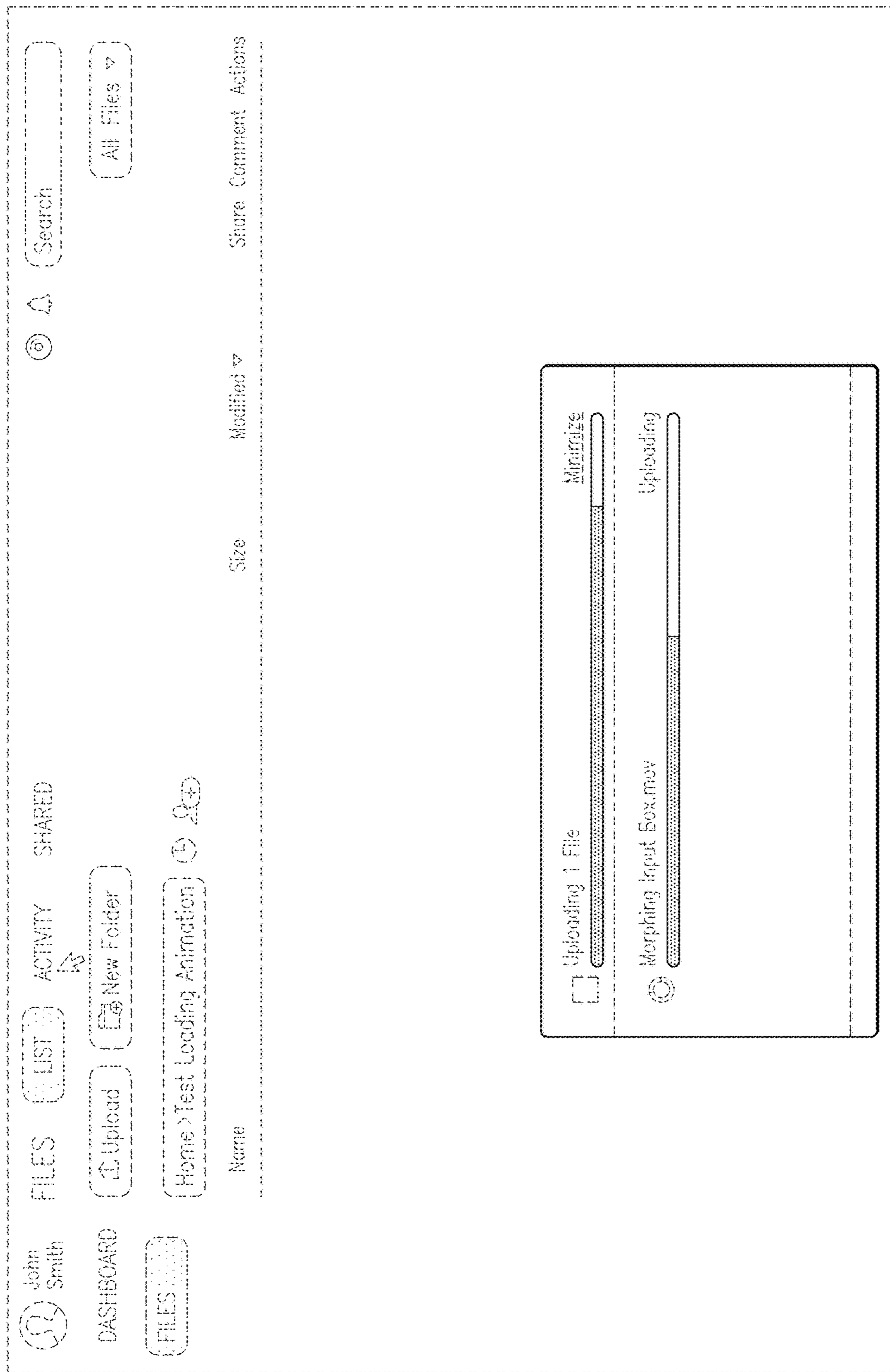


FIG. 28

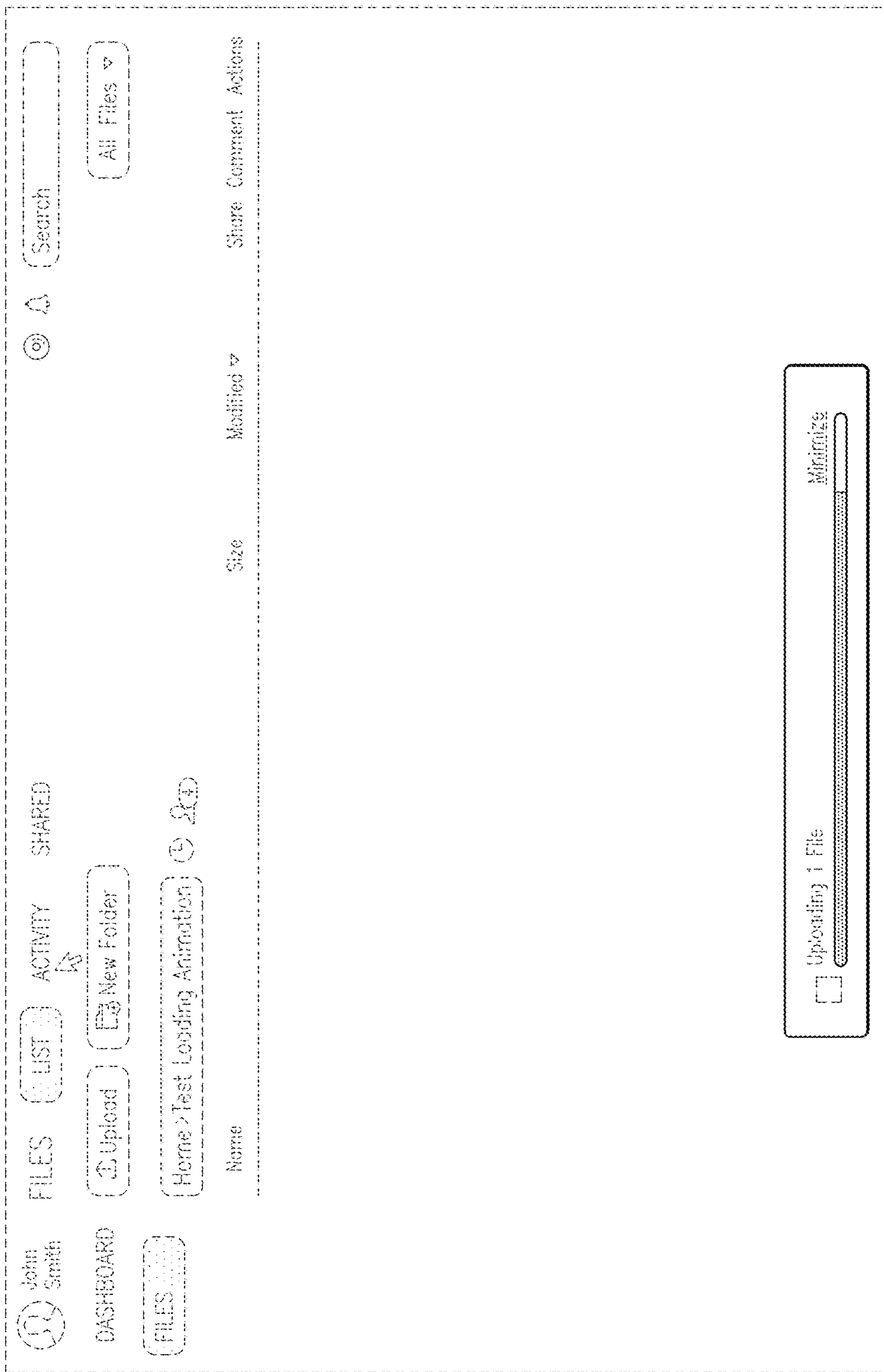


FIG. 29

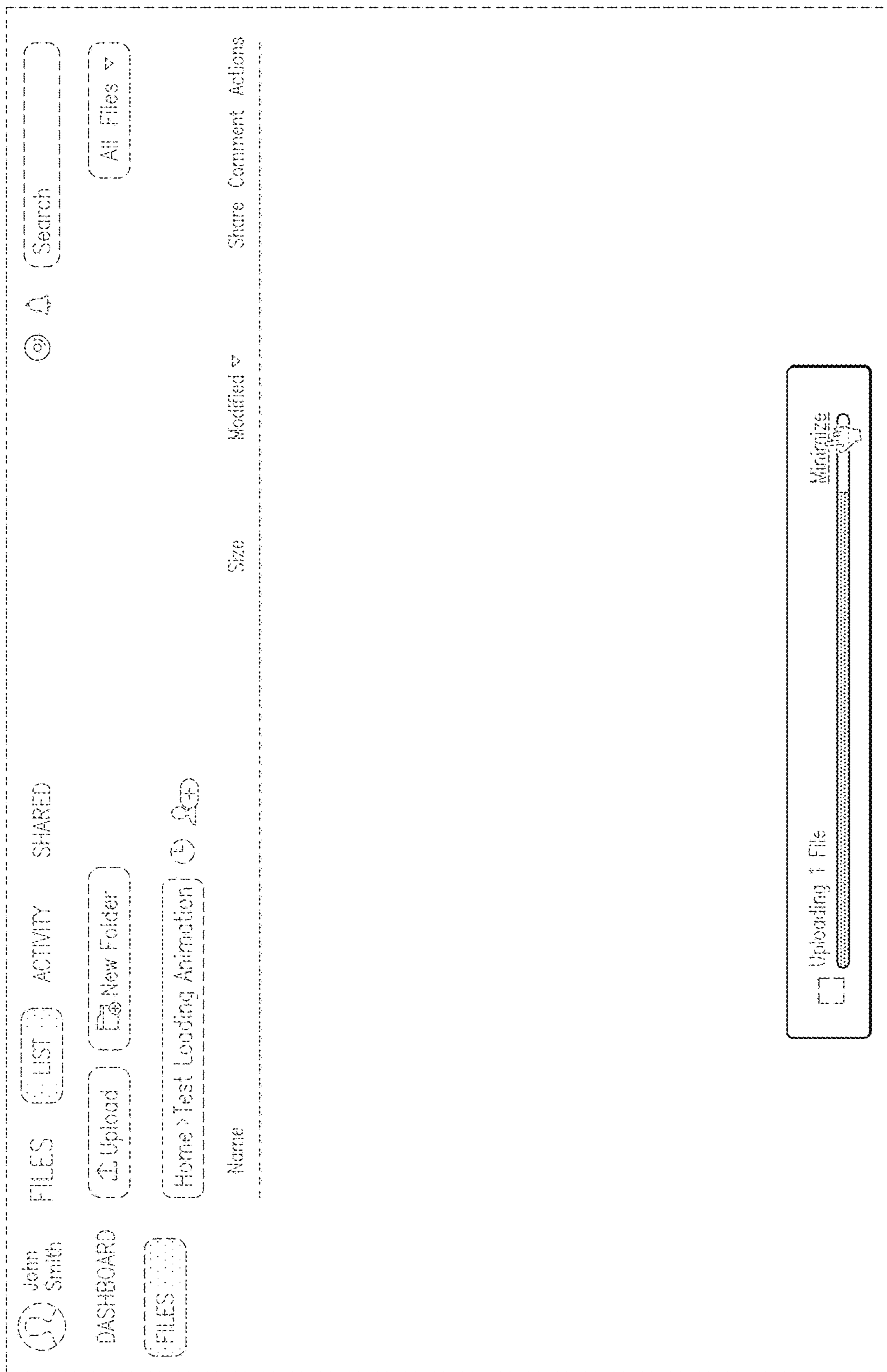


FIG. 30

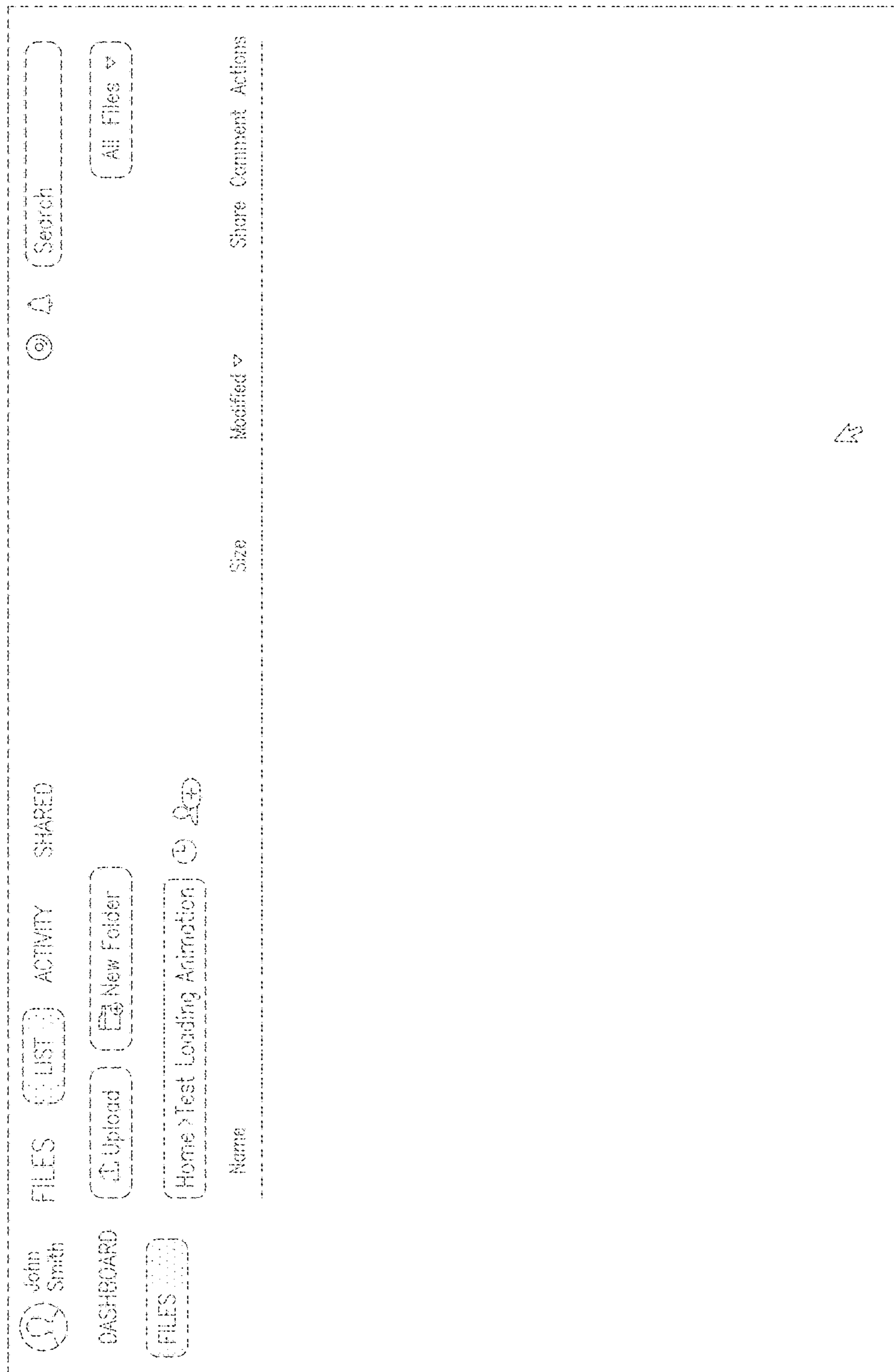


FIG. 31

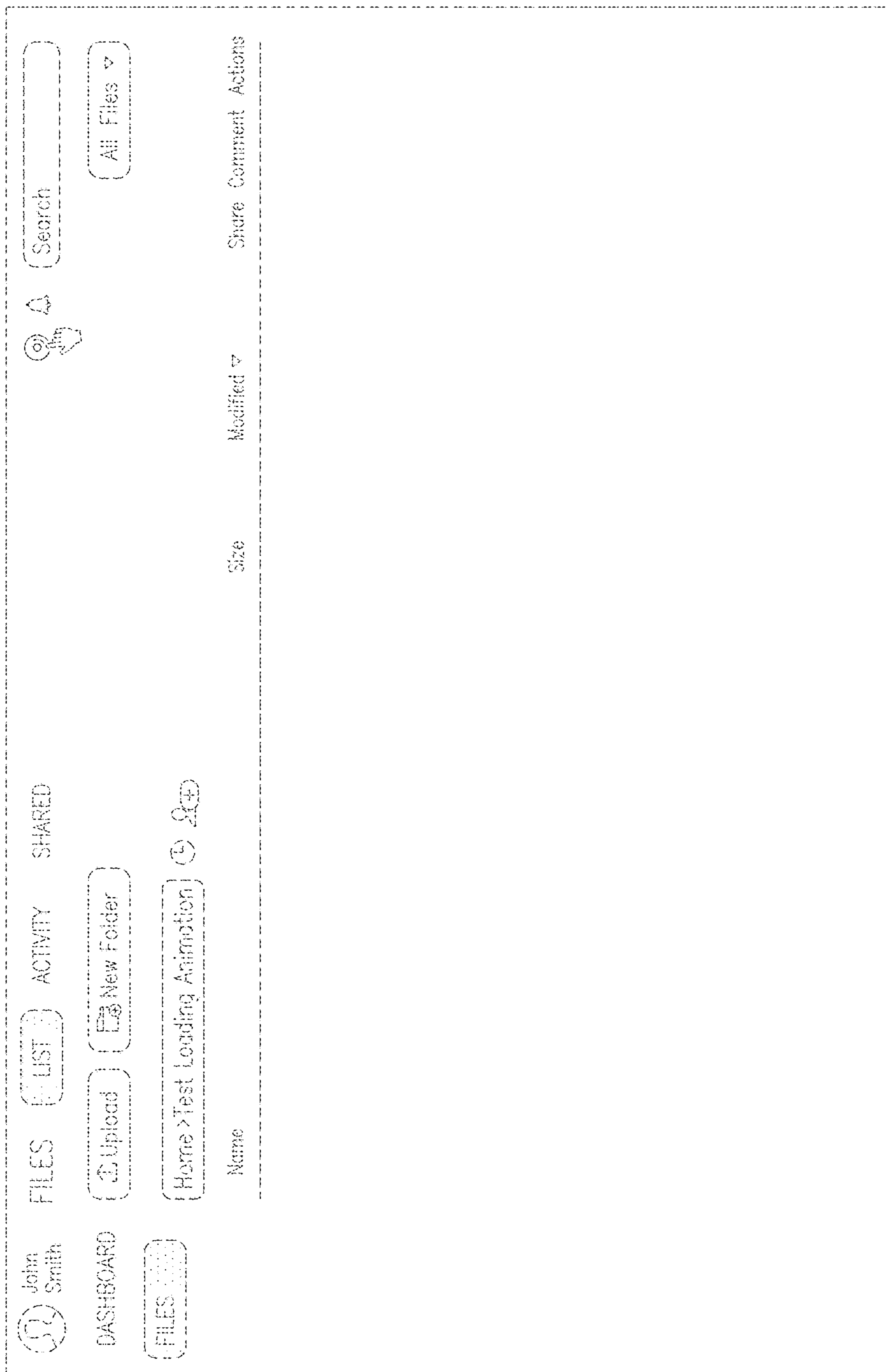


FIG. 32

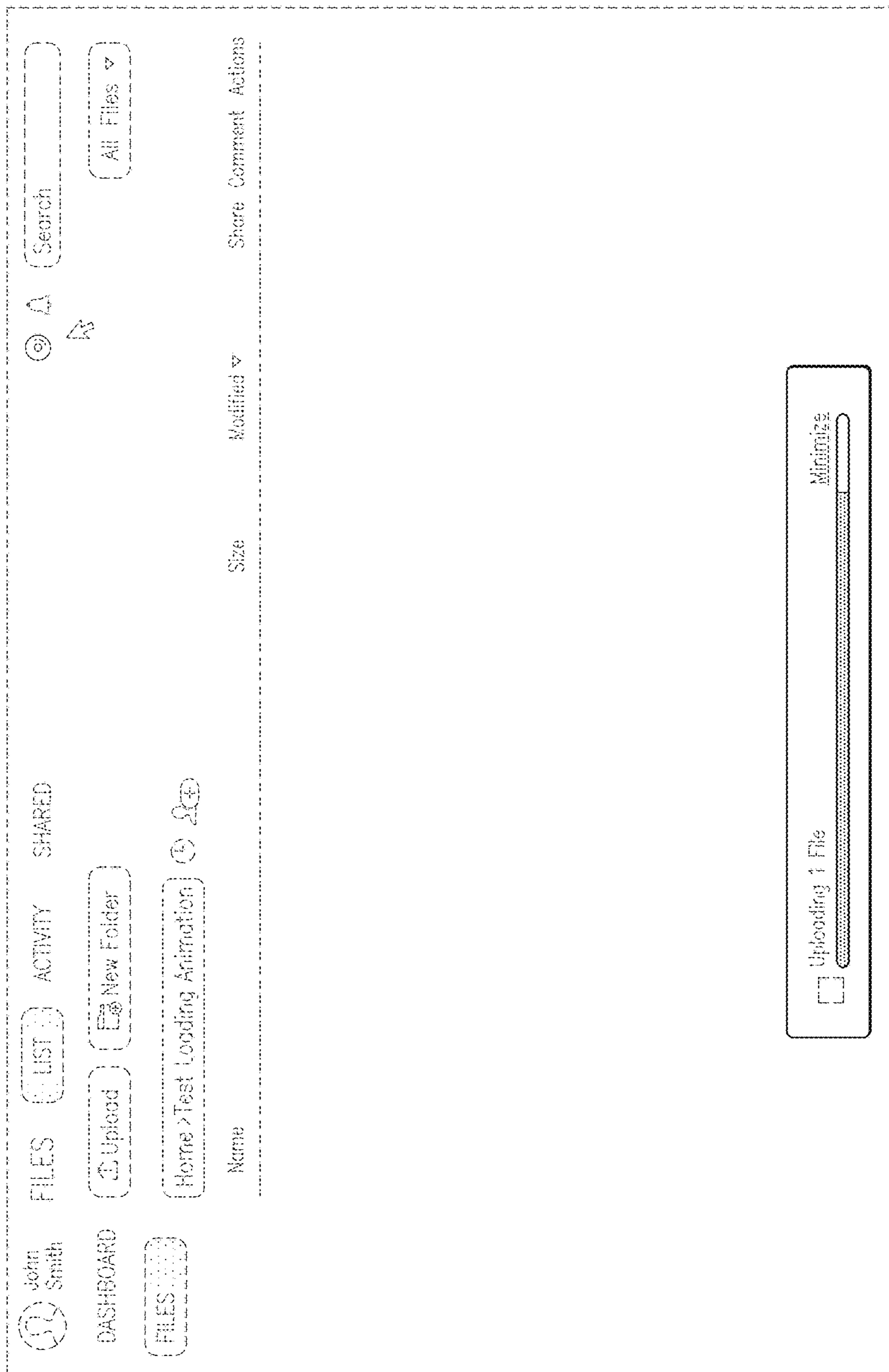


FIG. 33

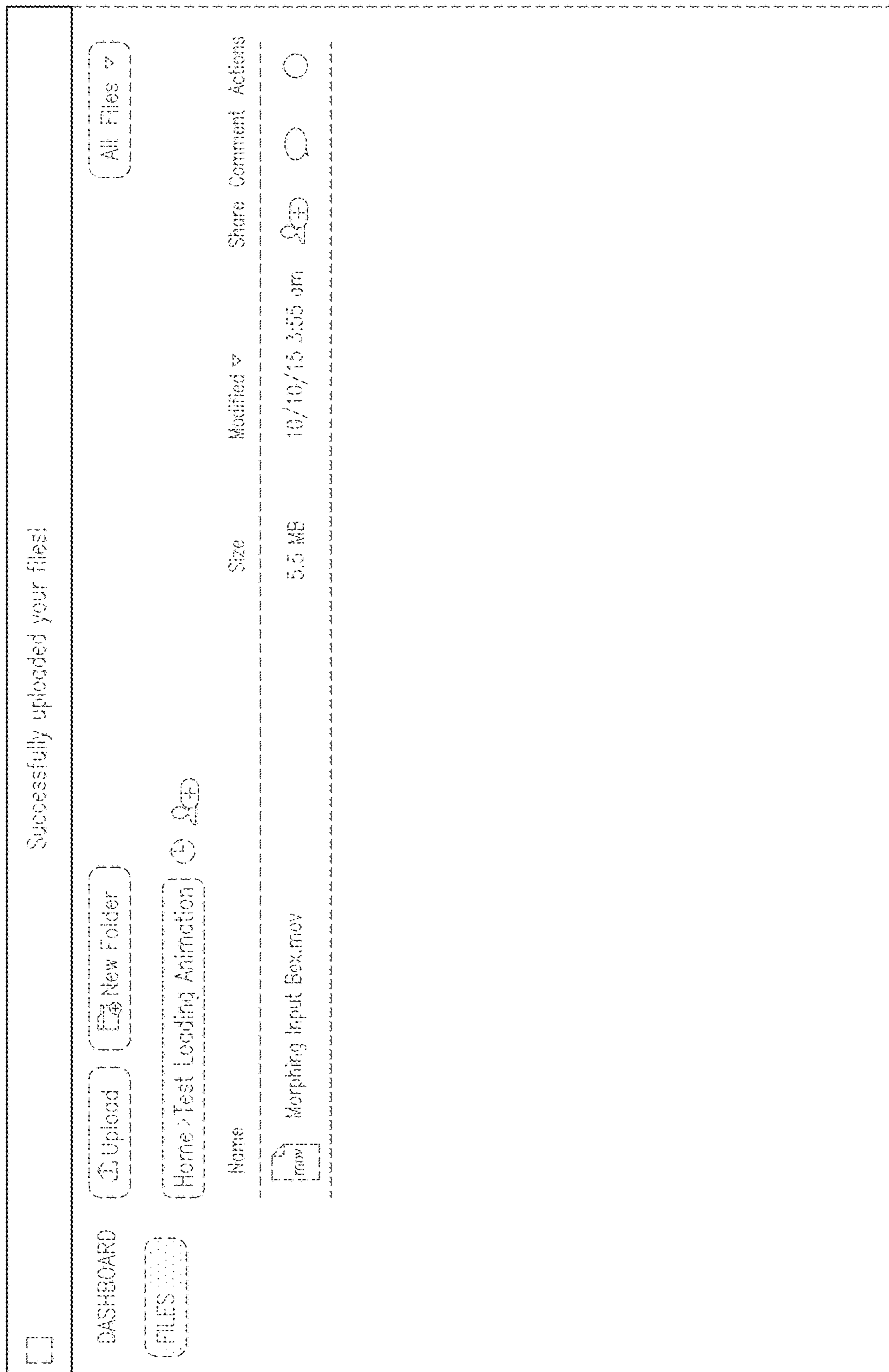


FIG. 34

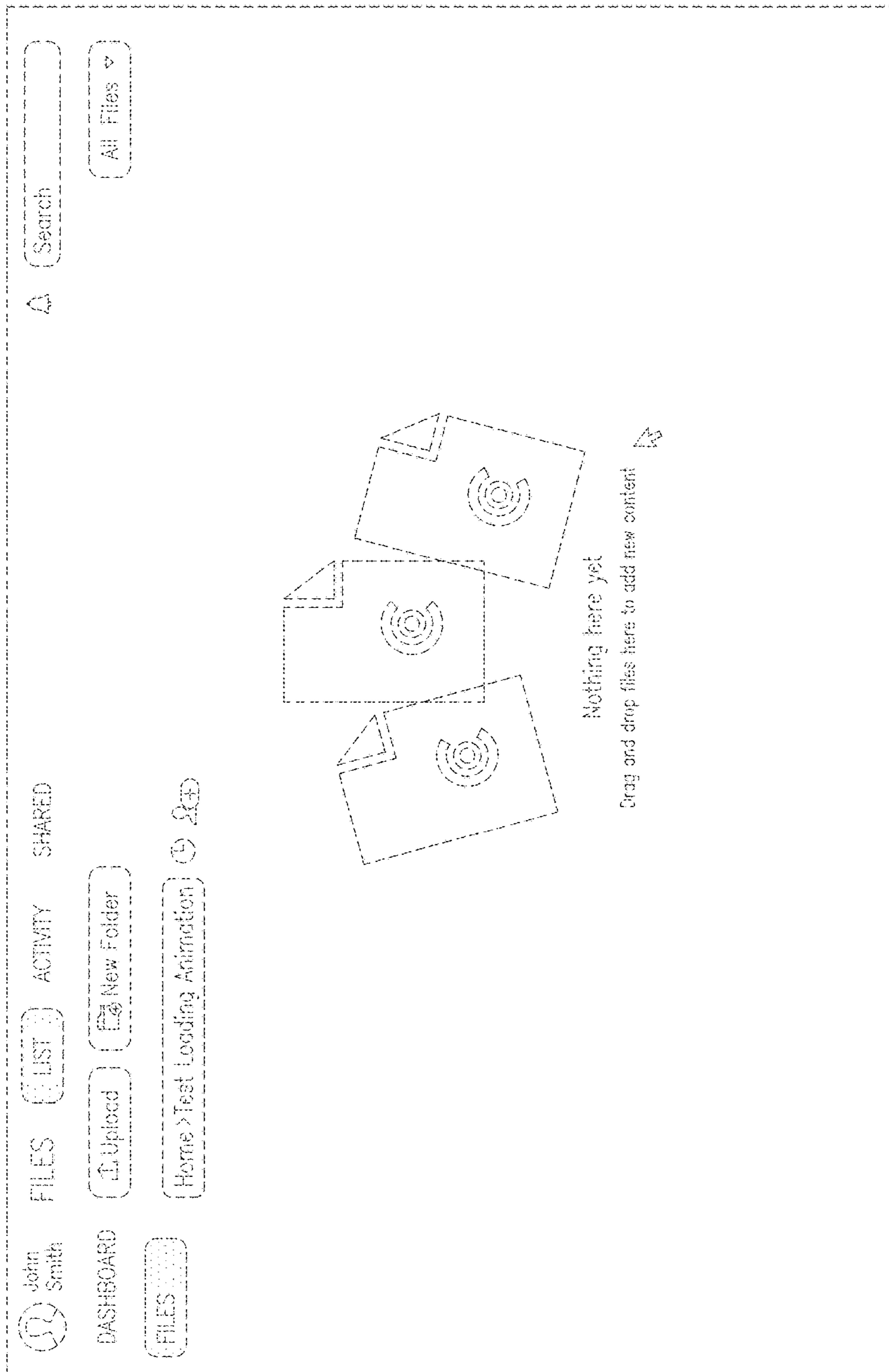


FIG. 35

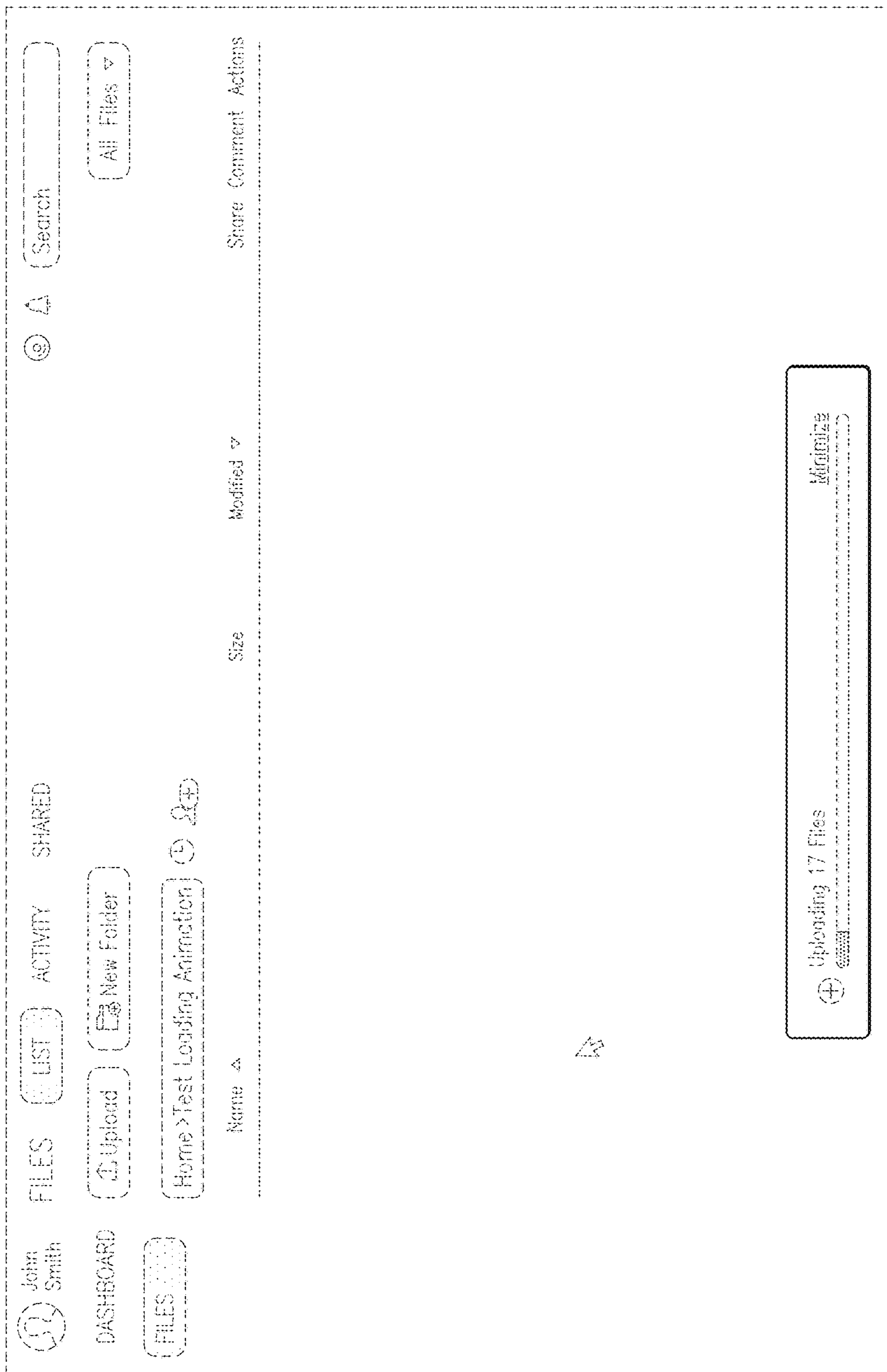


FIG. 37

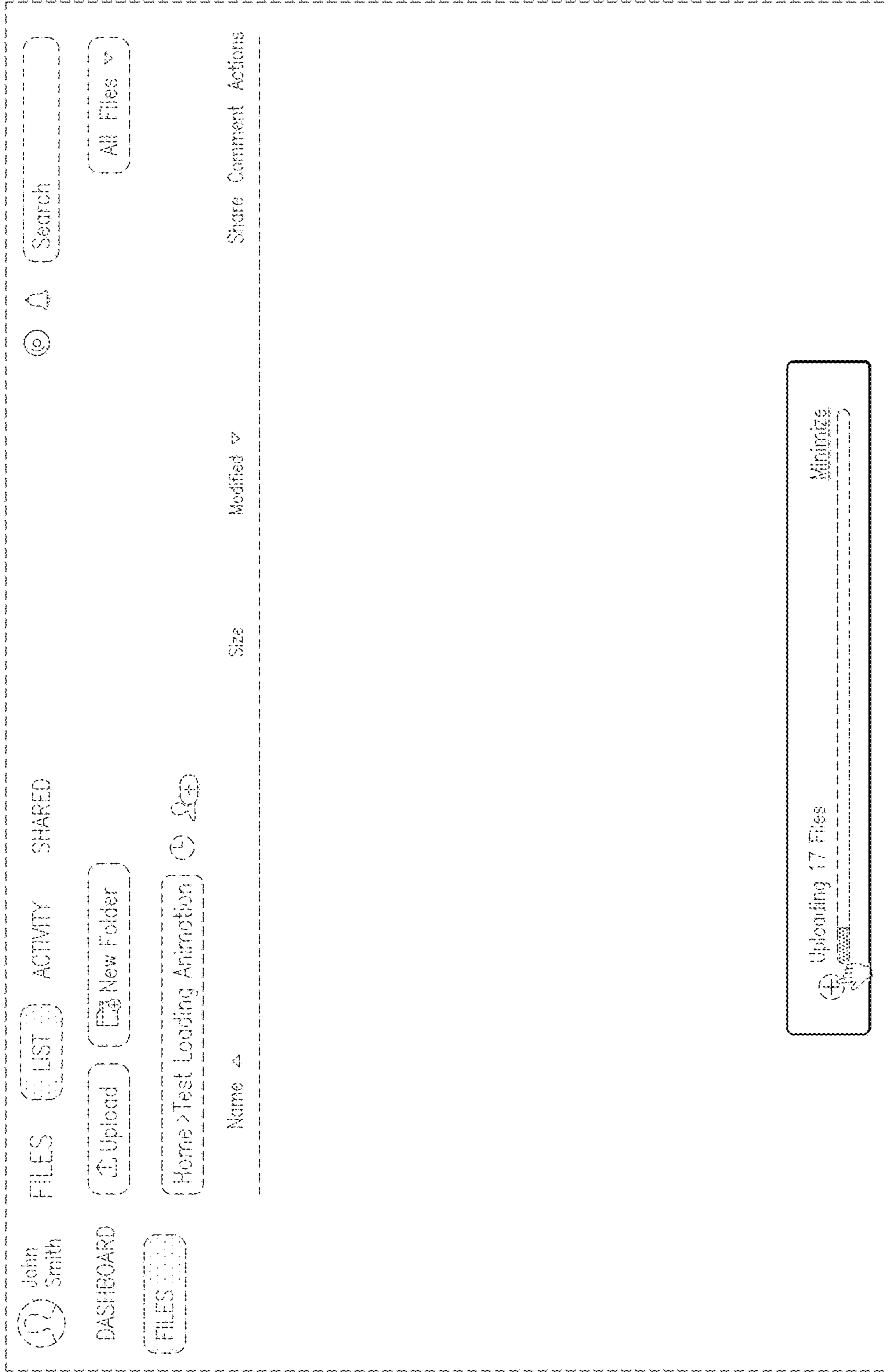


FIG. 38

John Smith

DASHBOARD

FILES

Upload New Folder

Home > Test Loading Animation

Search

All Files

Name	Size	Modified	Share	Comment	Actions
AllowSmooth.jsfl	1 KB	11/04/15 1:25 pm			
AllowSmooth					

Uploading 15 Files
15 Sec remaining

File Name	Size	Status
AllowSmooth.jsfl	1 KB	Done
AllowSmoothOptimizeImages.jsfl	1 KB	Done
control-panel.jpg	265.99 KB	Uploading
Core Marketing Site -- MetaData.docx	90.16 KB	Uploading
Screen Shot 2015-10-21 at 9:46:47...	34.9 KB	Waiting
Screen Shot 2015-10-21 at 10:21:56...	35.95 KB	Waiting
Screen Shot 2015-10-22 at 1:19:32...	659.4 KB	Waiting
Screen Shot 2015-10-23 at 1:28:53...	24.65 KB	Waiting

FIG. 39

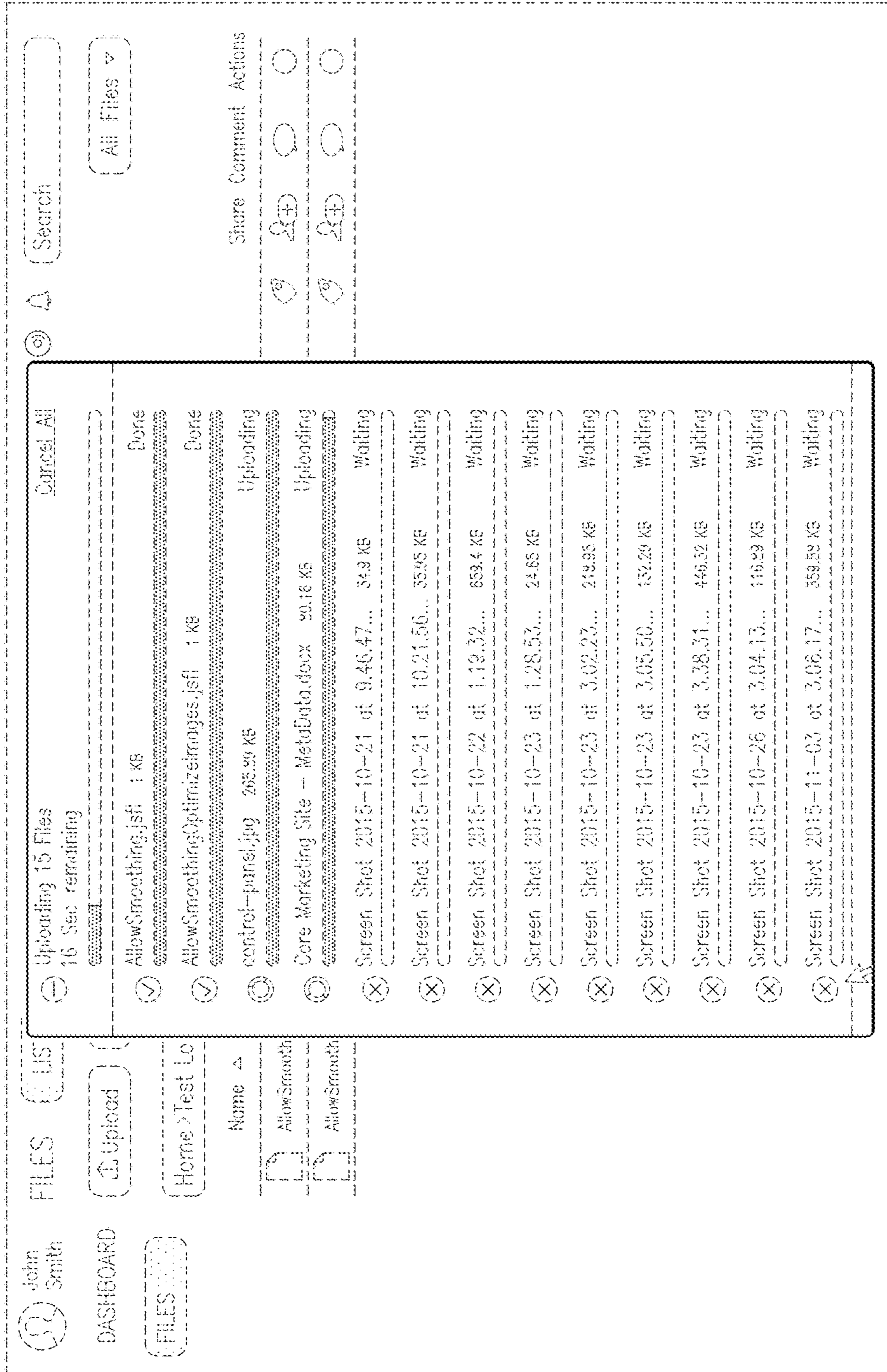


FIG. 40

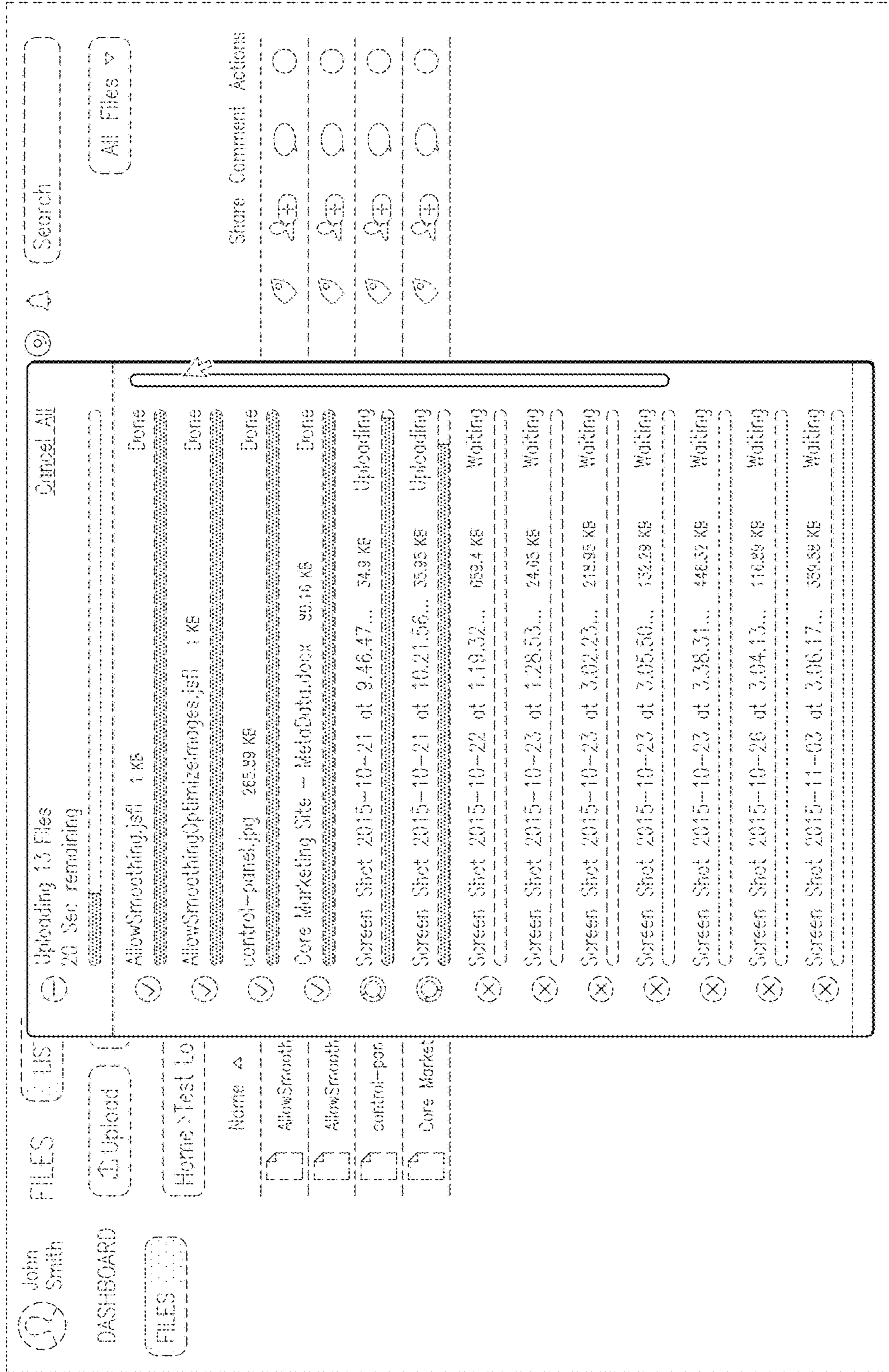


FIG. 41

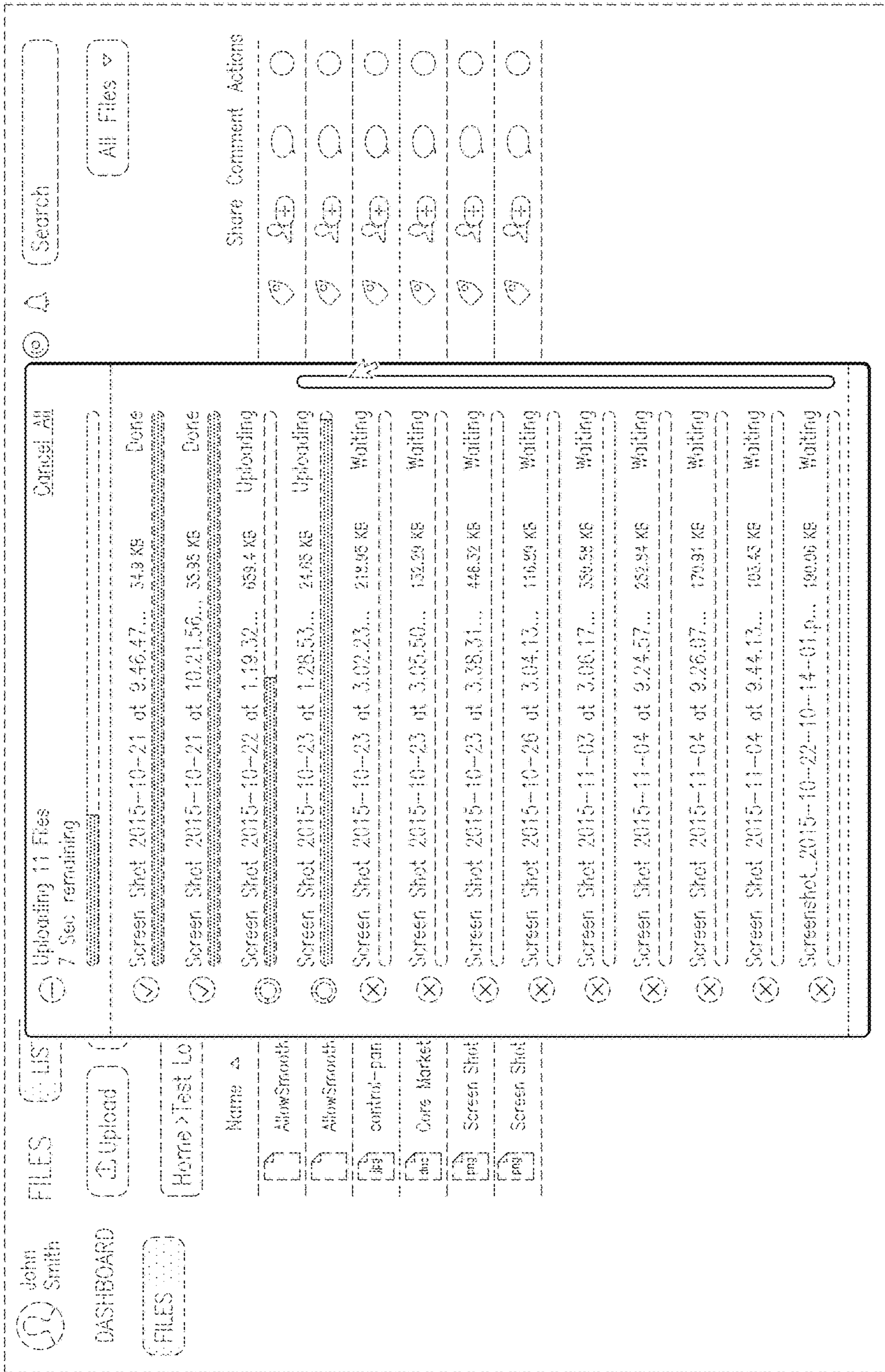


FIG. 42

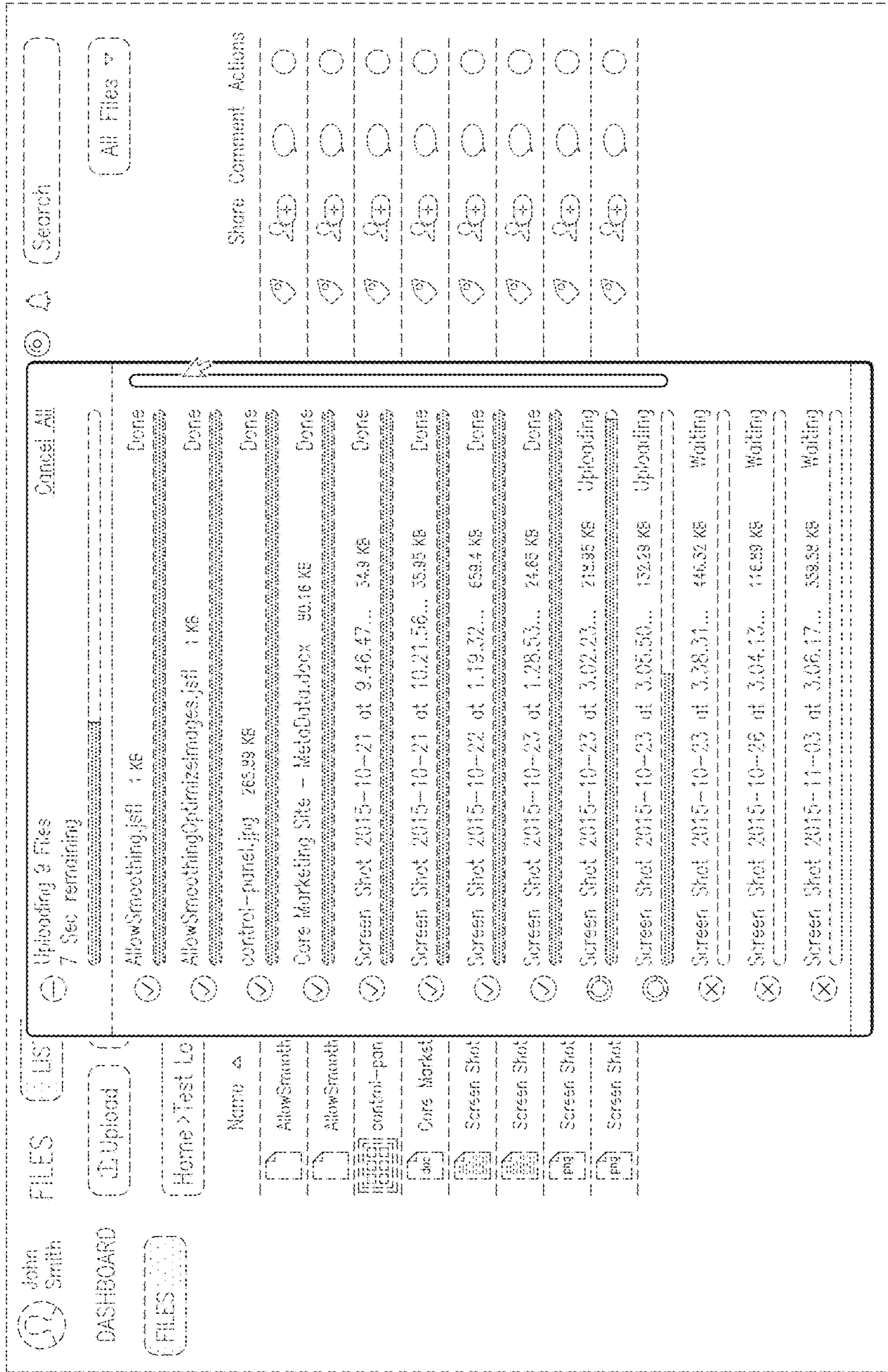


FIG. 43

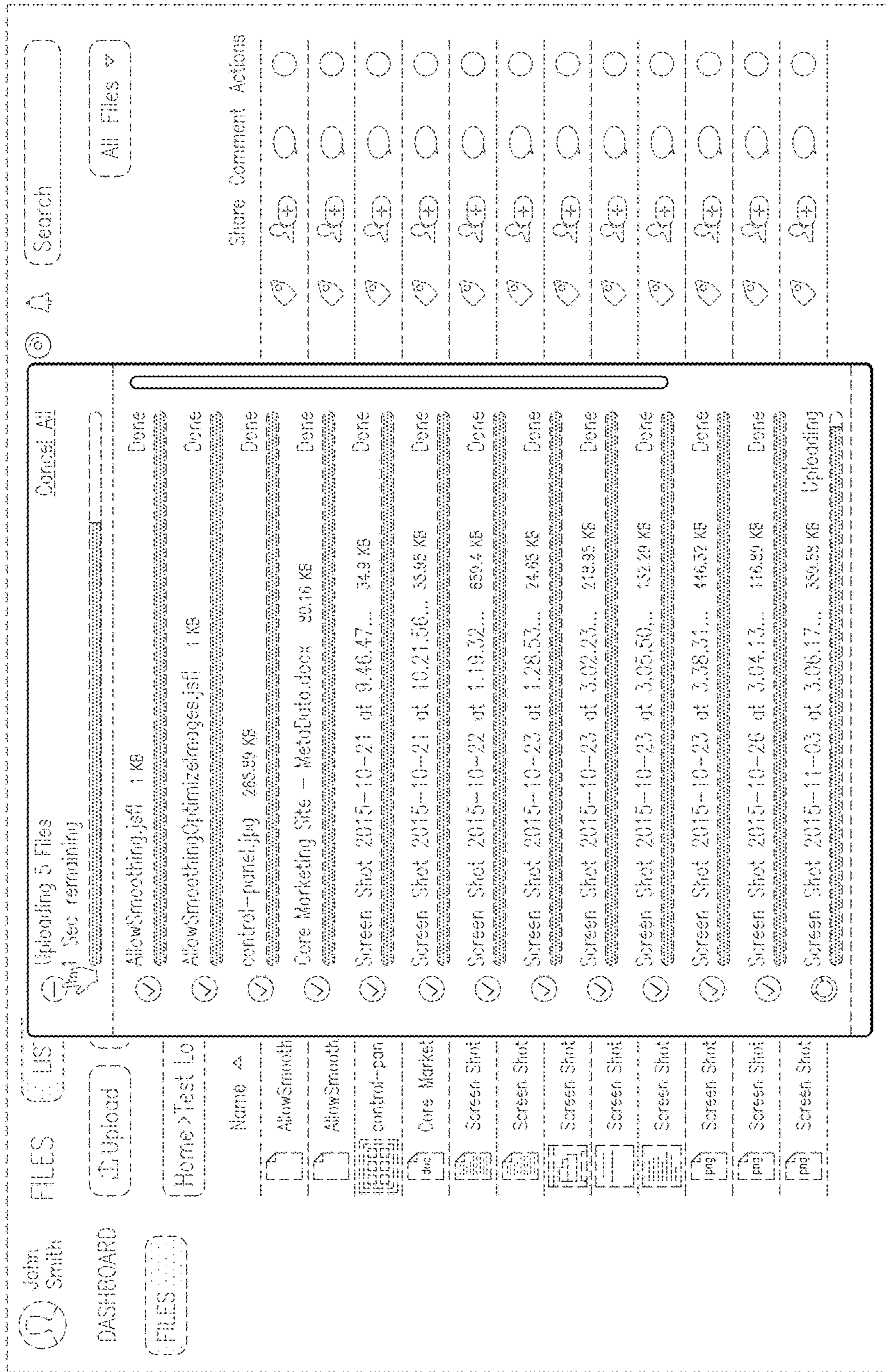


FIG. 44

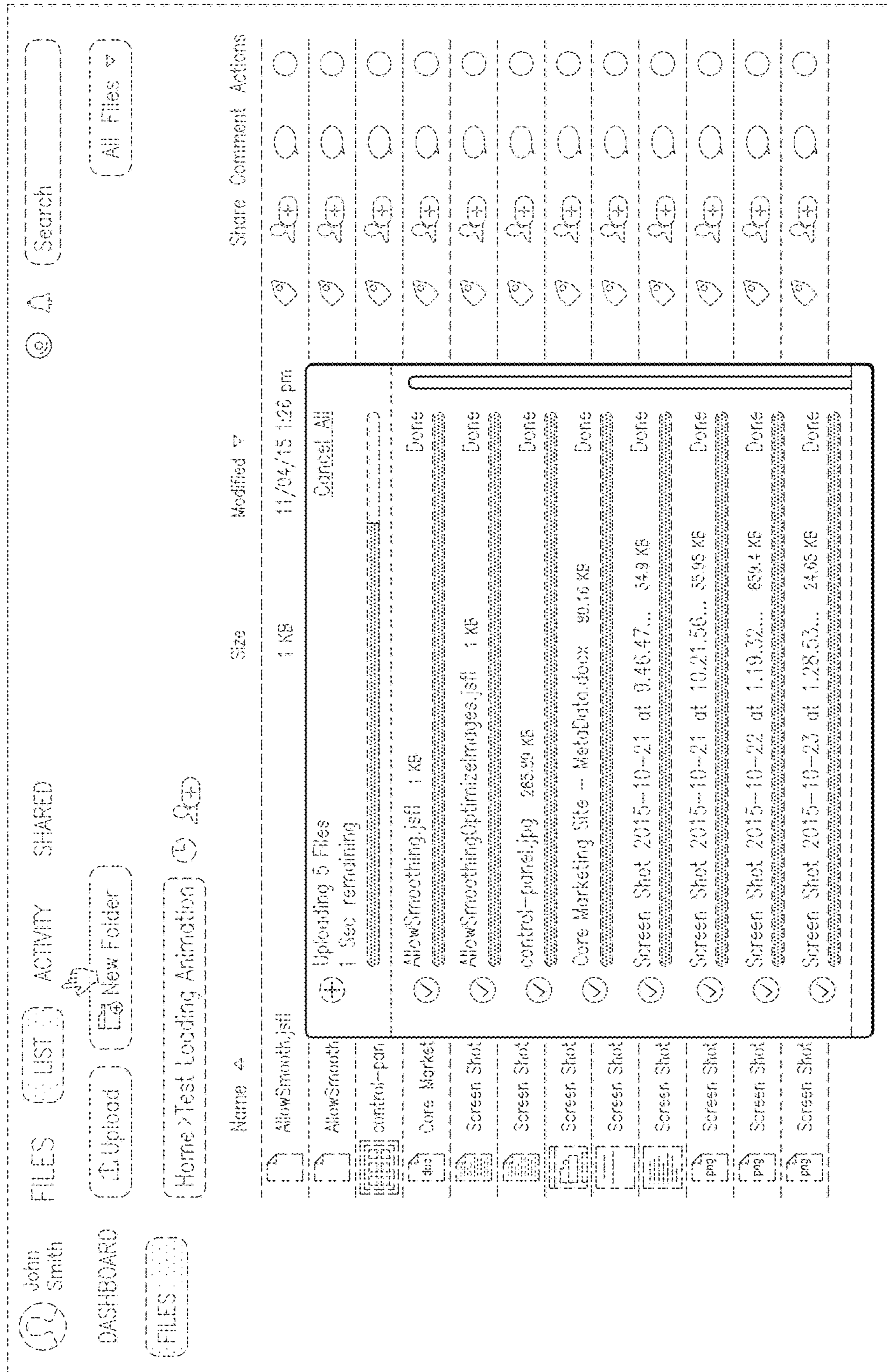


FIG. 45

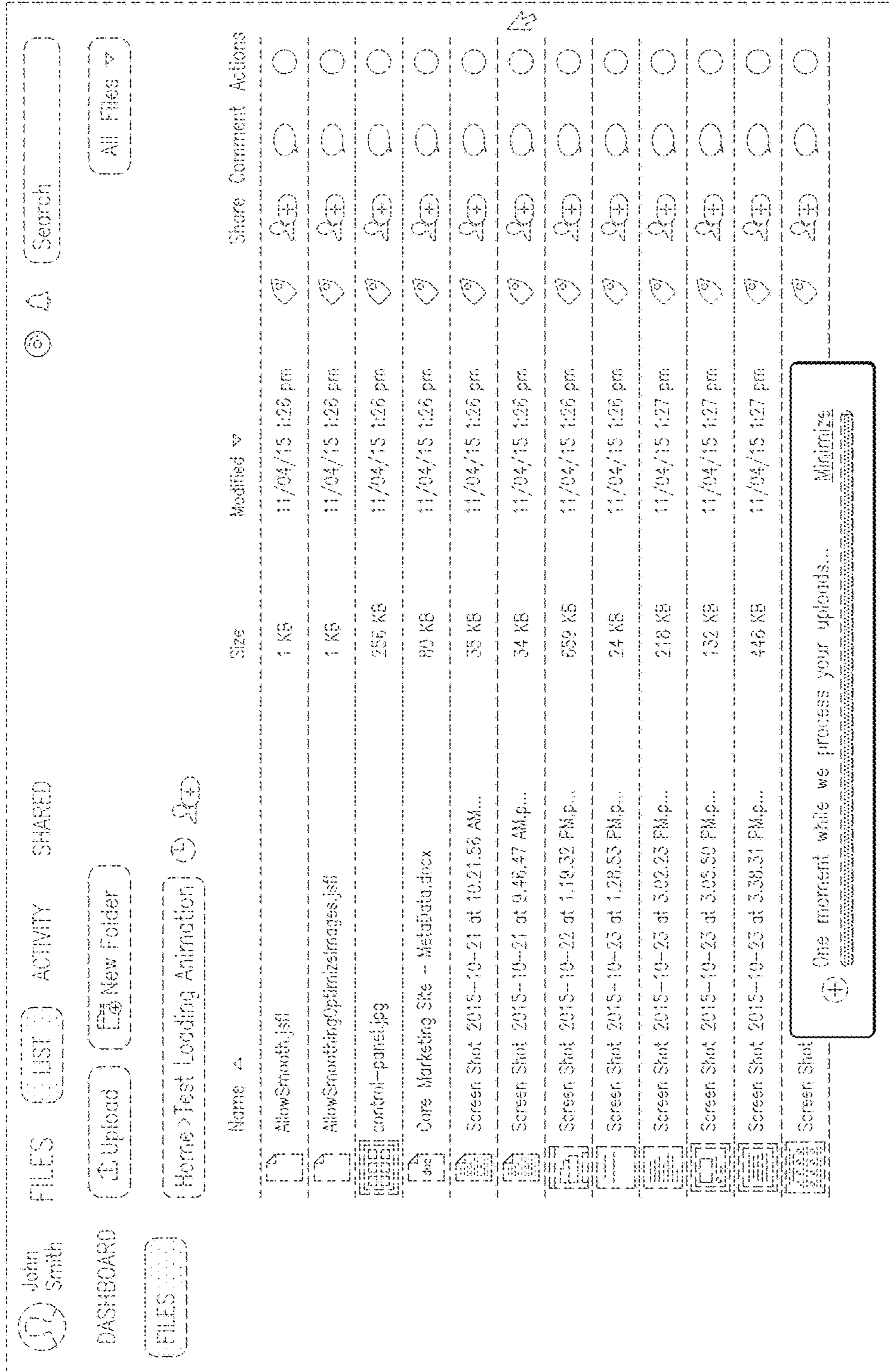


FIG. 46

John Smith

FILES LIST ACTIVITY SHARED

Upload New Folder

Home > Test Loading Animation

Search

All Files

Name	Size	Modified	Share	Comment	Actions
AllowSmooth.jsfif	1 KB	11/04/15 1:26 pm			
AllowSmoothingOptimizeImages.jsfif	1 KB	11/04/15 1:26 pm			
control-panel.jpg	256 KB	11/04/15 1:26 pm			
Core Marketing Site -- MetaData.docx	80 KB	11/04/15 1:26 pm			
Screen Shot 2015-10-21 at 10:21:56 AM...	35 KB	11/04/15 1:26 pm			
Screen Shot 2015-10-21 at 9:46:47 AM.p...	34 KB	11/04/15 1:26 pm			
Screen Shot 2015-10-22 at 1:19:32 PM.p...	659 KB	11/04/15 1:26 pm			
Screen Shot 2015-10-23 at 1:28:53 PM.p...	24 KB	11/04/15 1:26 pm			
Screen Shot 2015-10-23 at 3:02:23 PM.p...	218 KB	11/04/15 1:27 pm			
Screen Shot 2015-10-23 at 3:05:50 PM.p...	152 KB	11/04/15 1:27 pm			
Screen Shot 2015-10-23 at 3:38:31 PM.p...	446 KB	11/04/15 1:27 pm			
Screen Shot					

One moment while we process your uploads... Minimize

FIG. 47

John Smith

FILES LIST ACTIVITY SHARED

DASHBOARD

Upload New Folder

Home > Test Loading Animation

Search

All Files

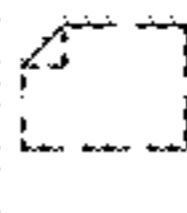
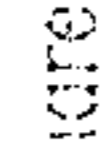



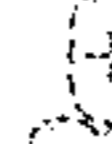
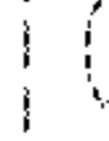
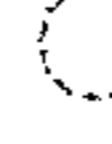
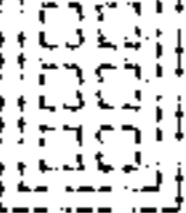
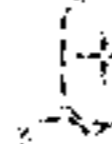
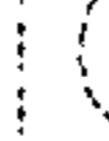

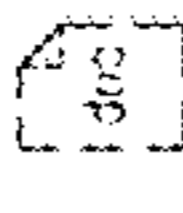
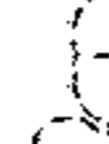
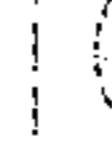


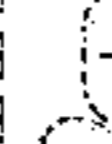
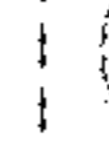
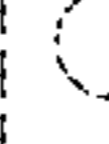

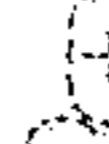
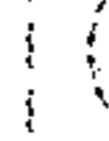
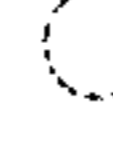
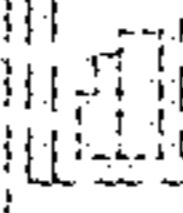
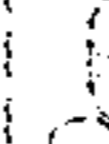
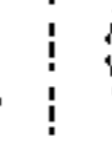
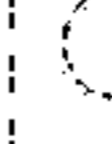
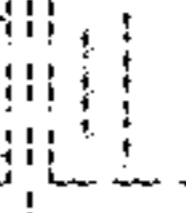
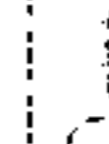
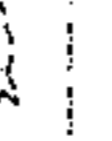

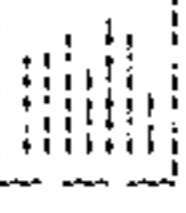
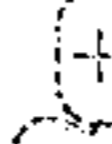
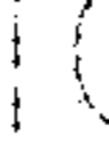


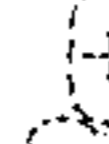
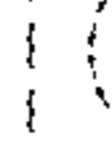
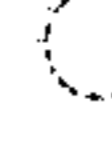

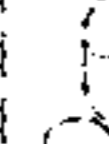
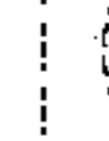
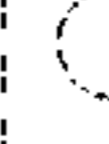
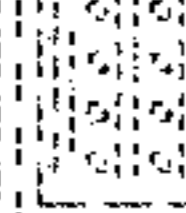
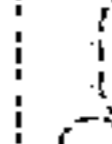
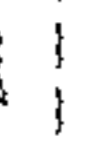
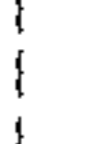
Name	Size	Modified	Share	Comment	Actions
 AllowSmooth.jsft	1 KB	11/04/15 1:26 pm			
 AllowSmoothingOptimizImages.jsft	1 KB	11/04/15 1:26 pm			
 control--parsi.jpg	256 KB	11/04/15 1:26 pm			
 Core Marketing Site - MetaData.docx	80 KB	11/04/15 1:26 pm			
 Screen Shot 2015-10-21 at 10:21:56 AM...	35 KB	11/04/15 1:26 pm			
 Screen Shot 2015-10-21 at 9:46:47 AM.p...	34 KB	11/04/15 1:26 pm			
 Screen Shot 2015-10-22 at 1:19:32 PM.p...	659 KB	11/04/15 1:26 pm			
 Screen Shot 2015-10-23 at 1:28:53 PM.p...	24 KB	11/04/15 1:26 pm			
 Screen Shot 2015-10-23 at 3:02:23 PM.p...	218 KB	11/04/15 1:27 pm			
 Screen Shot 2015-10-23 at 3:05:50 PM.p...	132 KB	11/04/15 1:27 pm			
 Screen Shot 2015-10-23 at 3:38:31 PM.p...	446 KB	11/04/15 1:27 pm			
 Screen Shot 2015-10-26 at 3:04:13 PM.p...	116 KB	11/04/15 1:27 pm			

FIG. 48

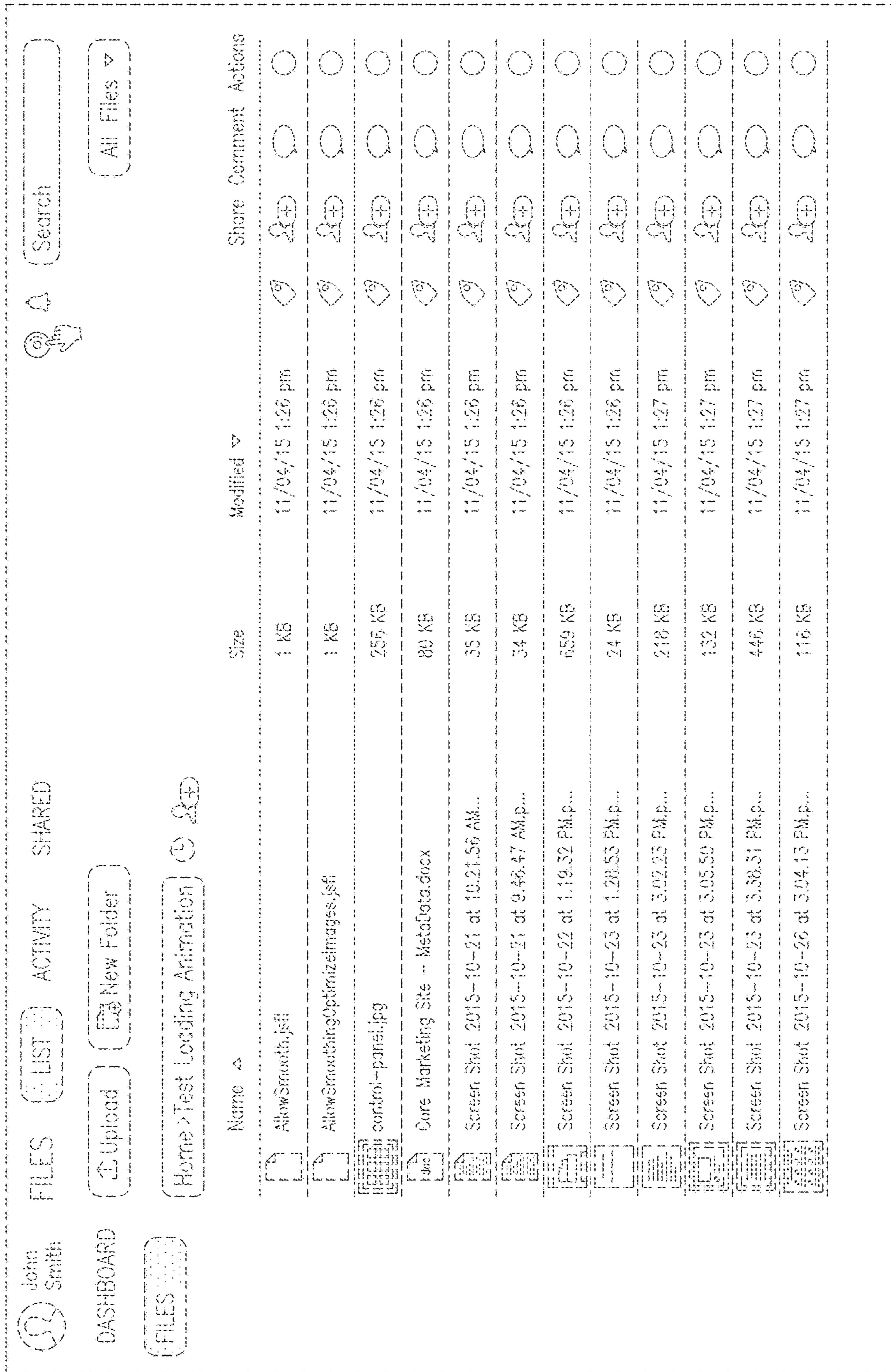


FIG. 49

John Smith

FILES LIST ACTIVITY SHARED

DASHBOARD

Upload New Folder

Home > Test Loading Animation

Search

All Files

Name	Size	Modified	Share	Comment	Actions
AllowSmooth.jsf	1 KB	11/04/15 1:26 pm			
AllowSmoothingOptimizeImages.jsf	1 KB	11/04/15 1:26 pm			
control-panel.jpg	256 KB	11/04/15 1:26 pm			
Cors Marketing Site - Metadata.docx	80 KB	11/04/15 1:26 pm			
Screen Shot 2015-10-21 at 10:21:56 AM...	35 KB	11/04/15 1:26 pm			
Screen Shot 2015-10-21 at 9:46:47 AM.p...	34 KB	11/04/15 1:26 pm			
Screen Shot 2015-10-22 at 1:19:32 PM.p...	659 KB	11/04/15 1:26 pm			
Screen Shot 2015-10-23 at 1:28:53 PM.p...	24 KB	11/04/15 1:26 pm			
Screen Shot 2015-10-23 at 3:02:23 PM.p...	218 KB	11/04/15 1:27 pm			
Screen Shot 2015-10-23 at 3:05:50 PM.p...	132 KB	11/04/15 1:27 pm			
Screen Shot 2015-10-23 at 3:38:31 PM.p...	446 KB	11/04/15 1:27 pm			
Screen Shot					

One moment while we process your uploads... Minimize

FIG. 50

× Successfully uploaded your files!

DASHBOARD [Upload] [New Folder] [All Files ▾]

[FILES (10)] [Home > Test Loading Animation] [Refresh] [Share]







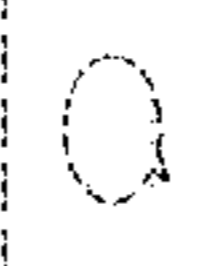

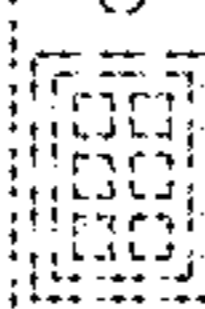
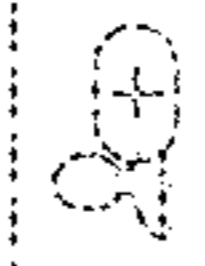
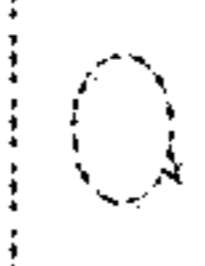
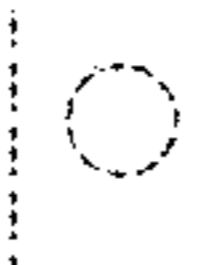
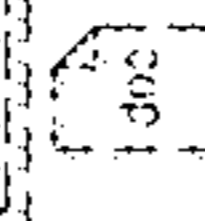
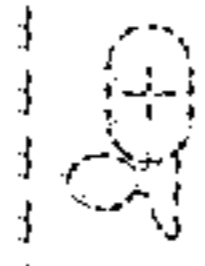
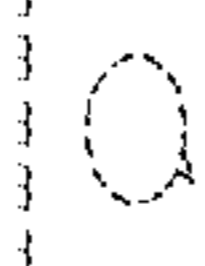
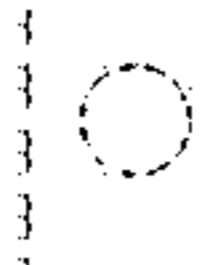
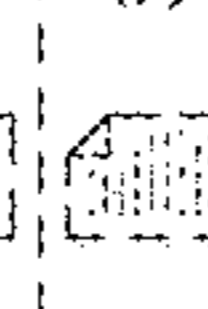

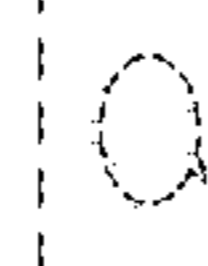

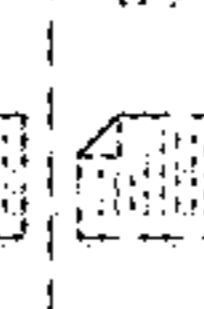
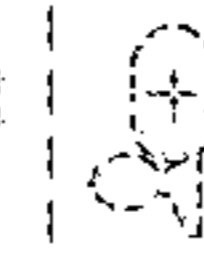
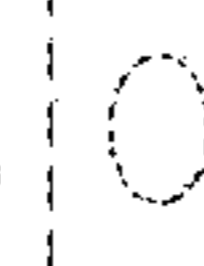
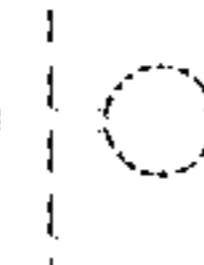


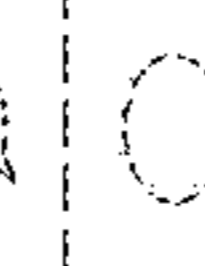

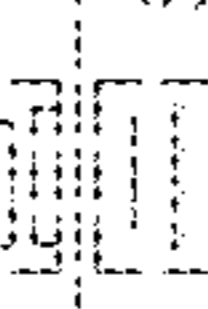

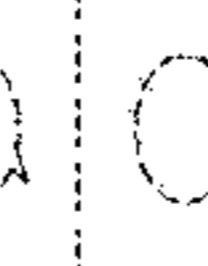
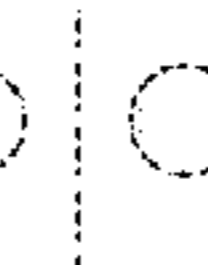
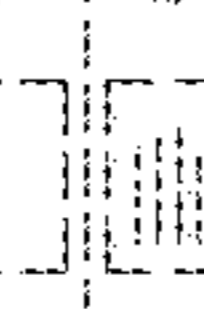
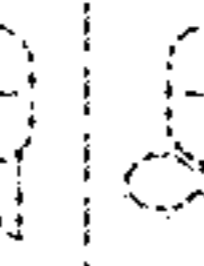
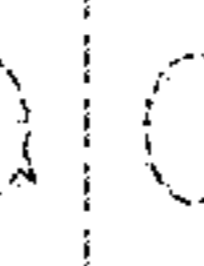
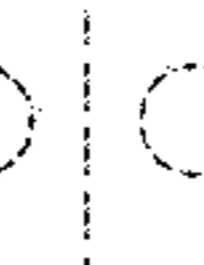




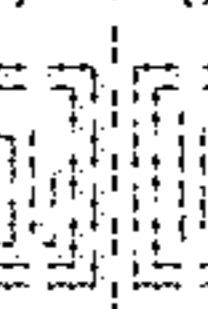
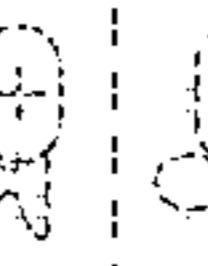
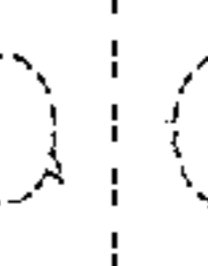
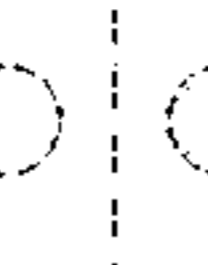
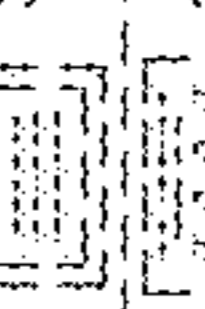

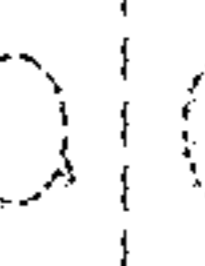

Name ▲	Size	Modified ▾	Share	Comment	Actions
 AllowSmooth.jsf	1 KB	11/04/15 1:26 pm			
 AllowSmoothingOptimizeImages.jsf	1 KB	11/04/15 1:26 pm			
 control-panel.jpg	256 KB	11/04/15 1:26 pm			
 Core Marketing Site -- MetaData.docx	80 KB	11/04/15 1:26 pm			
 Screen Shot 2015-10-21 at 10:21:56 AM...	35 KB	11/04/15 1:26 pm			
 Screen Shot 2015-10-21 at 9:46:47 AM...	34 KB	11/04/15 1:26 pm			
 Screen Shot 2015-10-22 at 1:19:32 PM...	659 KB	11/04/15 1:26 pm			
 Screen Shot 2015-10-23 at 1:28:53 PM...	24 KB	11/04/15 1:26 pm			
 Screen Shot 2015-10-23 at 3:02:23 PM...	218 KB	11/04/15 1:27 pm			
 Screen Shot 2015-10-23 at 3:05:50 PM...	132 KB	11/04/15 1:27 pm			
 Screen Shot 2015-10-23 at 3:38:51 PM...	446 KB	11/04/15 1:27 pm			
 Screen Shot 2015-10-26 at 3:04:15 PM...	116 KB	11/04/15 1:27 pm			

FIG. 51