



US00D802583S

(12) **United States Design Patent**
Oakley et al.

(10) **Patent No.:** **US D802,583 S**

(45) **Date of Patent:** **** Nov. 14, 2017**

(54) **NOTEBOOK COMPUTER**

(71) Applicant: **Intel Corporation**, Santa Clara, CA
(US)

(72) Inventors: **Nicholas W Oakley**, Portland, OR
(US); **Kannan G Raja**, Beaverton, OR
(US)

(73) Assignee: **Intel Corporation**, Santa Clara, CA
(US)

(**) Term: **15 Years**

(21) Appl. No.: **29/569,412**

(22) Filed: **Jun. 27, 2016**

(51) **LOC (10) Cl.** **14-02**

(52) **U.S. Cl.**
USPC **D14/315**

(58) **Field of Classification Search**
USPC D14/315-327; D18/1, 2, 7, 11;
235/145 A, 145 R; 341/22, 23; 345/104,
345/156, 168, 169, 173; 361/679.08,
361/679.09, 679.11, 679.26, 679.27
CPC G06F 1/16; G06F 1/1616; G06F 1/1626;
G06F 1/1632; G06F 1/1613; G06F
1/1601; G06F 1/1618; G06F 1/162; G06F
1/166; G06F 1/1654; G06F 1/1681; G06F
1/1637; G06F 1/1688; G06F 1/1656;
H01R 35/02; H03M 11/00; G09B 13/04;
H03K 17/94; G09G 5/00; F16M 11/10;
H05K 5/00; H04M 1/0237
See application file for complete search history.

(56) **References Cited**

U.S. PATENT DOCUMENTS

6,771,494 B2 * 8/2004 Shimano G06F 1/1616
345/173
D705,773 S * 5/2014 Tian D14/316

D720,741 S * 1/2015 Leonard D14/315
D758,359 S * 6/2016 Reed D14/315
2004/0074050 A1 * 4/2004 Birtley E05D 11/087
16/340
2004/0246666 A1 * 12/2004 Maskatia G06F 1/1616
361/679.57

* cited by examiner

Primary Examiner — Freda S Nunn

(74) *Attorney, Agent, or Firm* — Schwegman Lundberg &
Woessner, P.A.

(57) **CLAIM**

The ornamental design for a notebook computer, as shown
and described.

DESCRIPTION

FIG. 1 is a front perspective view of the notebook computer
in a partly open orientation;
FIG. 2 is a rear perspective view thereof;
FIG. 3 is top plan view thereof;
FIG. 4 is a bottom plan view thereof;
FIG. 5 is a front view thereof;
FIG. 6 is a back view thereof;
FIG. 7 is a right side view thereof;
FIG. 8 is a left side view thereof;
FIG. 9 is a perspective view thereof in a closed orientation;
FIG. 10 is another perspective view thereof;
FIG. 11 is a top plan view thereof;
FIG. 12 is a bottom plan view thereof;
FIG. 13 is a front view thereof;
FIG. 14 is a back view thereof;
FIG. 15 is a right side view thereof; and,
FIG. 16 is a left side view thereof.

The broken lines shown in the drawings represent environ-
ment only and form no part of the claimed design.

1 Claim, 13 Drawing Sheets

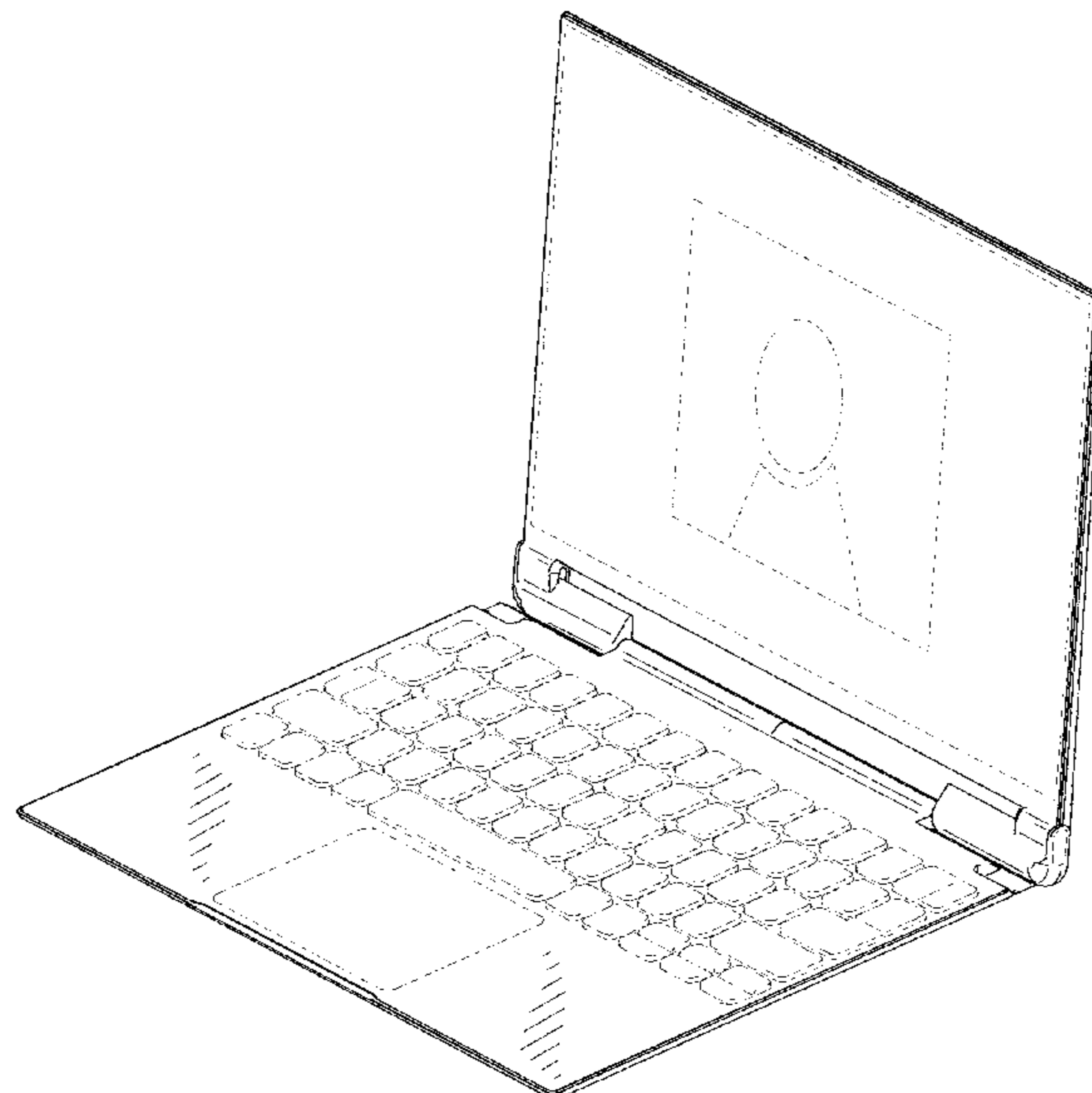

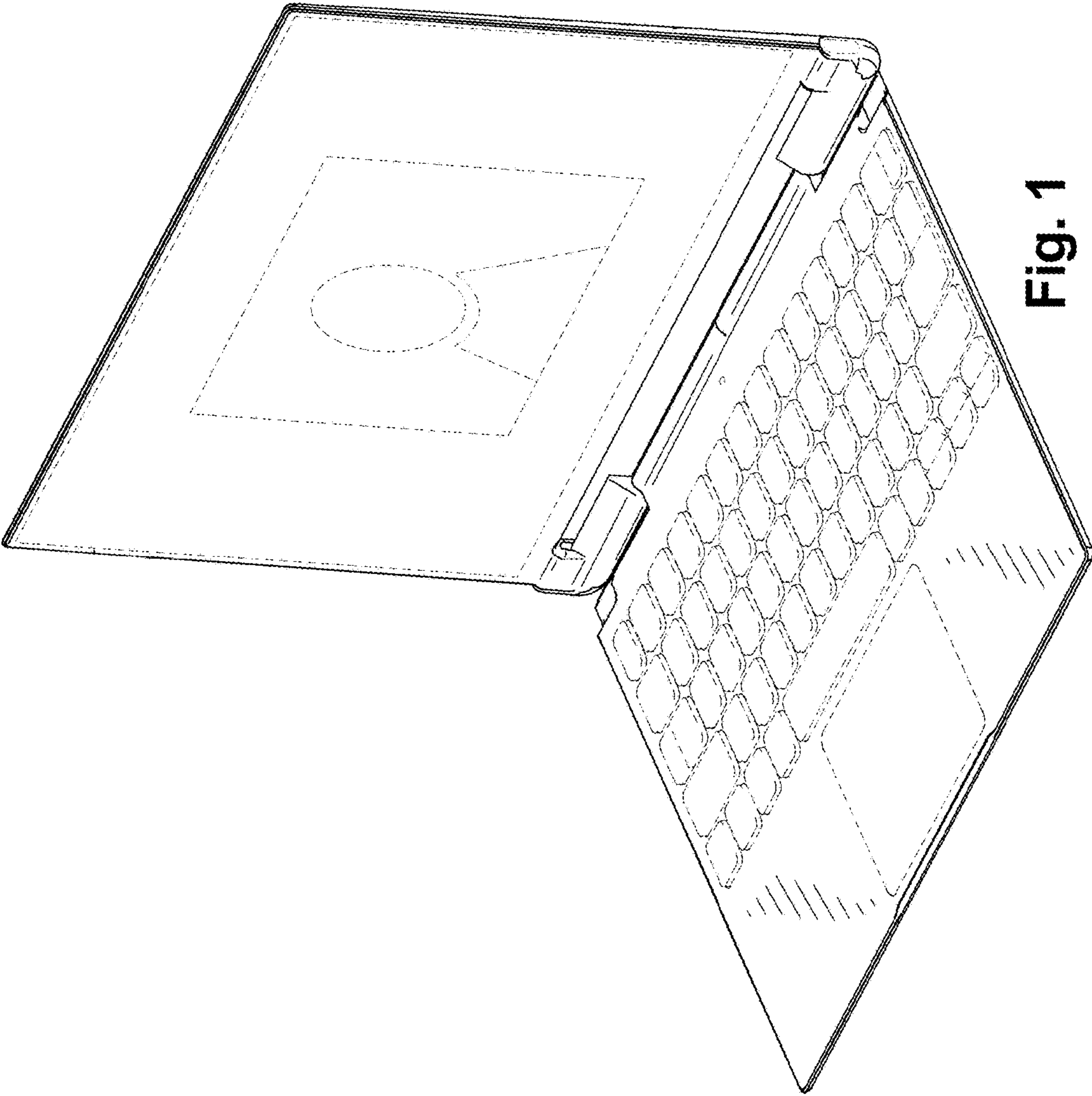

Fig. 1

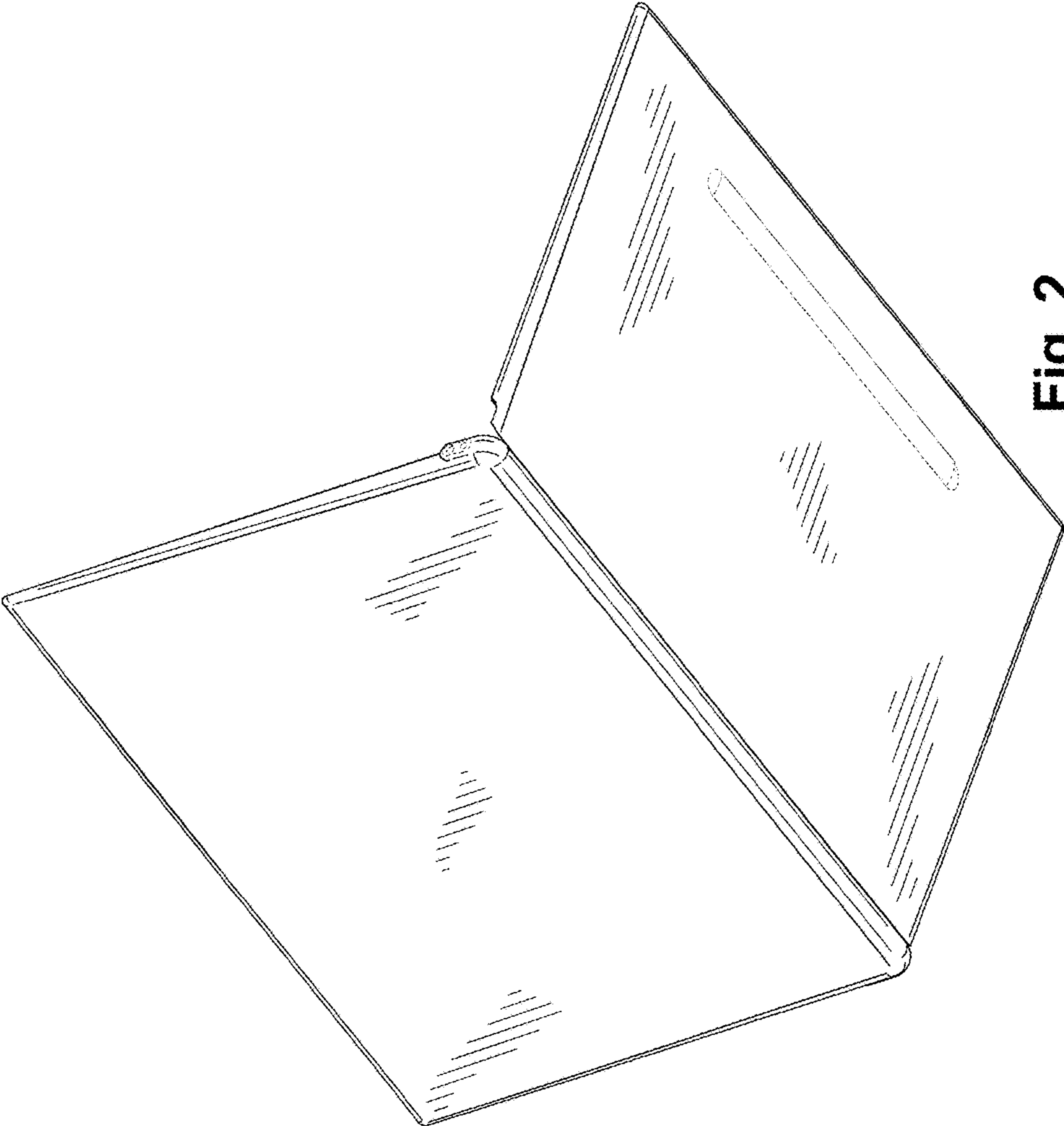

Fig. 2

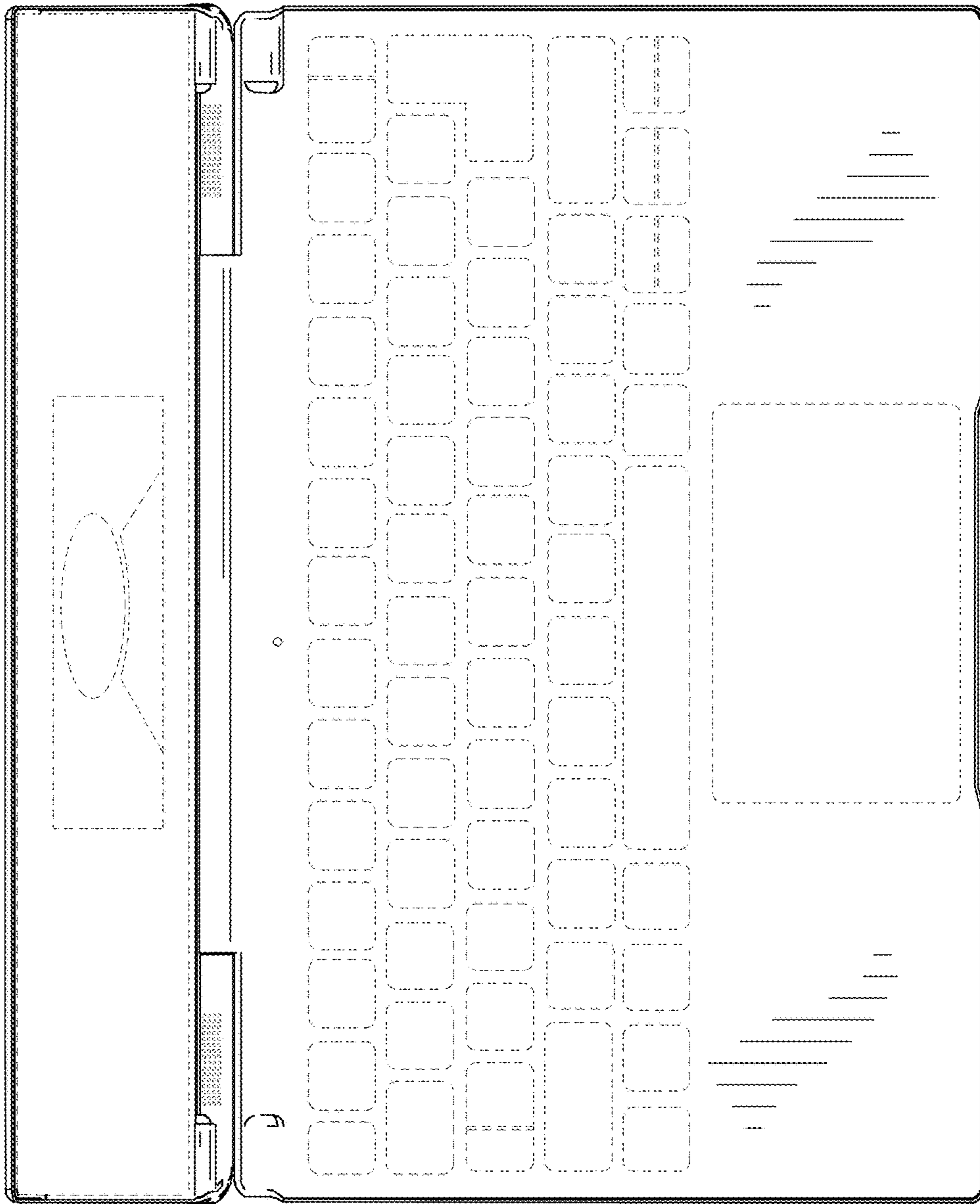

Fig. 3

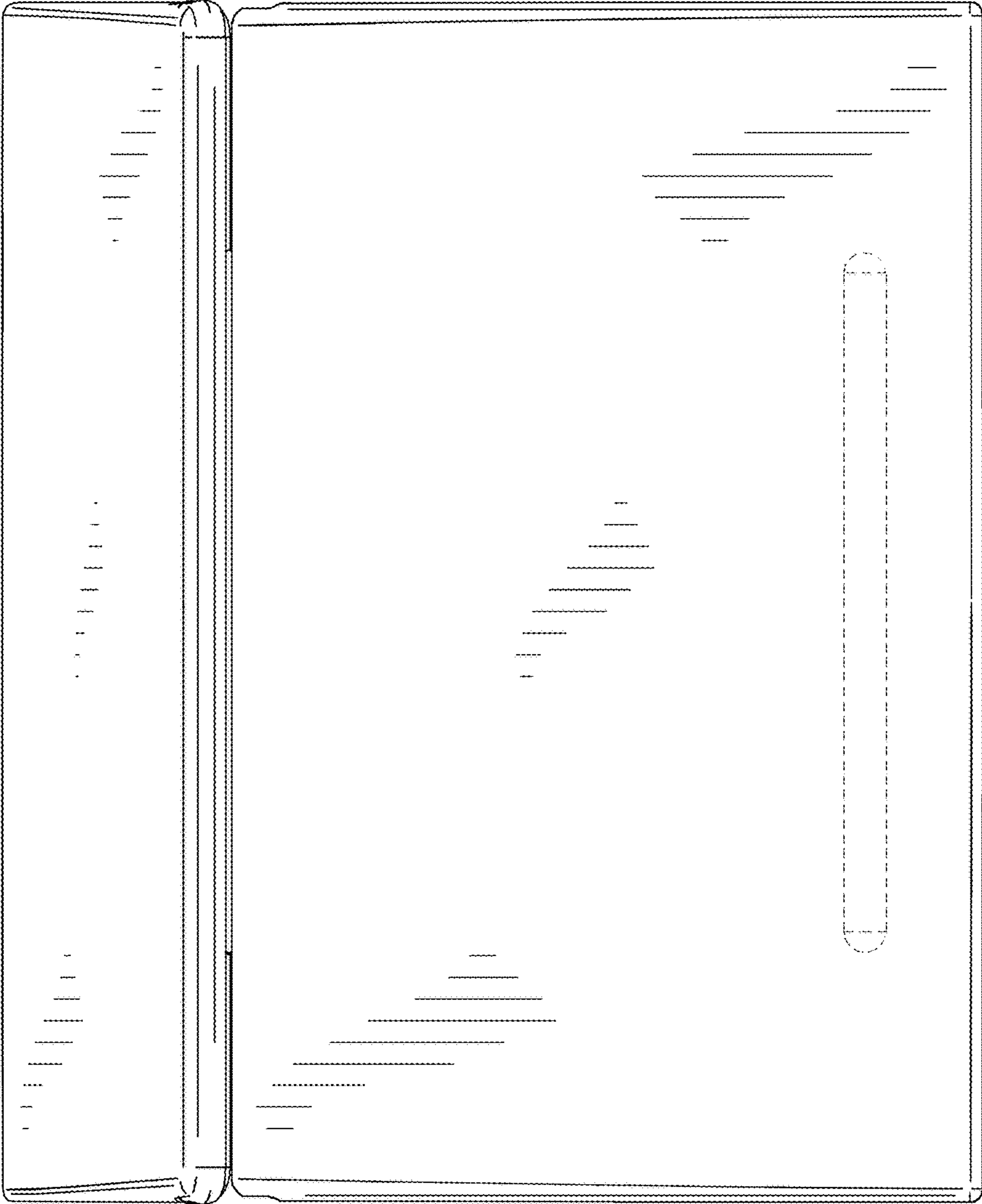

Fig. 4

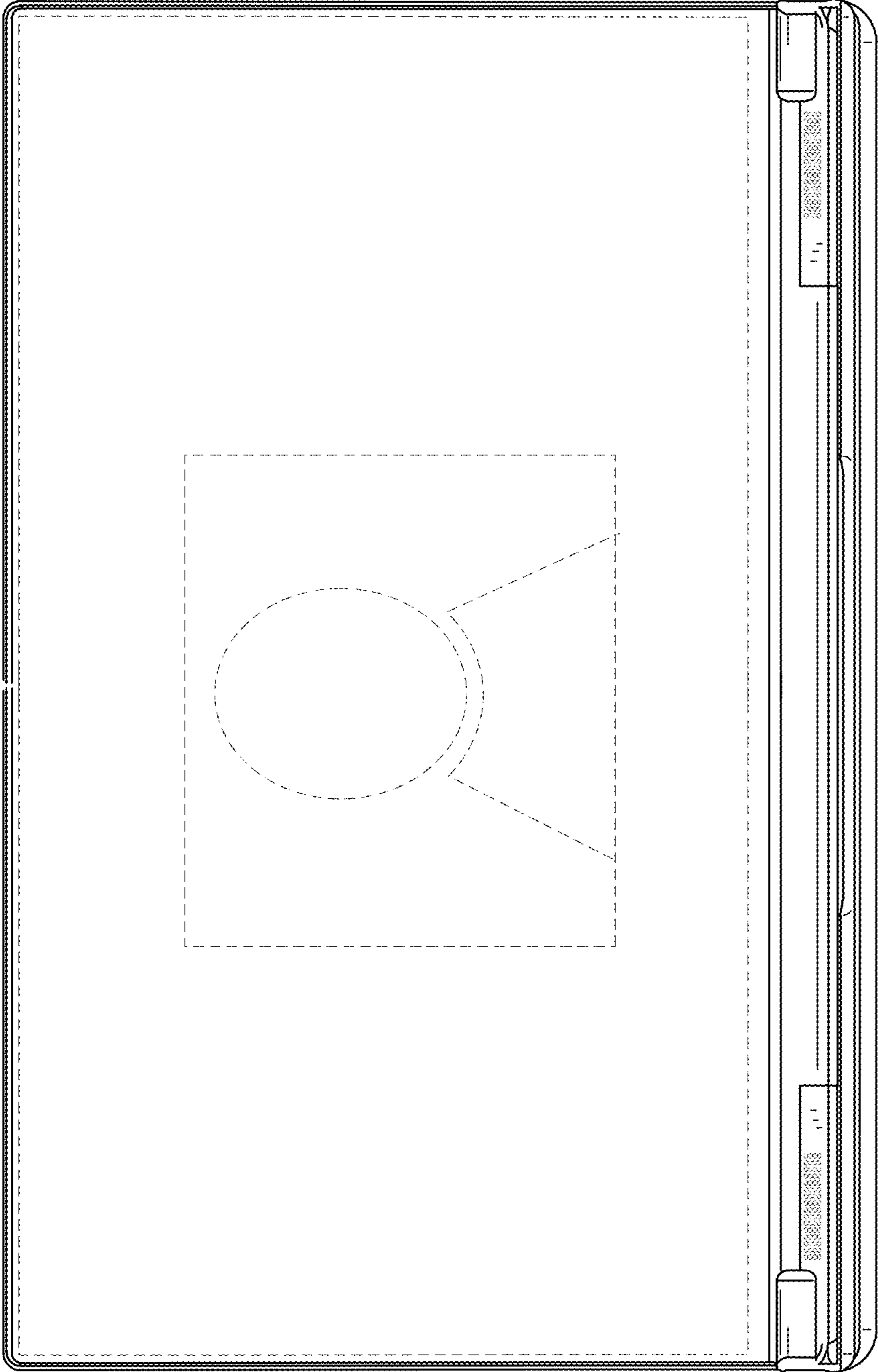

Fig. 5

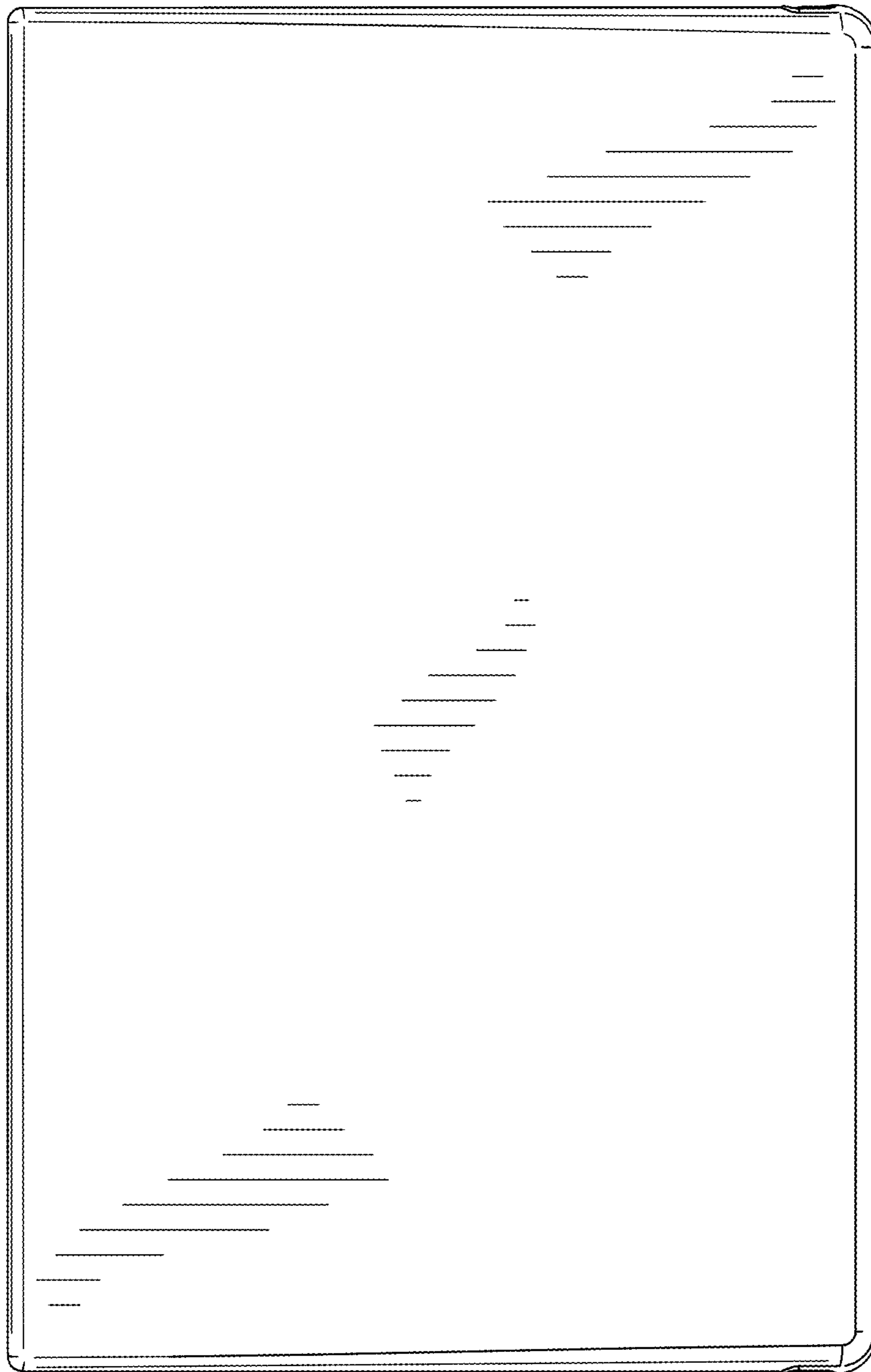

Fig. 6

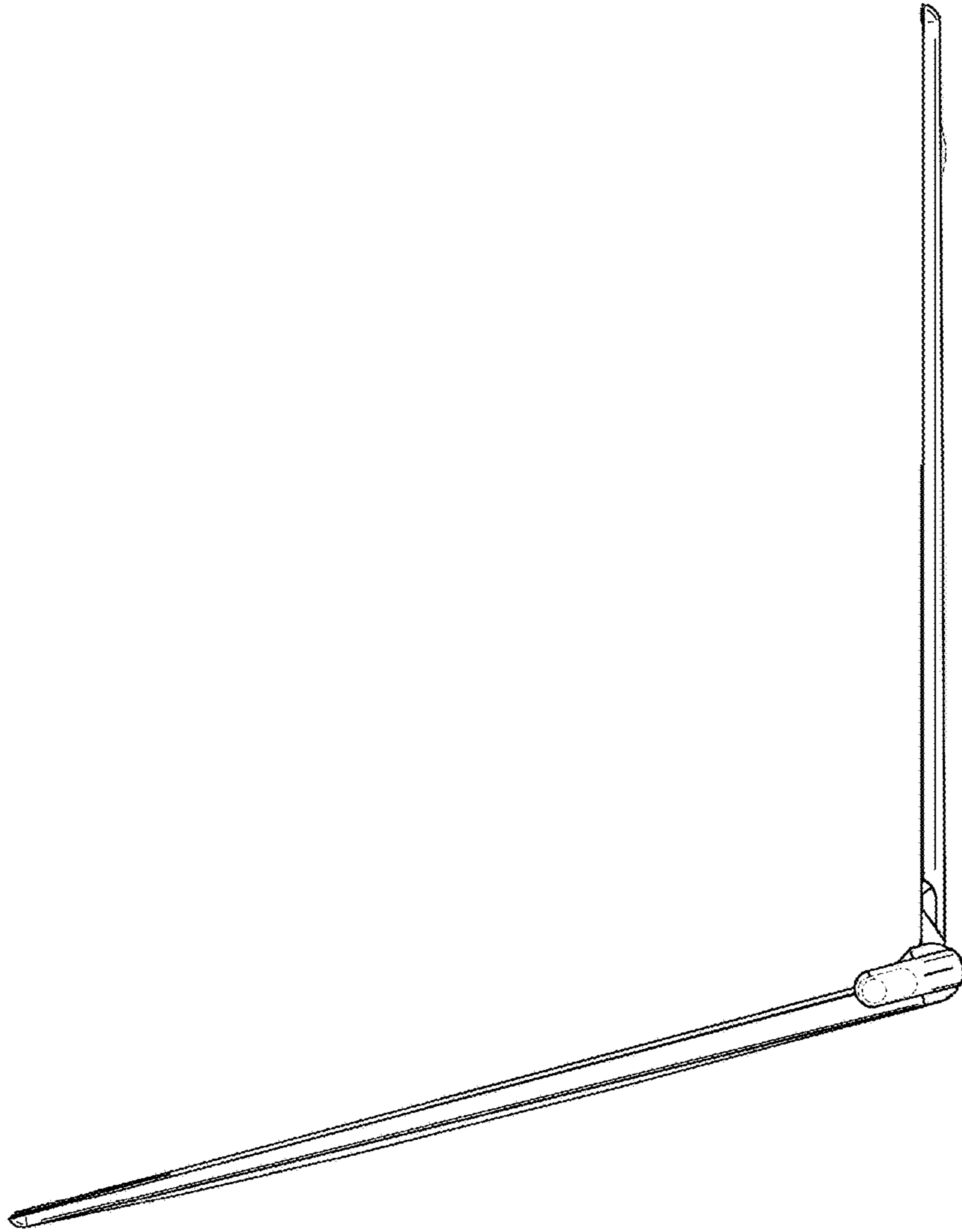

Fig. 7

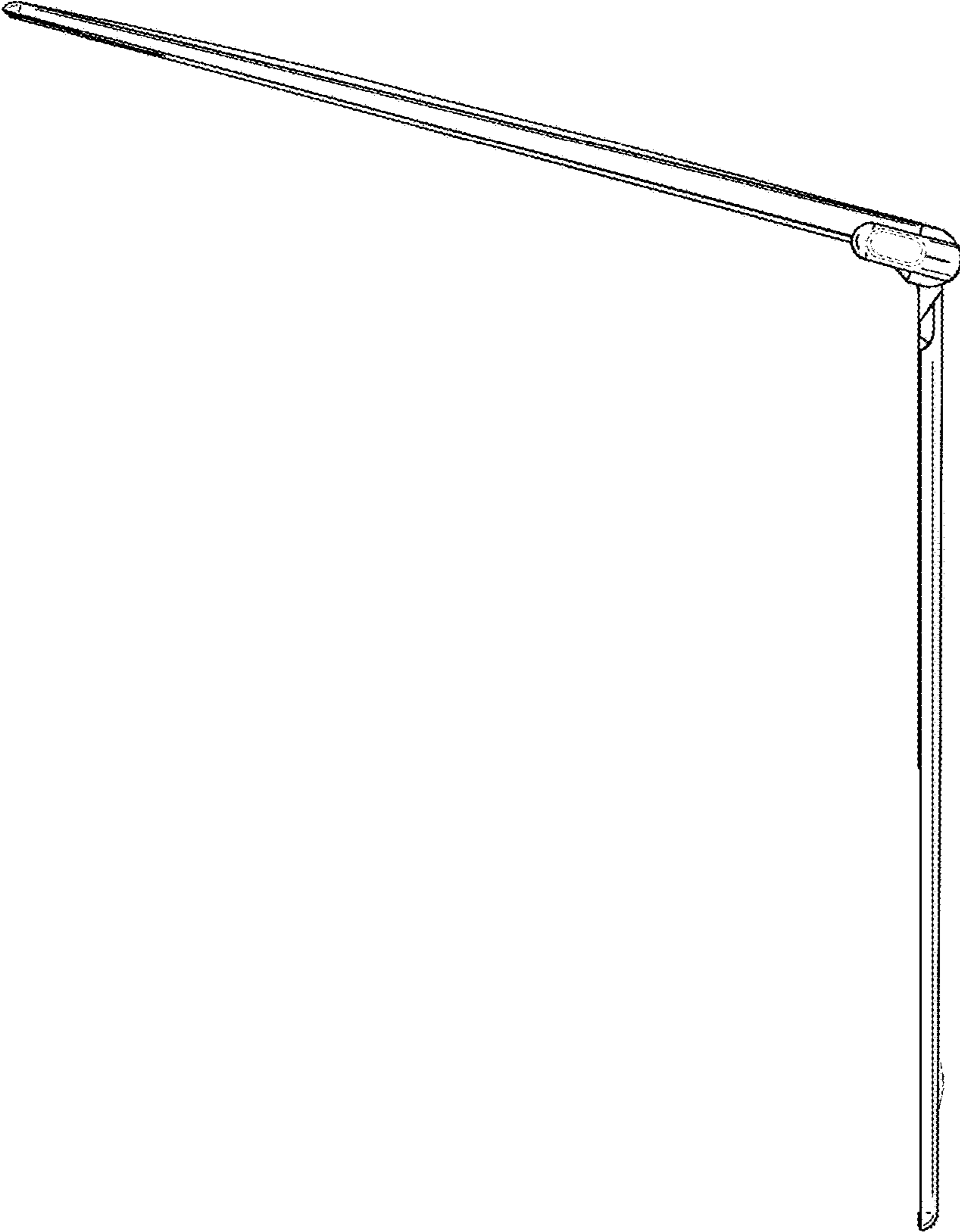

Fig. 8

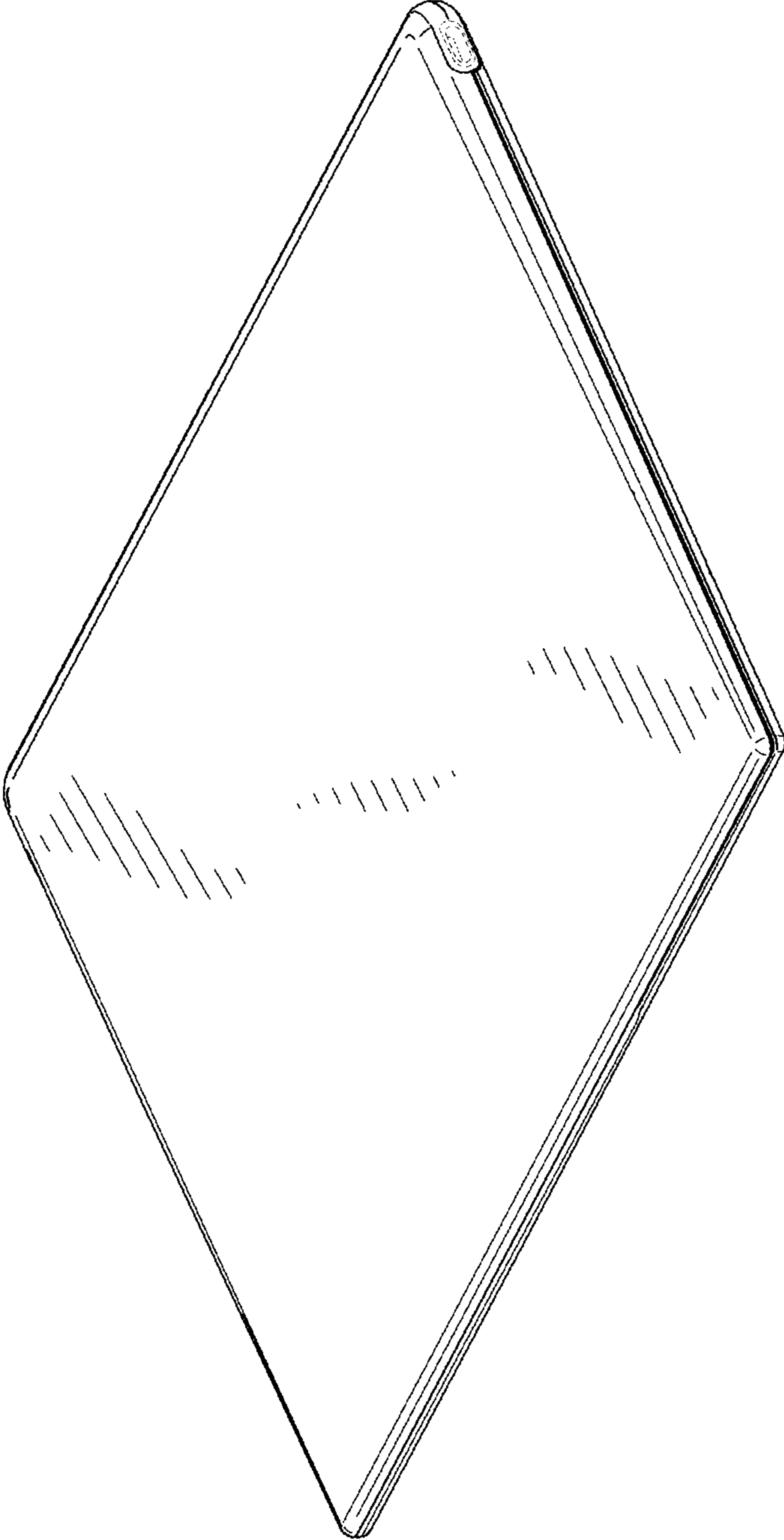

Fig. 9

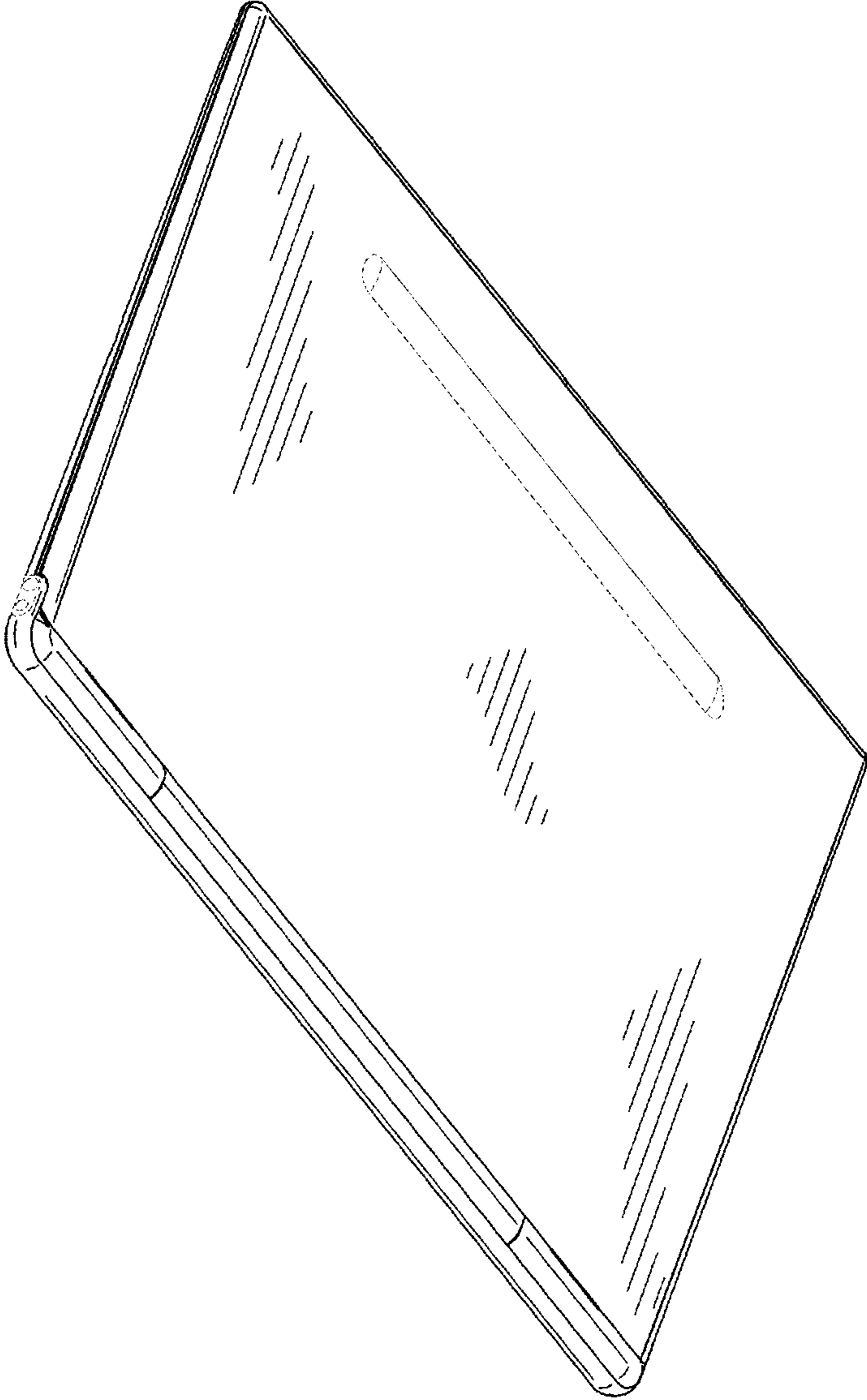

Fig. 10

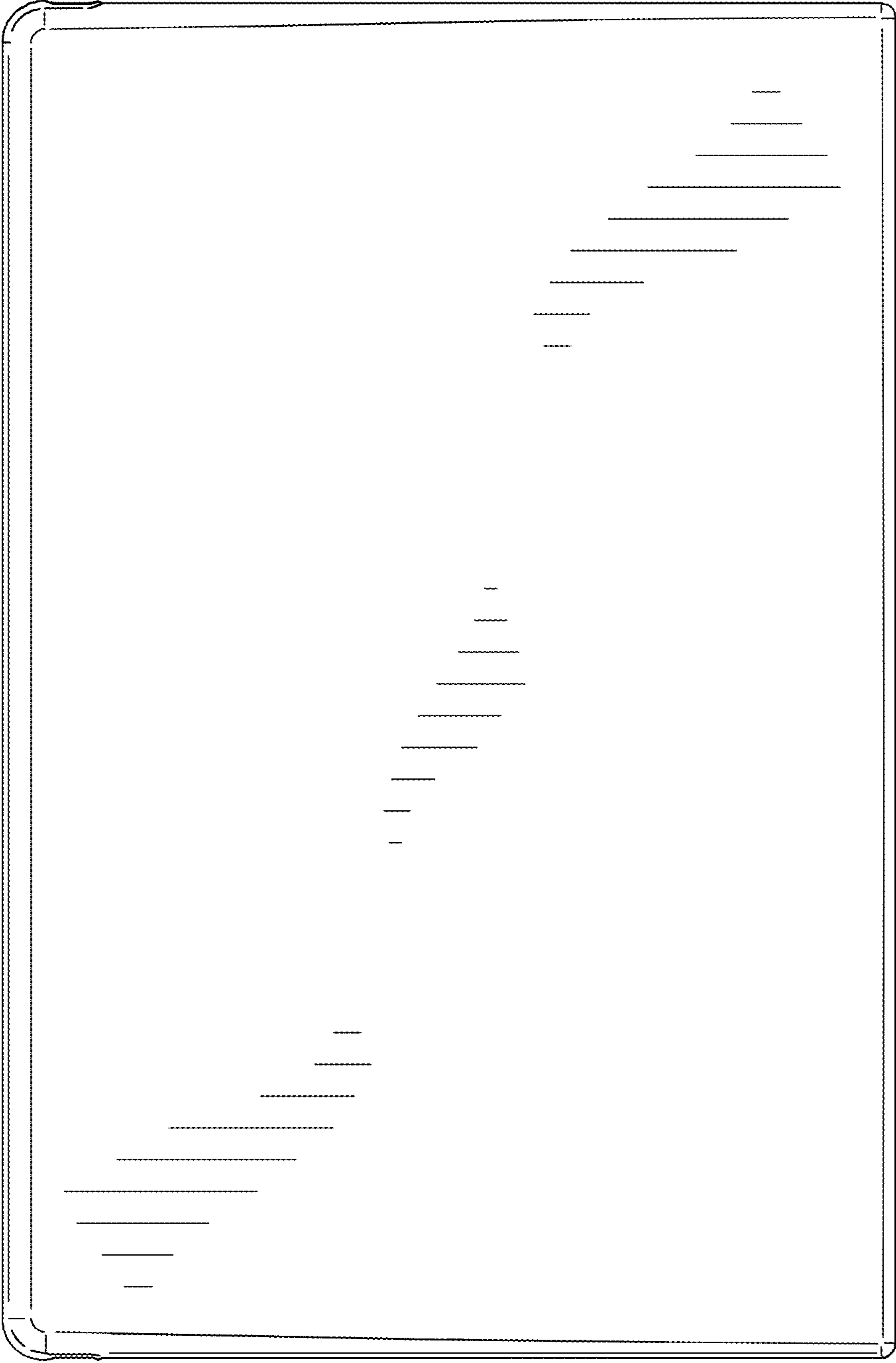

Fig. 11

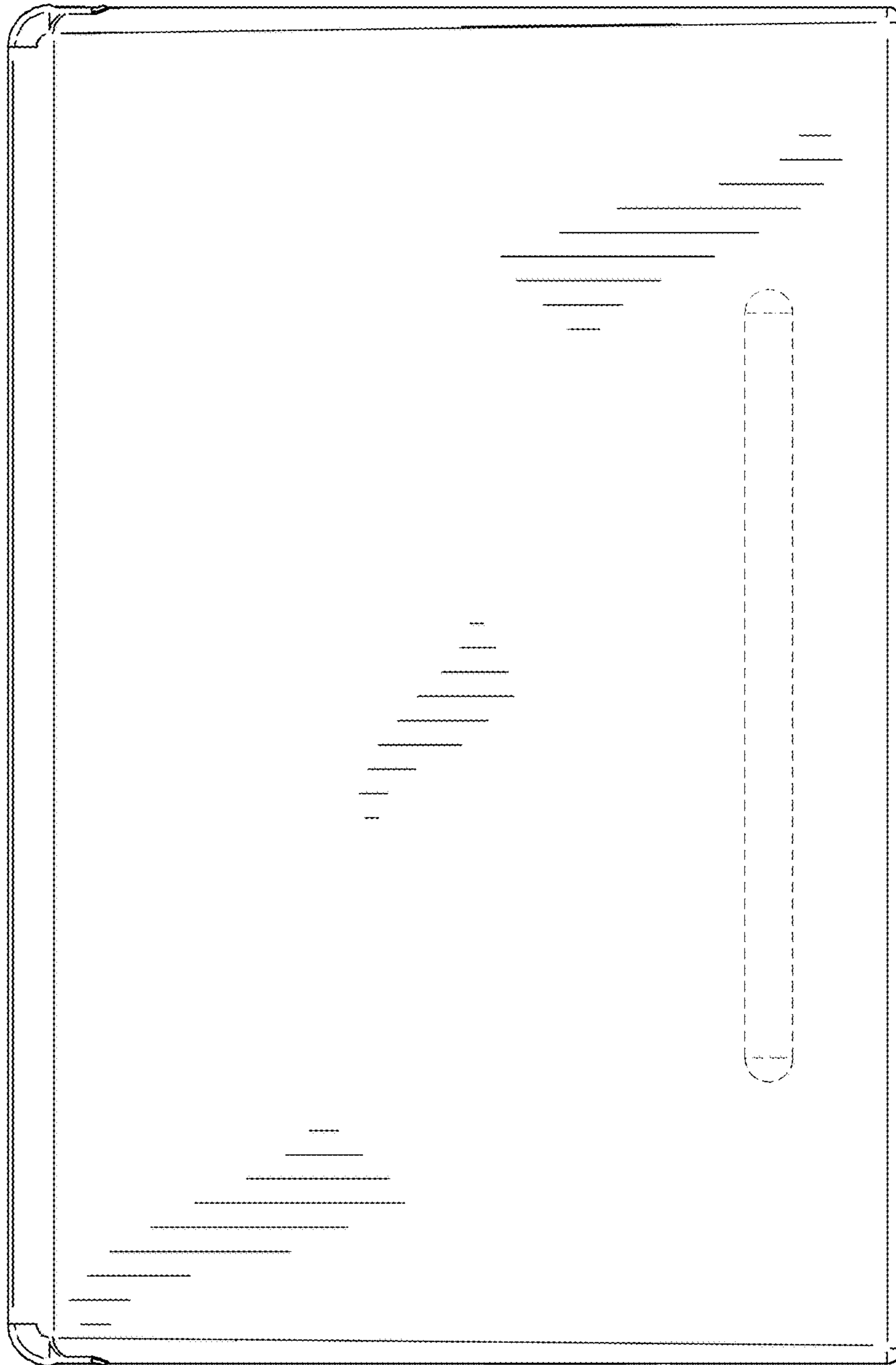

Fig. 12



Fig. 13

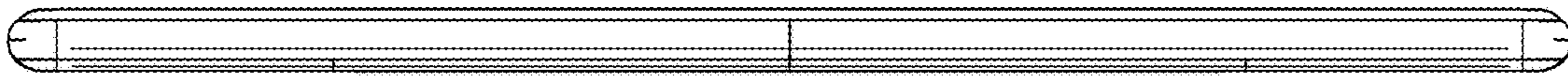

Fig. 14

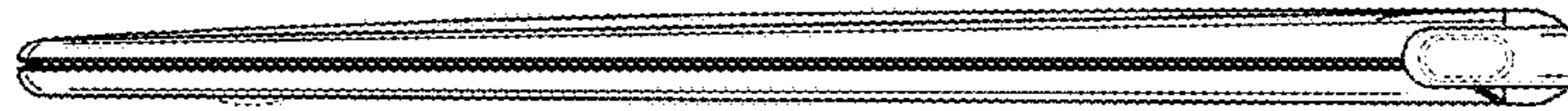

Fig. 15

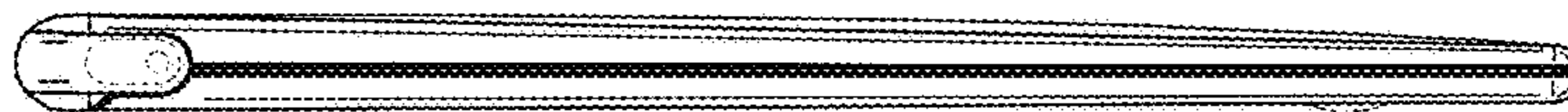

Fig. 16