



US00D802506S

(12) **United States Design Patent** (10) **Patent No.:** **US D802,506 S**  
**Bargen et al.** (45) **Date of Patent:** **\*\* Nov. 14, 2017**

(54) **COMBINED LICENSE PLATE AND EXTENSION CORD HOLDER**

D471,497 S \* 3/2003 Baker ..... D12/193  
D502,434 S \* 3/2005 Leibman ..... D12/193  
D530,926 S \* 10/2006 Sellers ..... D6/300

(71) Applicants: **David Bargen, Winkler (CA); Pawel Bargen, Winkler (CA)**

(Continued)

(72) Inventors: **David Bargen, Winkler (CA); Pawel Bargen, Winkler (CA)**

*Primary Examiner* — George D Kirschbaum

*Assistant Examiner* — Natasha Vujcic

(74) *Attorney, Agent, or Firm* — Kyle R. Satterthwaite; Ryan W. Dupuis; Ade + Company Inc.

(\*\*) Term: **15 Years**

(21) Appl. No.: **29/564,140**

(22) Filed: **May 11, 2016**

(57) **CLAIM**

The ornamental design for a combined license plate and extension cord holder, as shown and described.

(30) **Foreign Application Priority Data**

**DESCRIPTION**

Nov. 17, 2015 (CA) ..... 165309

(51) **LOC (10) Cl.** ..... **12-16**

(52) **U.S. Cl.**  
USPC ..... **D12/193**

(58) **Field of Classification Search**  
USPC ..... D12/193; D6/300, 301, 302, 310, 311,  
D6/312, 313, 314; D20/13  
CPC ..... B60R 13/10; B60R 13/105; B60R 19/24;  
B60R 19/52  
See application file for complete search history.

FIG. 1 is a perspective view of a first embodiment of the combined license plate and extension cord holder;  
FIG. 2 is another perspective view of the first embodiment in use;  
FIG. 3 is a top view of the first embodiment.  
FIG. 4 is a right side view of the first embodiment, the left side view being a mirror image thereof;  
FIG. 5 is a front view of the first embodiment;  
FIG. 6 is a rear view of the first embodiment;  
FIG. 7 is a bottom plan view of the first embodiment;  
FIG. 8 is a perspective view of a second embodiment of the combined license plate and extension cord holder;  
FIG. 9 is another perspective view of the second embodiment in use;  
FIG. 10 is a top view of the second embodiment;  
FIG. 11 is a right side view of the second embodiment the left side view being a mirror image thereof;  
FIG. 12 is a front view of the second embodiment;  
FIG. 13 is a rear view of the second embodiment; and,  
FIG. 14 is a bottom plan view of the second embodiment.  
The broken lines in the drawings illustrates the environment and portions of the combined license plate and extension cord holder which forms no part of the claimed design.

(56) **References Cited**

**U.S. PATENT DOCUMENTS**

1,879,906 A \* 9/1932 Linstrom ..... B60R 13/105  
40/209  
D311,167 S \* 10/1990 Ching-Hwei ..... D12/193  
5,012,602 A \* 5/1991 Storey ..... B60R 13/105  
40/201  
5,056,698 A 10/1991 Kozakevich  
D370,450 S \* 6/1996 Doan ..... D12/193  
D396,439 S \* 7/1998 Turnquest ..... D12/193  
D396,679 S \* 8/1998 Findel, II ..... D12/193  
D397,073 S \* 8/1998 Kui ..... D12/191  
D406,806 S \* 3/1999 Wallace ..... D12/193  
D415,987 S \* 11/1999 Romero ..... D12/193

**1 Claim, 8 Drawing Sheets**

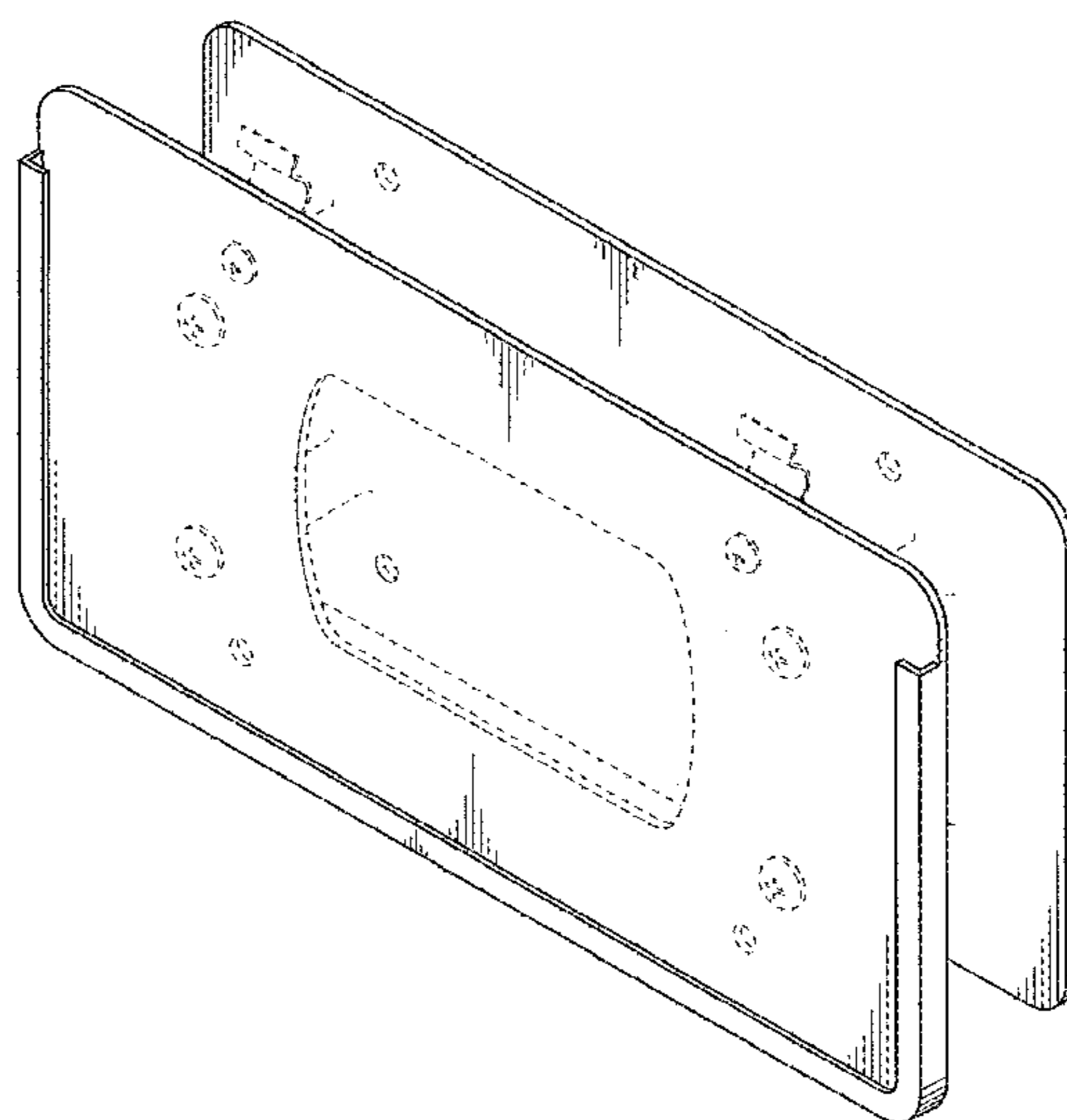

(56)

**References Cited**

U.S. PATENT DOCUMENTS

D575,985 S \* 9/2008 Delaney ..... D7/405  
D633,837 S \* 3/2011 Murray ..... D12/193  
D713,771 S \* 9/2014 Kuo ..... D12/193

\* cited by examiner

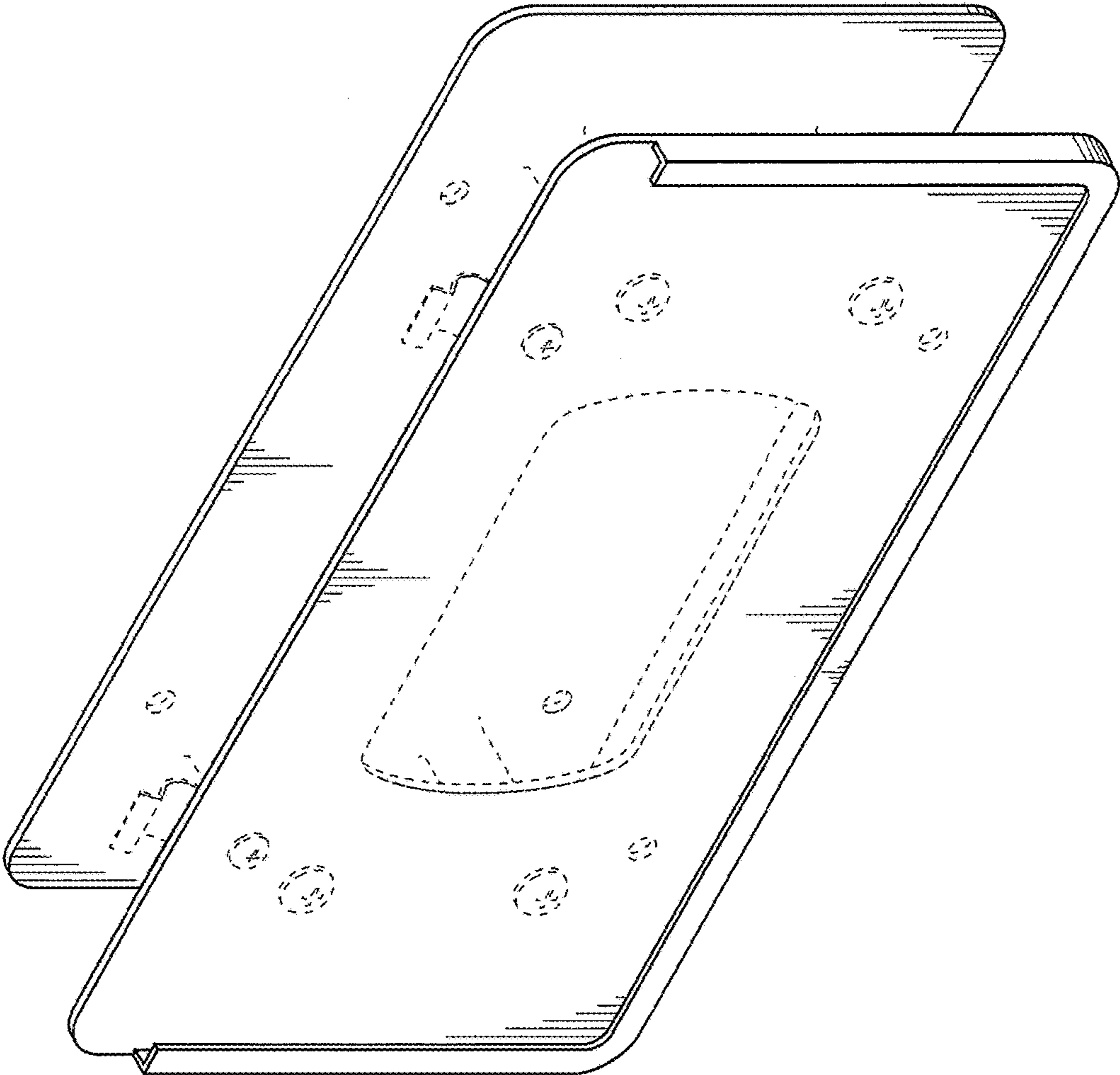

FIG. 1

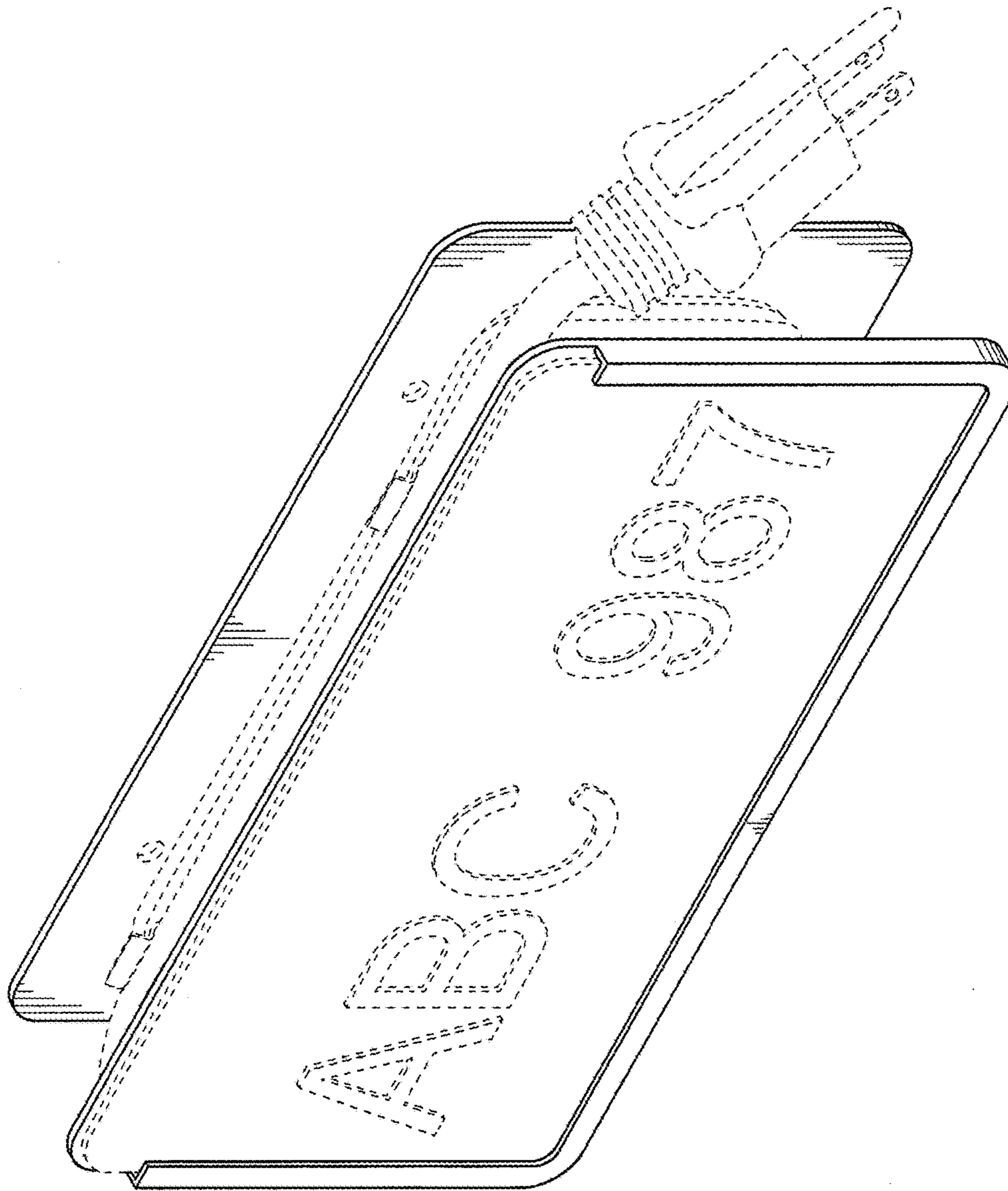

FIG. 2

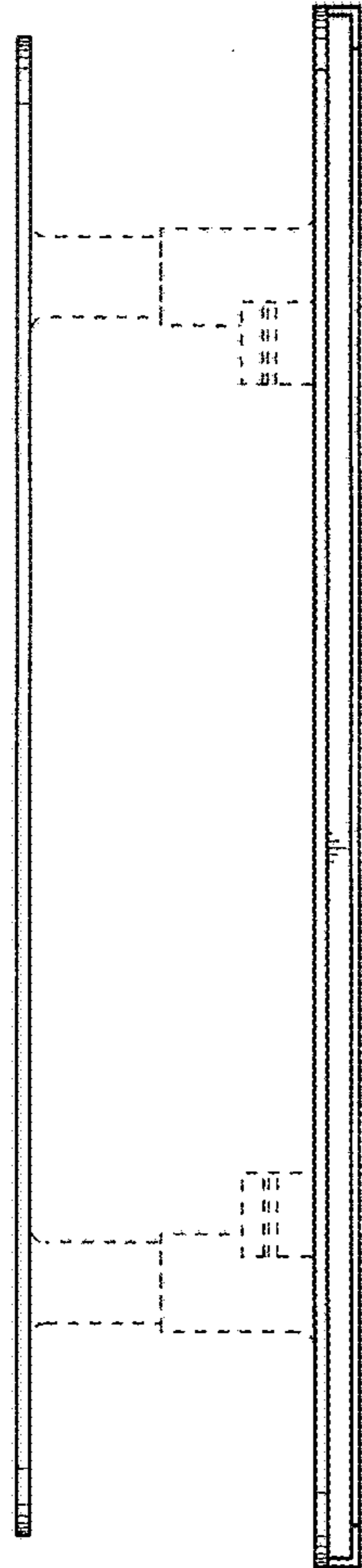

FIG. 3

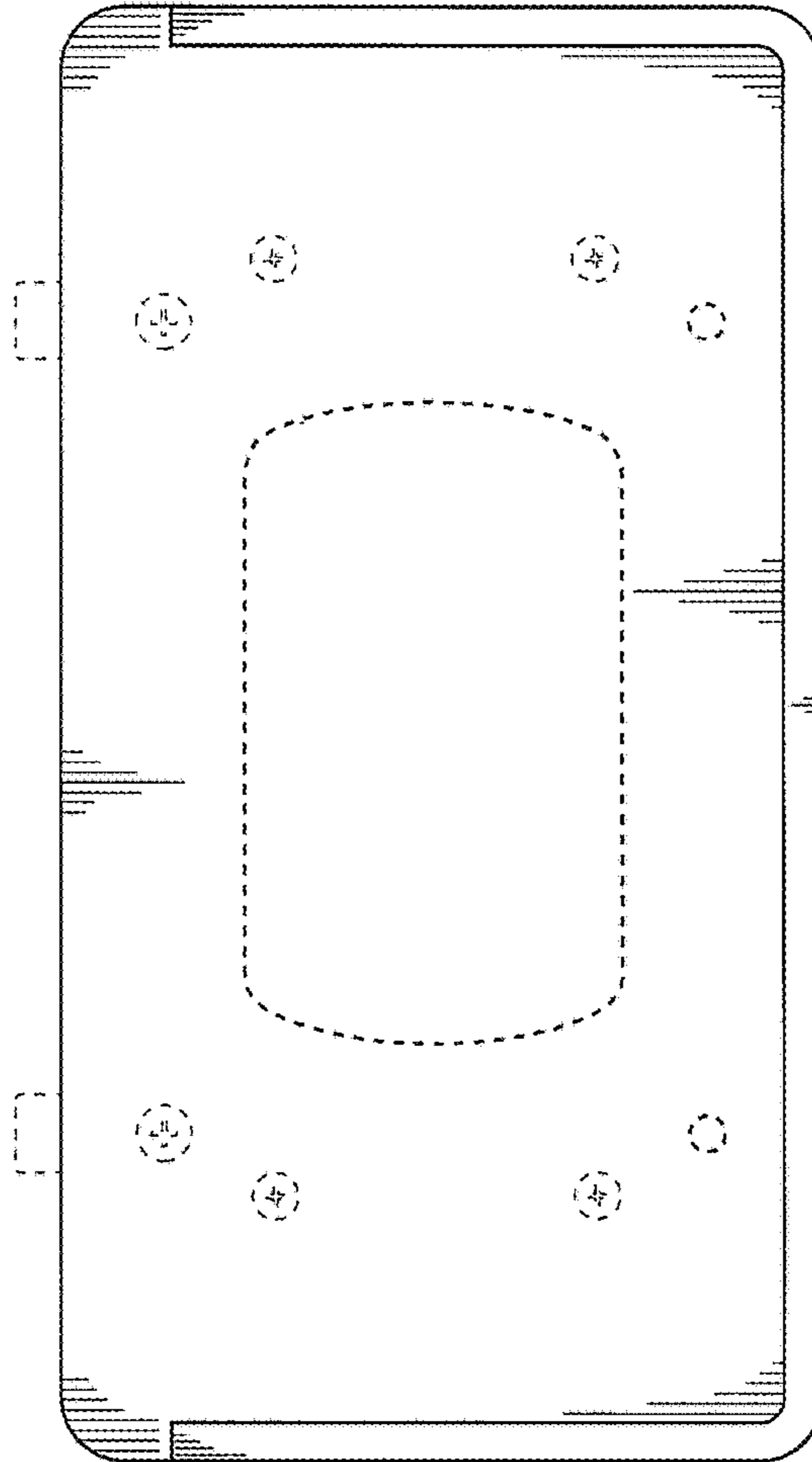

FIG. 5

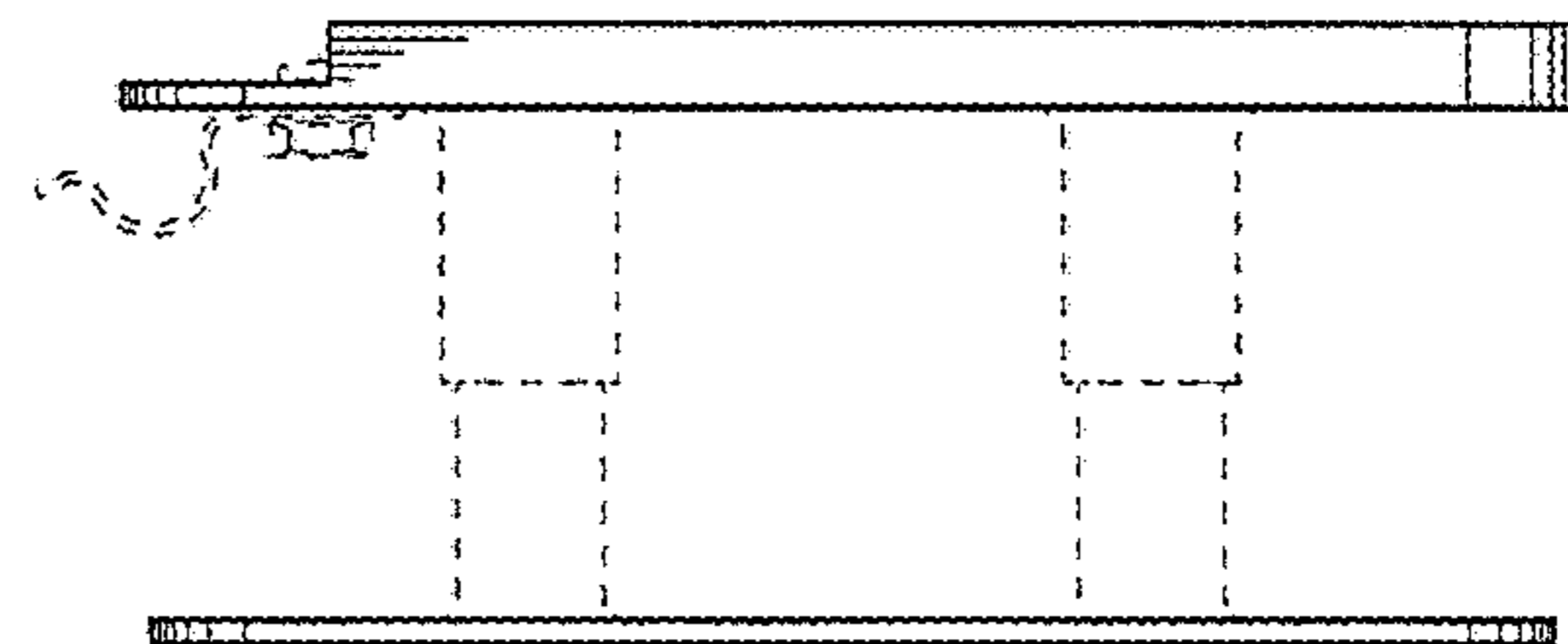

FIG. 4

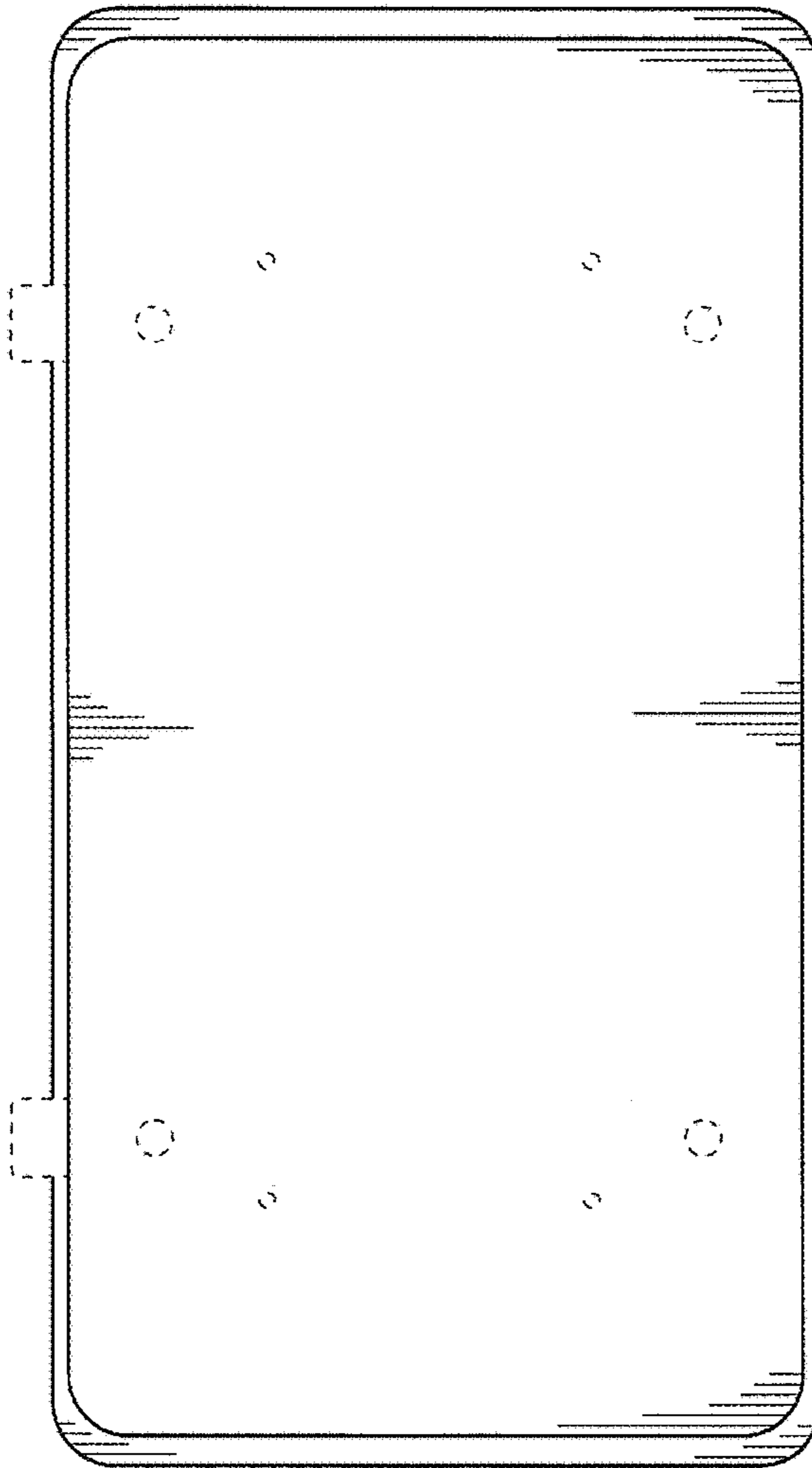

FIG. 6

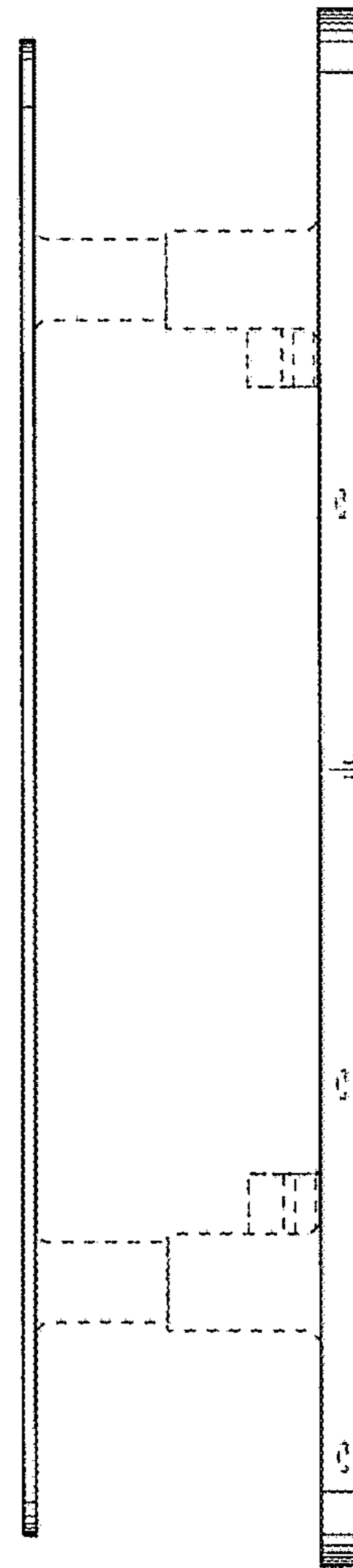

FIG. 7

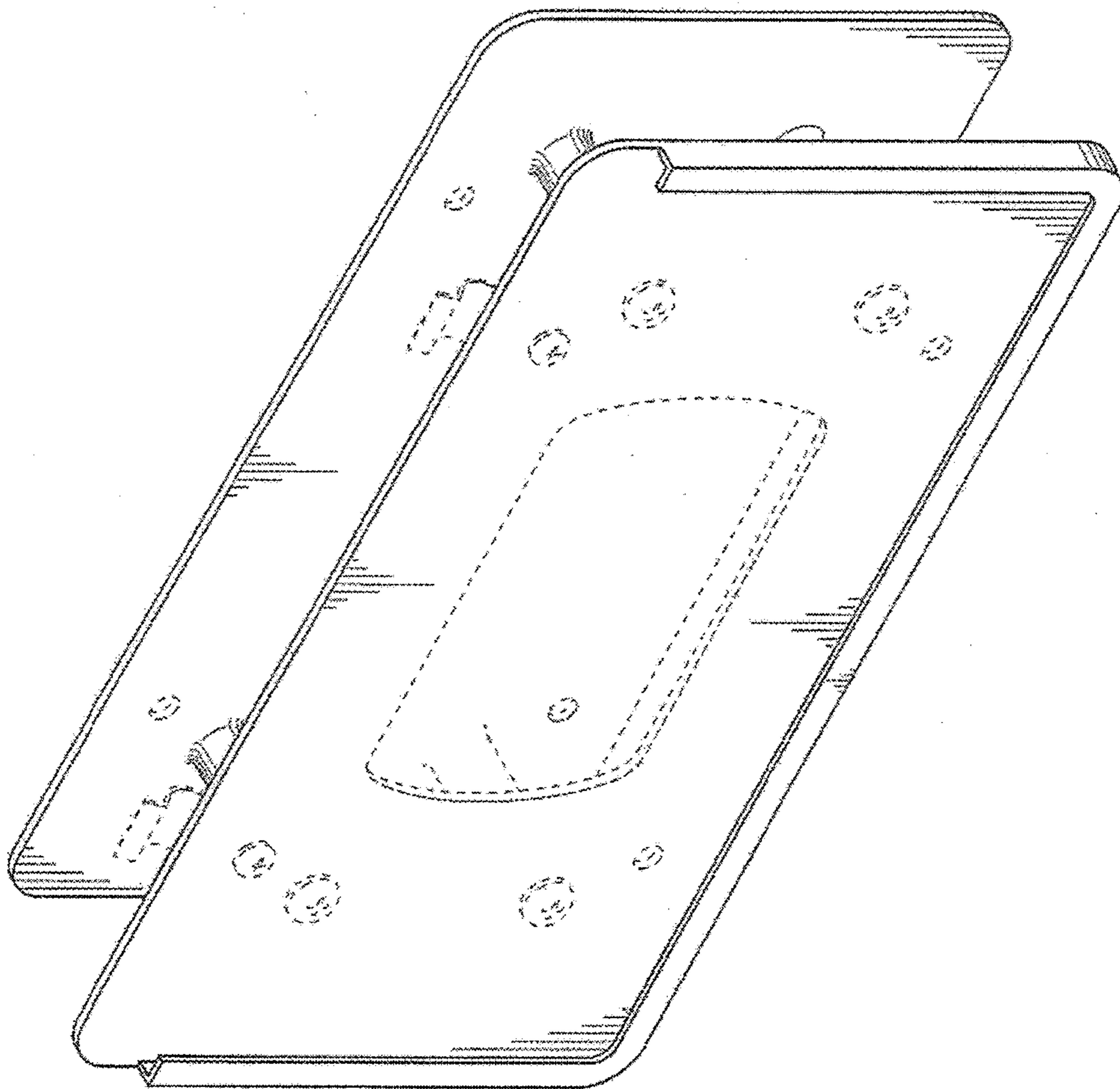

FIG. 8

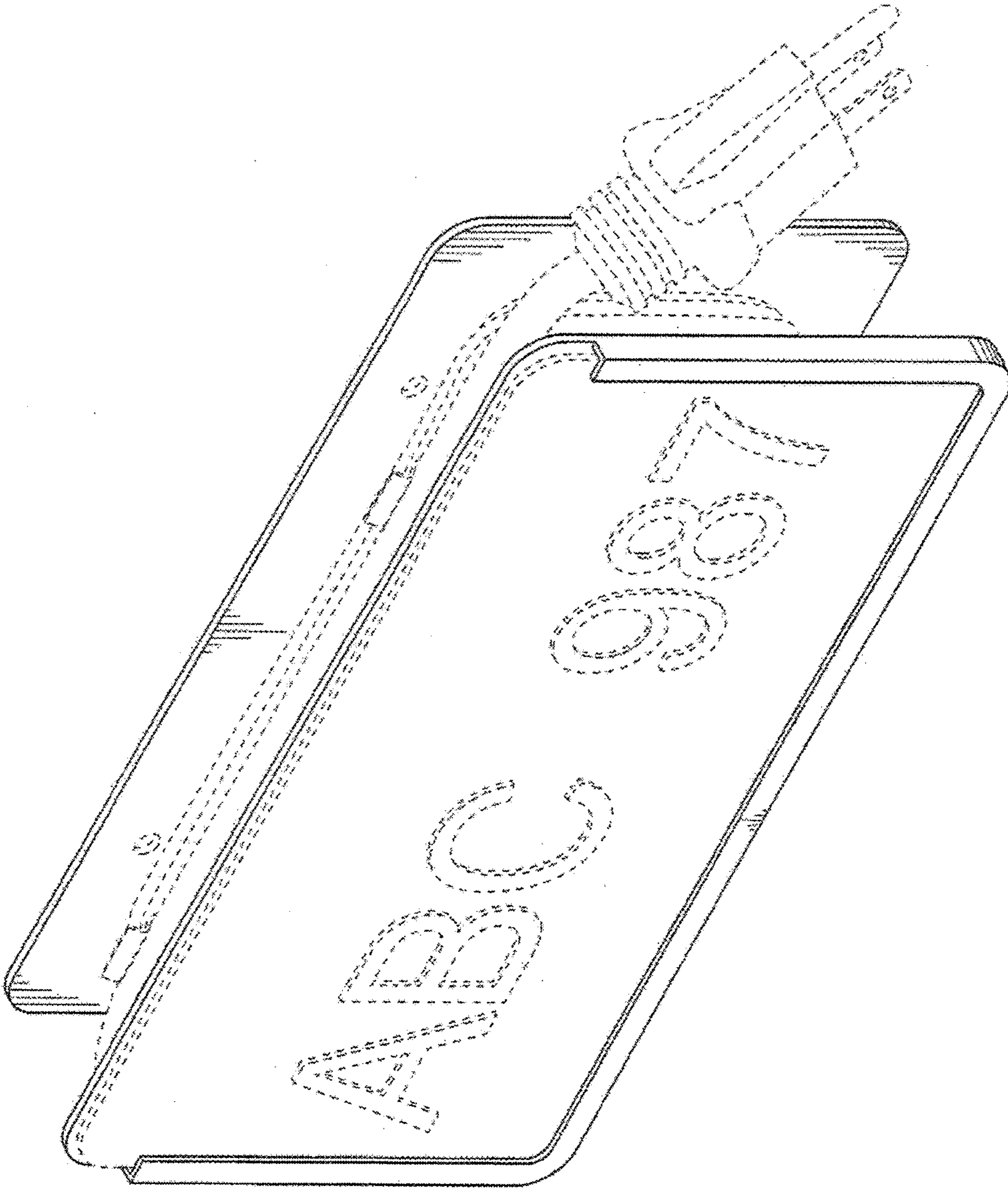

FIG. 9



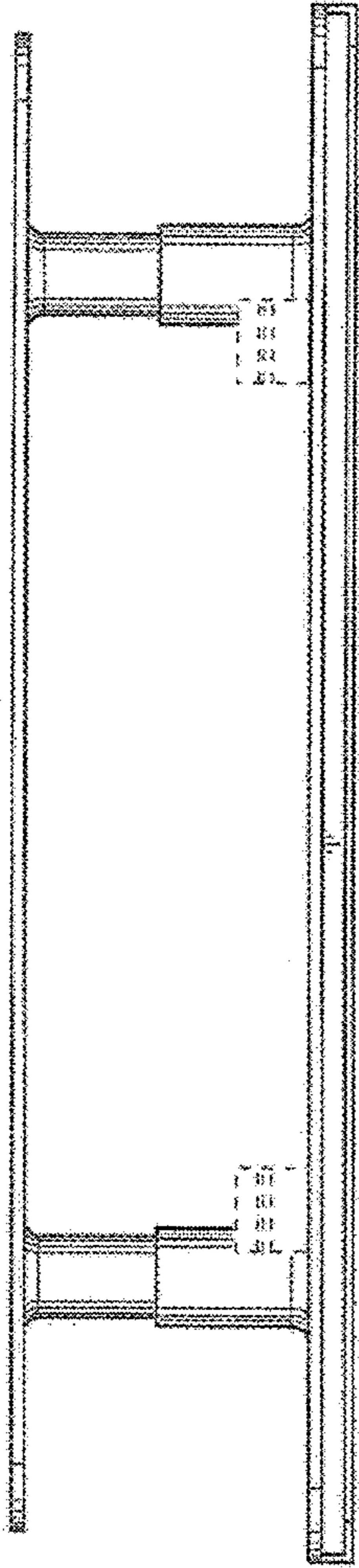

FIG. 10

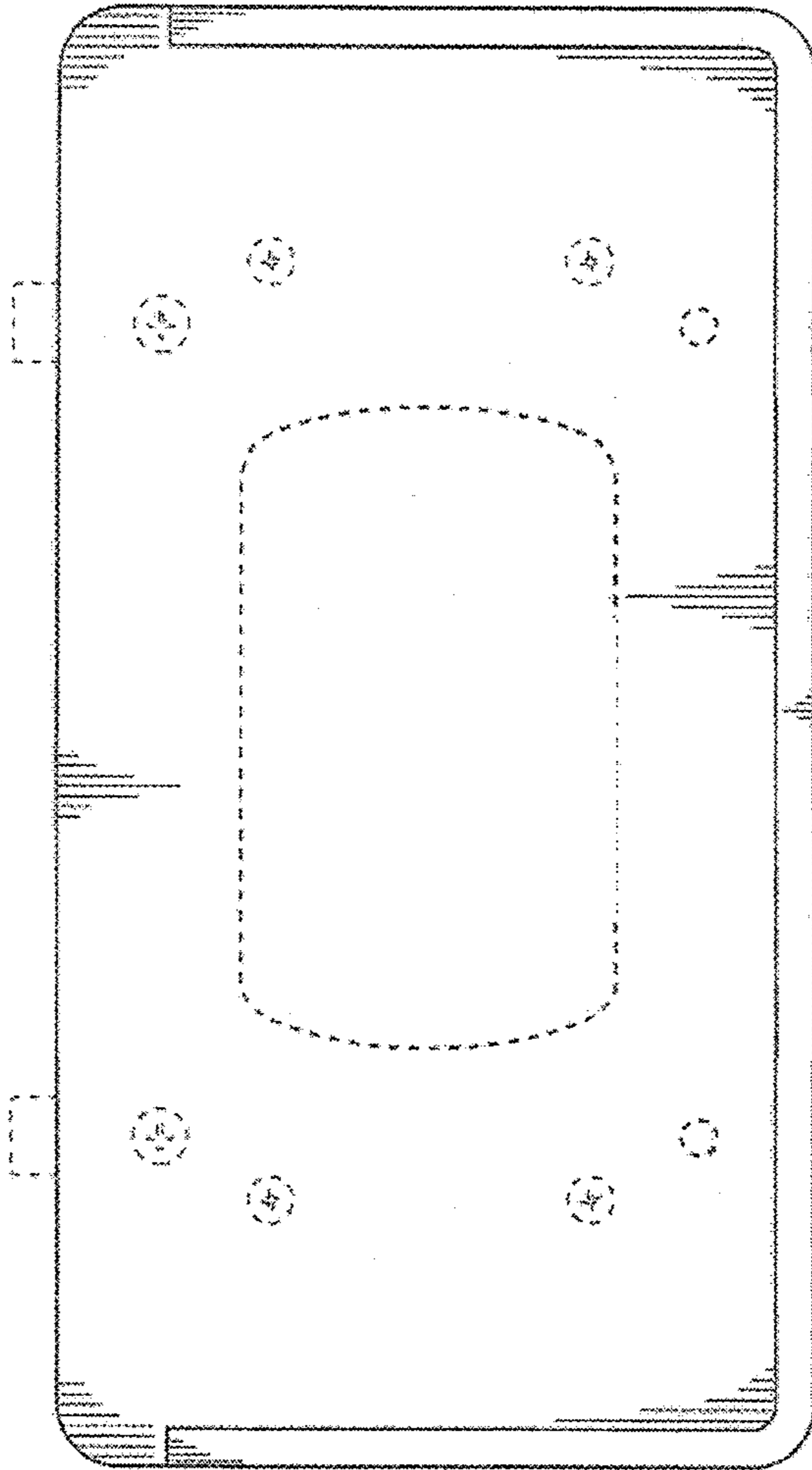

FIG. 12

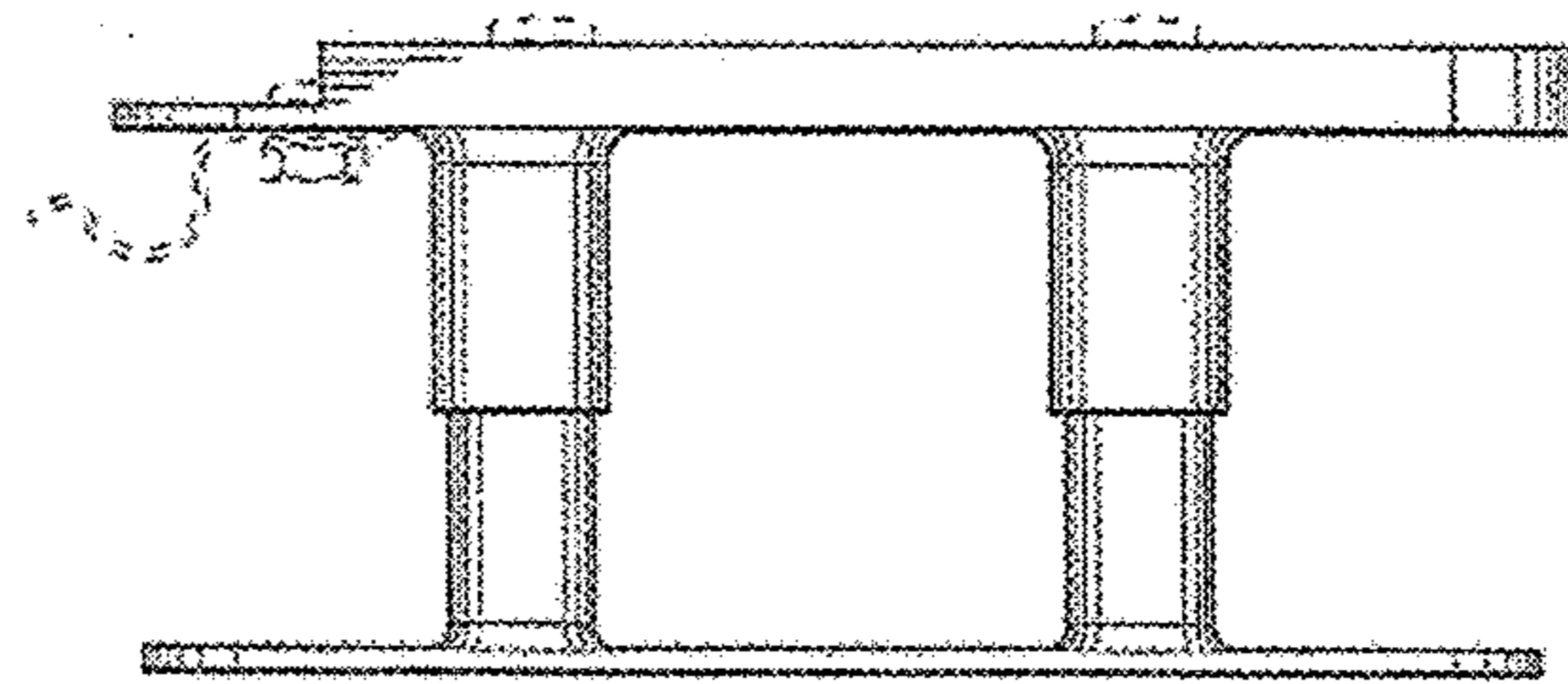

FIG. 11

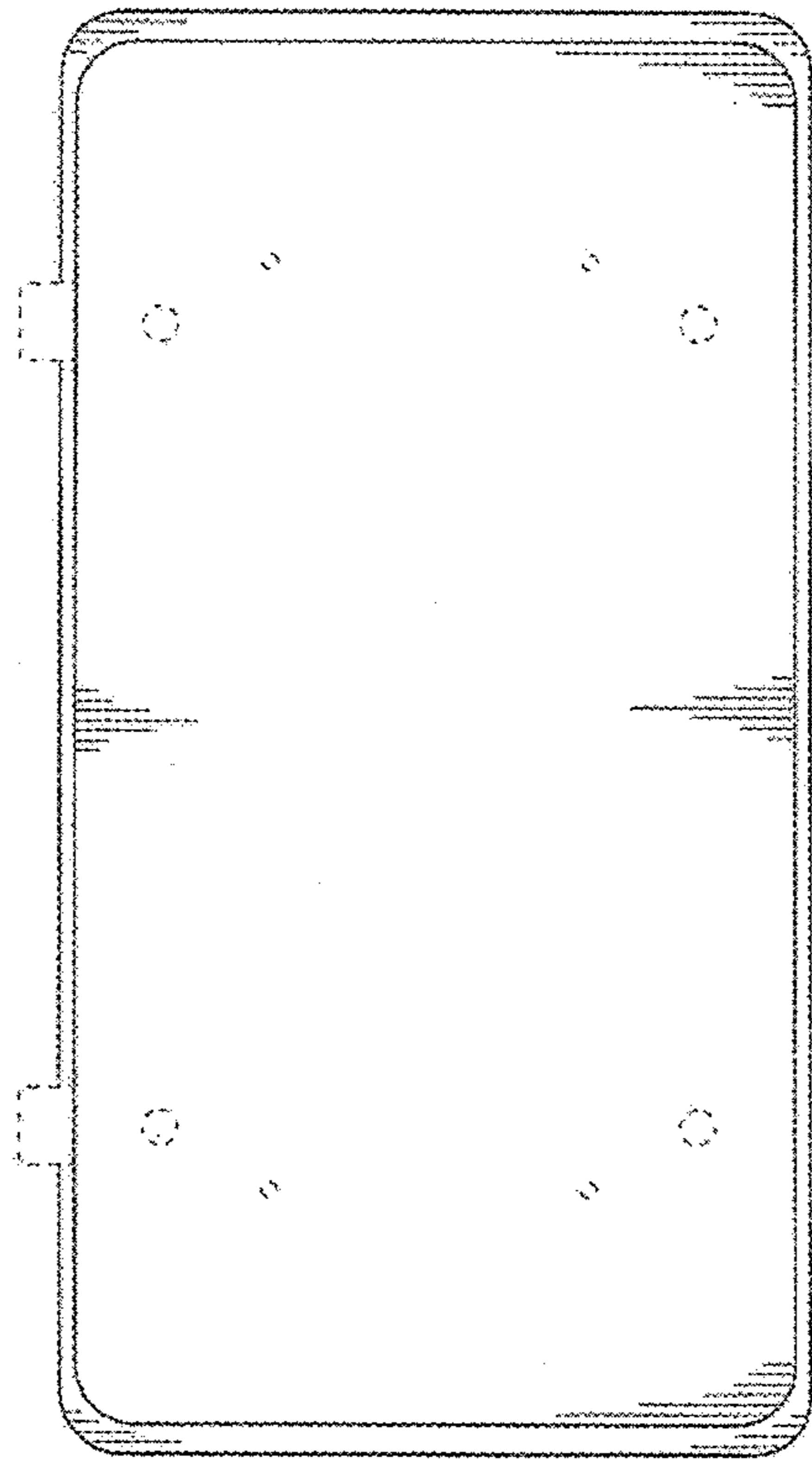

FIG. 13

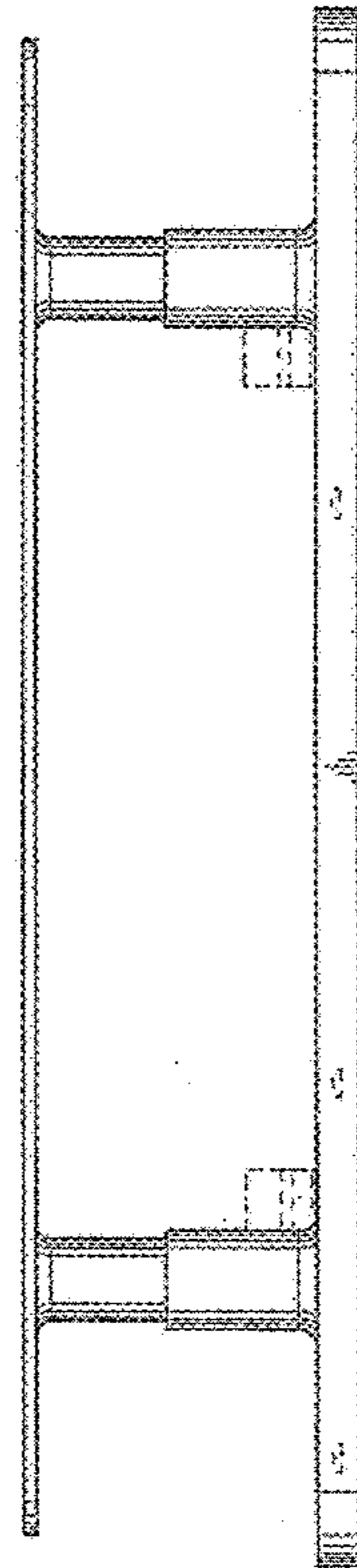

FIG. 14