



US00D802456S

(12) **United States Design Patent** (10) **Patent No.:** **US D802,456 S**  
**Huang** (45) **Date of Patent:** **\*\* Nov. 14, 2017**

- (54) **LEAKAGE CLAMP METER**
- (71) Applicant: **Fluke Corporation**, Everett, WA (US)
- (72) Inventor: **Wei Huang**, Shanghai (CN)
- (73) Assignee: **Fluke Corporation**, Everett, WA (US)
- (\*\*) Term: **15 Years**
- (21) Appl. No.: **29/553,931**
- (22) Filed: **Feb. 5, 2016**
- (30) **Foreign Application Priority Data**

Aug. 6, 2015 (CN) ..... 2015 3 0292978

- (51) **LOC (10) Cl.** ..... **10-04**
- (52) **U.S. Cl.**  
USPC ..... **D10/79**
- (58) **Field of Classification Search**  
USPC ..... D10/79  
CPC ..... G01R 1/04; G01R 1/0408; G01R 1/0416;  
G01R 1/0425; G01R 1/06; G01R 1/067;  
G01R 15/125; G01R 1/22; G01R 15/12;  
G01R 15/18; G01R 15/186; G01R 1/07;  
G01R 1/16772; G01R 1/16788  
See application file for complete search history.

(56) **References Cited**

**U.S. PATENT DOCUMENTS**

D416,820 S *	11/1999	Tanaka	.....	D10/79
D585,316 S *	1/2009	Chang	.....	D10/79
7,530,277 B2 *	5/2009	Miyasaka	.....	G01R 1/04 73/856
7,733,080 B1 *	6/2010	Liu	.....	G01R 1/22 324/126
7,750,621 B1 *	7/2010	Liu	.....	G01R 1/06788 324/126
D628,918 S *	12/2010	Chang	.....	D10/79
7,884,598 B2 *	2/2011	Wang	.....	G01R 1/22 324/117 H

(Continued)

*Primary Examiner* — Antoine D Davis  
(74) *Attorney, Agent, or Firm* — Seed IP Law Group LLP

(57) **CLAIM**

The ornamental design for a leakage clamp meter, as shown and described.

**DESCRIPTION**

The patent file contains at least one drawing executed in color. Copies of this patent with color drawings will be provided by the Office upon request and payment of the necessary fee.

FIG. 1 is a bottom, front right perspective view of a leakage clamp meter showing my new design including portions shown in color.

FIG. 2 is a front elevational view thereof.

FIG. 3 is a rear elevational view thereof.

FIG. 4 is a left side elevational view thereof.

FIG. 5 is a right side elevational view thereof.

FIG. 6 is a top plan view thereof.

FIG. 7 is a bottom plan view thereof.

FIG. 8 is a bottom, front right perspective view of another embodiment of a leakage clamp meter showing my new design including portions shown in color.

FIG. 9 is a front elevational view thereof.

FIG. 10 is a rear elevational view thereof.

FIG. 11 is a left side elevational view thereof.

FIG. 12 is a right side elevational view thereof.

FIG. 13 is a top plan view thereof; and,

FIG. 14 is a bottom plan view thereof.

The broken lines immediately adjacent the colored areas represent the bounds of the claimed design. All other broken lines within the bounds illustrate environment. The broken lines form no part of the claimed design, and no claim is made regarding color within the broken lines immediately adjacent the colored areas.

**1 Claim, 10 Drawing Sheets**  
**(10 of 10 Drawing Sheet(s) Filed in Color)**

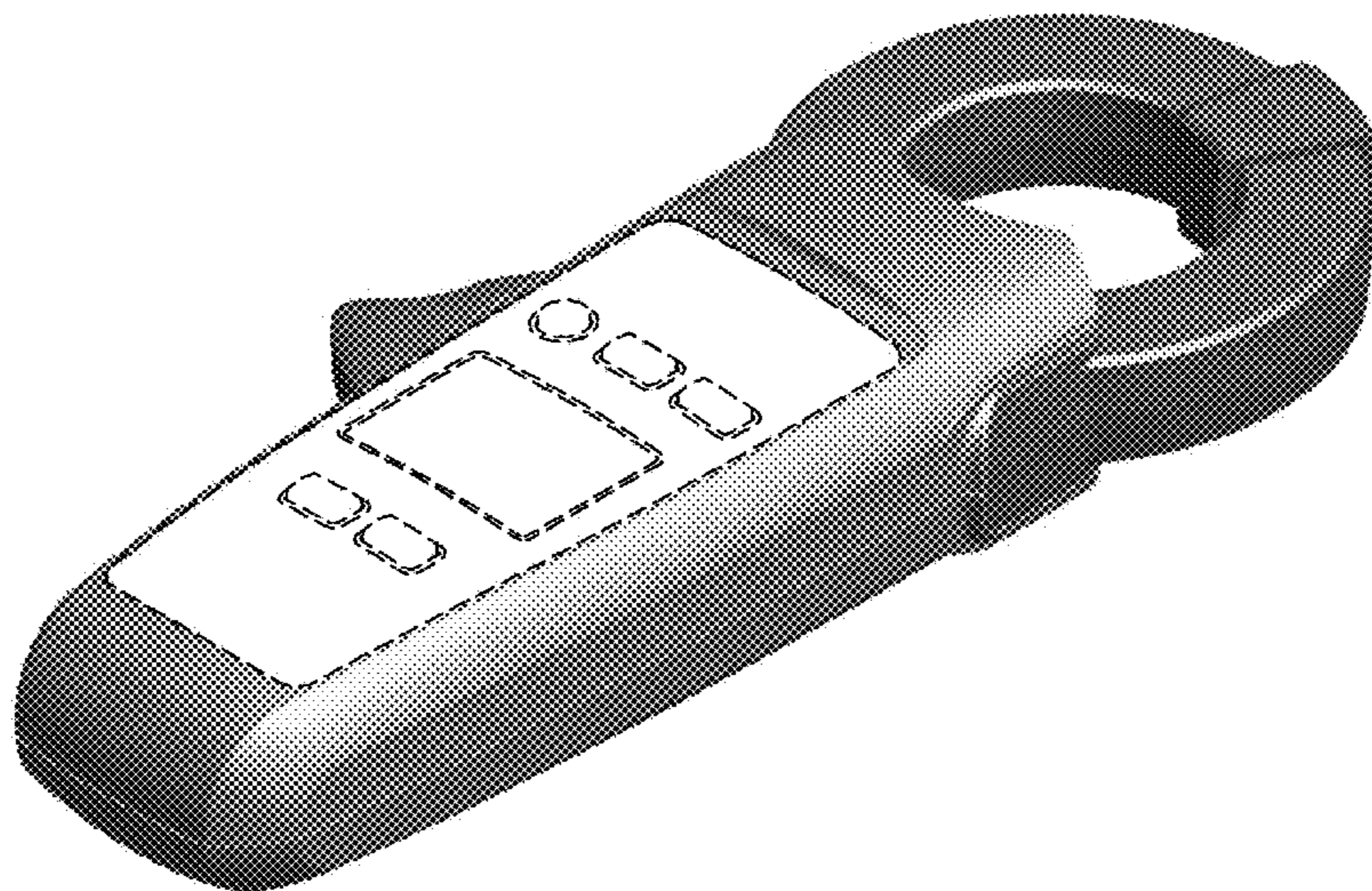

(56)

**References Cited**

U.S. PATENT DOCUMENTS

7,944,197 B2 \* 5/2011 Shah ..... G01R 1/22  
324/115  
8,120,350 B2 \* 2/2012 Shah ..... G01R 1/22  
324/115  
8,330,449 B2 \* 12/2012 Greenberg ..... G01R 15/12  
324/115  
D683,250 S \* 5/2013 Marzynski ..... D10/79  
D684,074 S \* 6/2013 Wei ..... D10/79  
8,570,026 B2 \* 10/2013 Liu ..... G01R 1/04  
324/114  
D715,169 S \* 10/2014 Chen ..... D10/79  
8,856,553 B2 \* 10/2014 Lyakhovitskiy ..... G06F 21/00  
380/277  
8,922,195 B2 \* 12/2014 Worones ..... G01R 1/22  
324/126  
D726,048 S \* 4/2015 Wurts ..... D10/79  
9,366,698 B2 \* 6/2016 Legros ..... G01R 1/20

\* cited by examiner



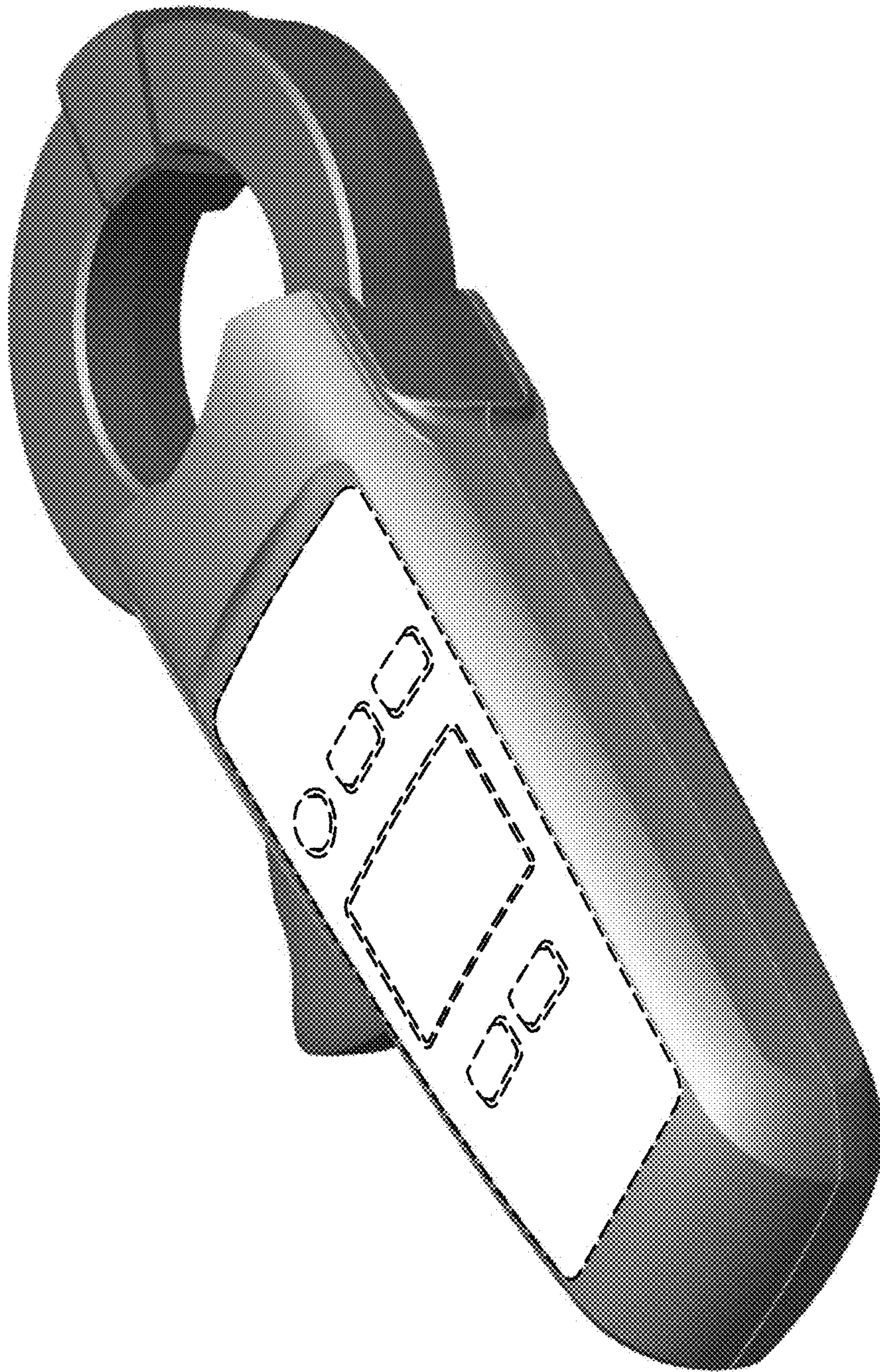

FIG.1



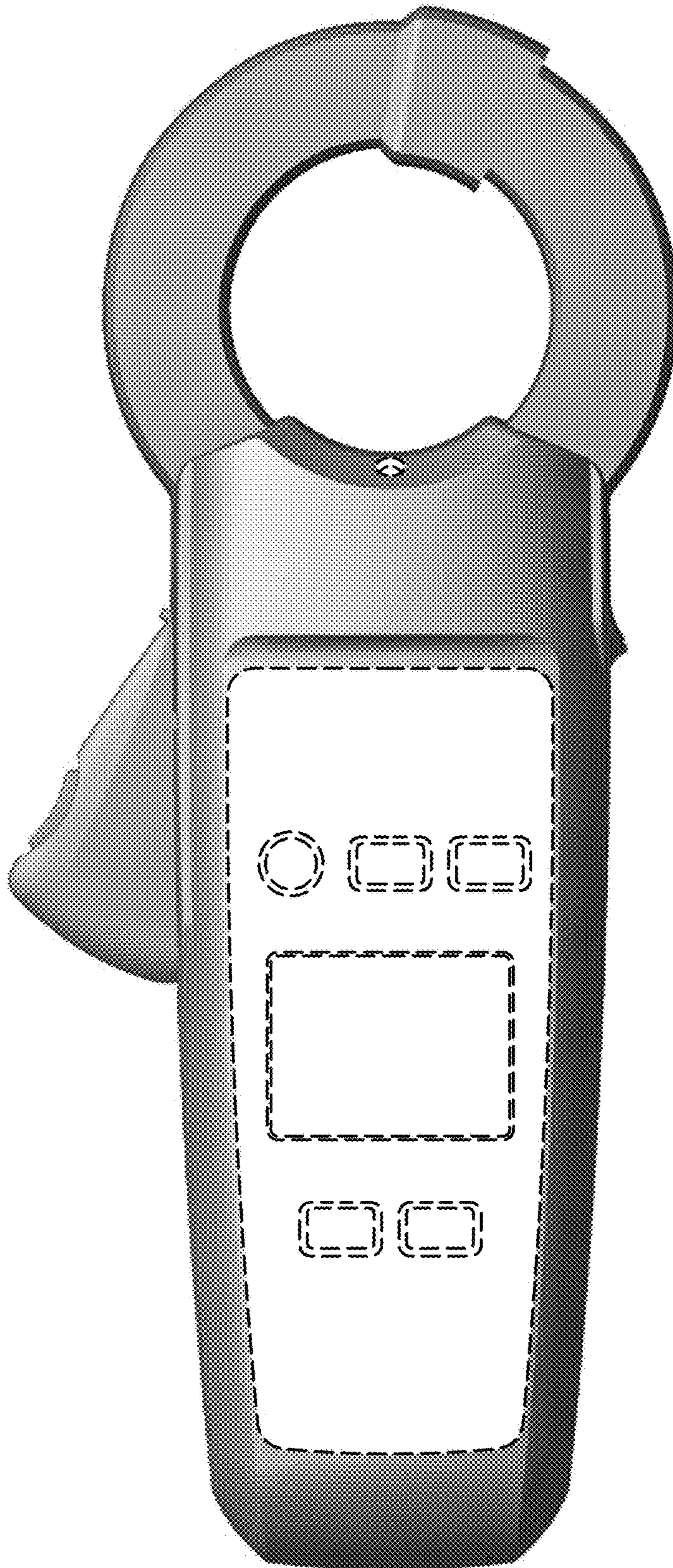

FIG.2





FIG.3



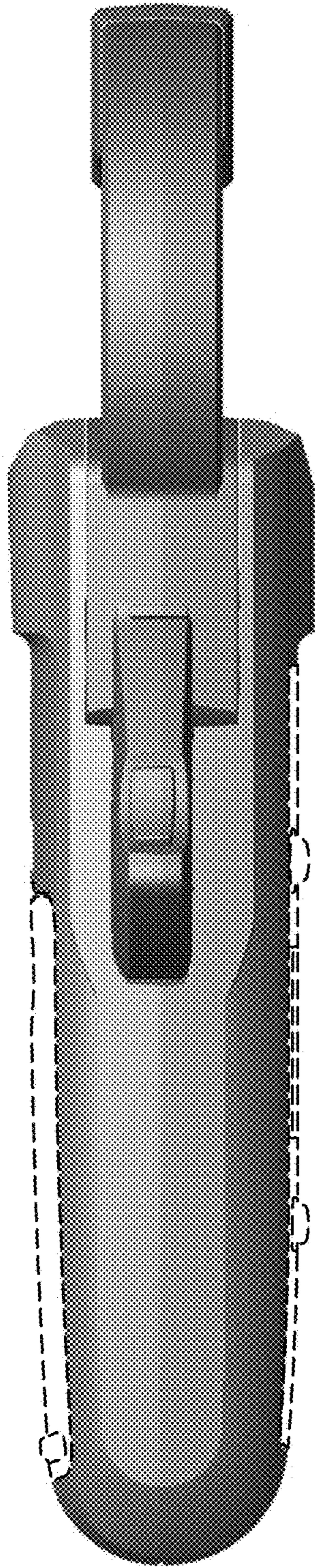

FIG. 4

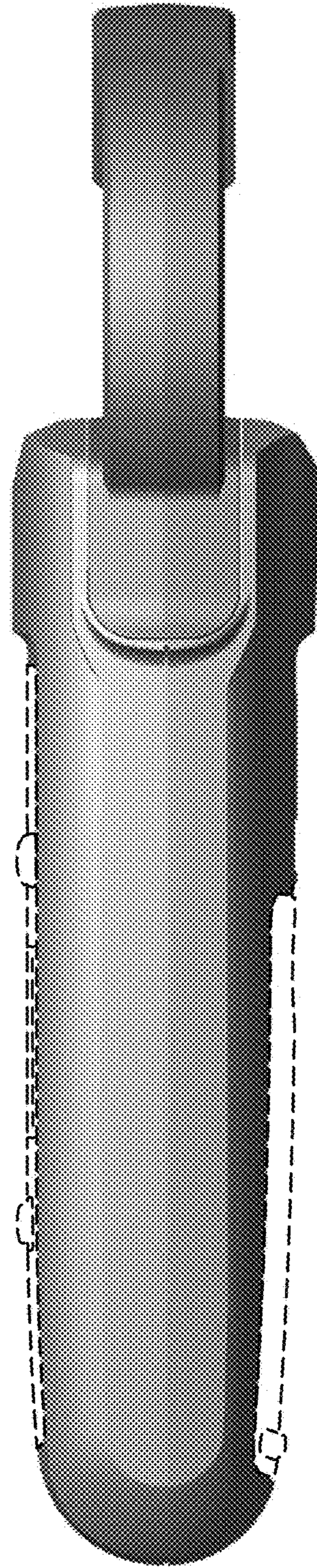

FIG. 5



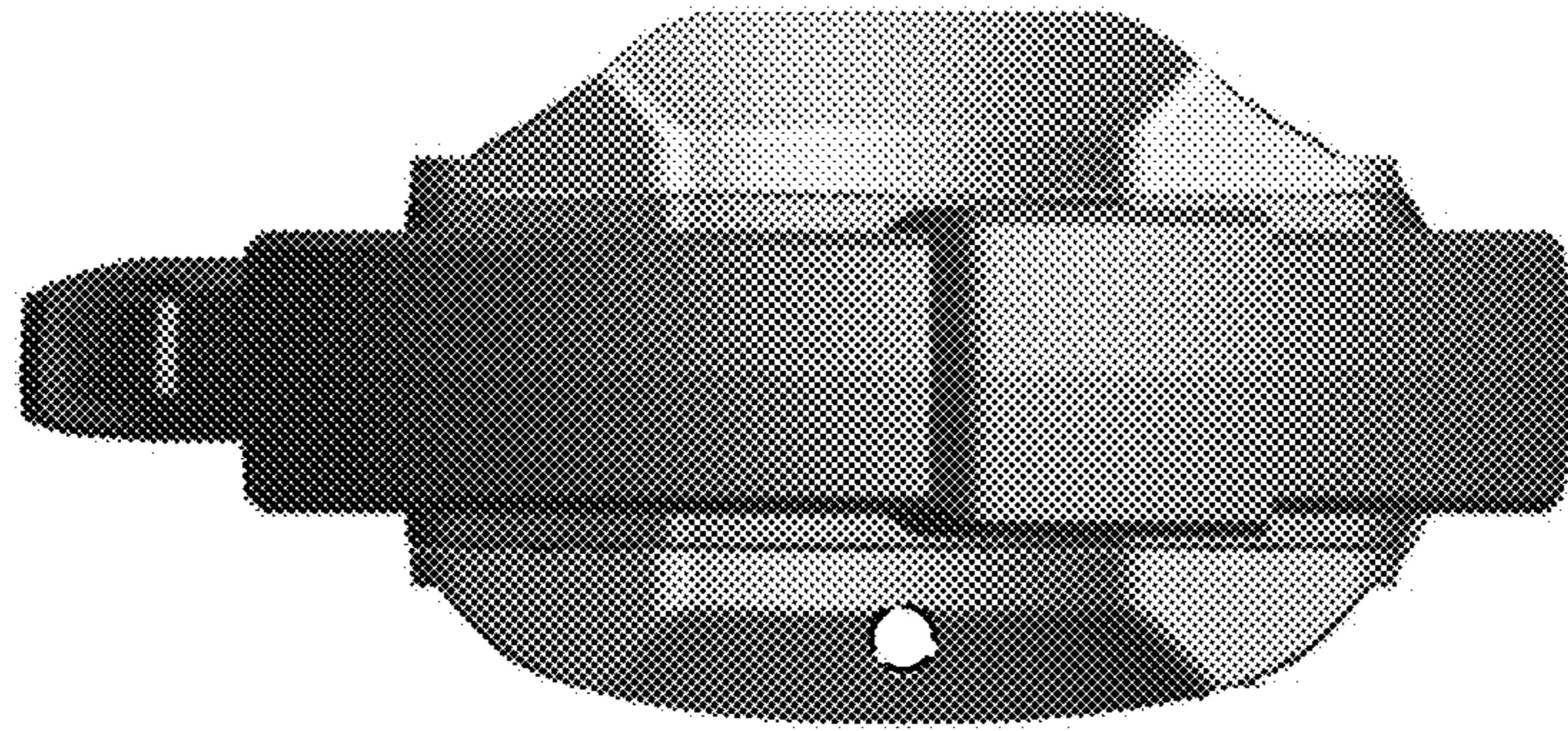

FIG. 6

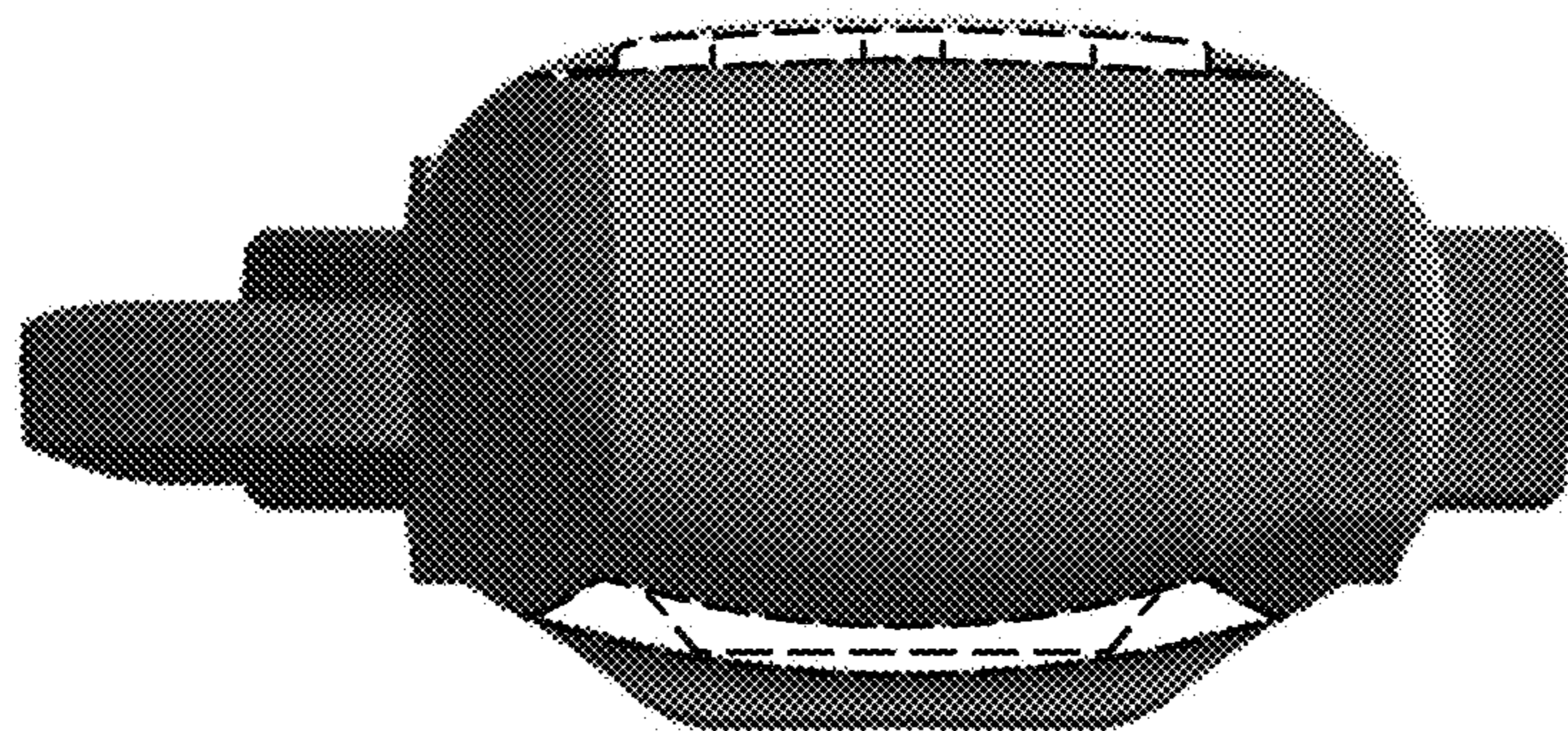

FIG. 7



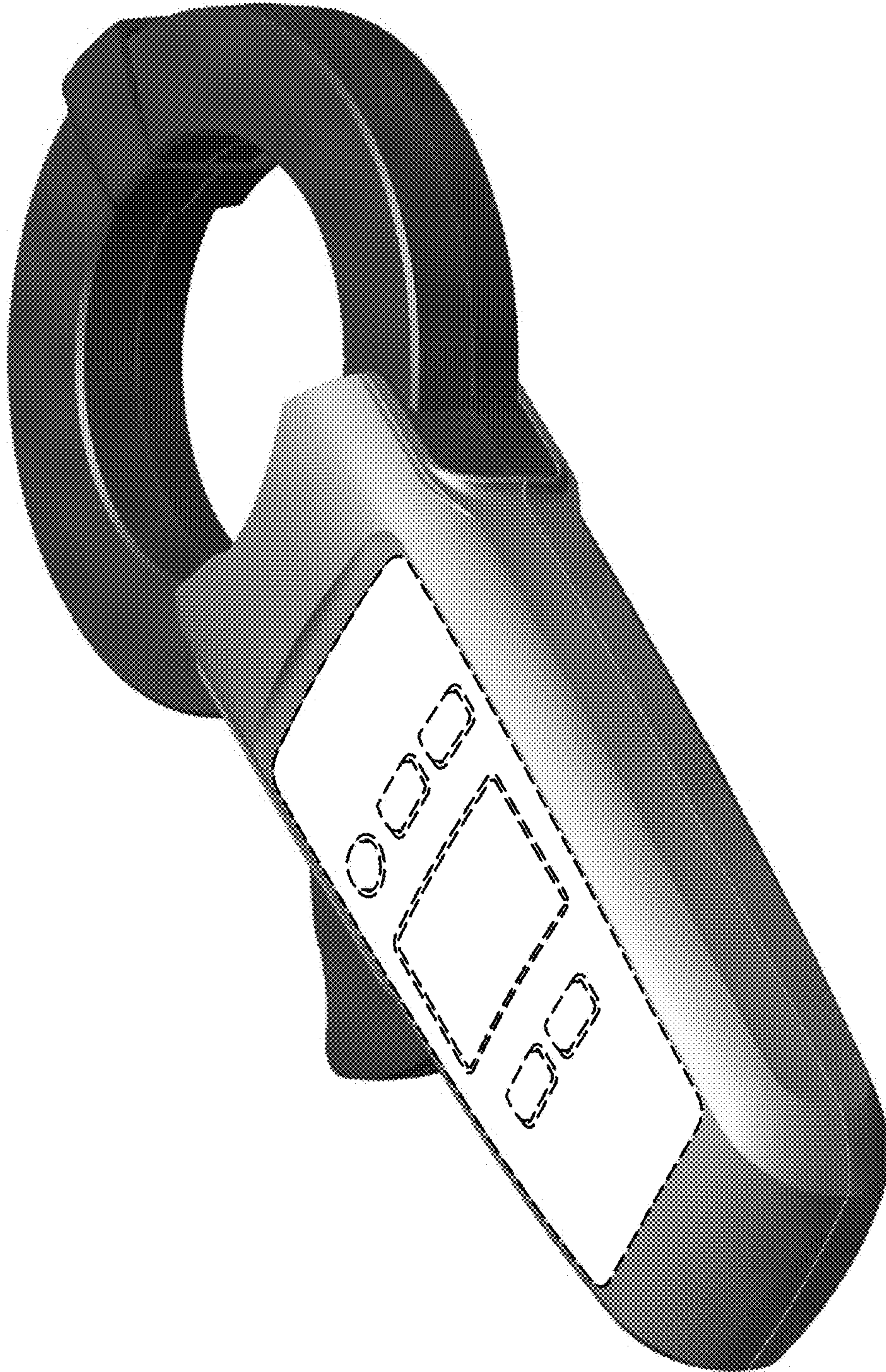

FIG.8



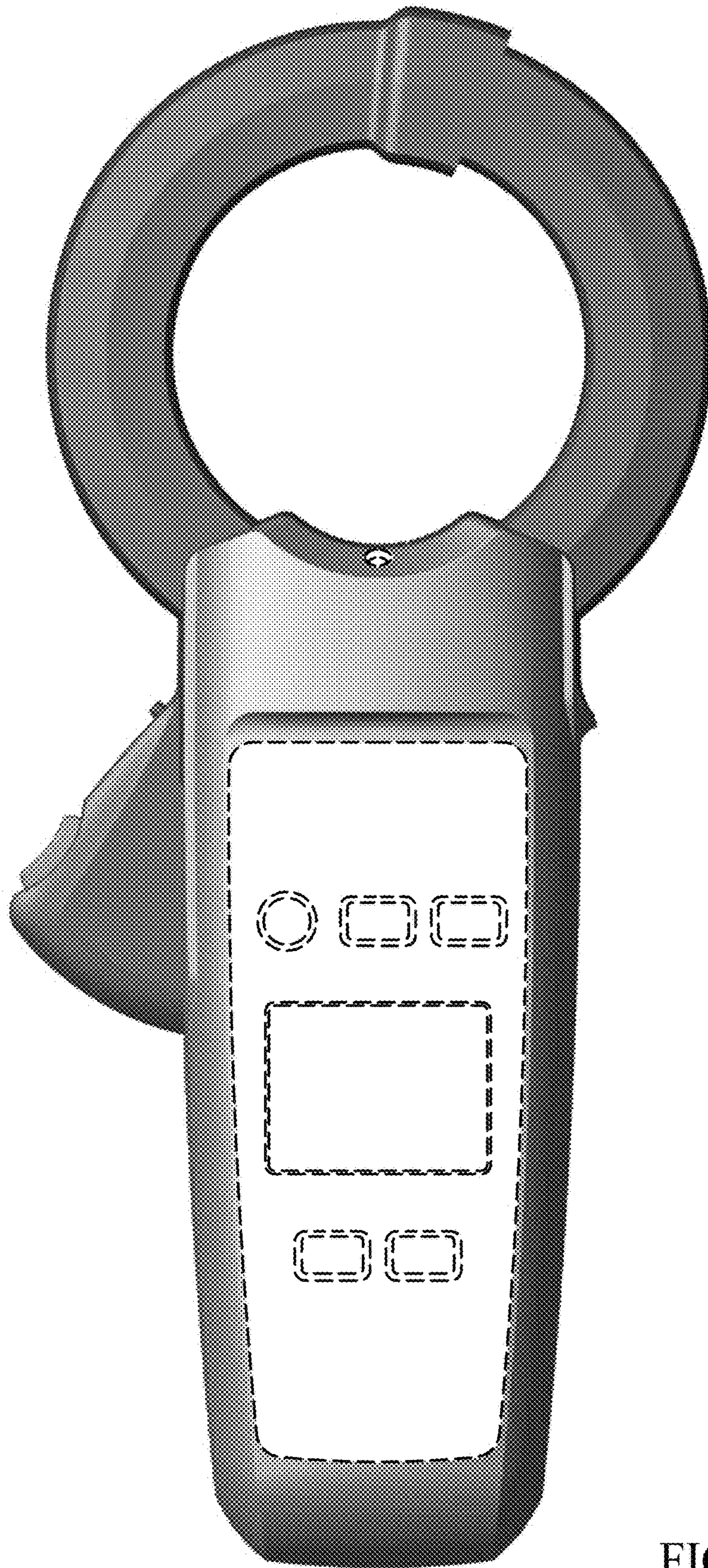

FIG.9





FIG.10



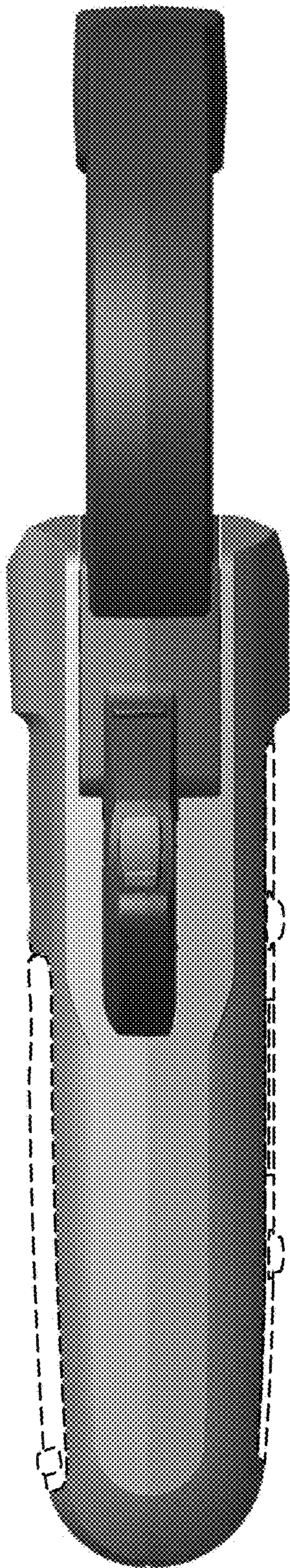

FIG. 11

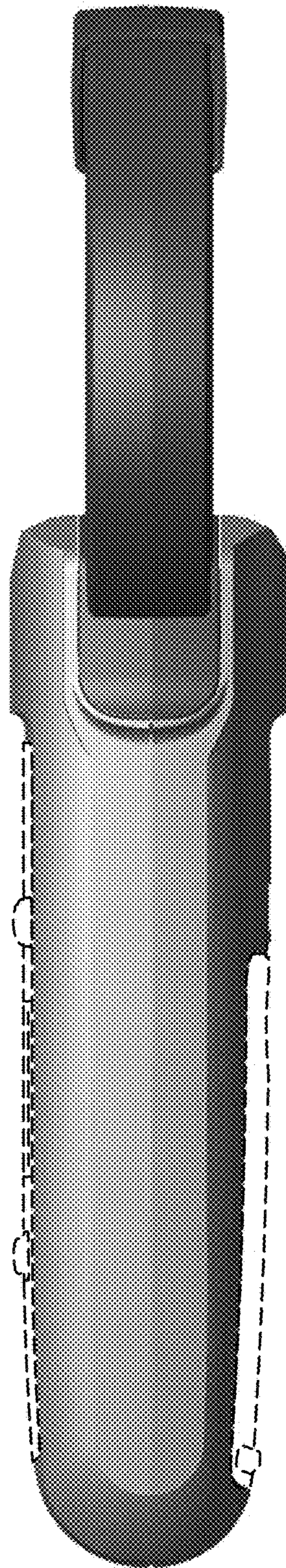

FIG. 12



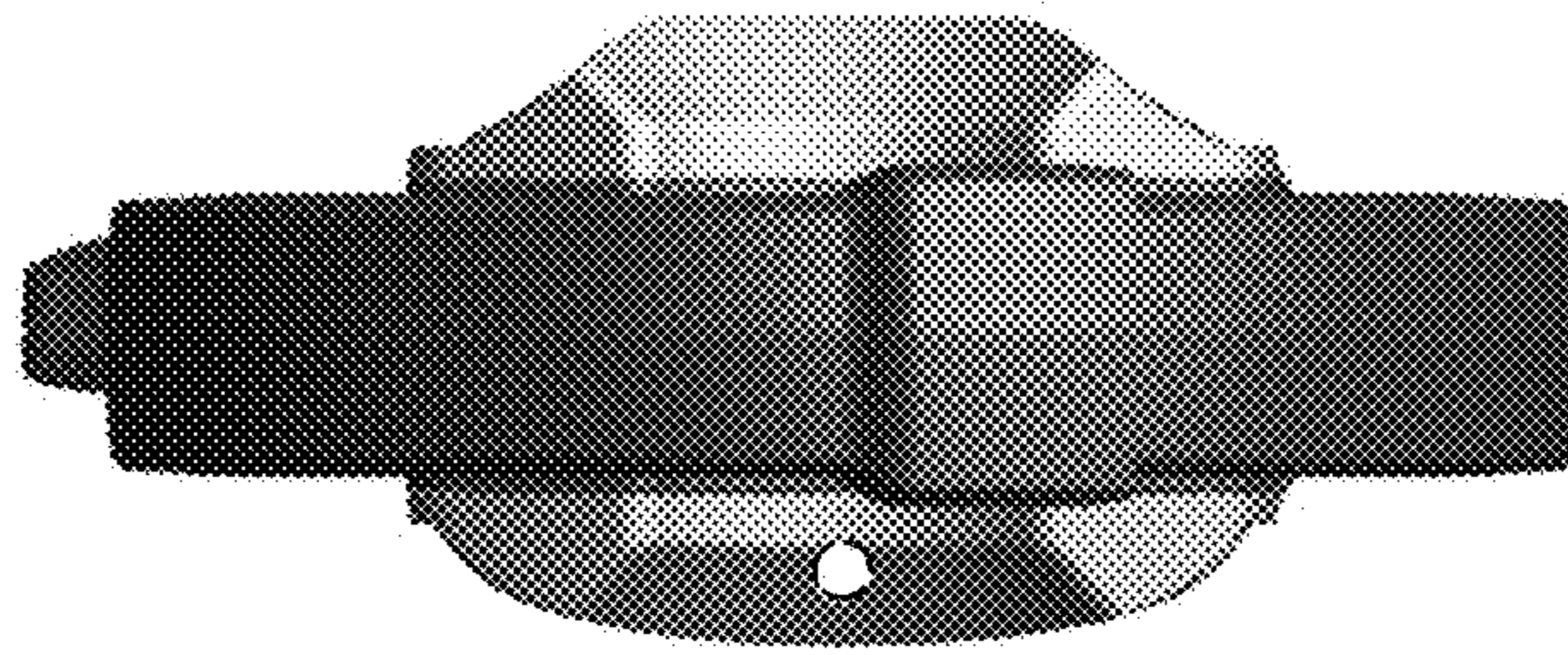

FIG.13

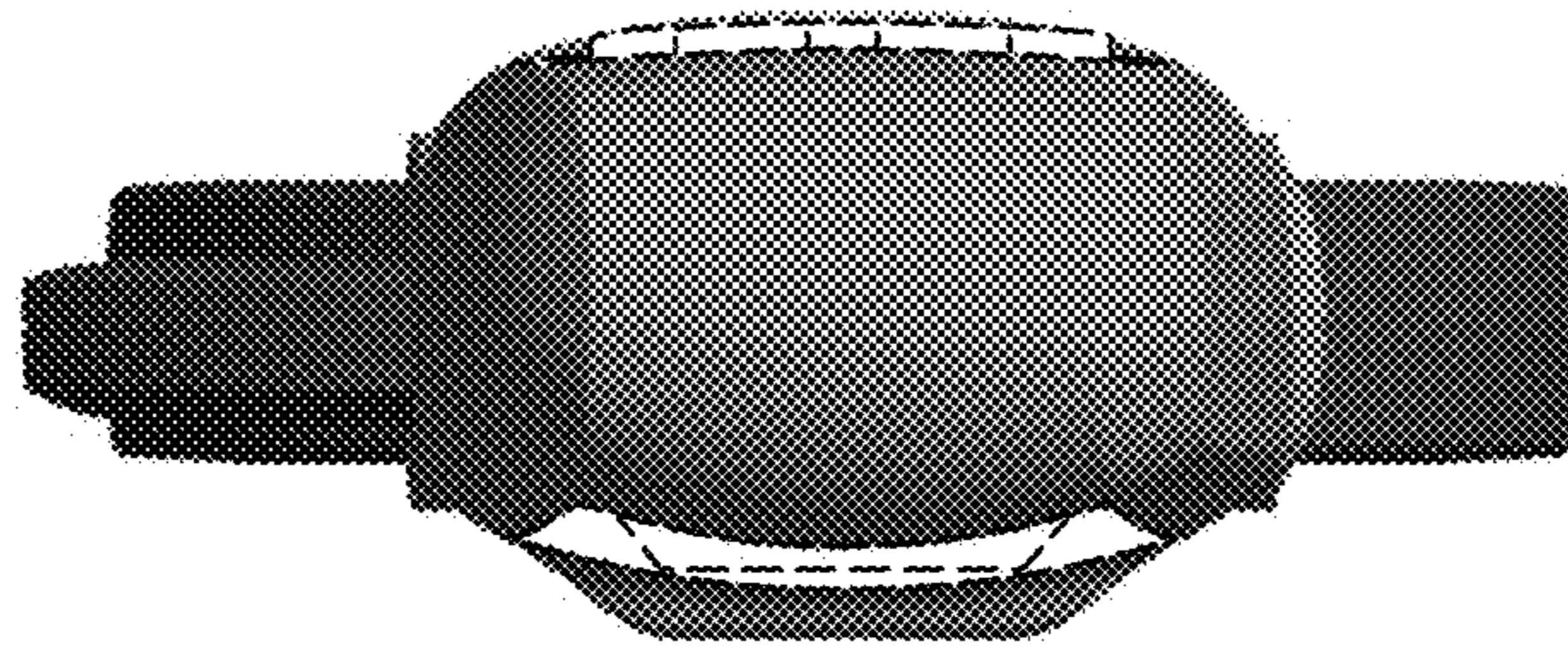

FIG.14