



US00D802443S

(12) **United States Design Patent**  
**Ahlm et al.**

(10) **Patent No.:** **US D802,443 S**  
(45) **Date of Patent:** **\*\* Nov. 14, 2017**

(54) **TWO BOTTLE CONTAINER PACKAGE**  
(71) Applicant: **PRIDE Industries**, Roseville, CA (US)  
(72) Inventors: **Al Ahlm**, Roseville, CA (US); **Steve Twitchell**, Roseville, CA (US)  
(73) Assignee: **Pride Industries**, Roseville, CA (US)  
(\*\*) Term: **15 Years**

(21) Appl. No.: **29/547,311**  
(22) Filed: **Dec. 2, 2015**  
(51) **LOC (10) Cl.** ..... **09-01**  
(52) **U.S. Cl.**  
USPC ..... **D9/744**  
(58) **Field of Classification Search**  
USPC ..... D9/741, 516, 529, 559, 564-565,  
D9/561-562, 575, 737-738, 686, 689,  
D9/691, 693, 570, 574, 747, 569, 573,  
D9/620, 341, 367, 751, 756, 530, 313,  
D9/375, 403, 409, 413, 558, 547, 743,  
(Continued)

(56) **References Cited**  
**U.S. PATENT DOCUMENTS**  
D100,412 S \* 7/1936 Carp ..... 215/6  
3,443,726 A 5/1969 Muller et al.  
(Continued)

**OTHER PUBLICATIONS**  
PRIDEClean, available Jan. 8, 2017, [online], [site visited Jan. 8, 2017]. Available from internet, <URL: <http://www.pridecleaneco.com/>>.\*  
(Continued)

*Primary Examiner* — Cathron Brooks  
*Assistant Examiner* — Teddy Falloway

(74) *Attorney, Agent, or Firm* — Pillsbury Winthrop Shaw Pittman LLP

(57) **CLAIM**  
We claim the ornamental design for a two-bottle container package, as shown and described.

**DESCRIPTION**  
This design patent application is related to U.S. patent application Ser. No. 14/957,305 filed Dec. 2, 2015 entitled “Two Bottle Container”, which application is incorporated herein by reference.  
FIG. 1 is a front perspective view of the two bottle container package in accordance with an embodiment of the present invention.  
FIG. 2 is a rear perspective view thereof.  
FIG. 3 is an alternate front perspective view thereof.  
FIG. 4 is an alternate rear perspective view thereof.  
FIG. 5 is a front view of a first part thereof, rear view is a mirror image.  
FIG. 6 is a right side view of the first part of the two bottle container package, shown separately for completeness of illustration.  
FIG. 7 is the left side view of the first part thereof.  
FIG. 8 is a top view of the first part thereof.  
FIG. 9 is a bottom view of the first part thereof.  
FIG. 10 is an elevational section view of FIG. 8.  
FIG. 11 is a perspective view of the second part of the two bottle container package, shown separately for completeness of illustration.  
FIG. 12 is front view of a second part thereof, rear view is a mirror image.  
FIG. 13 is a right side view of a second part thereof.  
FIG. 14 is a left side view of a second part thereof.  
FIG. 15 is a top view of a second part thereof.  
FIG. 16 is a bottom view of a second part thereof; and, FIG. 17 is an elevational section view of FIG. 15.  
The broken lines shown in the drawings illustrate portions of the two bottle container package that form no part of the claimed design.

**1 Claim, 10 Drawing Sheets**

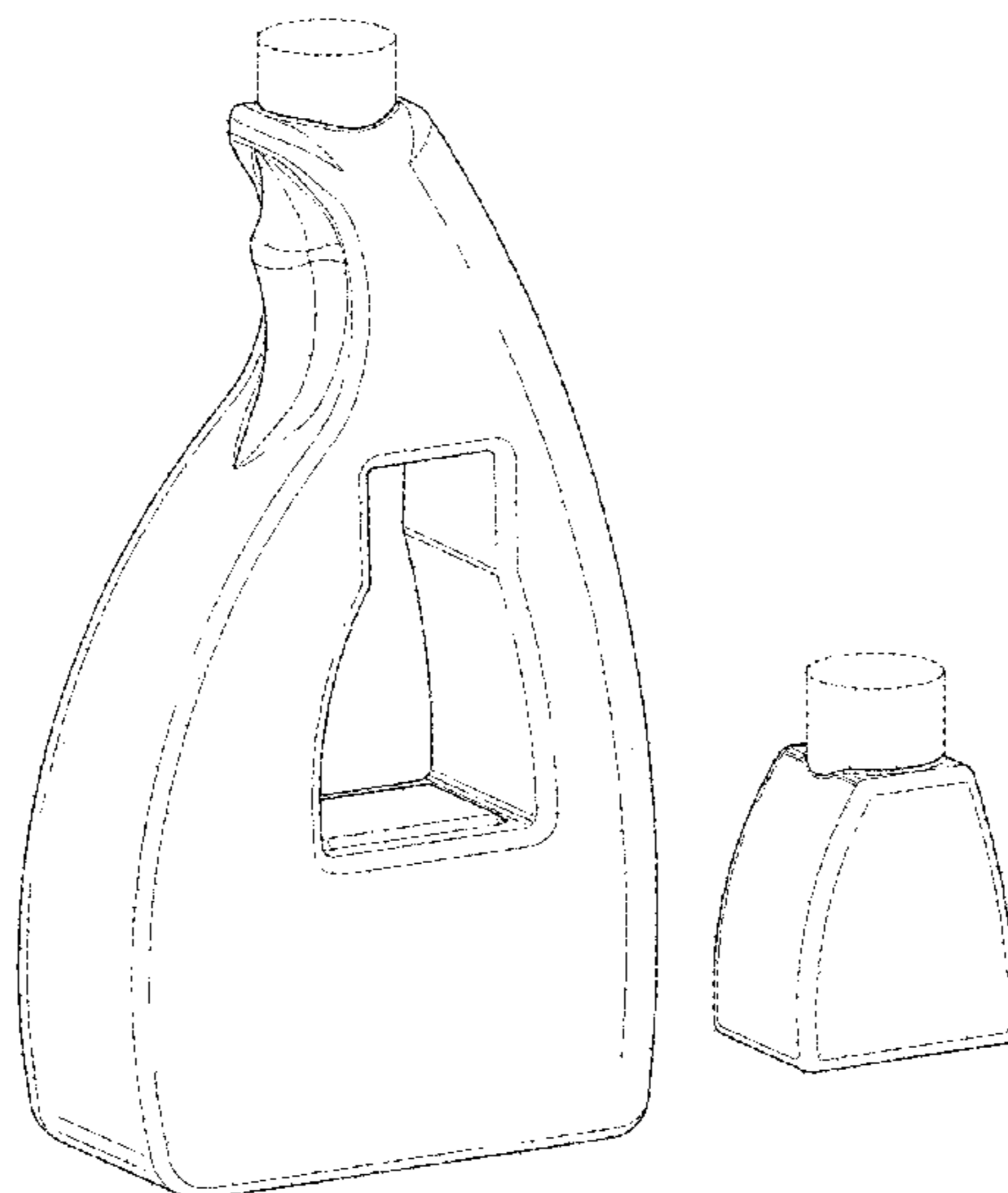

(58) **Field of Classification Search**

USPC ..... D9/744, 539–546, 520–524;  
 D7/509–511, 563, 573, 513, 300, 308,  
 D7/312, 315, 601, 602, 619.1, 622;  
 D3/202; 264/532; 222/129, 94, 135;  
 220/505, 504, 288, 709, 23.4, 23.8, 23.88,  
 220/633, 916, 660, 669; 215/6, 10, 1 R,  
 215/1 C, 379, 381–384  
 CPC ..... B65D 1/04; B65D 21/02; B65D 21/0201;  
 B65D 81/3283; B65D 2501/0081; B65D  
 81/3244; B65D 83/40; B65D 83/68  
 See application file for complete search history.

(56) **References Cited**

U.S. PATENT DOCUMENTS

4,235,343 A \* 11/1980 Thompson ..... B65D 21/0237  
 215/10  
 4,592,478 A \* 6/1986 Laconis ..... B65D 1/02  
 206/77.1  
 4,823,946 A 4/1989 Stoeffler et al.  
 D303,087 S \* 8/1989 Gendron ..... D9/528  
 D310,958 S \* 10/1990 Biesecker ..... D9/549  
 5,050,757 A \* 9/1991 Hidding ..... B65D 23/12  
 215/383  
 D325,340 S \* 4/1992 Balavich ..... D9/744  
 D325,341 S \* 4/1992 Balavich ..... D9/445  
 D338,824 S \* 8/1993 Chen ..... D9/516  
 5,277,303 A 1/1994 Goyet et al.  
 D345,303 S \* 3/1994 Sykes ..... D9/528  
 D362,799 S \* 10/1995 Noble ..... D9/522  
 D379,310 S \* 5/1997 Balz ..... D9/523  
 D380,148 S \* 6/1997 Hauf ..... D9/528  
 D403,588 S \* 1/1999 Jungmann ..... D9/523

D427,912 S \* 7/2000 Johnson ..... D9/528  
 D469,357 S \* 1/2003 Verherbrugghen ..... D9/516  
 D479,985 S \* 9/2003 Lowance ..... D9/742  
 D494,069 S \* 8/2004 Mayne ..... D9/528  
 D500,680 S \* 1/2005 Angeletta ..... D9/528  
 D543,855 S \* 6/2007 Cardinal ..... D9/524  
 RE39,718 E \* 7/2007 Mayne ..... D9/528  
 D593,416 S \* 6/2009 Medema ..... D9/523  
 D602,379 S \* 10/2009 Traiforos ..... D9/685  
 D608,644 S \* 1/2010 Cordero ..... D9/516  
 D663,212 S \* 7/2012 DiBiasio ..... D9/528  
 D692,776 S \* 11/2013 Burgeson ..... D9/448  
 D693,691 S \* 11/2013 Nachtsheim ..... D9/523  
 D703,539 S \* 4/2014 Williams ..... D9/523  
 D718,634 S \* 12/2014 DiBiasio ..... D9/516  
 D722,879 S \* 2/2015 Castillo Higareda ..... D9/528  
 D722,882 S \* 2/2015 Castillo Higareda ..... D9/543  
 D761,111 S \* 7/2016 Hart ..... D9/520  
 D766,111 S \* 9/2016 Henshaw ..... D9/528  
 D774,913 S \* 12/2016 Schwartz ..... D9/543  
 2005/0067414 A1 \* 3/2005 Lipson ..... B29C 49/54  
 220/23.86

OTHER PUBLICATIONS

“Pride cleaning products hit Walmart shelves” (via bizjournals), available Jan. 7, 2013, [online], [site visited Jan. 8, 2017]. Available from internet, <URL: <http://www.bizjournals.com/sacramento/blog/kelly-johnson/2013/01/pride-cleaning-products-walmart-shelves.html#i1>>.\*  
 “Nested Detergent Bottle Integrates a Sprayer, a Squeegee and a Container” (via trendhunter), available Jan. 30, 2015, [online], [site visited Jan. 8, 2017]. Available from internet, <URL: <http://www.trendhunter.com/trends/nested-detergent-bottle>>.\*

\* cited by examiner

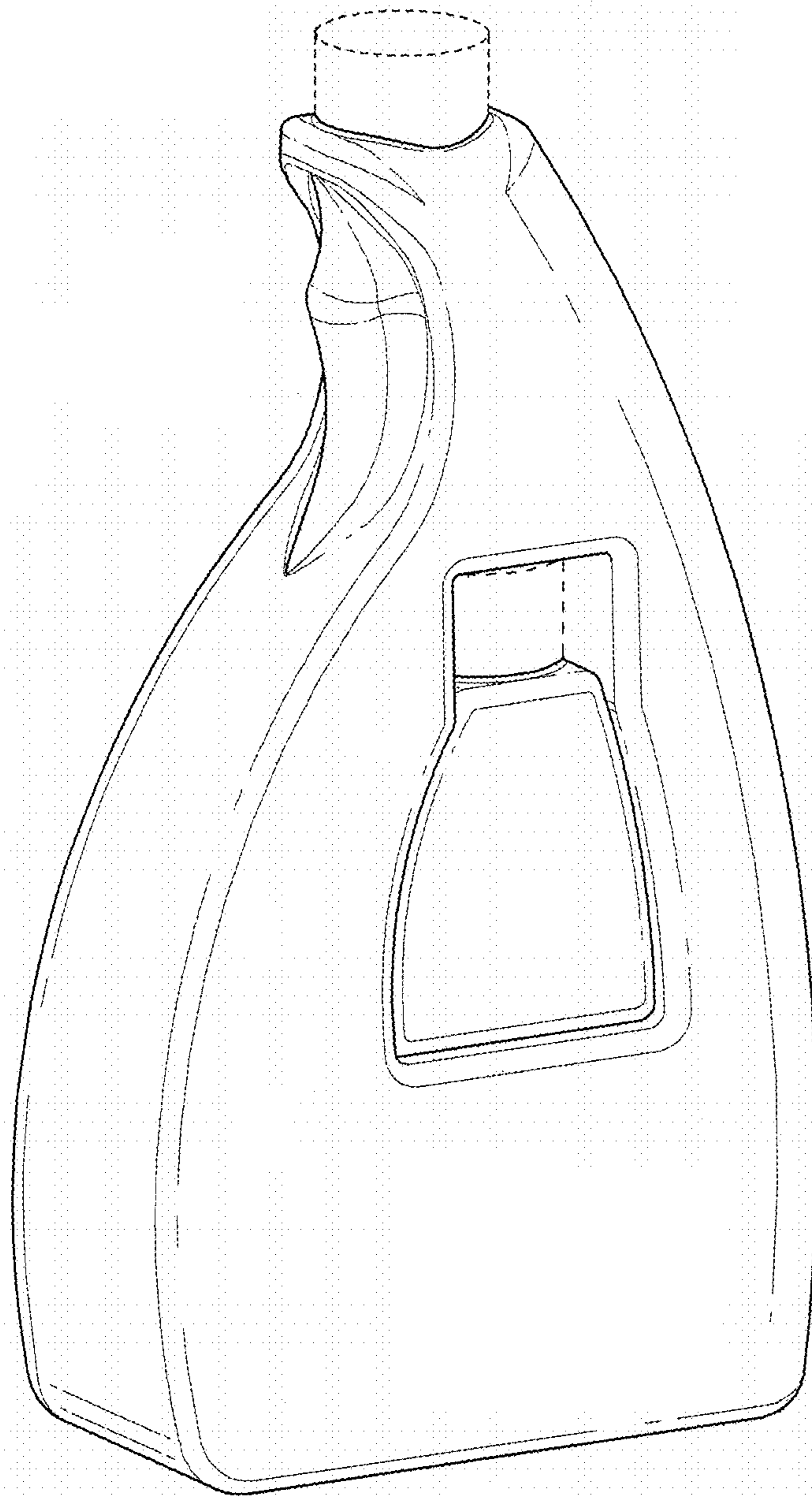

FIG. 1

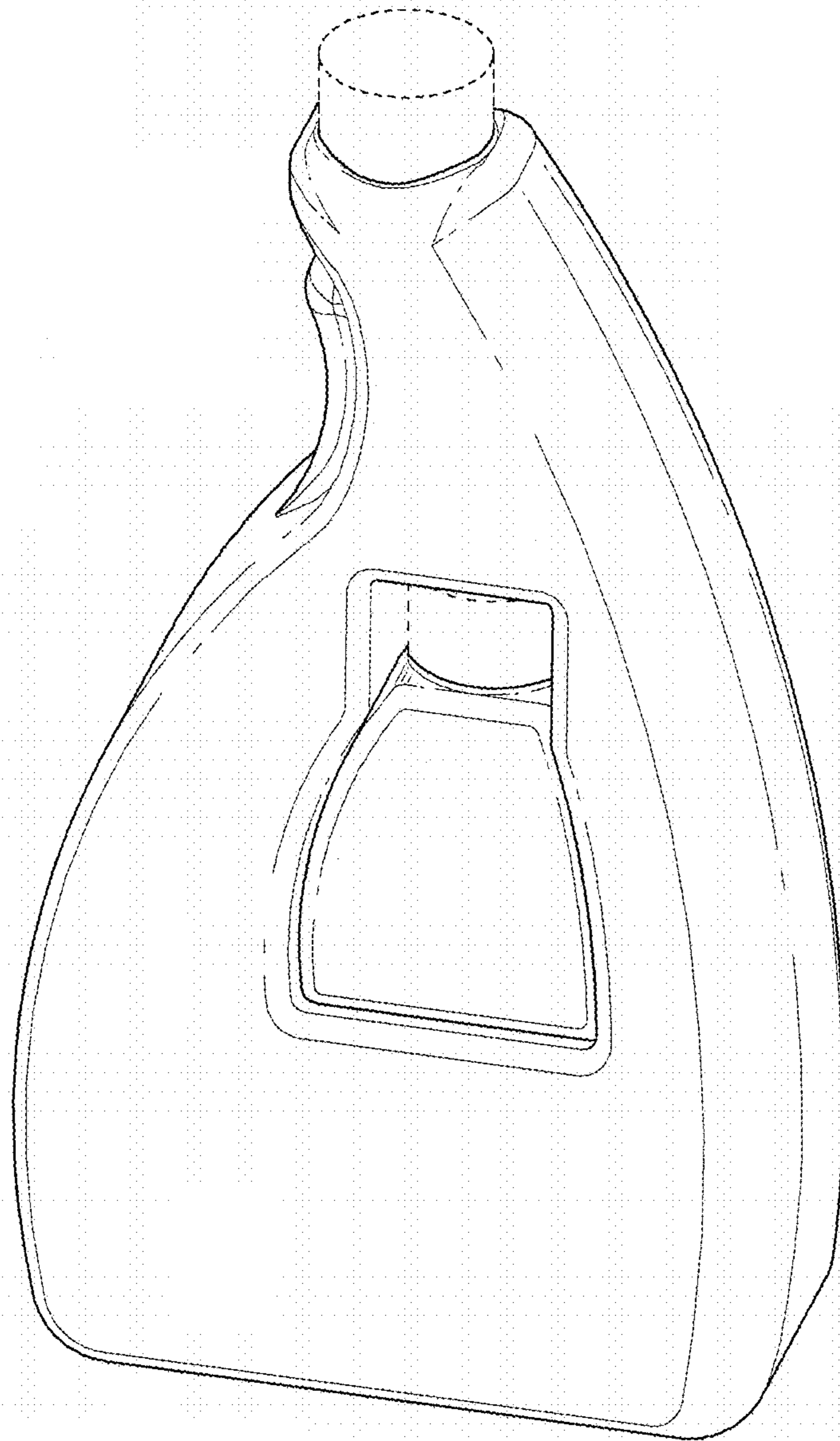

FIG. 2

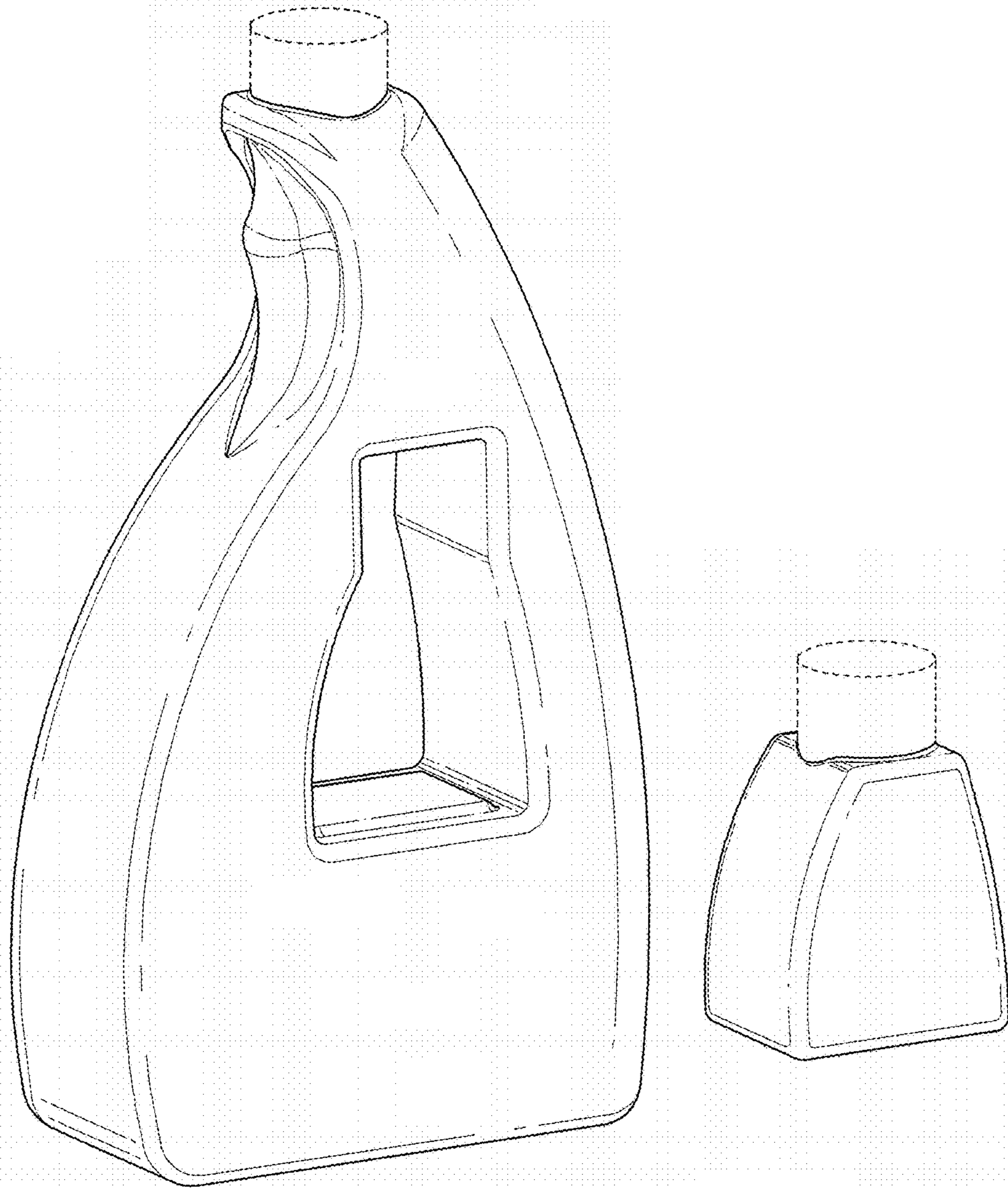

FIG. 3

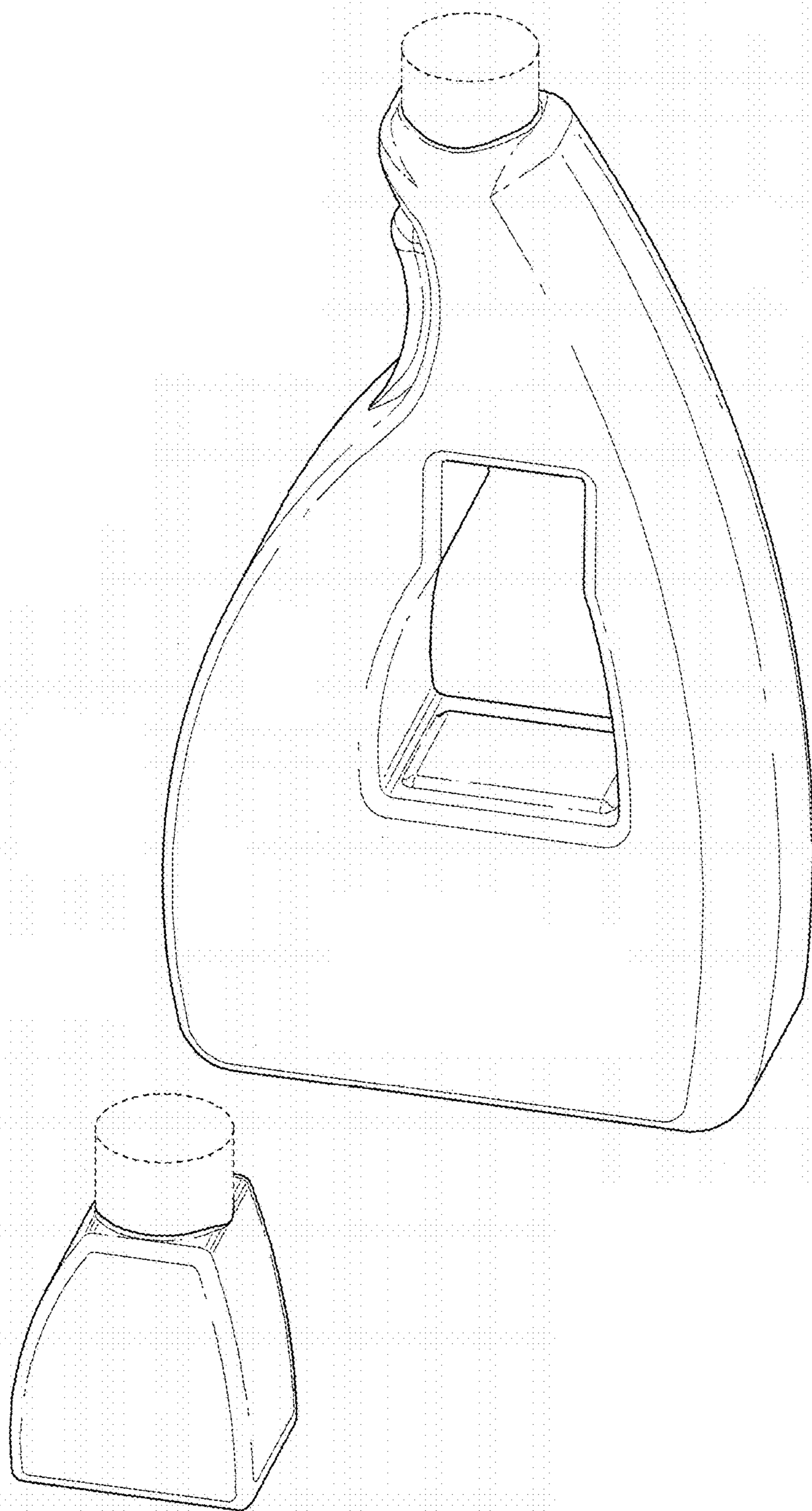

FIG. 4

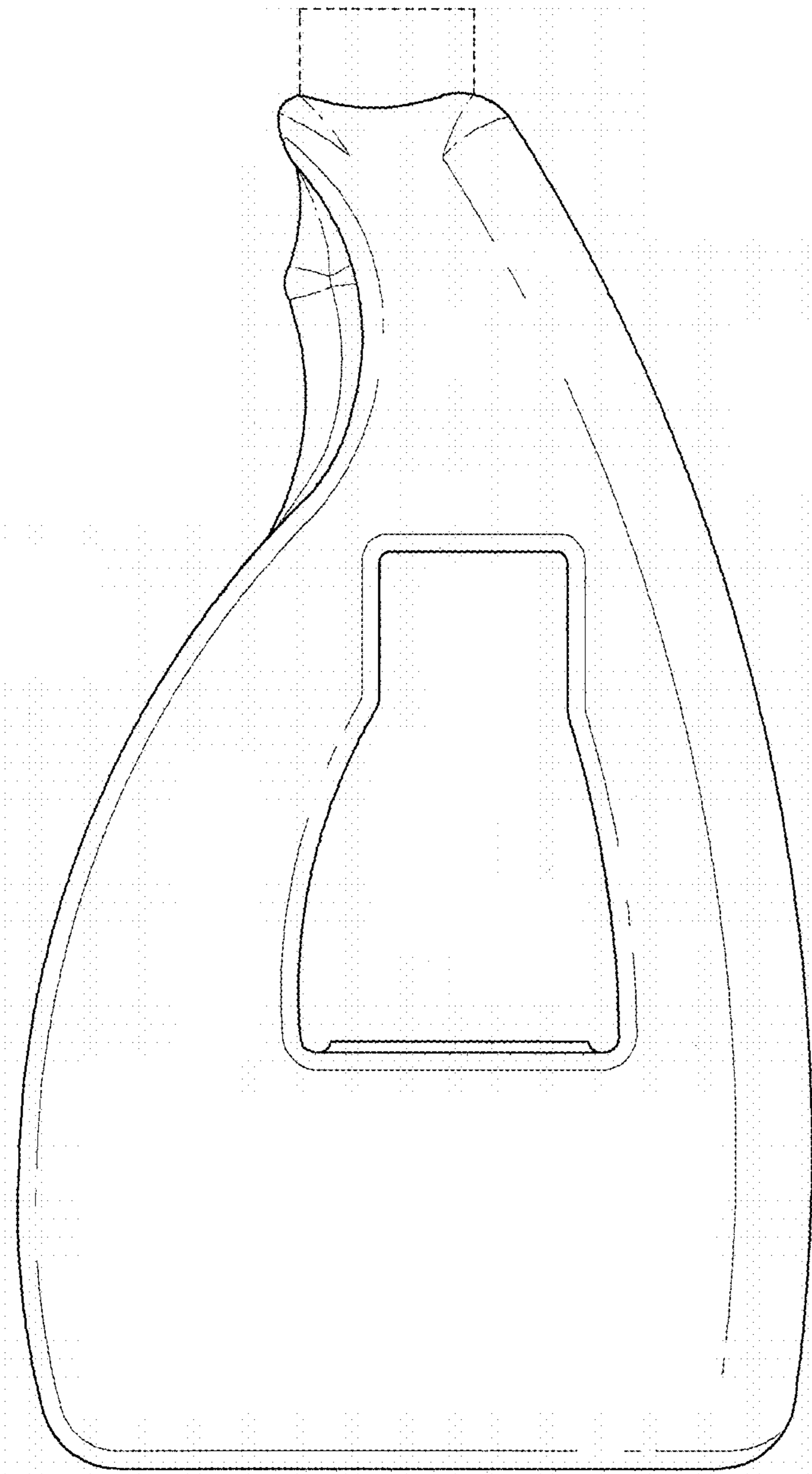

FIG. 5

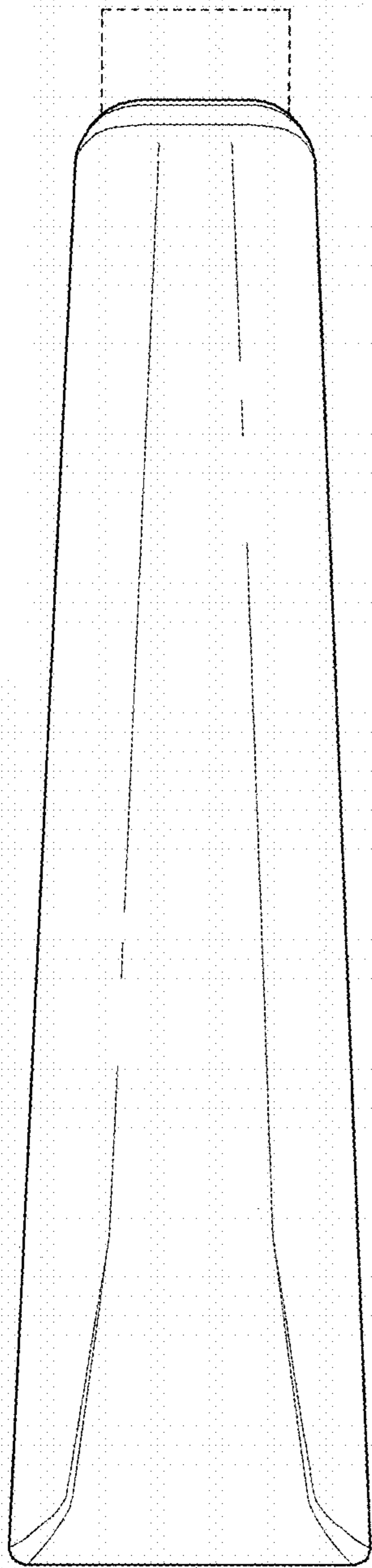

FIG. 6

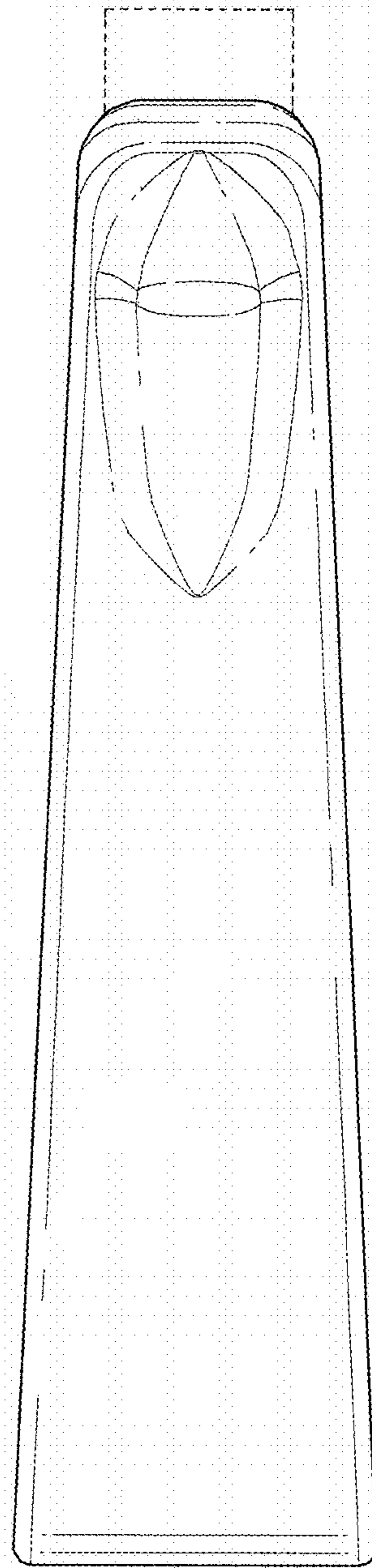

FIG. 7



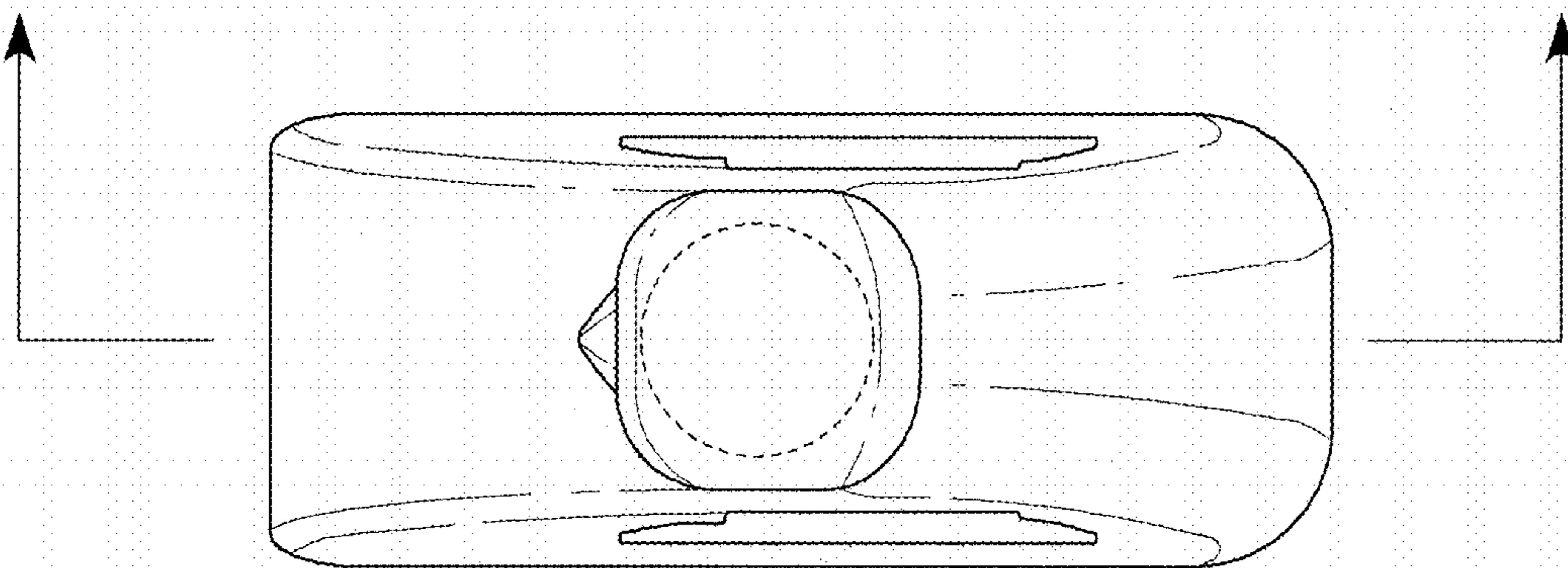

FIG. 8

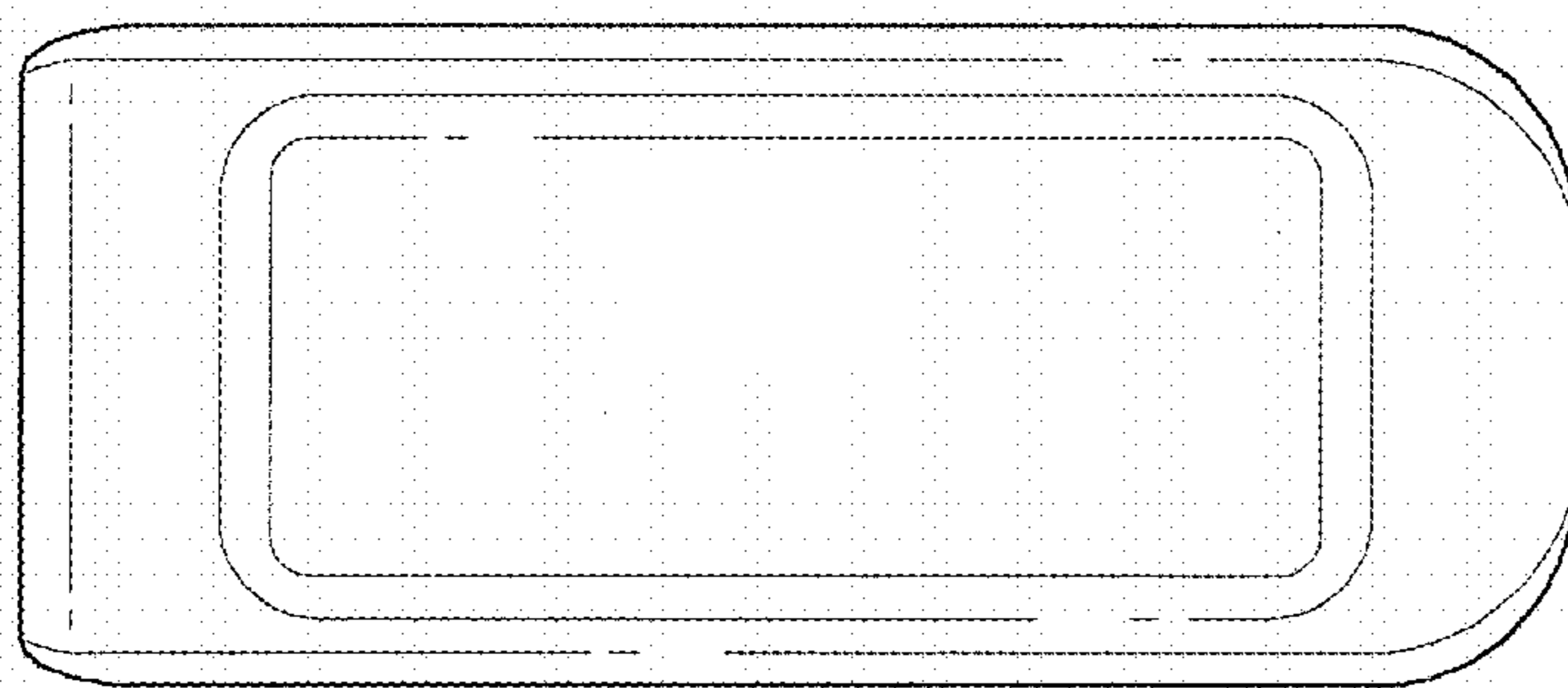

FIG. 9

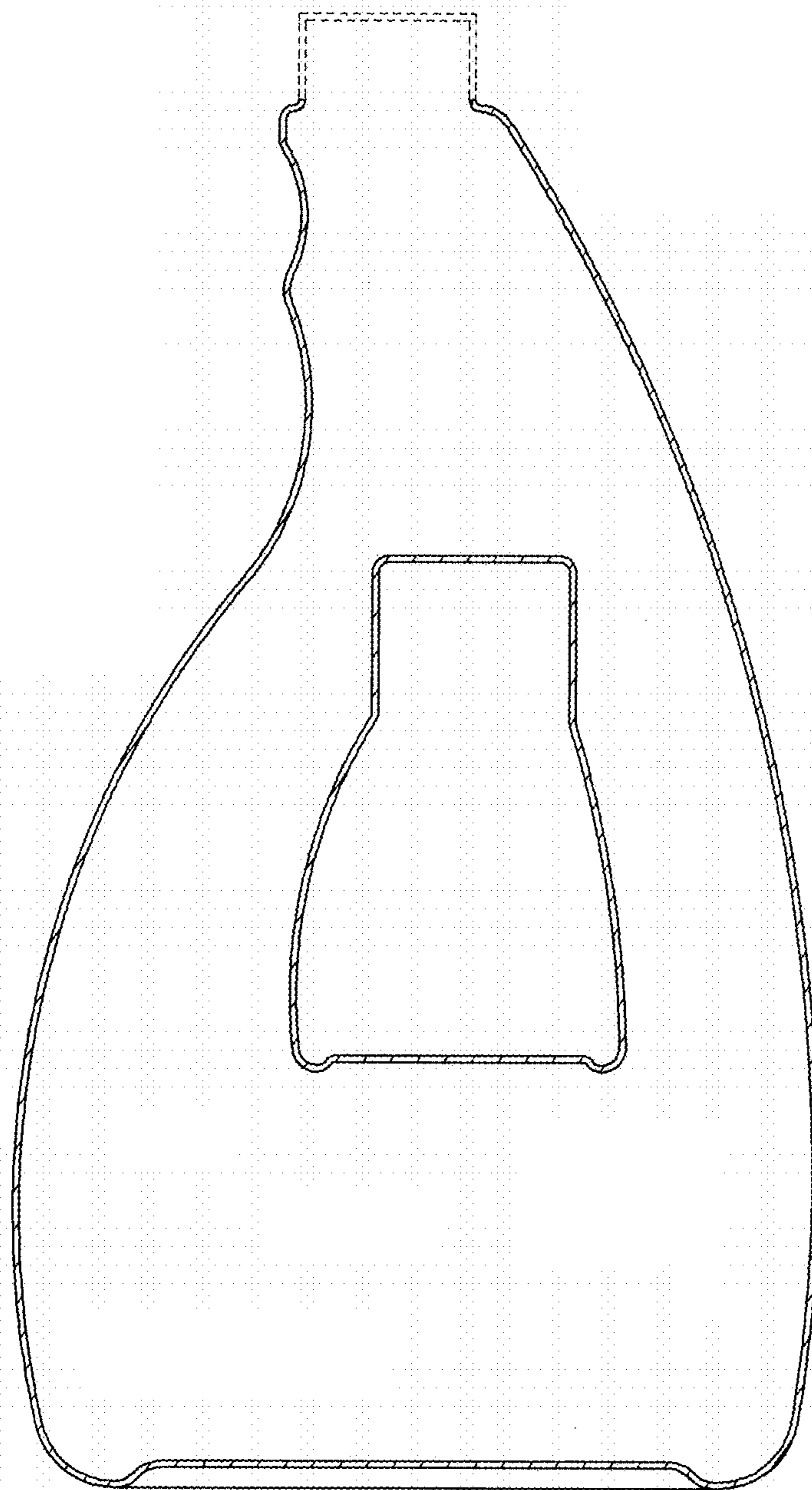

FIG. 10

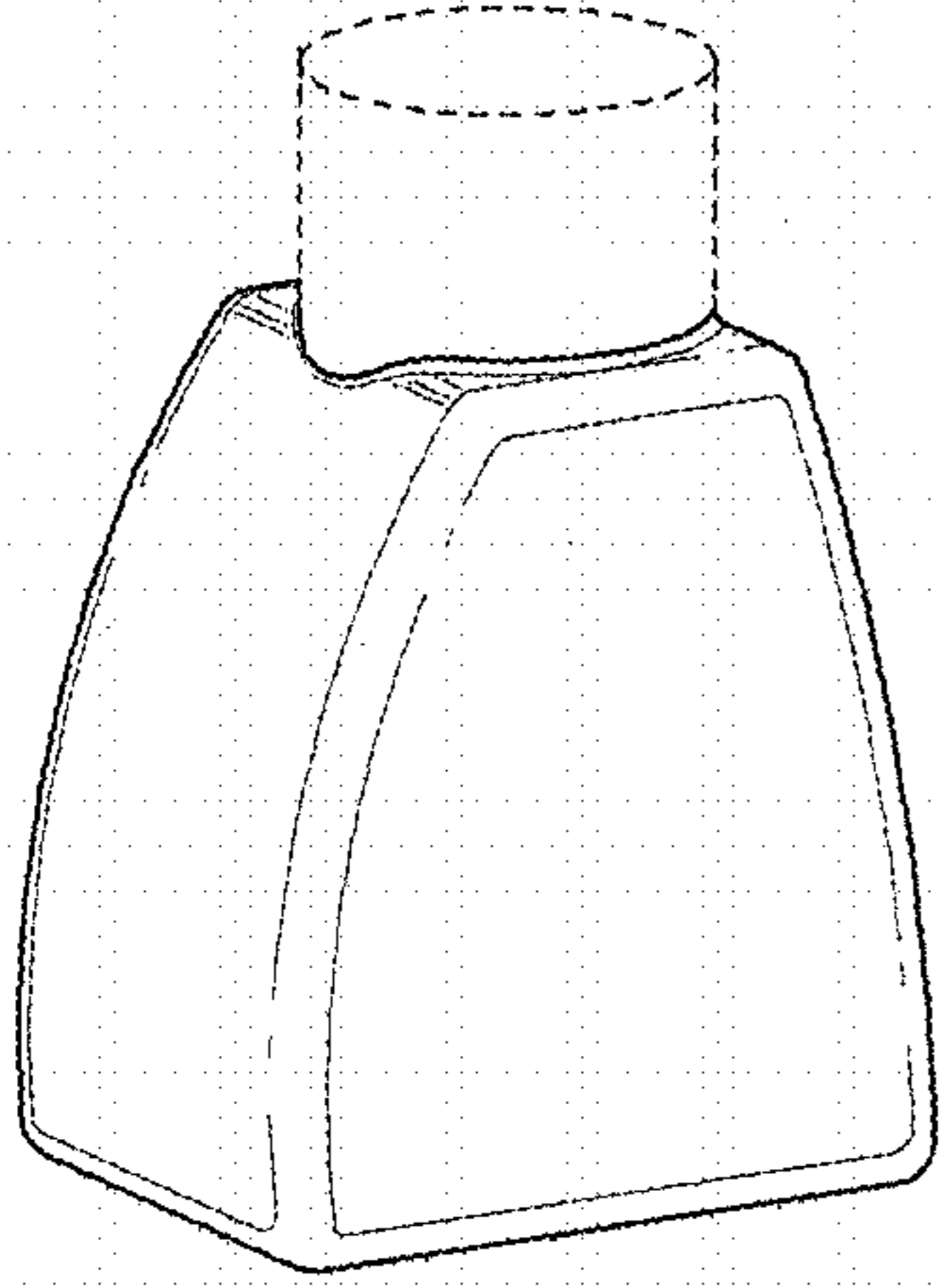

FIG. 11

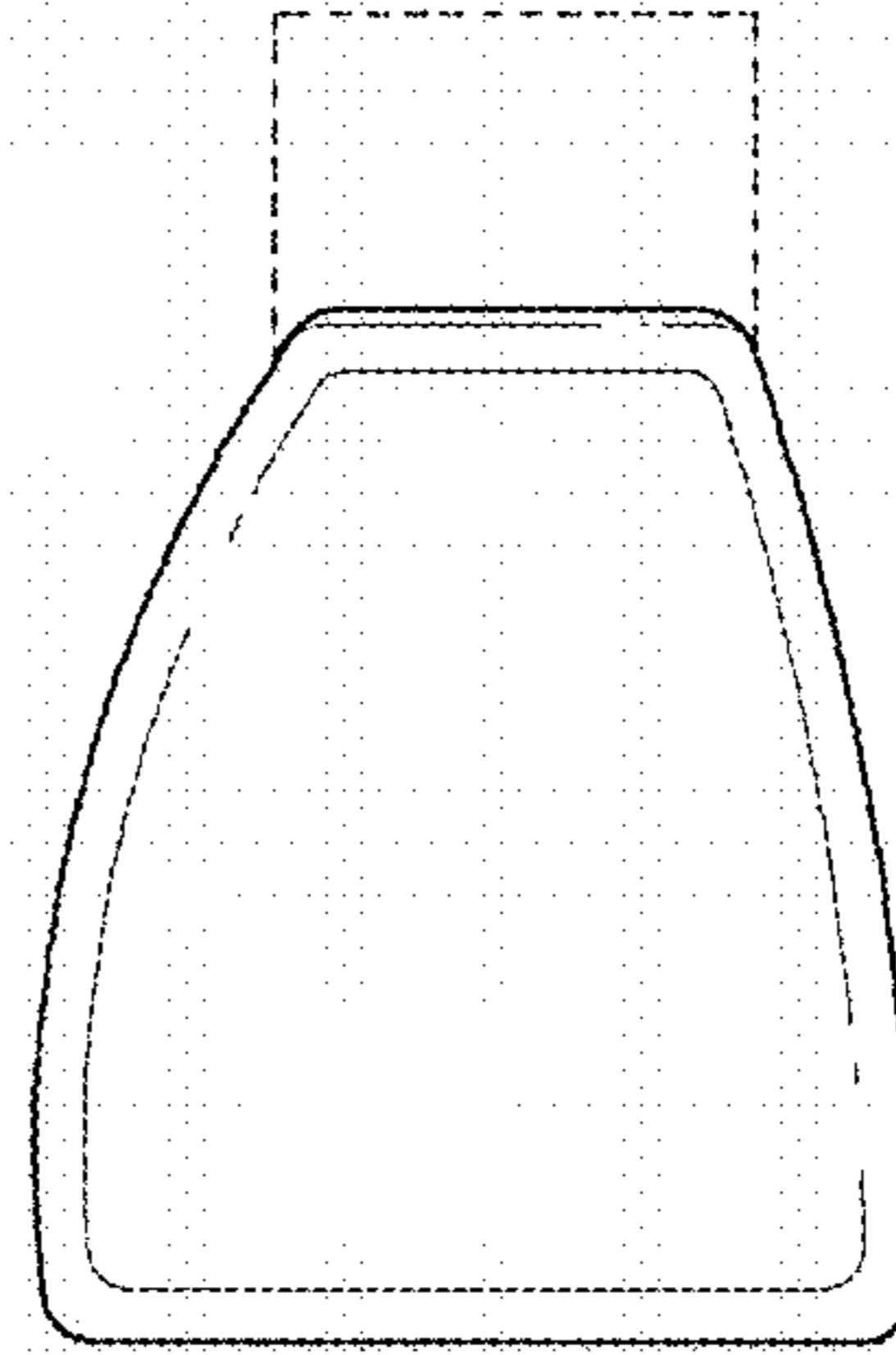

FIG. 12

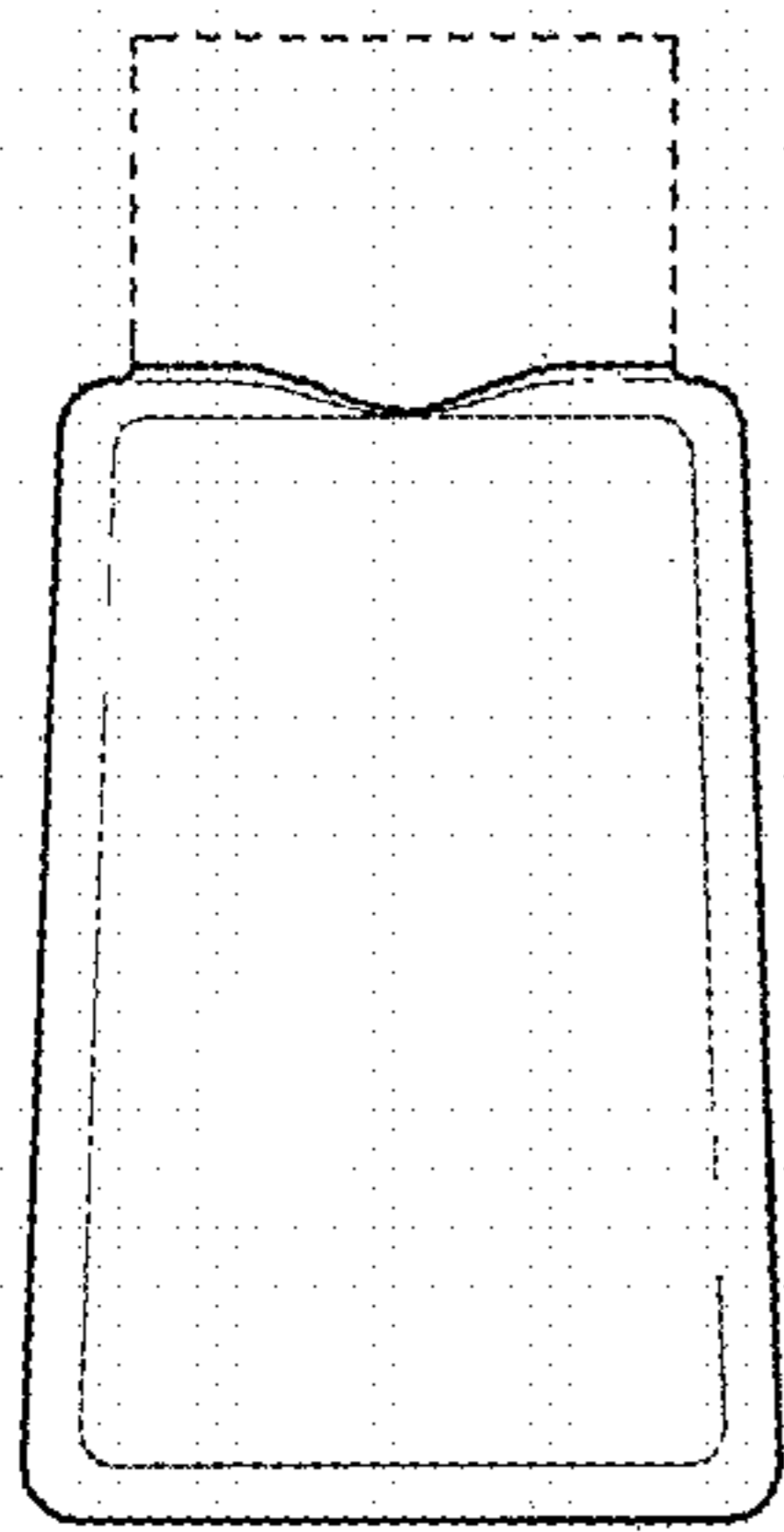

FIG. 13

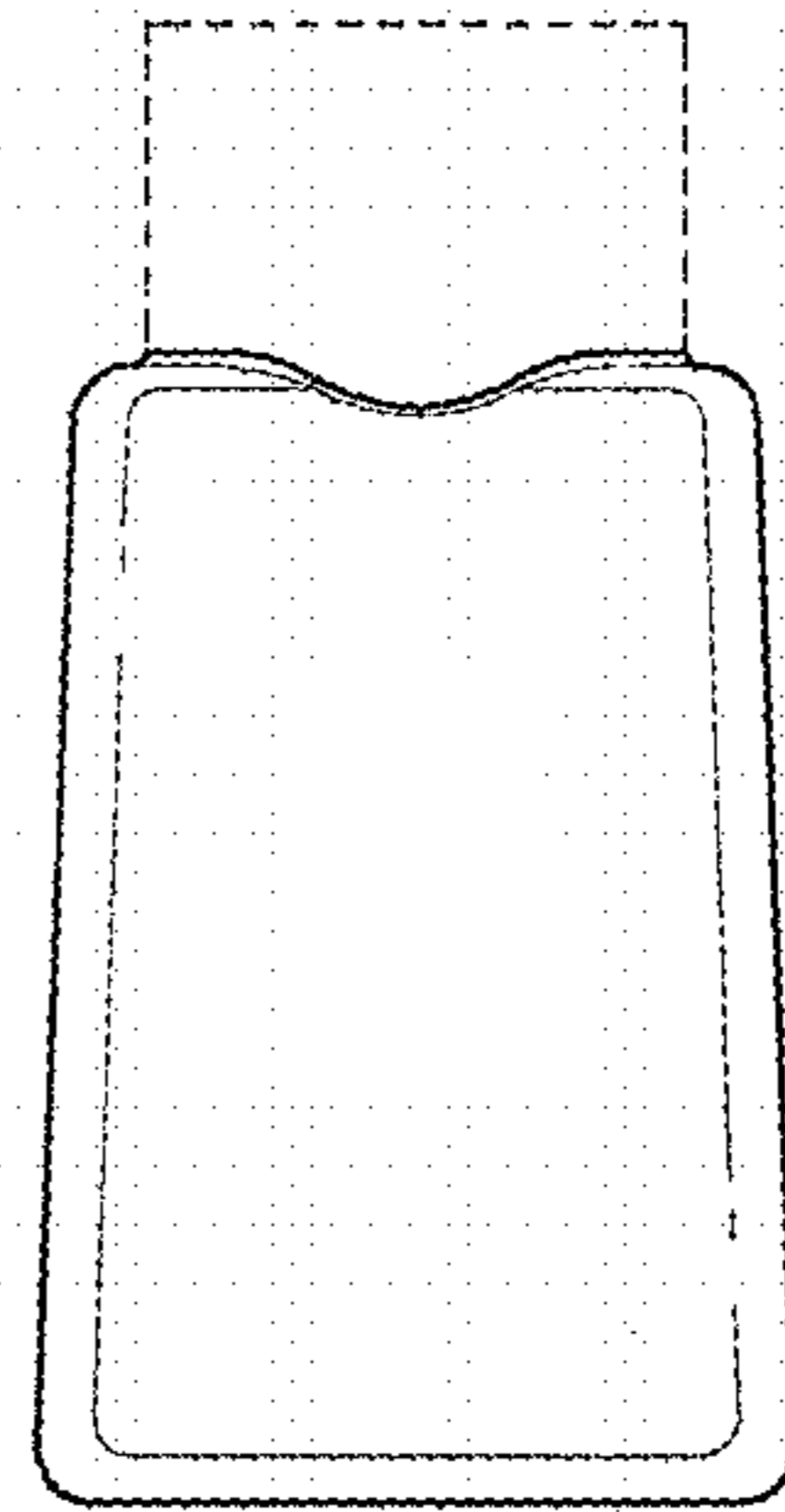

FIG. 14

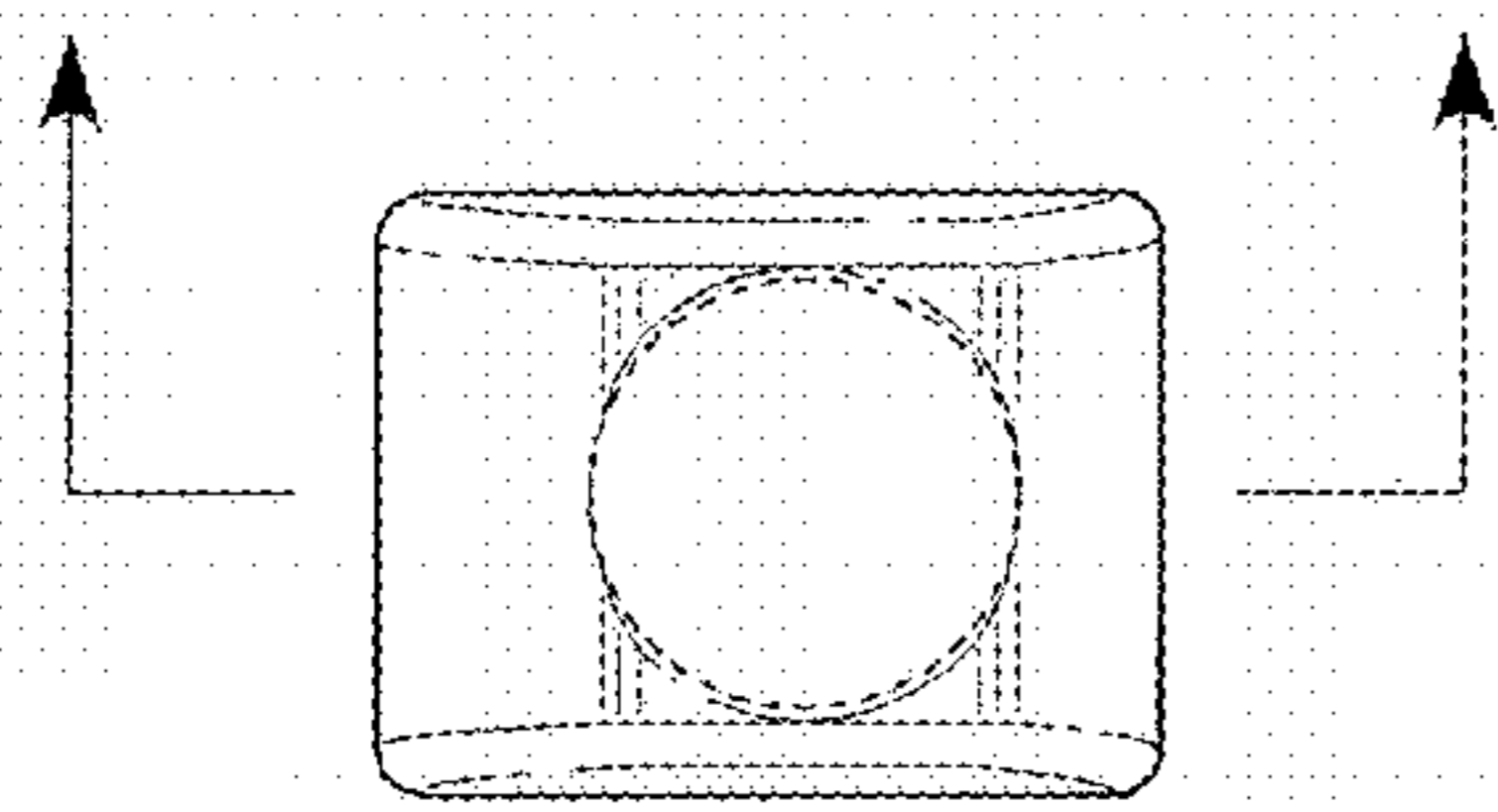

FIG. 15

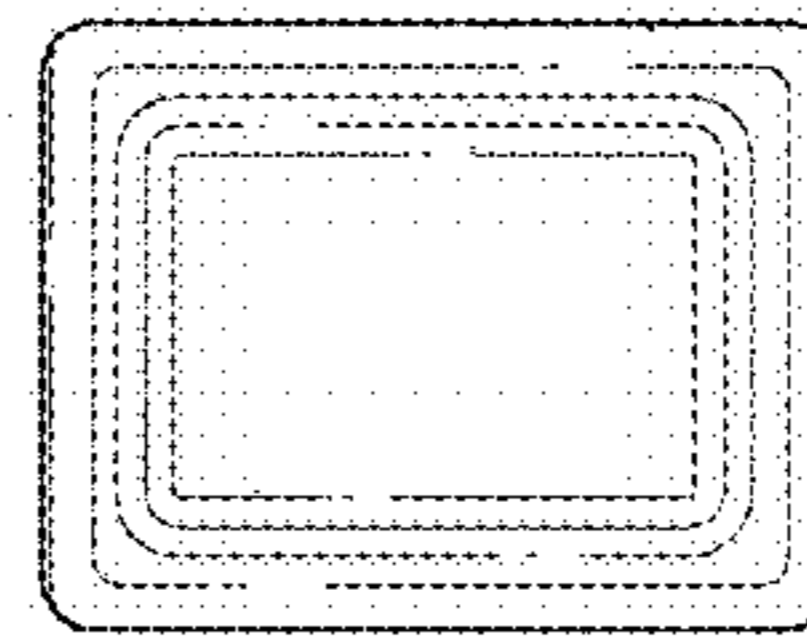

FIG. 16

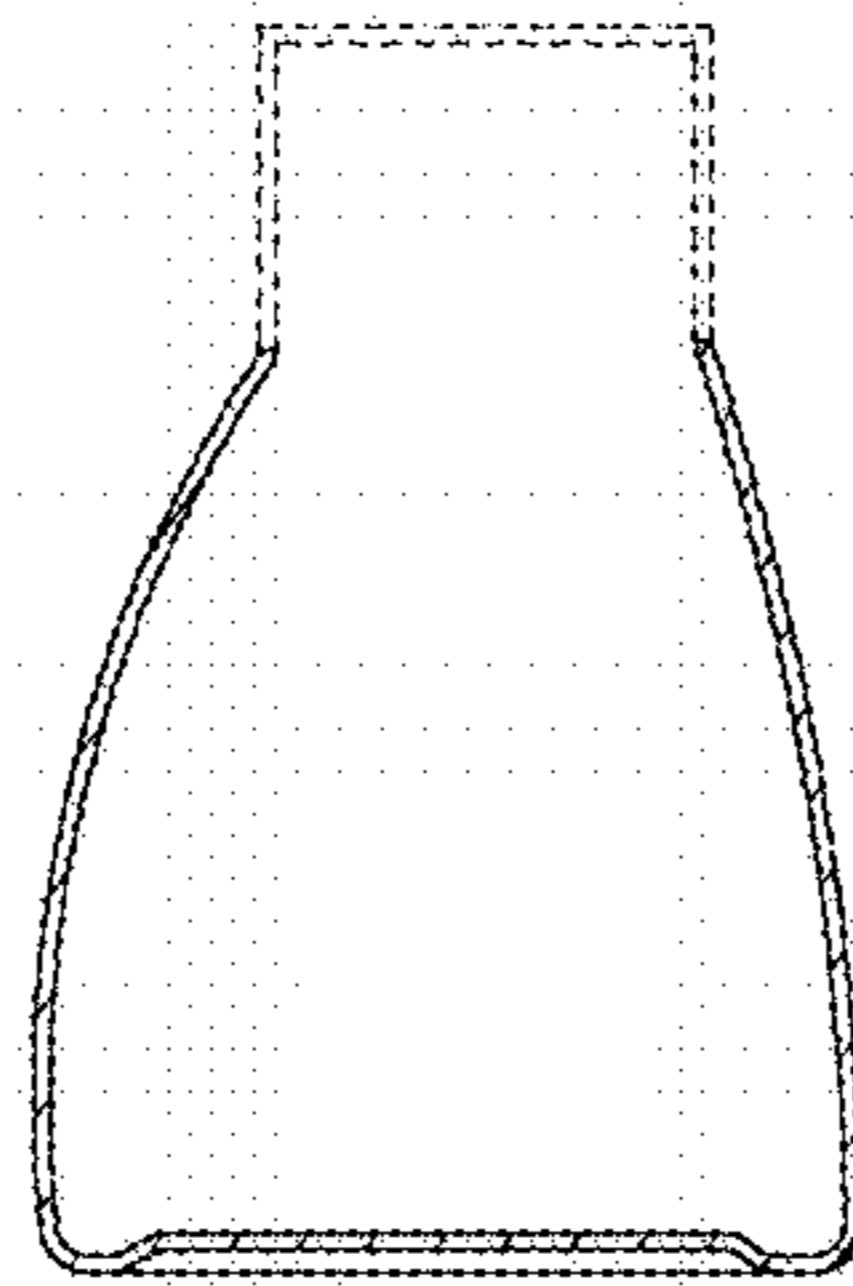

FIG. 17