



US00D802422S

(12) **United States Design Patent**
Laib et al.

(10) **Patent No.:** **US D802,422 S**
(45) **Date of Patent:** **** Nov. 14, 2017**

(54) **CONTAINER**

FOREIGN PATENT DOCUMENTS

(71) Applicant: **Owens-Brockway Glass Container Inc.**, Perrysburg, OH (US)

CN 302975926 * 10/2014
CN 303237594 * 6/2015

(72) Inventors: **Douglas Laib**, Perrysburg, OH (US);
Young Lee, Perrysburg, OH (US)

Primary Examiner — Catherine Tuttle
Assistant Examiner — Mary Malley

(73) Assignee: **Owens-Brockway Glass Container Inc.**, Perrysburg, OH (US)

(57) **CLAIM**

We claim an ornamental design for a container, as shown and described.

(**) Term: **15 Years**

DESCRIPTION

(21) Appl. No.: **29/551,738**

(22) Filed: **Jan. 15, 2016**

(51) **LOC (10) Cl.** **09-01**

(52) **U.S. Cl.**
USPC **D9/500; D9/549**

(58) **Field of Classification Search**
USPC D9/500–505, 516, 529, 530, 537, 538,
D9/541, 549–559, 569, 570, 774, 776,
D9/692, 694, 723–728, 745, 746;
D28/76–91.1

CPC A45D 33/00; A45D 33/003; A45D 33/006;
A45D 33/02; A45D 33/025; A45D 33/18;
A45D 33/22; A45D 34/00; A45D
2034/007; A45D 34/02; A45D 40/40;
A45D 40/0068; A45D 40/0075; A45D
2040/12; A45D 2200/05; A45D 2200/051;
A45D 2200/052; A45D 2200/053; B65D
1/0246

See application file for complete search history.

(56) **References Cited**

U.S. PATENT DOCUMENTS

D266,485 S 10/1982 Guerette
D272,508 S 2/1984 Conti

(Continued)

FIG. 1 is a perspective view of a container in accordance with an illustrative embodiment of our new claimed design. FIG. 2 is a front side view of the container in FIG. 1. FIG. 3 is a right side view of the container in FIG. 1. FIG. 4 is a rear side view of the container in FIG. 1. FIG. 5 is a left side view of the container in FIG. 1. FIG. 6 is a top view of the container in FIG. 1. FIG. 7 is a bottom view of the container in FIG. 1. FIG. 8 is a perspective view of a container in accordance with another illustrative embodiment of our new claimed design.

FIG. 9 is a front side view of the container in FIG. 8. FIG. 10 is a right side view of the container in FIG. 8. FIG. 11 is a rear side view of the container in FIG. 8. FIG. 12 is a left side view of the container in FIG. 8. FIG. 13 is a top view of the container in FIG. 8; and, FIG. 14 is a bottom view of the container in FIG. 8.

The terms top, left, right, bottom, rear, side, and front are used for reference only and do not limit the claimed design. The dash-dash-dash broken lines show the portions of the container that are not part of the claimed design.

Dash-dot-dash broken lines shown in the drawings represent boundaries of the claimed design and are not part of the claimed design.

Shading lines shown in the drawings represent surface character and/or contour, and such lines are not part of the claimed design.

Portions of the container not shown in the drawings form no part of the claimed design.

1 Claim, 4 Drawing Sheets

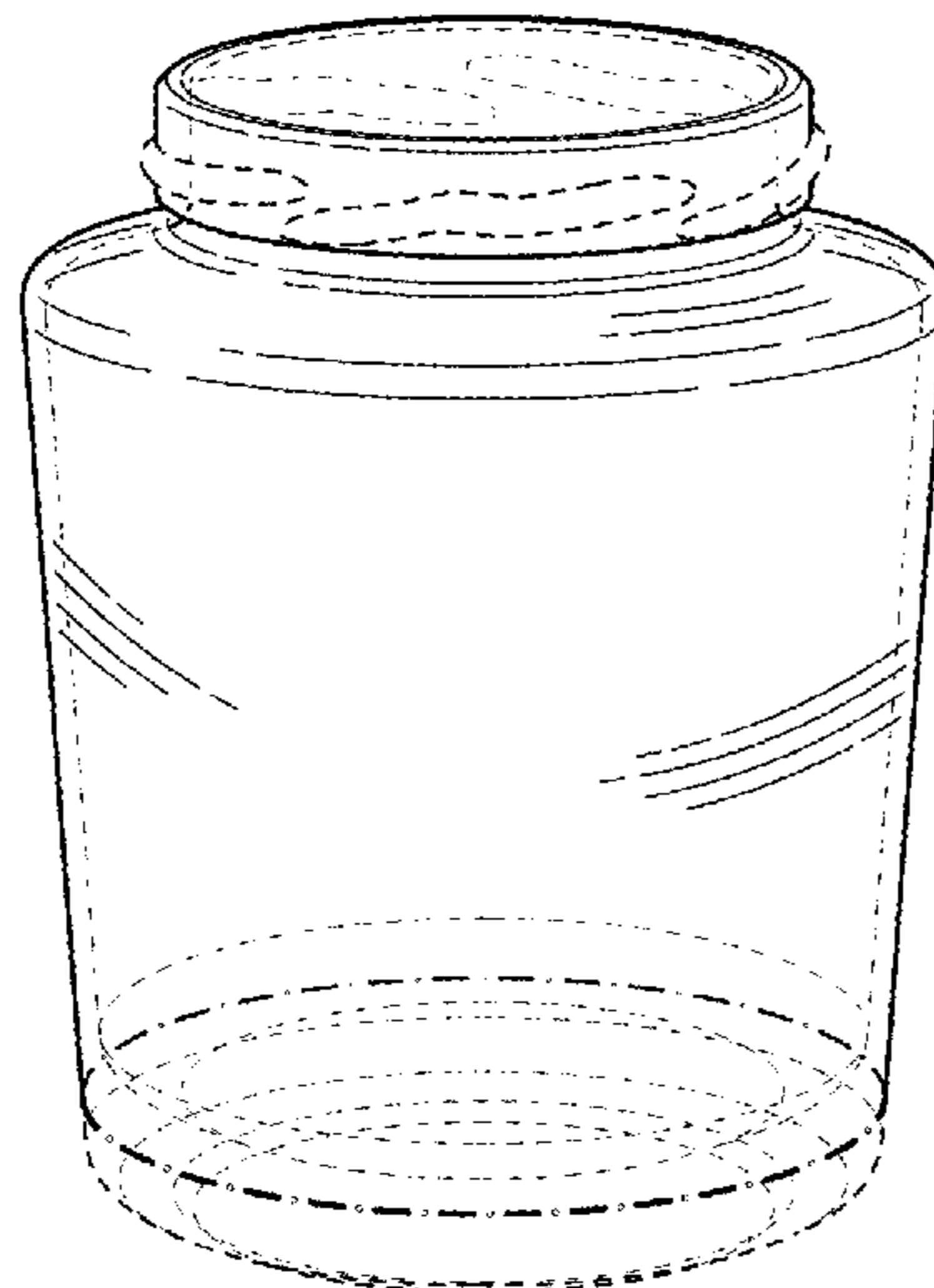

(56)

References Cited

U.S. PATENT DOCUMENTS

D279,651 S 7/1985 Freeman
 D283,594 S 4/1986 MacLaughlin et al.
 D283,595 S 4/1986 Fortuna et al.
 D283,677 S 5/1986 Fortuna et al.
 4,665,682 A * 5/1987 Kerins B29C 49/0005
 264/37.31
 D321,477 S 11/1991 Gunter
 5,269,437 A * 12/1993 Gyfax B65D 1/0276
 215/373
 D355,605 S 2/1995 Kudo et al.
 D412,440 S 8/1999 Chuang
 D419,452 S * 1/2000 DeVore D9/500
 D435,449 S 12/2000 Moretti
 D443,821 S * 6/2001 Bakic D9/500
 D474,978 S * 5/2003 Varlet D9/549
 D495,608 S * 9/2004 Klemm D9/552
 D536,976 S 2/2007 Ciulla et al.
 D554,519 S * 11/2007 Varlet D9/549
 D592,510 S 5/2009 Dell'Orto
 D596,505 S 7/2009 Diss et al.
 D596,958 S 7/2009 Diss et al.
 D606,402 S 12/2009 Diss
 D606,403 S 12/2009 Diss
 D607,329 S 1/2010 Diss

D607,330 S 1/2010 Diss
 D610,875 S 3/2010 WingField et al.
 D616,749 S 6/2010 Tivelli et al.
 D619,013 S * 7/2010 Potts D9/500
 D626,414 S 11/2010 Cresswell et al.
 D633,794 S 3/2011 Cresswell et al.
 D633,795 S 3/2011 Cresswell et al.
 D633,796 S 3/2011 Cresswell et al.
 D638,709 S 5/2011 Yourist
 D645,746 S * 9/2011 Yu D9/445
 D657,245 S * 4/2012 Delbon D9/500
 D659,004 S 5/2012 McCoy
 D672,655 S * 12/2012 Huffman D9/500
 D677,569 S 3/2013 Lemaitre
 D694,112 S 11/2013 Brown
 D700,517 S * 3/2014 Oommen D9/500
 D703,057 S 4/2014 Moore et al.
 D713,258 S * 9/2014 Del Bon D9/545
 D722,273 S 2/2015 Ivie
 D730,189 S * 5/2015 Haile D4/116
 D734,155 S 7/2015 Moore et al.
 D734,671 S * 7/2015 Herbst D9/538
 D756,716 S * 5/2016 Hewitt D7/608
 D765,509 S * 9/2016 Laib D9/500
 D765,510 S * 9/2016 Laib D9/500
 2012/0152882 A1 * 6/2012 Tune B65D 1/0223
 215/40

* cited by examiner

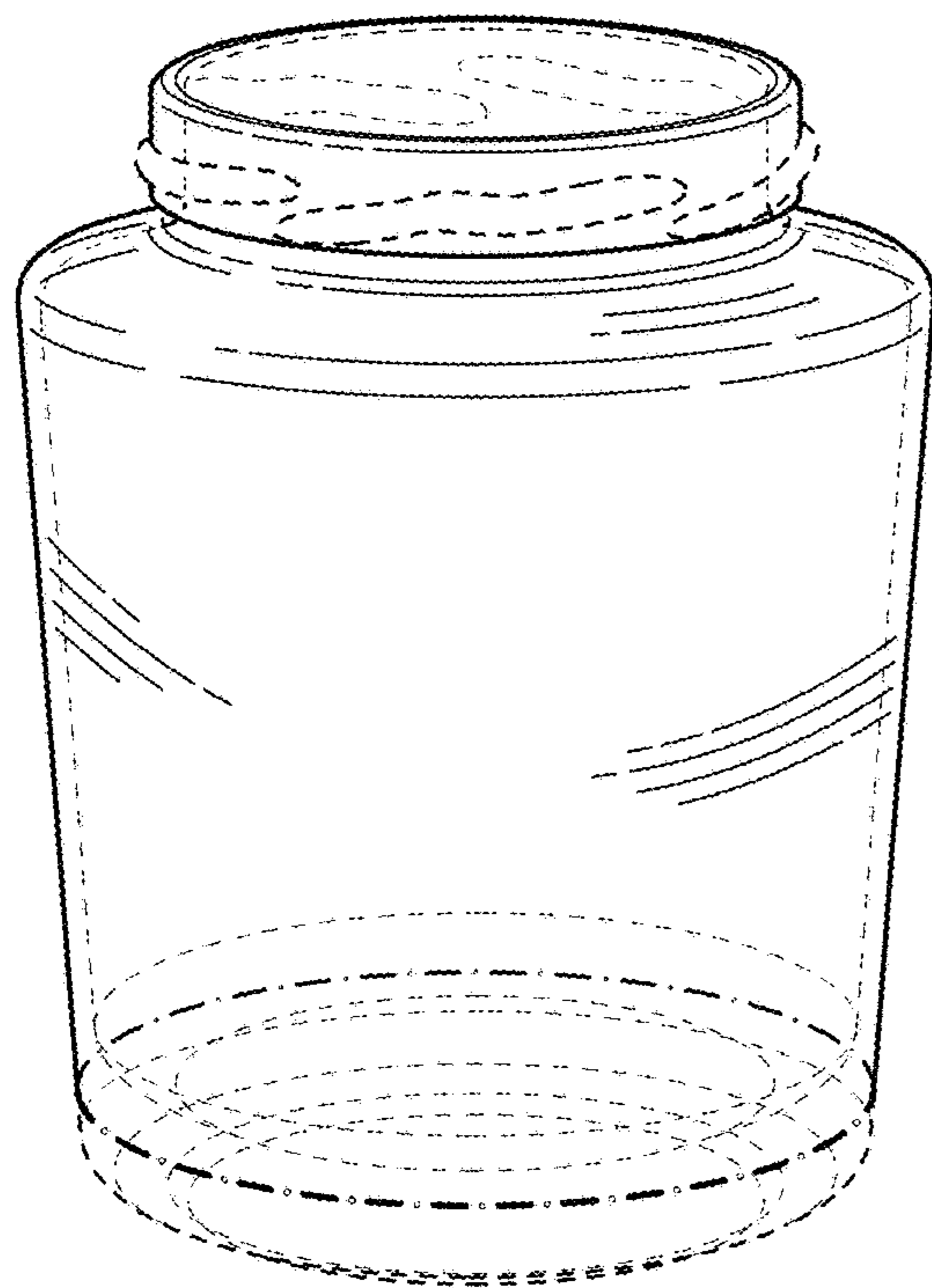

FIG. 1

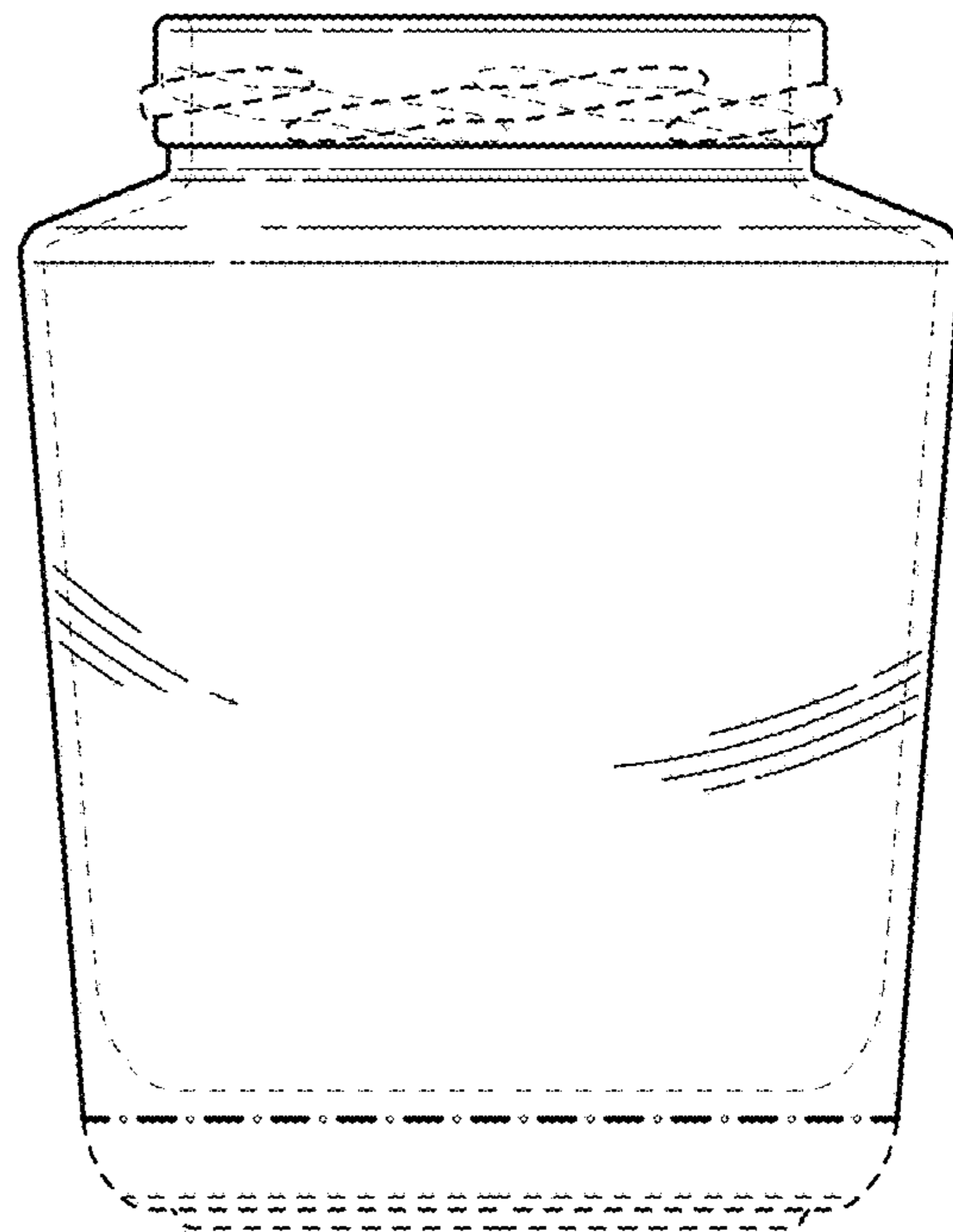

FIG. 2

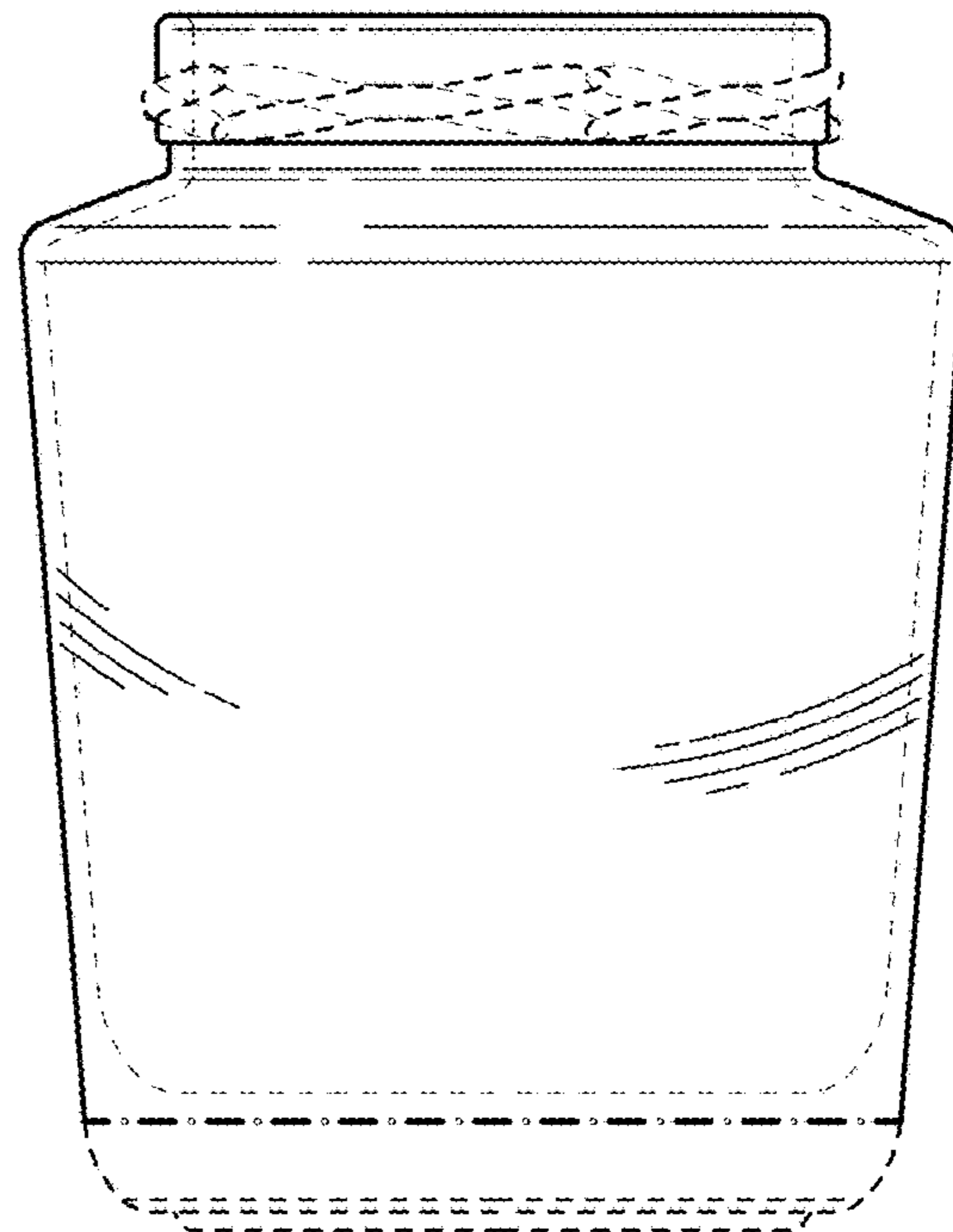

FIG. 3

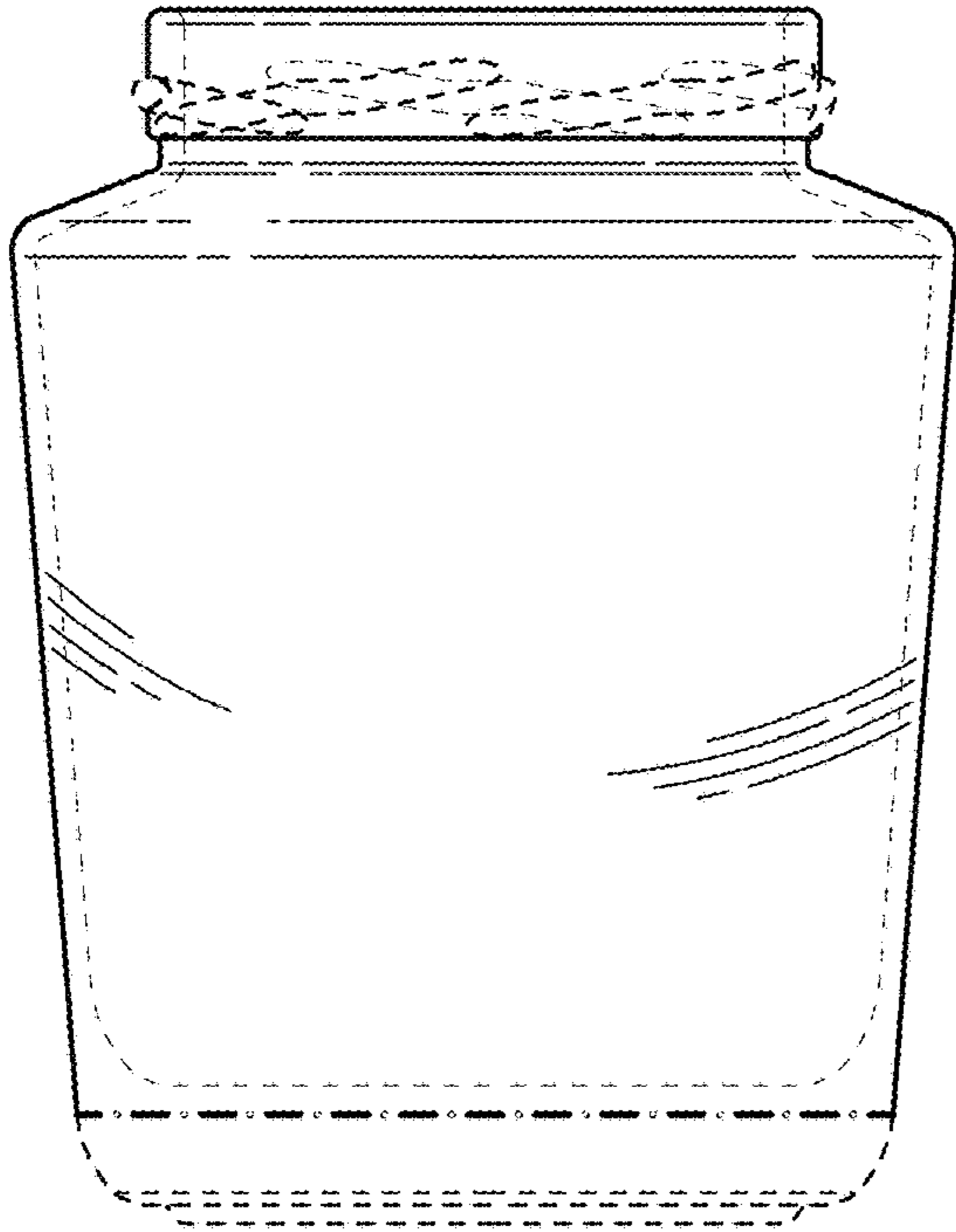

FIG. 4

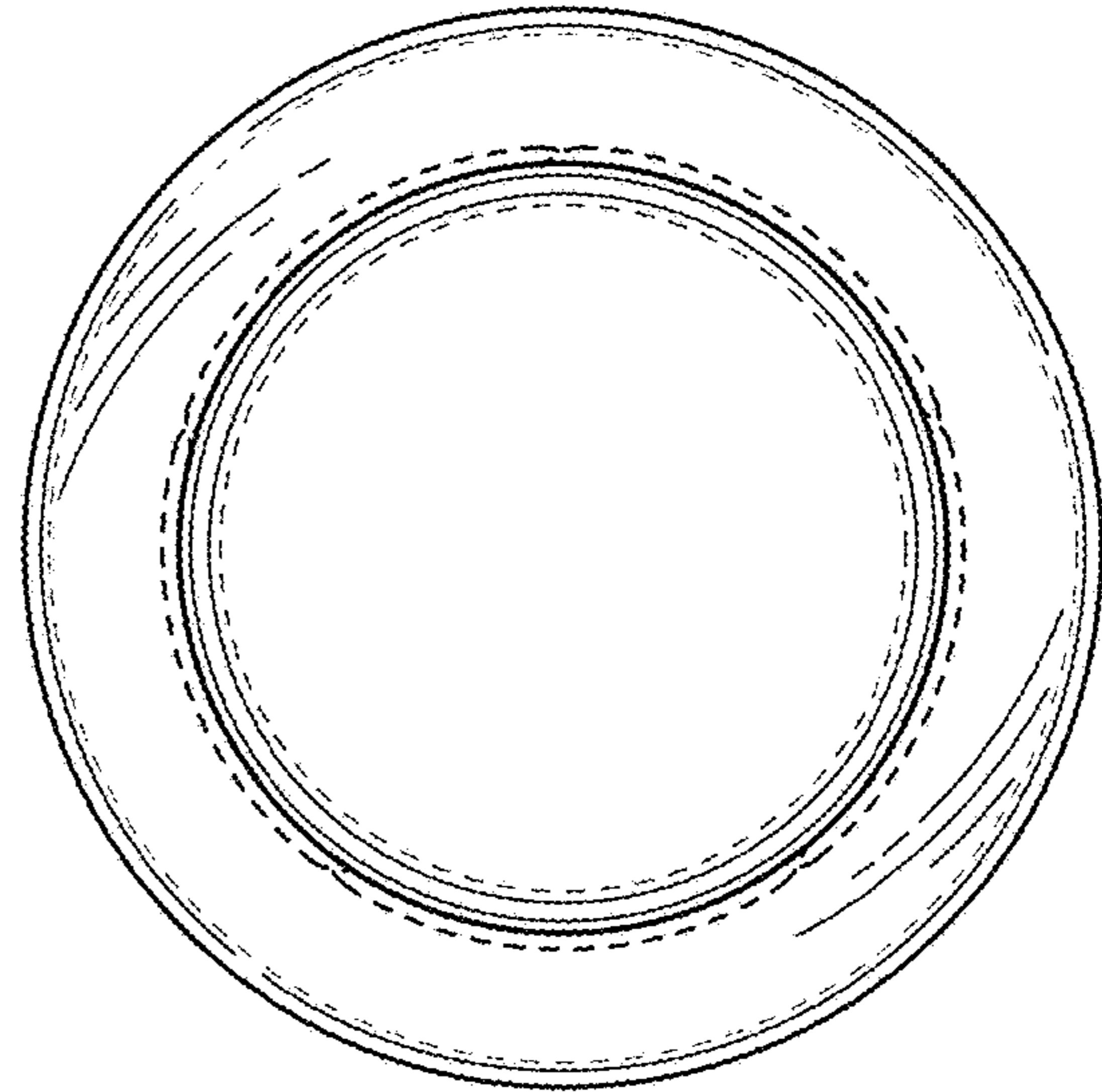

FIG. 6

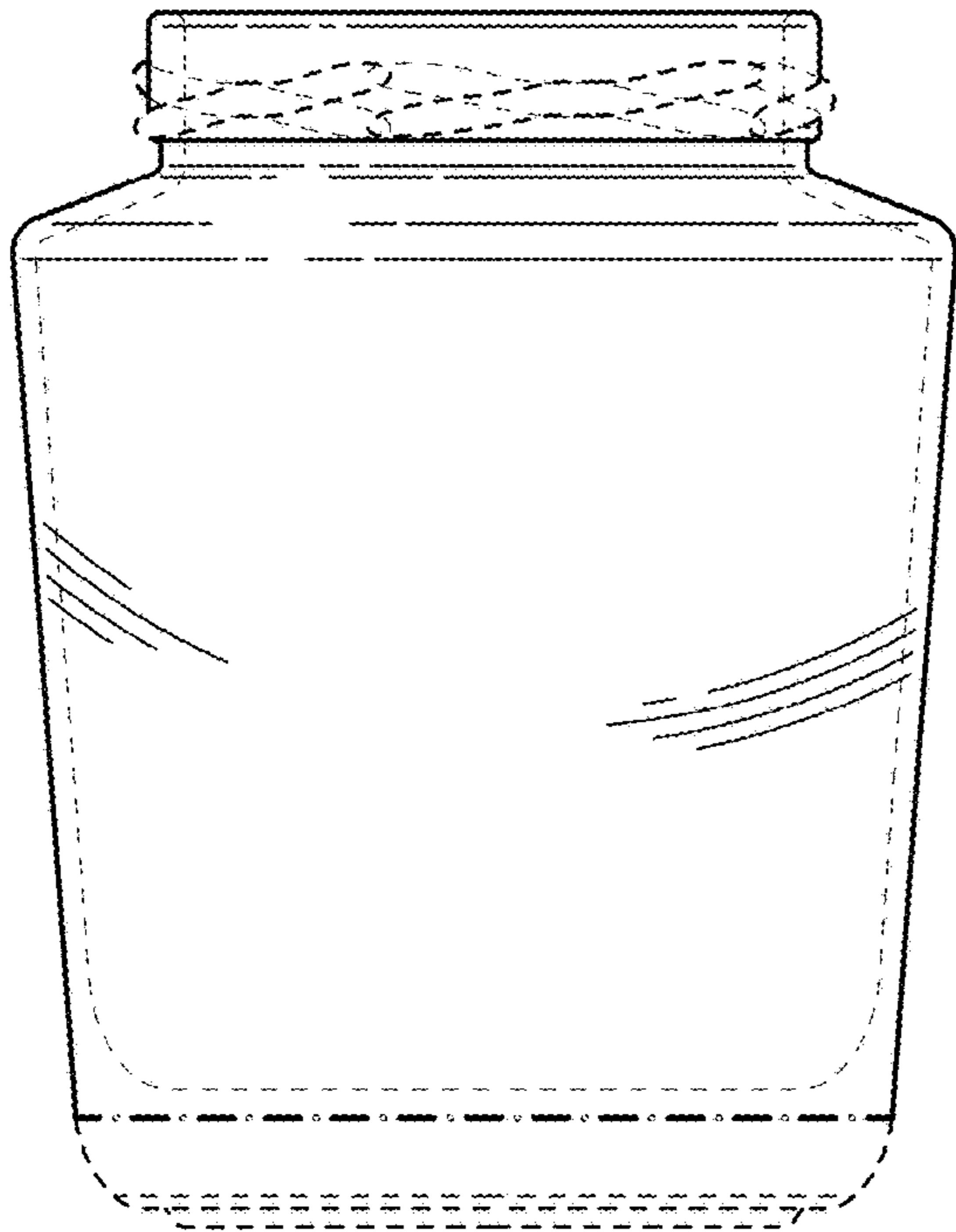

FIG. 5

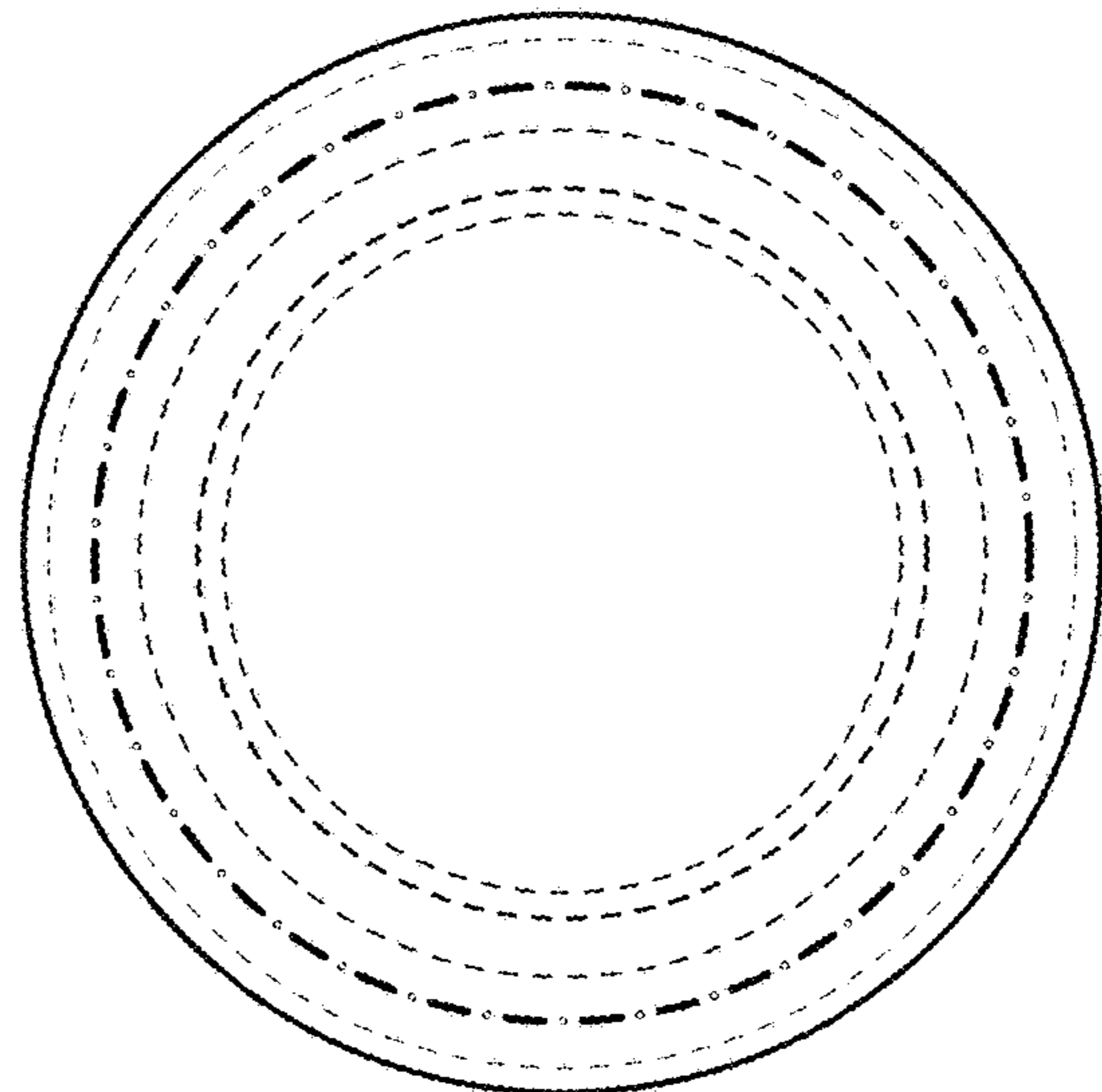

FIG. 7

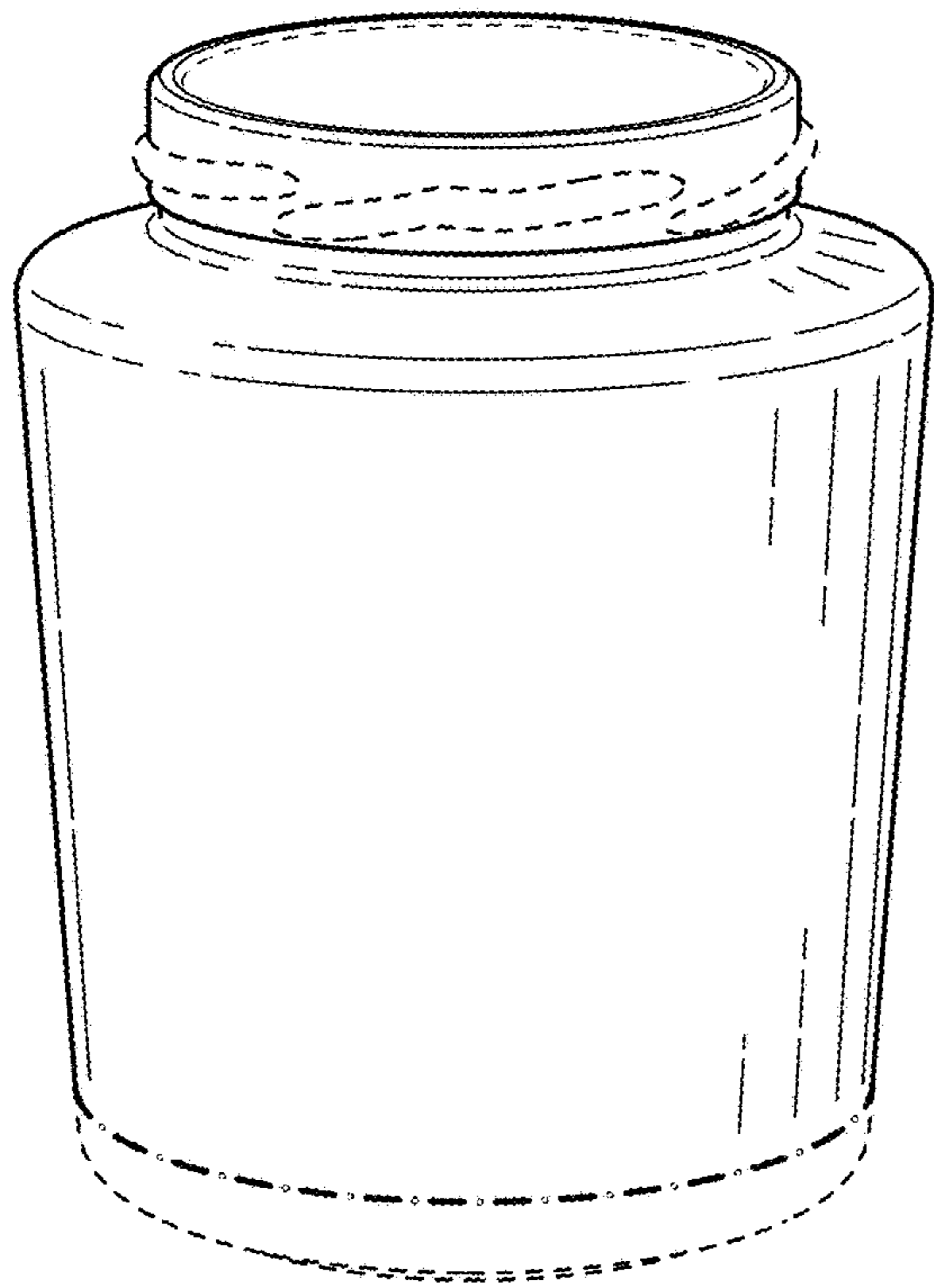

FIG. 8

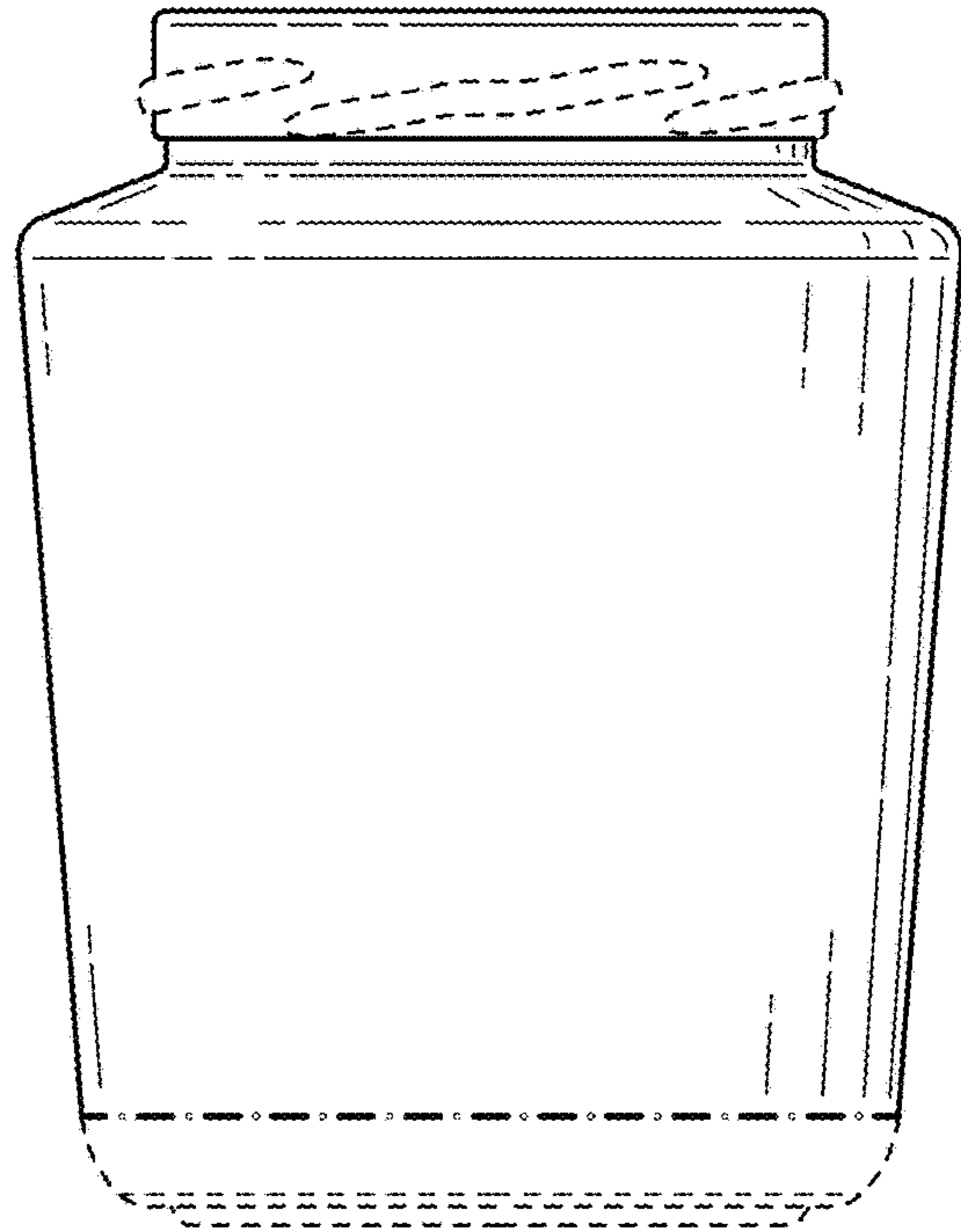

FIG. 9

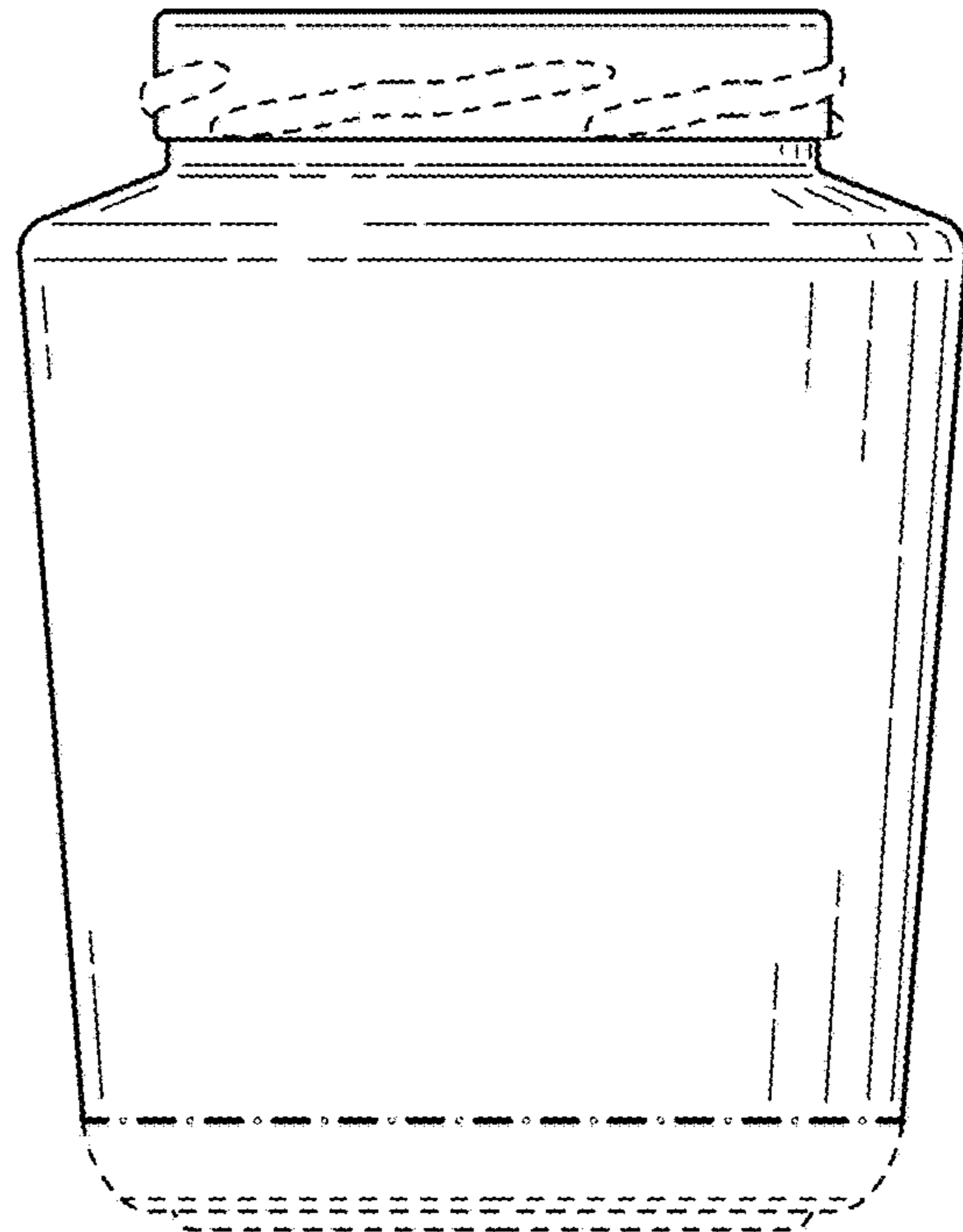

FIG. 10

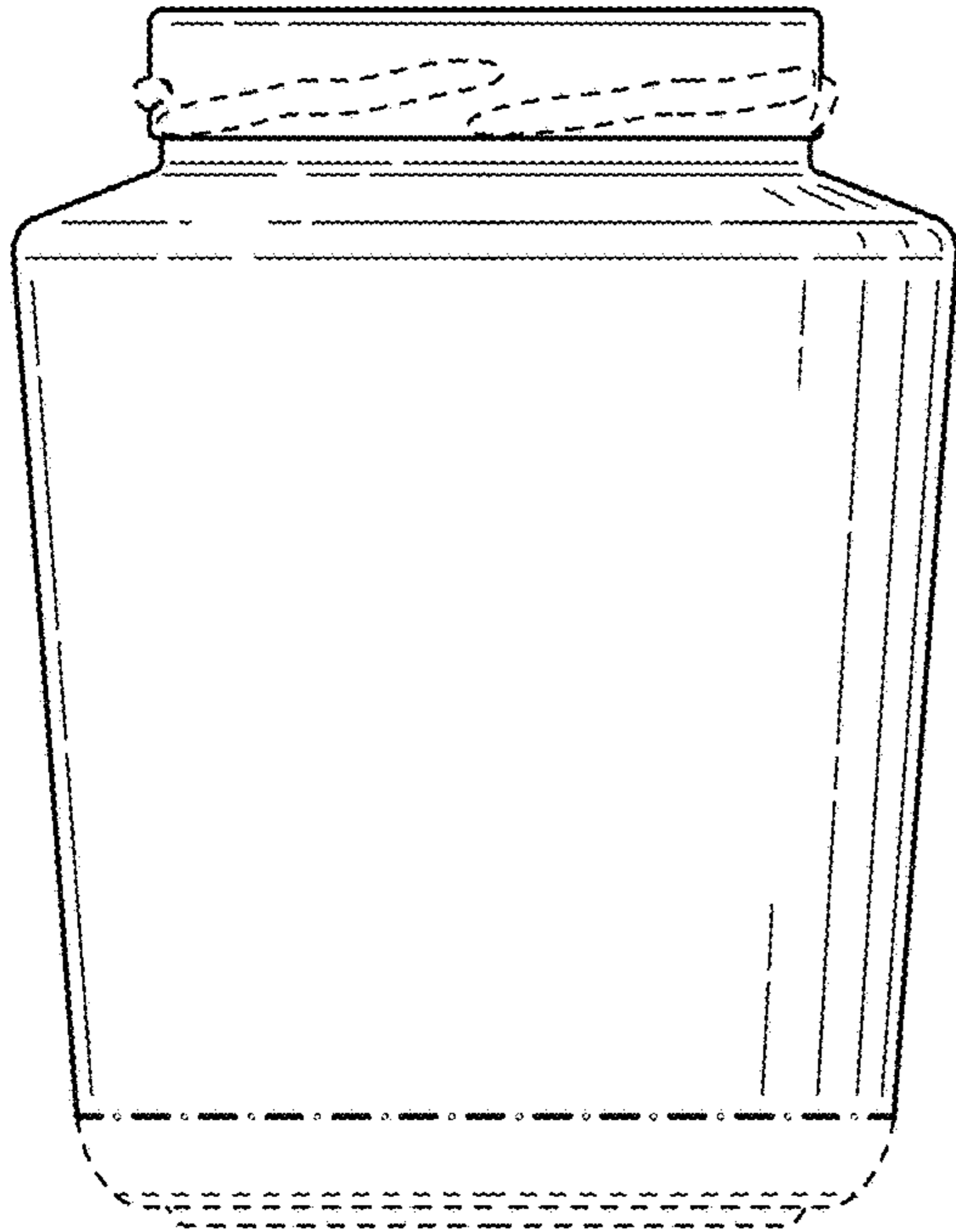

FIG. 11

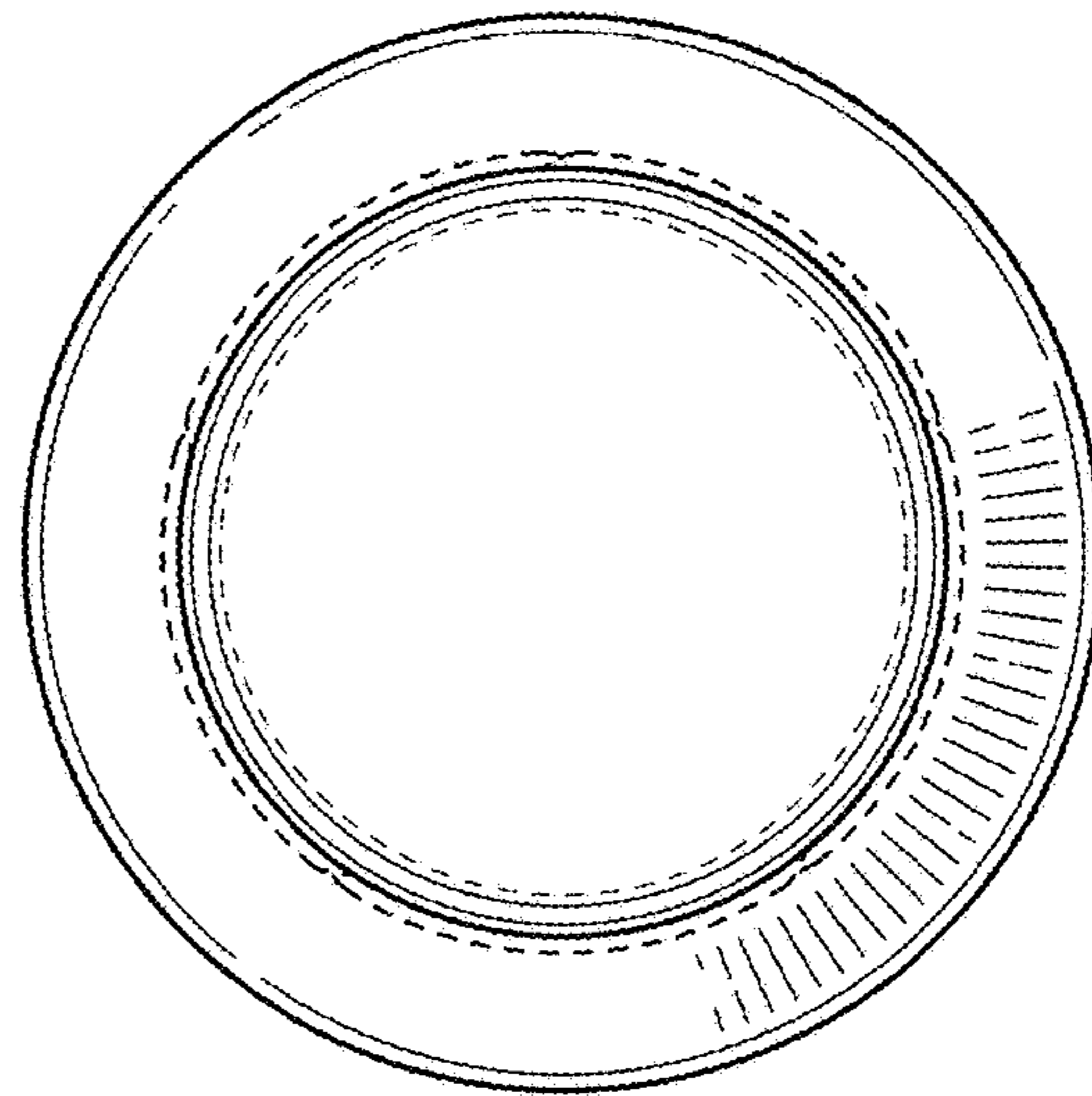

FIG. 13

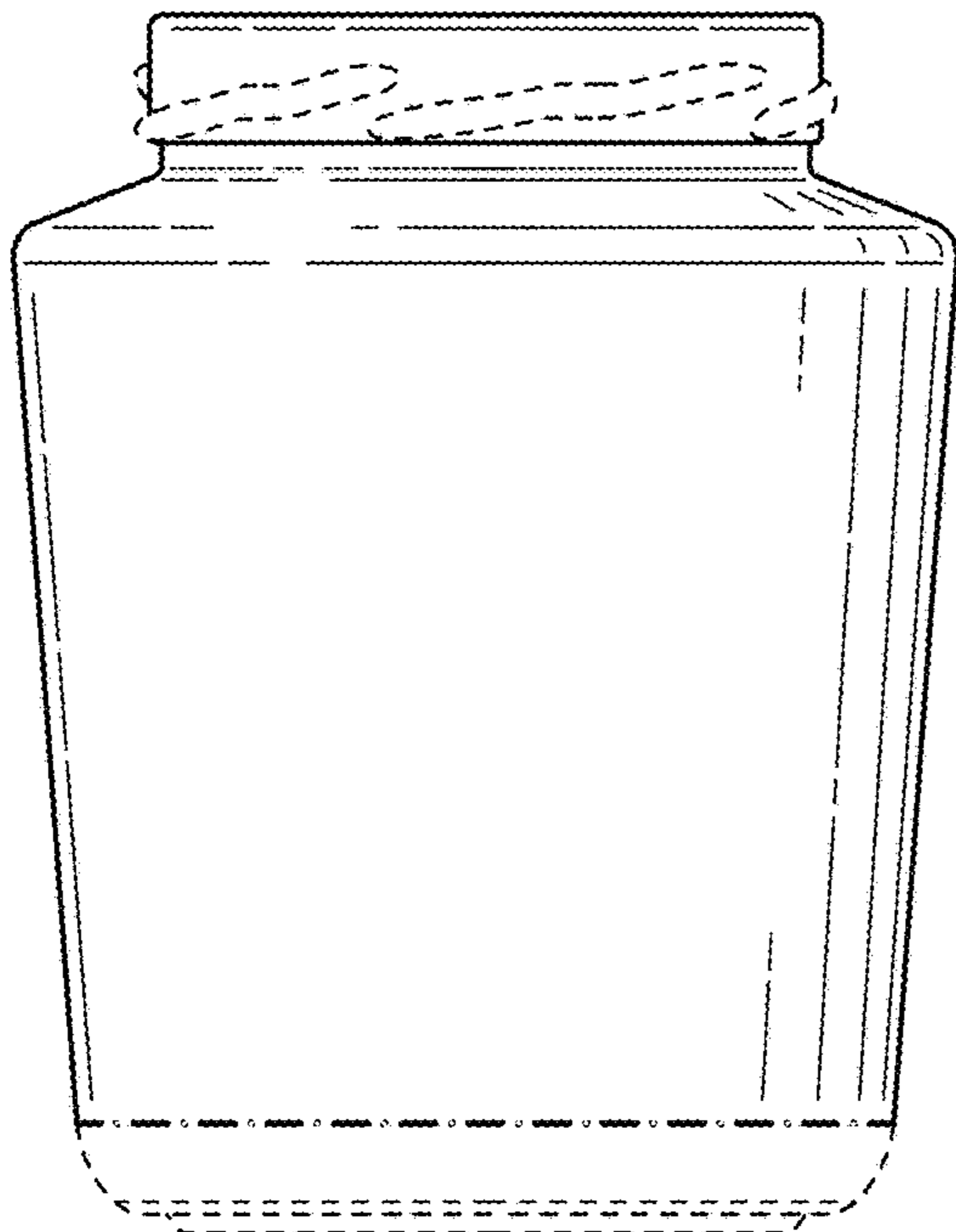

FIG. 12

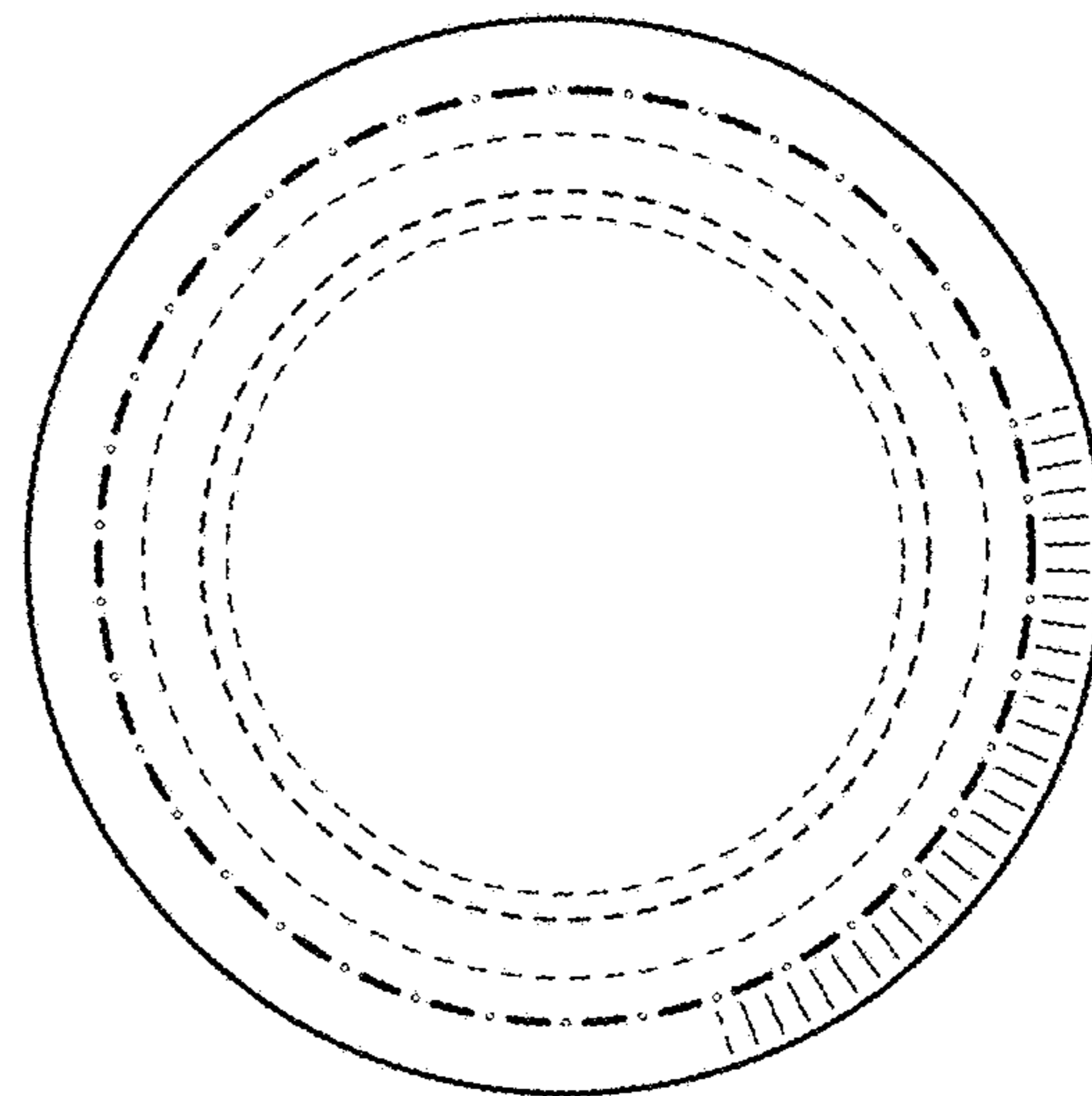

FIG. 14