



US00D802414S

(12) **United States Design Patent** (10) **Patent No.:** **US D802,414 S**
Delle Cese et al. (45) **Date of Patent:** **** Nov. 14, 2017**

(54) **PACKAGE**

(71) Applicant: **Apple Inc.**, Cupertino, CA (US)

(72) Inventors: **Francesca Amor Delle Cese**, San Francisco, CA (US); **Lorraine Y. Tang**, San Francisco, CA (US); **Bhautik H. Mehta**, Mountain View, CA (US); **Mark T. Uyeda**, Campbell, CA (US); **Alissa Anderson**, San Francisco, CA (US); **Jonathan Berk**, Mountain View, CA (US); **Margaret Madigan Burke**, Sunnyvale, CA (US); **Jack Wanderman**, San Francisco, CA (US); **Kevin Scott Fetterman**, Los Altos, CA (US)

(73) Assignee: **Apple Inc.**, Cupertino, CA (US)

(**) Term: **15 Years**

(21) Appl. No.: **29/587,651**

(22) Filed: **Dec. 14, 2016**

Related U.S. Application Data

(63) Continuation of application No. 29/519,821, filed on Mar. 9, 2015, now Pat. No. Des. 779,932, and a (Continued)

(51) **LOC (10) Cl.** **09-03**

(52) **U.S. Cl.**
USPC **D9/419**

(58) **Field of Classification Search**
USPC D9/414-419, 499, 431-434, 721, 456, D9/443, 438, 737, 722; D7/505, 392, (Continued)

(56) **References Cited**

U.S. PATENT DOCUMENTS

1,514,379 A * 11/1924 Fleischer 126/261
3,381,876 A * 5/1968 Biggins A47G 23/06
206/229

(Continued)

Primary Examiner — Rhea Shields

(74) *Attorney, Agent, or Firm* — Sterne, Kessler, Goldstein & Fox P.L.L.C.

(57) **CLAIM**

The ornamental design for a package, as shown and described.

DESCRIPTION

FIG. 1 is a top front exploded perspective view of a package showing the claimed design;
FIG. 2 is a top front perspective view of the lid of FIG. 1;
FIG. 3 is a front view thereof;
FIG. 4 is a rear view thereof;
FIG. 5 is a left side view thereof;
FIG. 6 is a right side view thereof;
FIG. 7 is a top view thereof;
FIG. 8 is a bottom view thereof;
FIG. 9 is a top front perspective view of the inner packaging, or case, of FIG. 1;
FIG. 10 is a front view thereof;
FIG. 11 is a rear view thereof;
FIG. 12 is a left side view thereof;
FIG. 13 is a right side view thereof;
FIG. 14 is a top view thereof;
FIG. 15 is a bottom view thereof;
FIG. 16 is a top front perspective view of the sleeve of FIG. 1;
FIG. 17 is a front view thereof;
FIG. 18 is a rear view thereof;
FIG. 19 is a left side view thereof;
FIG. 20 is a right side view thereof;
FIG. 21 is a top view thereof;
FIG. 22 is a bottom view thereof;
FIG. 23 is a top front perspective view of the accessory holder insert of FIG. 1;
FIG. 24 is a front view thereof;
FIG. 25 is a rear view thereof;
FIG. 26 is a left side view thereof;
FIG. 27 is a right side view thereof;
FIG. 28 is a top view thereof;
FIG. 29 is a bottom view thereof;
FIG. 30 is a top front perspective view of the base of FIG. 1;

(Continued)

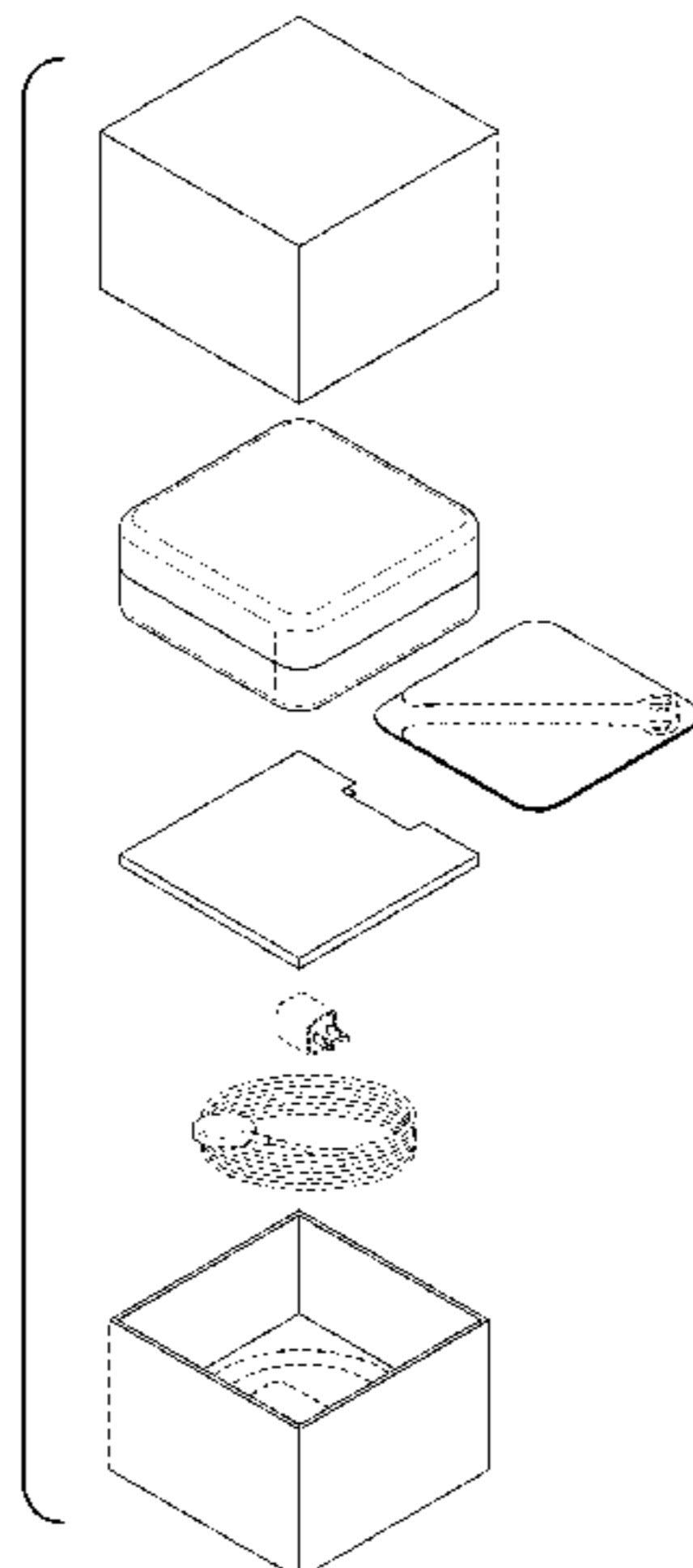

FIG. 31 is a front view thereof;
 FIG. 32 is a rear view thereof;
 FIG. 33 is a left side view thereof;
 FIG. 34 is a right side view thereof;
 FIG. 35 is a top view thereof; and
 FIG. 36 is a bottom view thereof.
 The broken lines in the figures show portions of the package that form no part of the claimed design.

1 Claim, 19 Drawing Sheets

Related U.S. Application Data

continuation of application No. 29/519,936, filed on Mar. 9, 2015, now Pat. No. Des. 774,899.

(58) **Field of Classification Search**

USPC D7/392.1; D3/313; D11/131.1;
 D14/480.3; D1/106; D30/101; D26/85;
 D6/300; 206/349, 320
 CPC B65D 5/6664; B25H 3/006
 See application file for complete search history.

(56) **References Cited**

U.S. PATENT DOCUMENTS

3,679,093 A * 7/1972 Chang A47G 19/03
 206/542

D308,941 S * 7/1990 Kong D7/505
 D356,499 S * 3/1995 Cautereels D9/434
 5,441,152 A * 8/1995 Estes B25H 3/006
 206/349
 D368,221 S * 3/1996 Montague D9/722
 D372,582 S * 8/1996 Beaty D3/313
 D398,524 S * 9/1998 Waterhouse D9/737
 6,305,539 B1 * 10/2001 Sanders, Jr. B65D 5/6664
 206/320
 D527,674 S * 9/2006 Biglarians D11/131.1
 D564,830 S * 3/2008 Holmes D7/392
 D605,469 S * 12/2009 Wingfield D7/505
 D647,532 S * 10/2011 Busch D14/480.3
 D661,186 S * 6/2012 Snyder 435/447
 D679,181 S * 4/2013 Vogel D9/443
 D688,027 S * 8/2013 Smith D1/106
 D698,199 S * 1/2014 Yessin D7/392.1
 D704,987 S * 5/2014 Stamper D7/392.1
 D714,143 S * 9/2014 Hodge D9/438
 D734,898 S * 7/2015 Lutz D30/101
 D735,577 S * 8/2015 Lee D9/436
 D738,027 S * 9/2015 Wang D26/85
 D740,117 S * 10/2015 Nichols D9/456
 D741,069 S * 10/2015 Vanderheyden D6/300
 D744,855 S * 12/2015 Akana D9/432
 D746,599 S * 1/2016 Olson D6/300
 D764,910 S 8/2016 Akana et al.
 D773,927 S 12/2016 Cernokus et al.

* cited by examiner

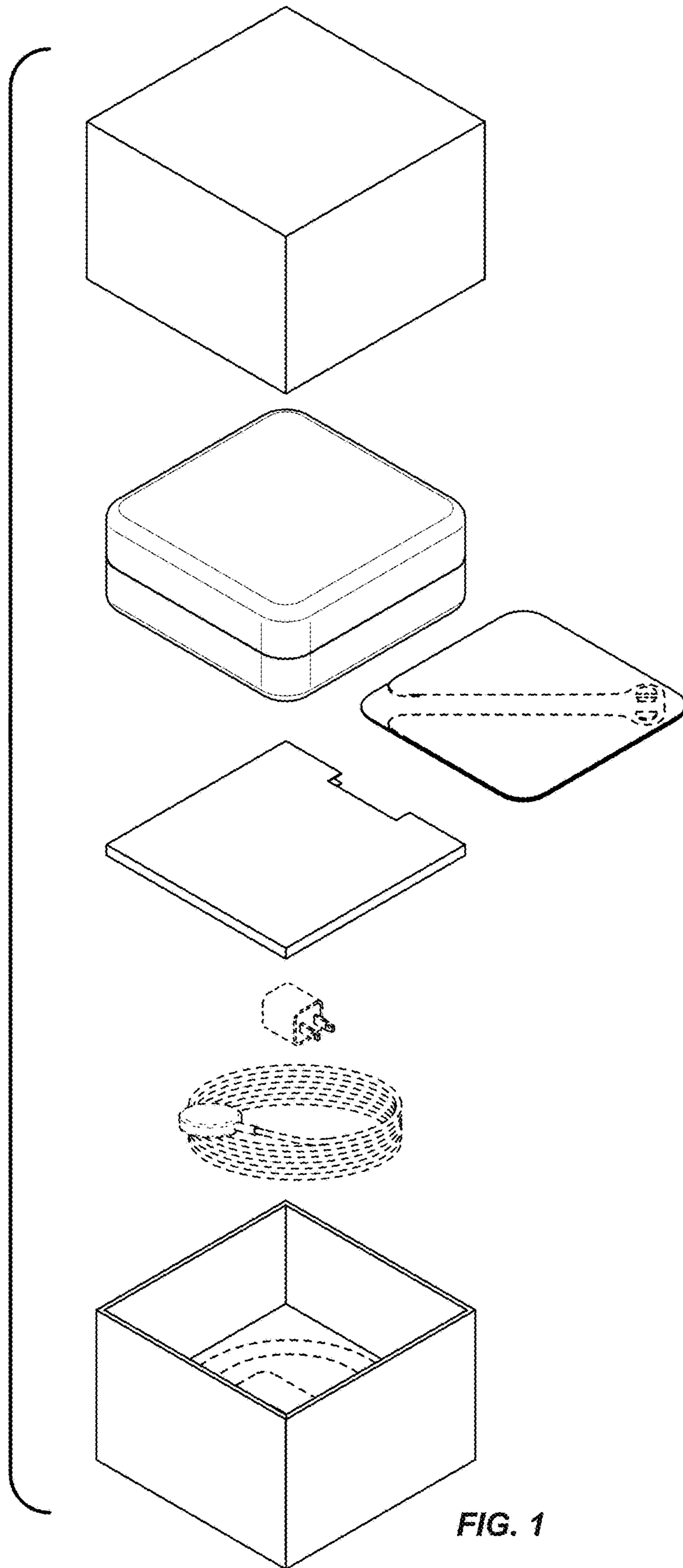

FIG. 1

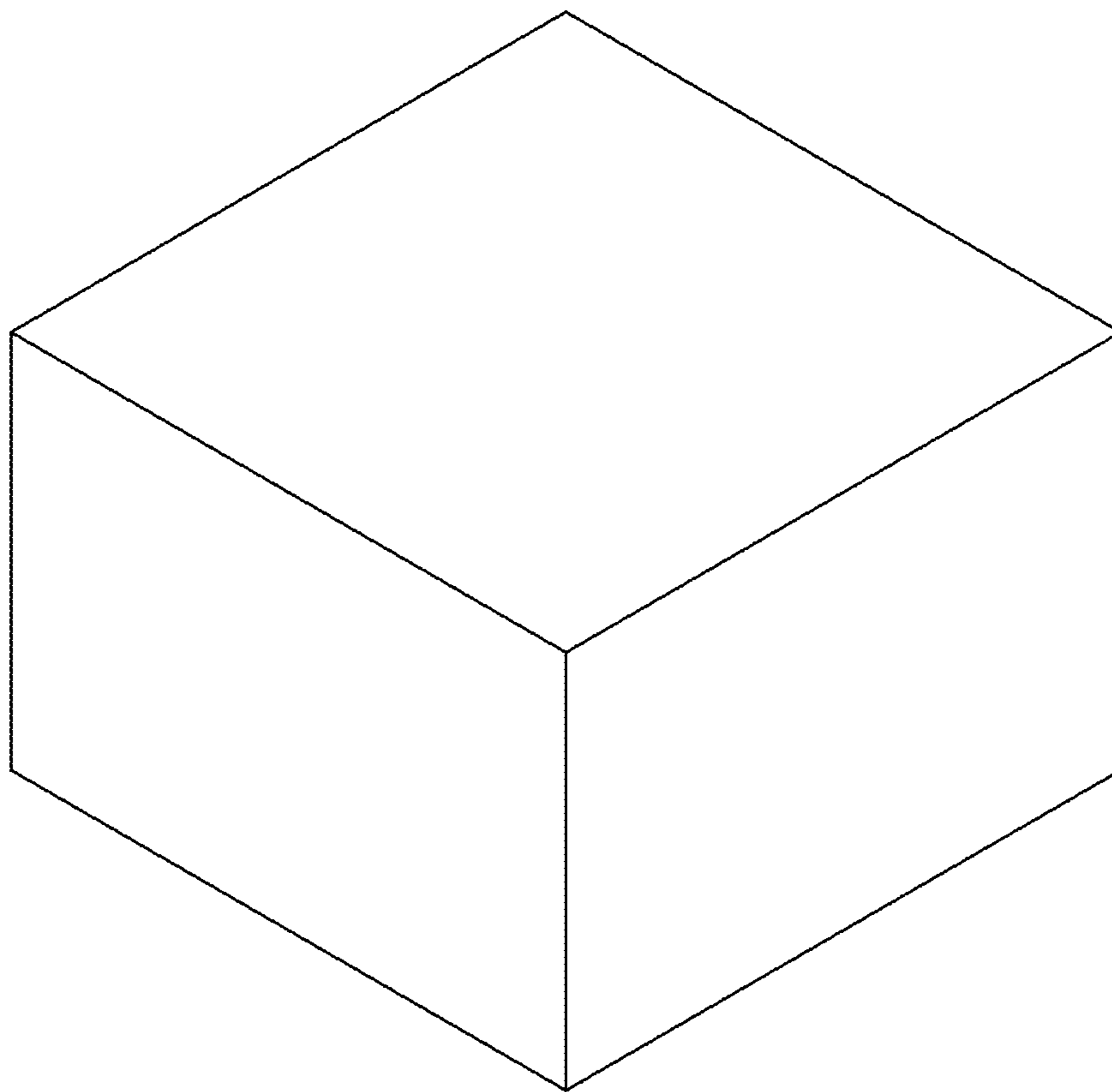

FIG. 2

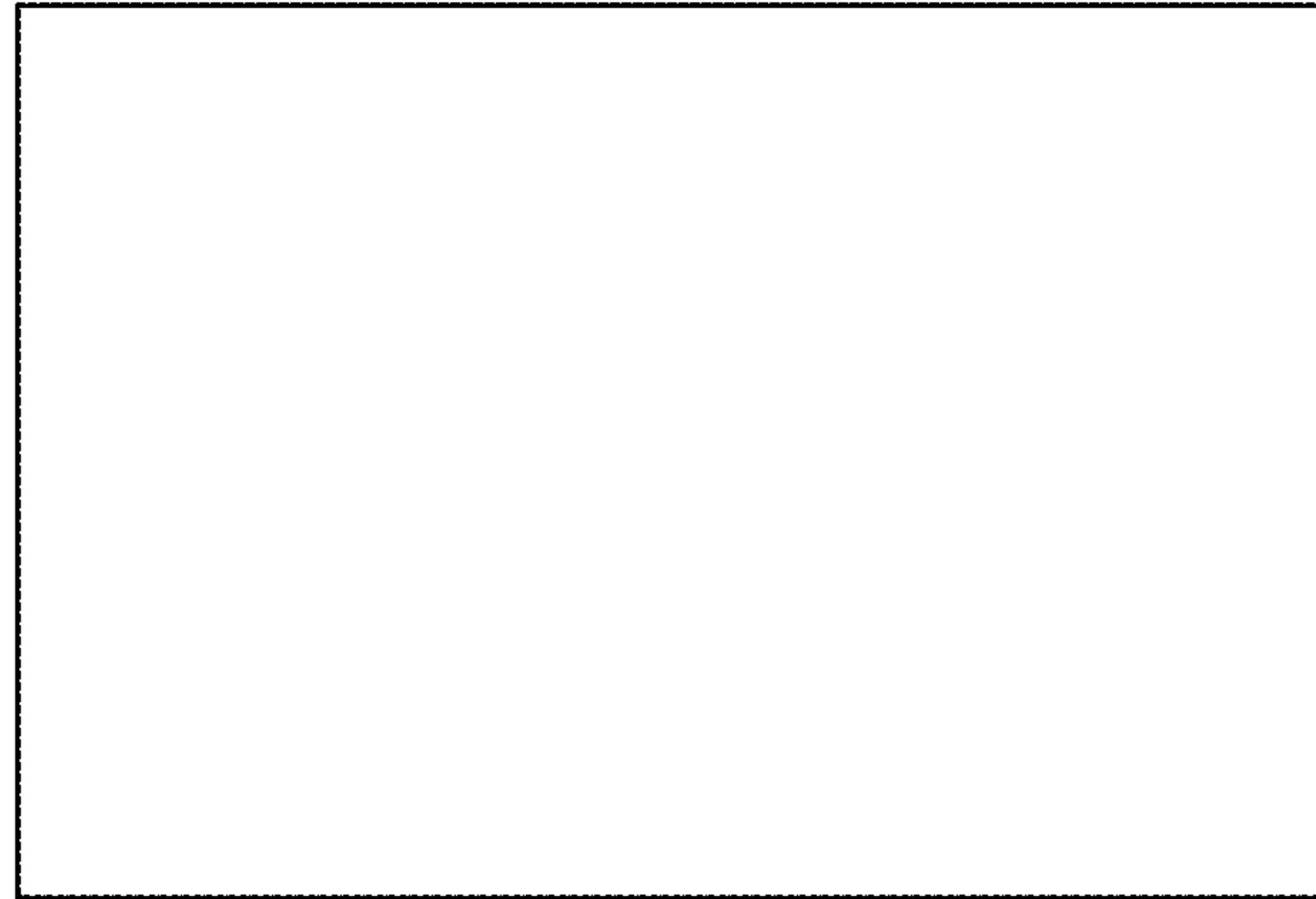

FIG. 3



FIG. 4

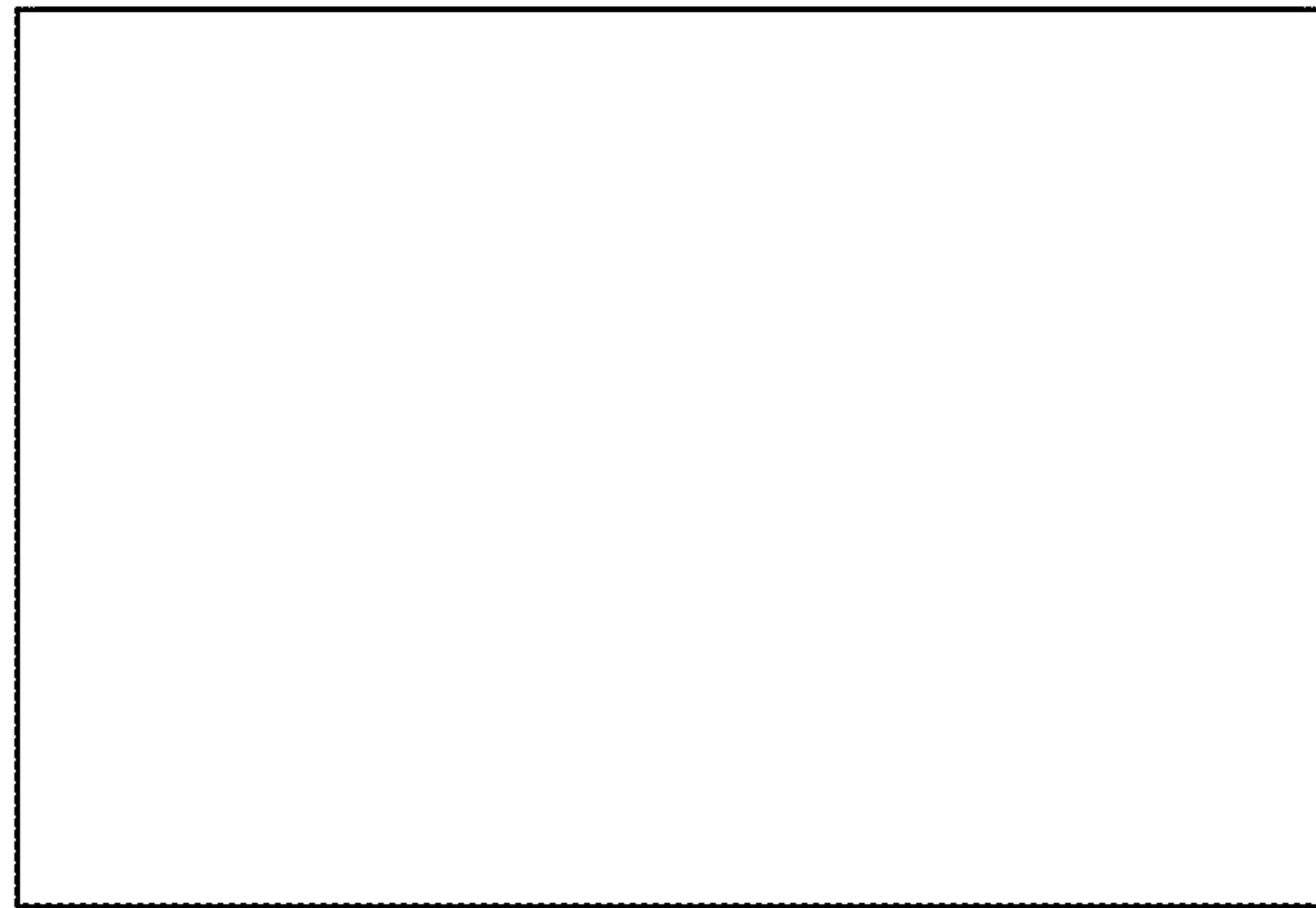

FIG. 5



FIG. 6

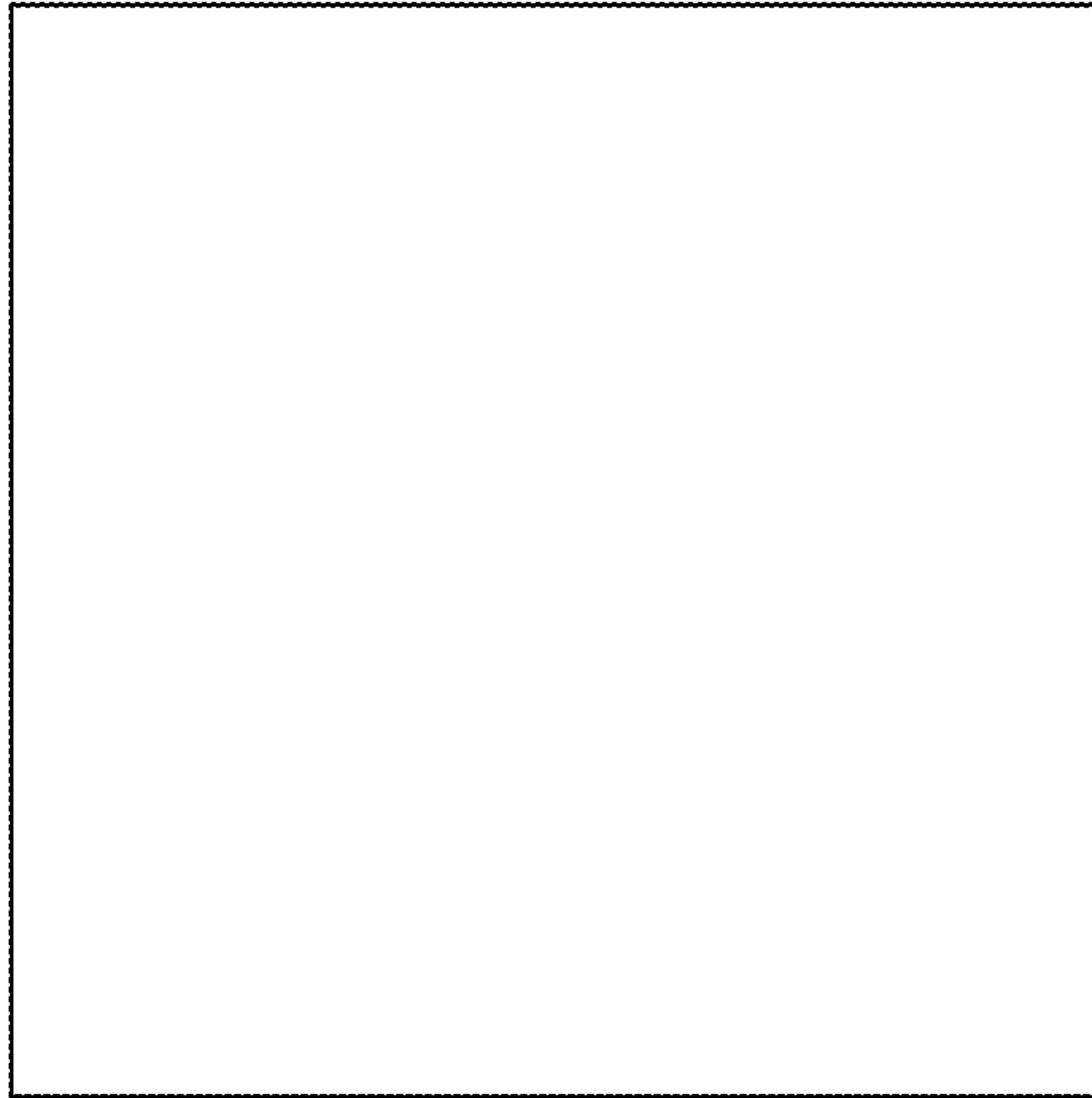

FIG. 7

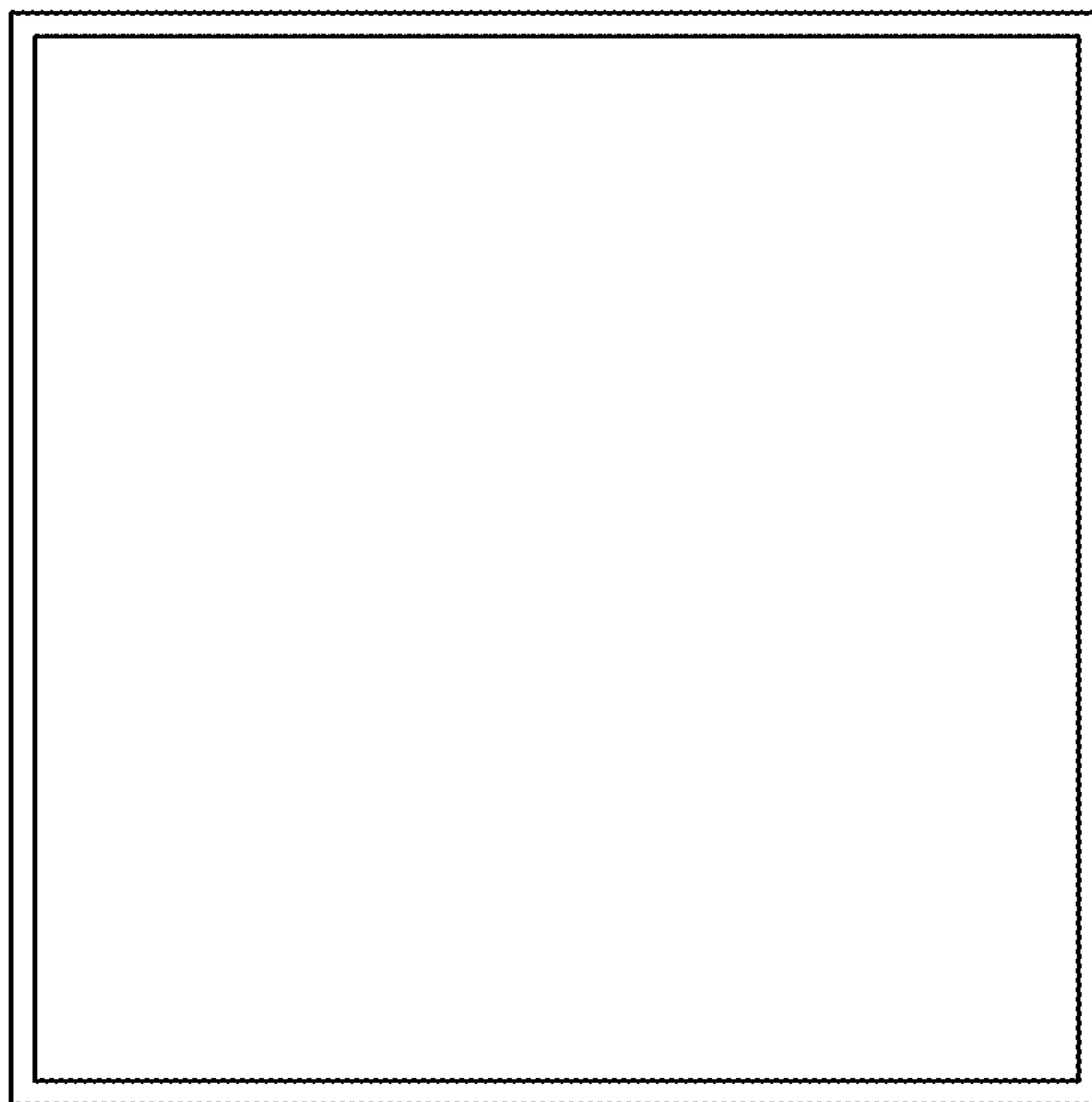

FIG. 8

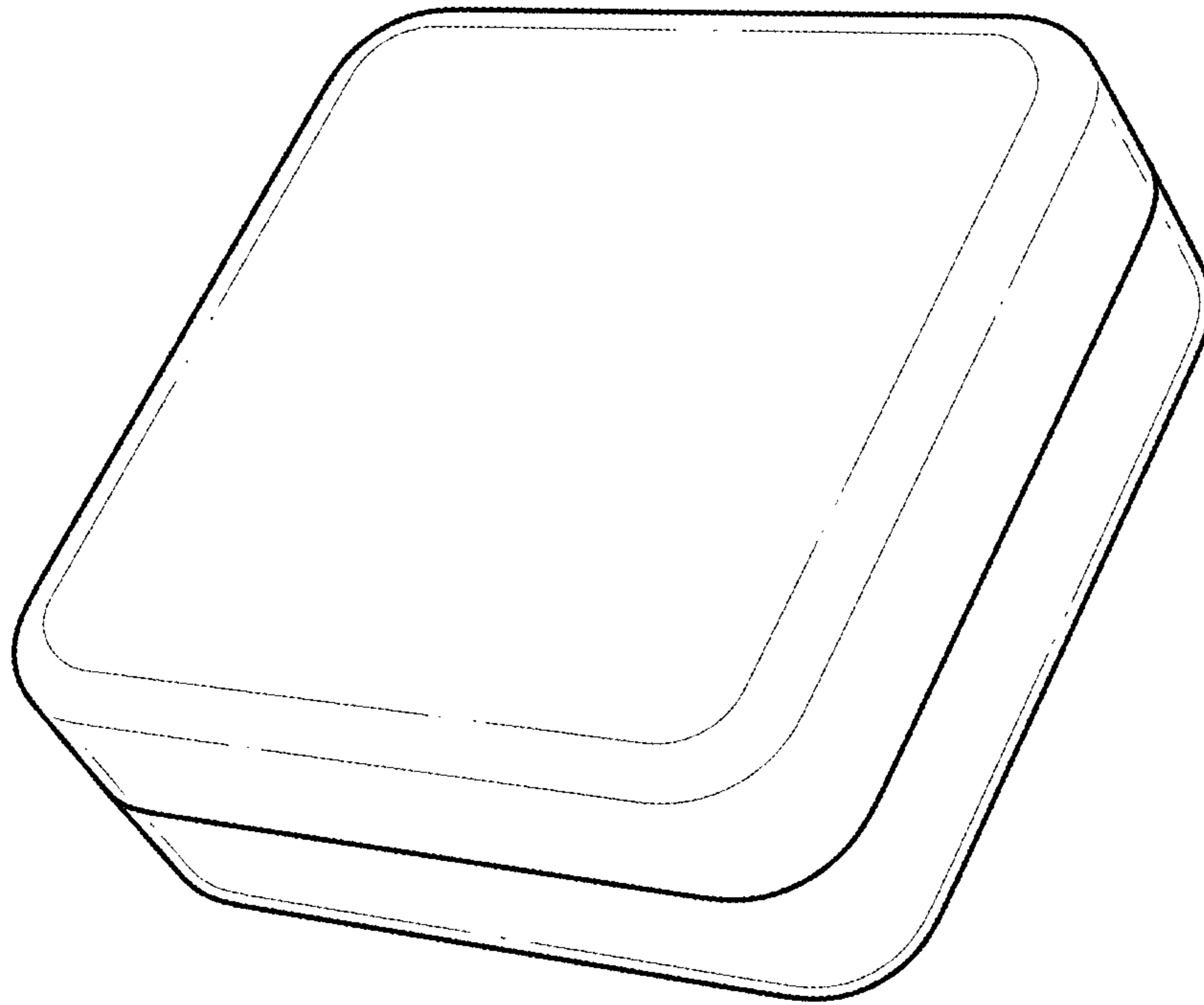

FIG. 9

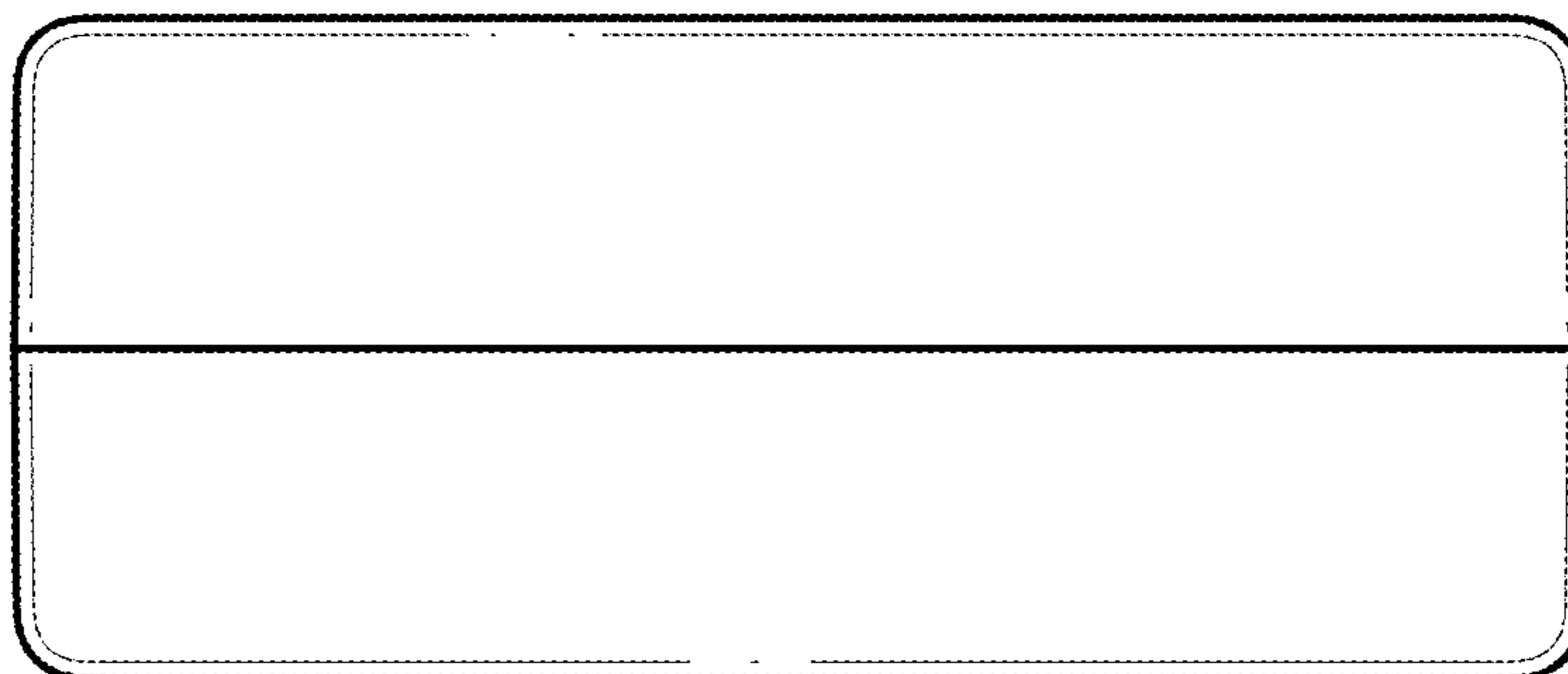

FIG. 10

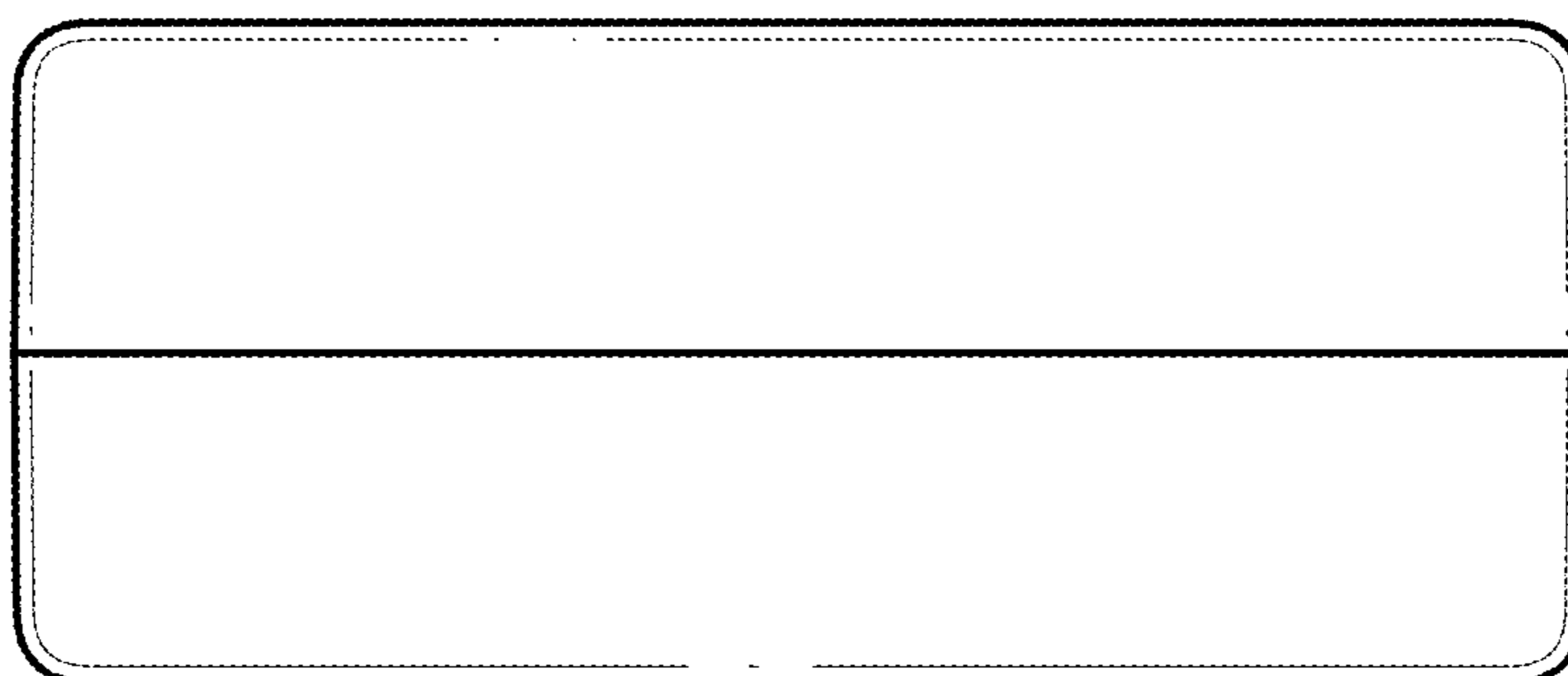

FIG. 11

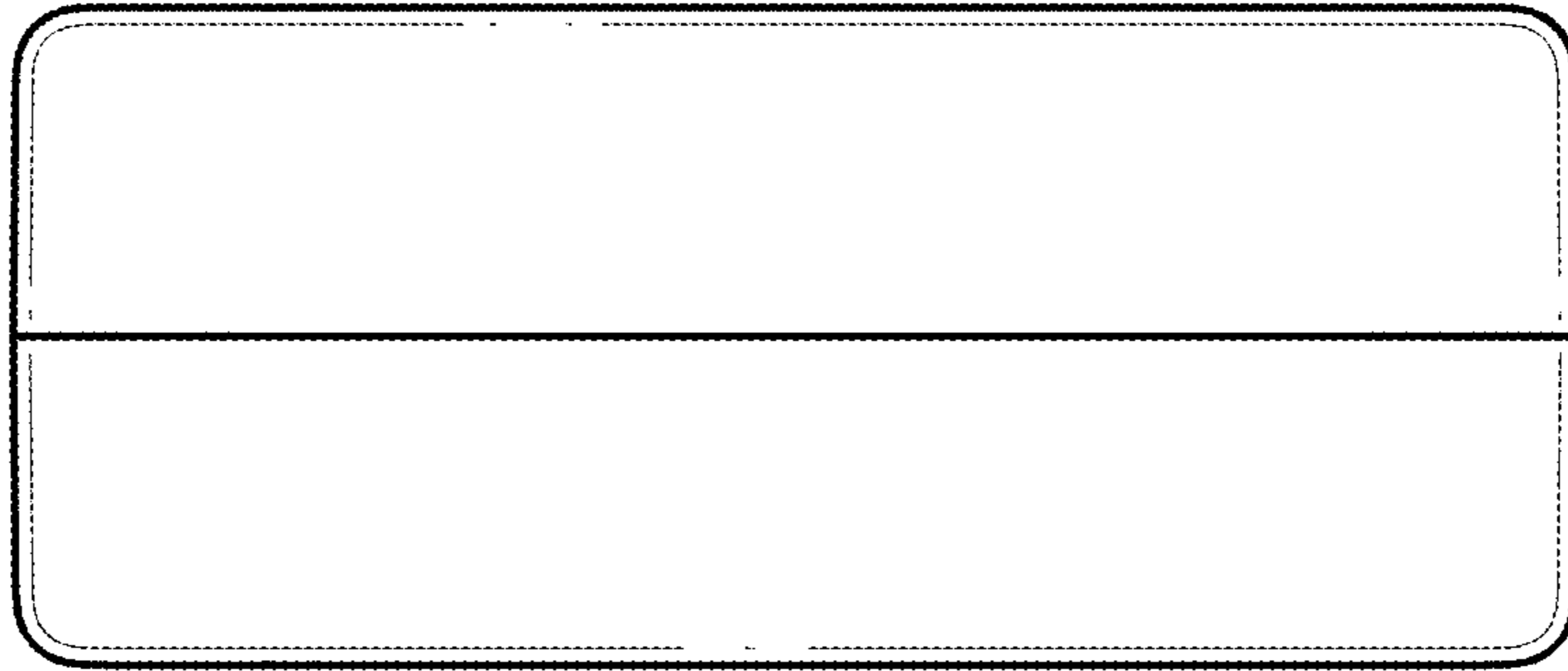

FIG. 12

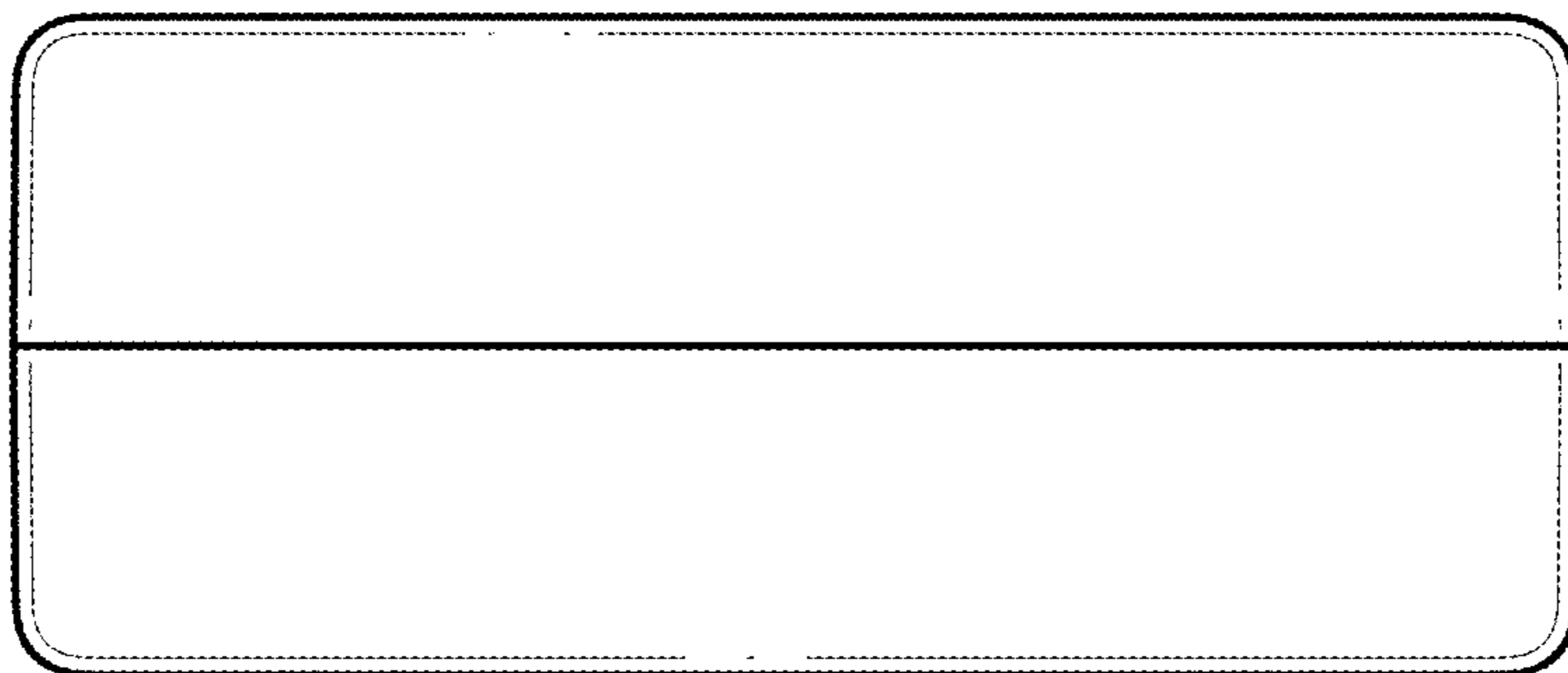

FIG. 13

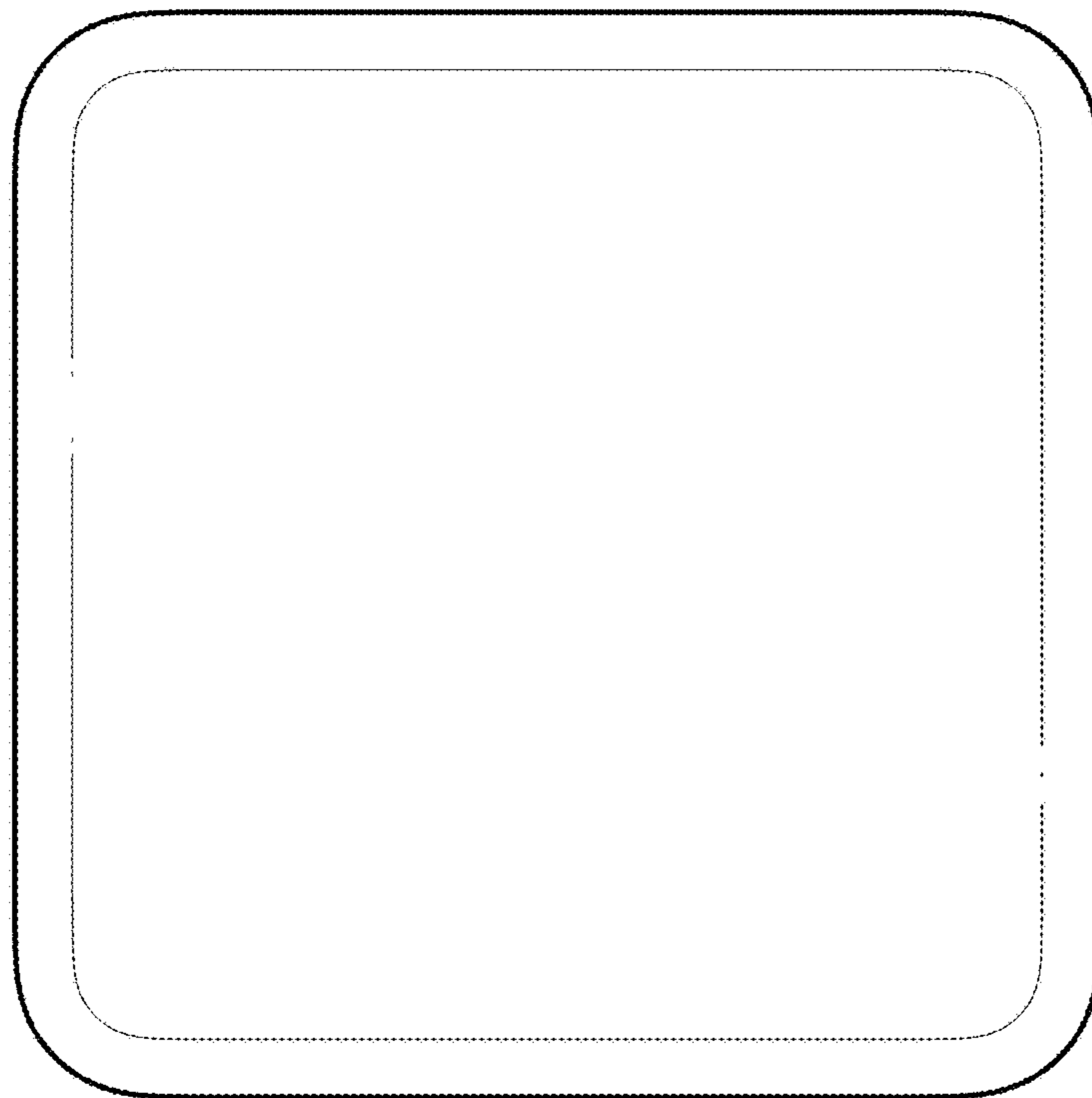

FIG. 14

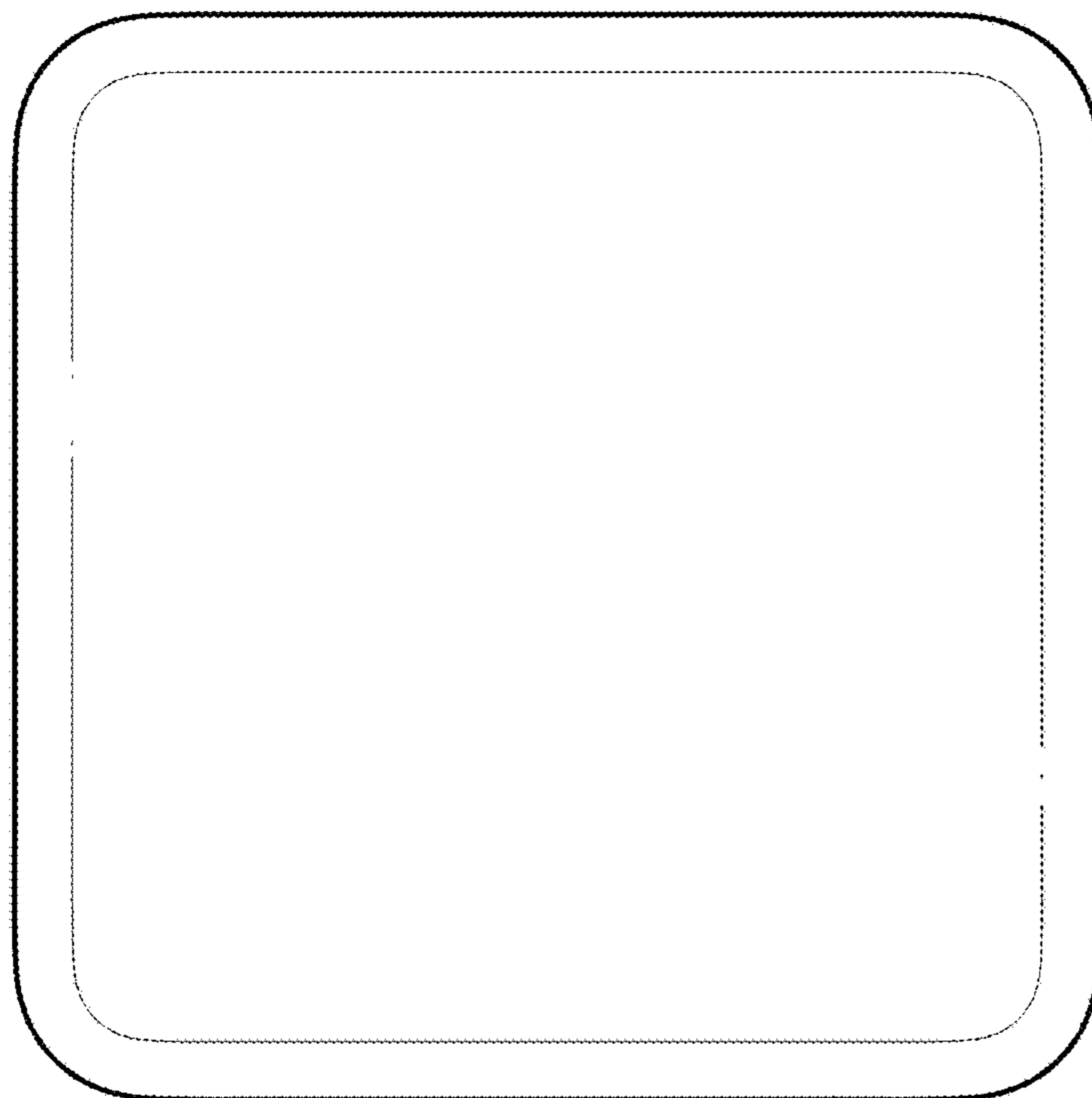

FIG. 15

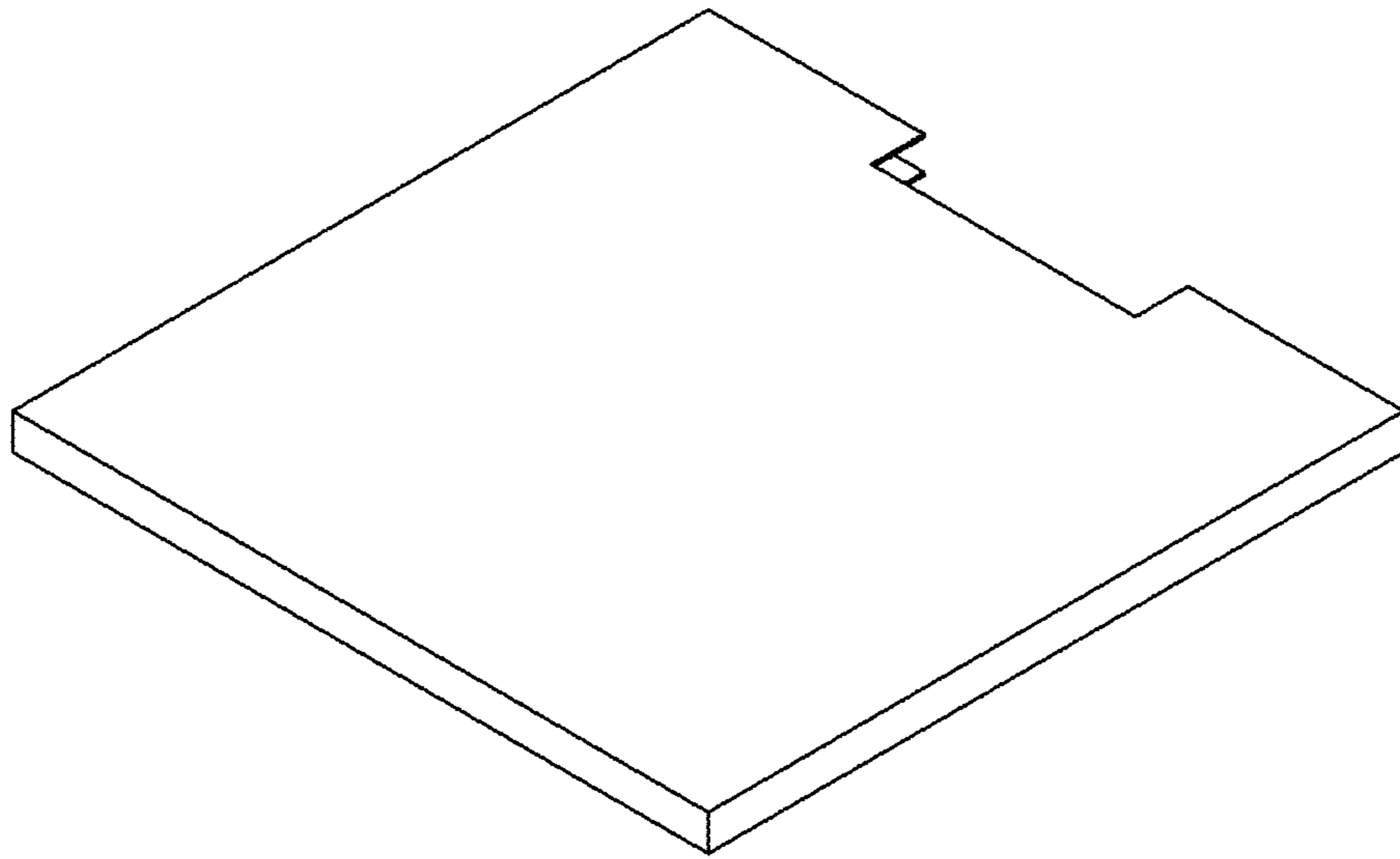

FIG. 16



FIG. 17



FIG. 18



FIG. 19



FIG. 20

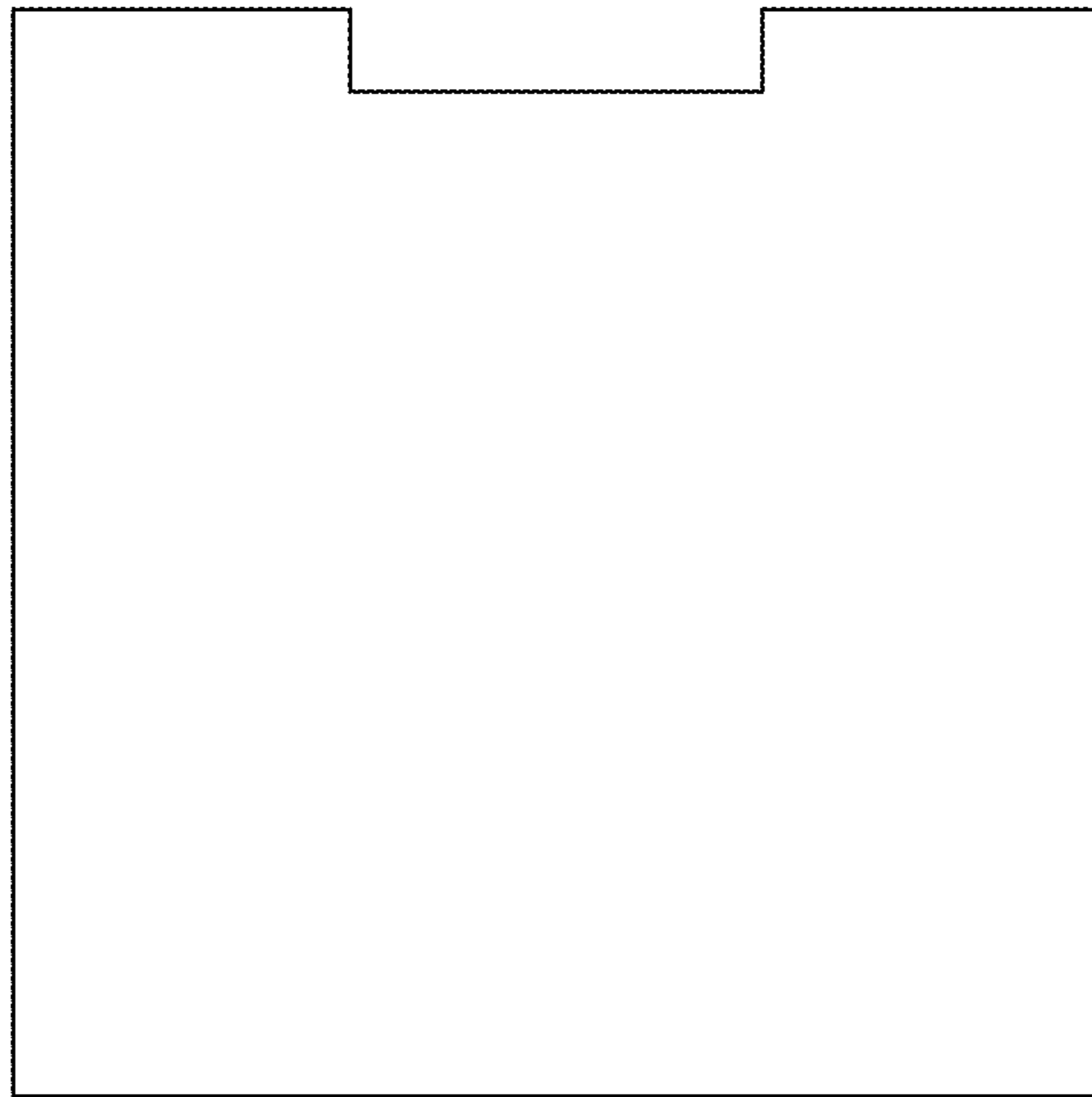

FIG. 21

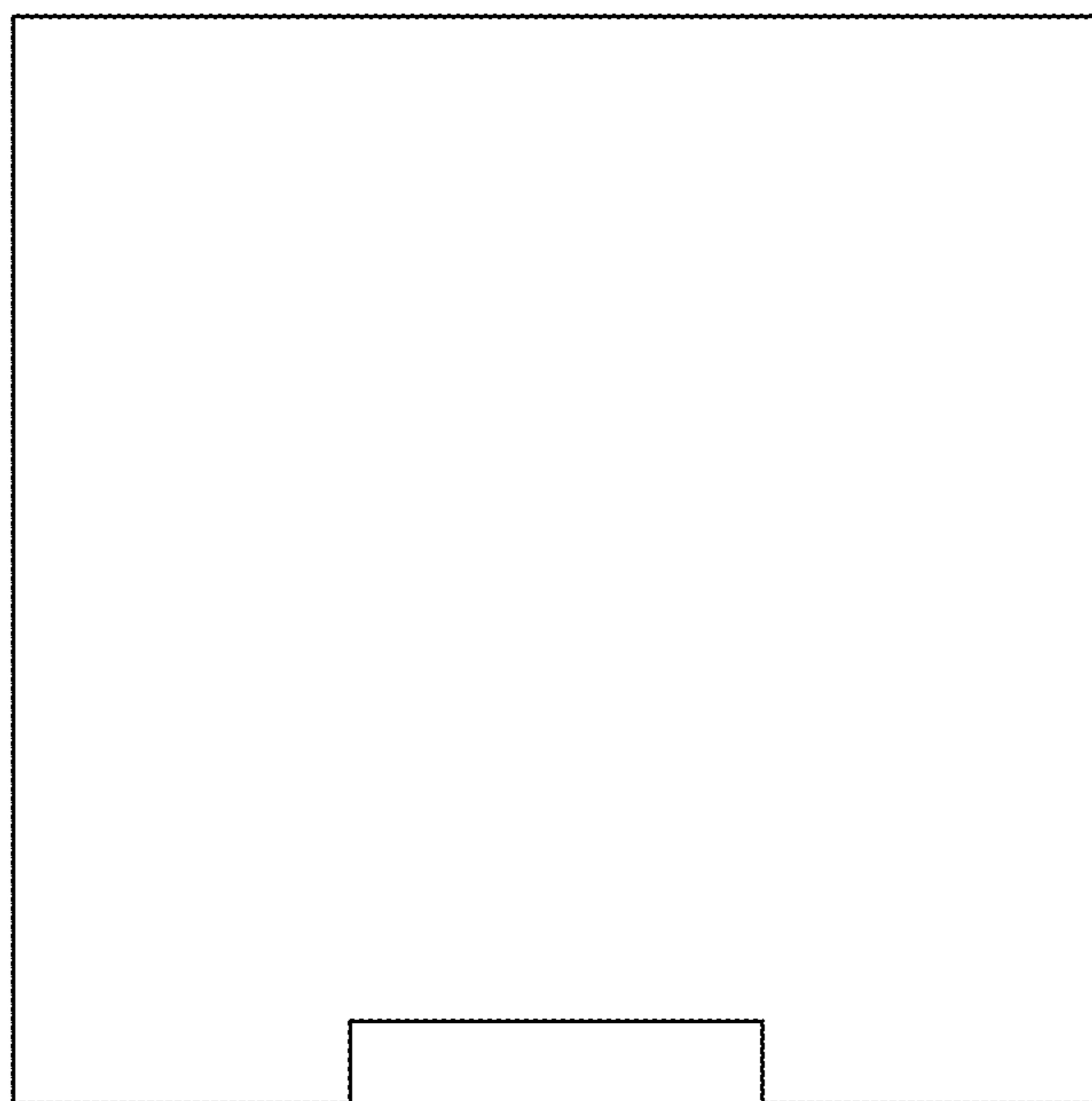

FIG. 22

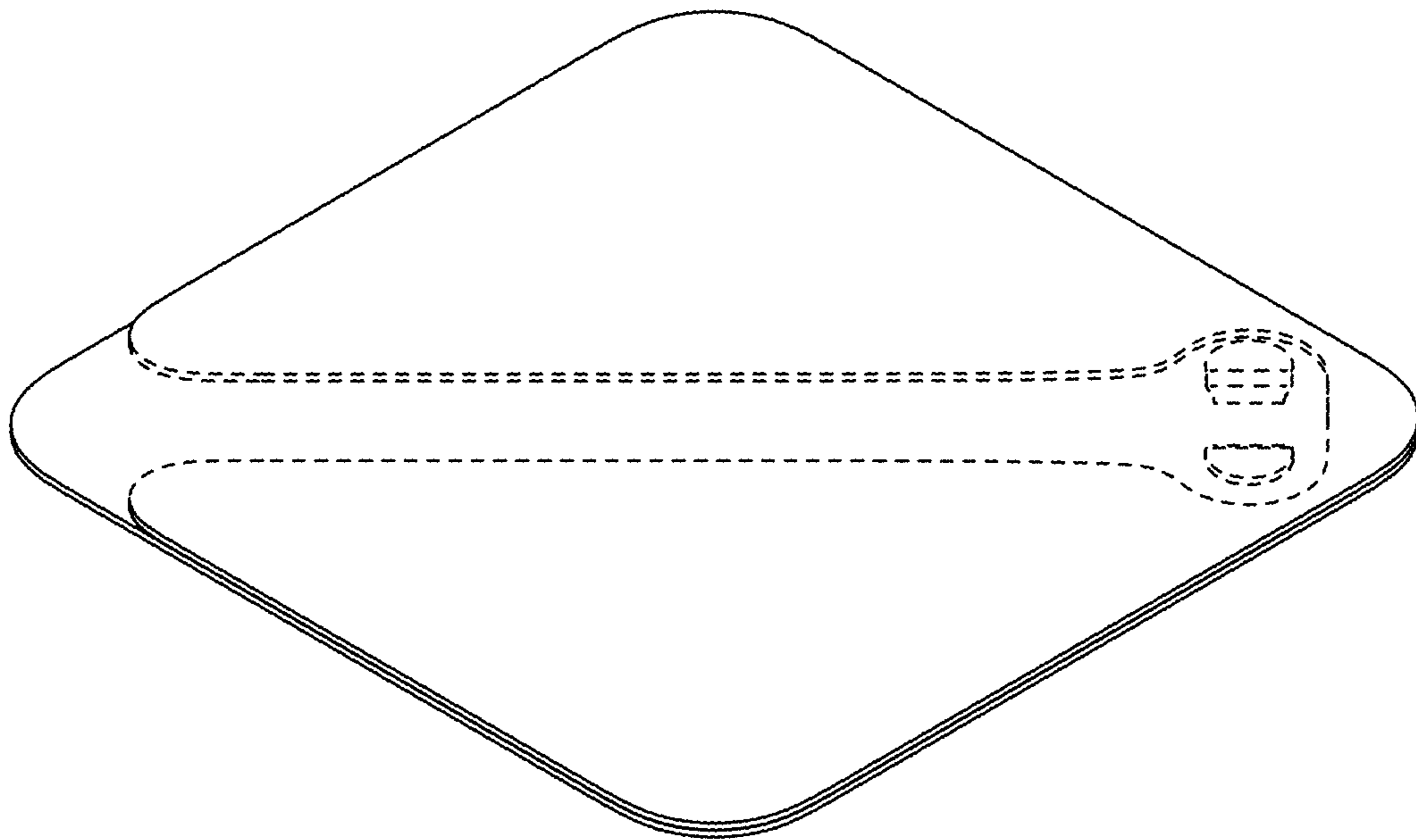

FIG. 23

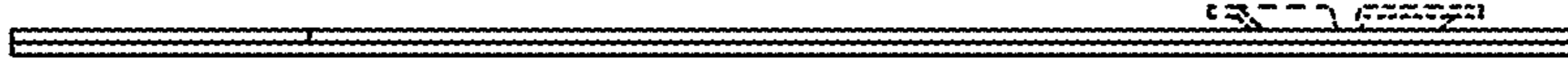

FIG. 24



FIG. 25

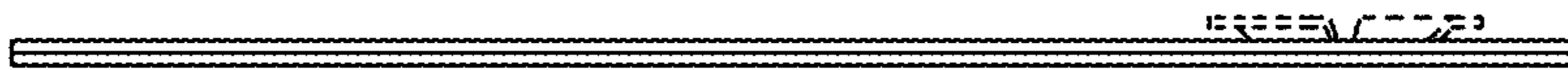

FIG. 26



FIG. 27

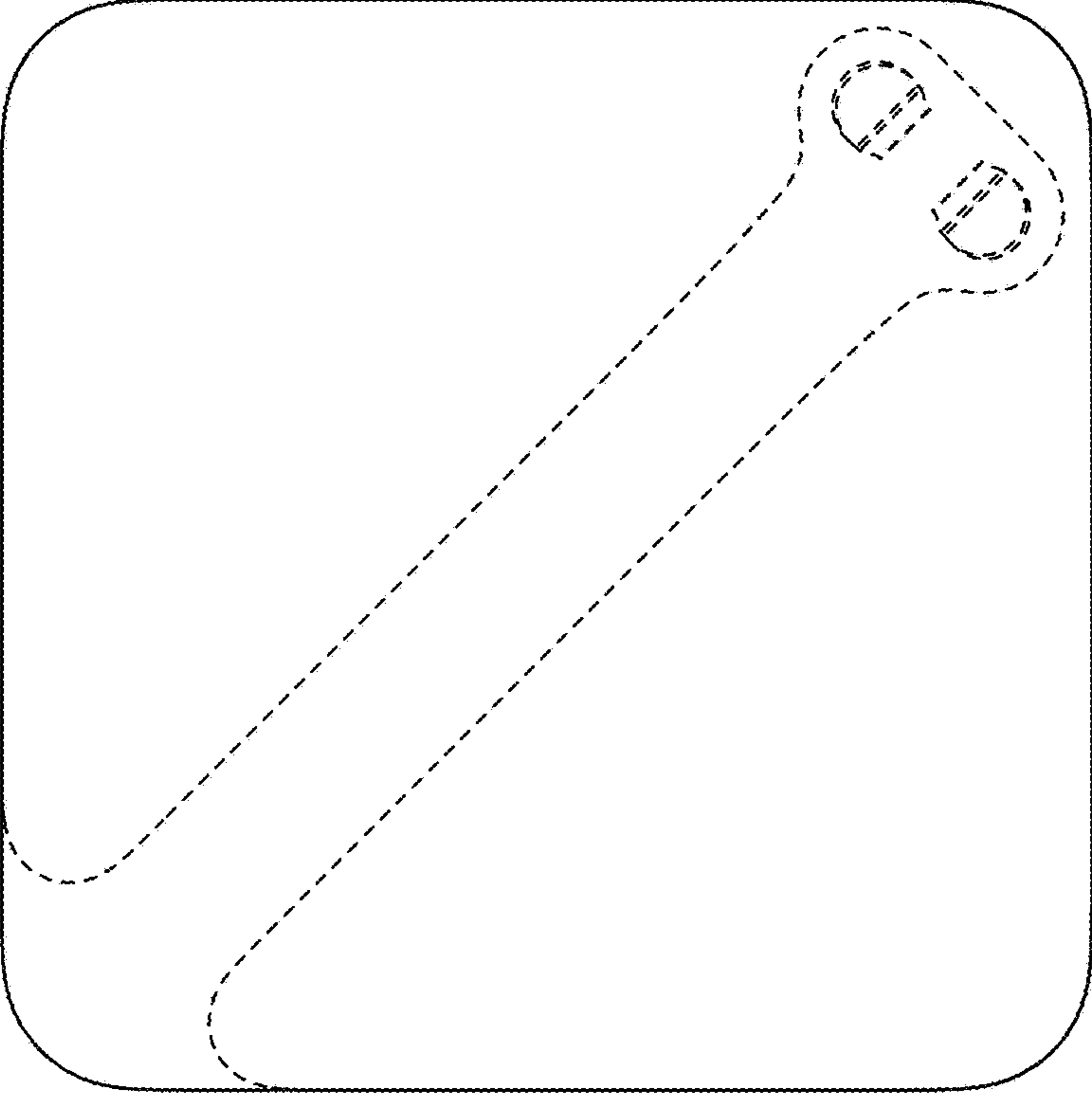

FIG. 28

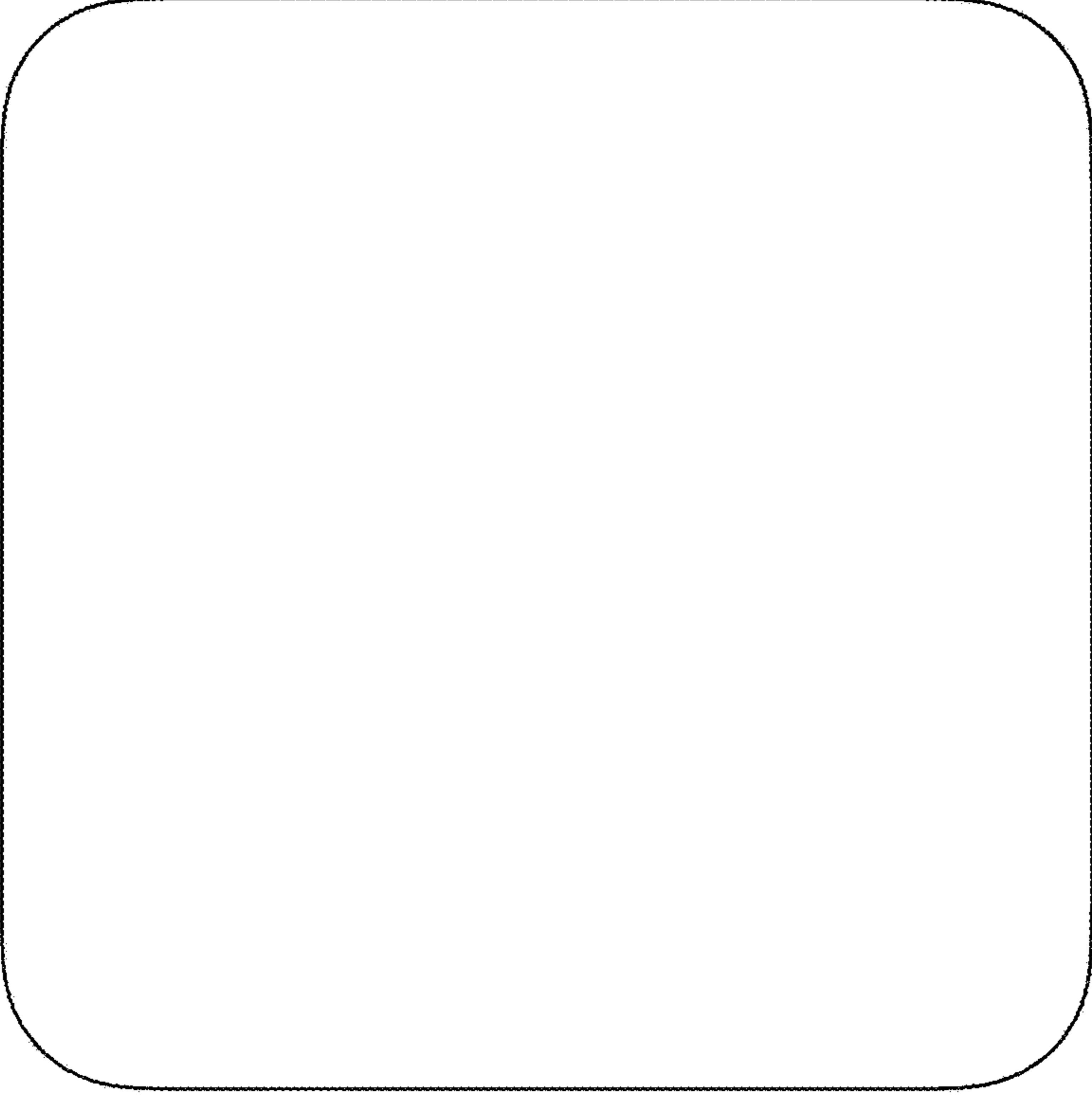

FIG. 29

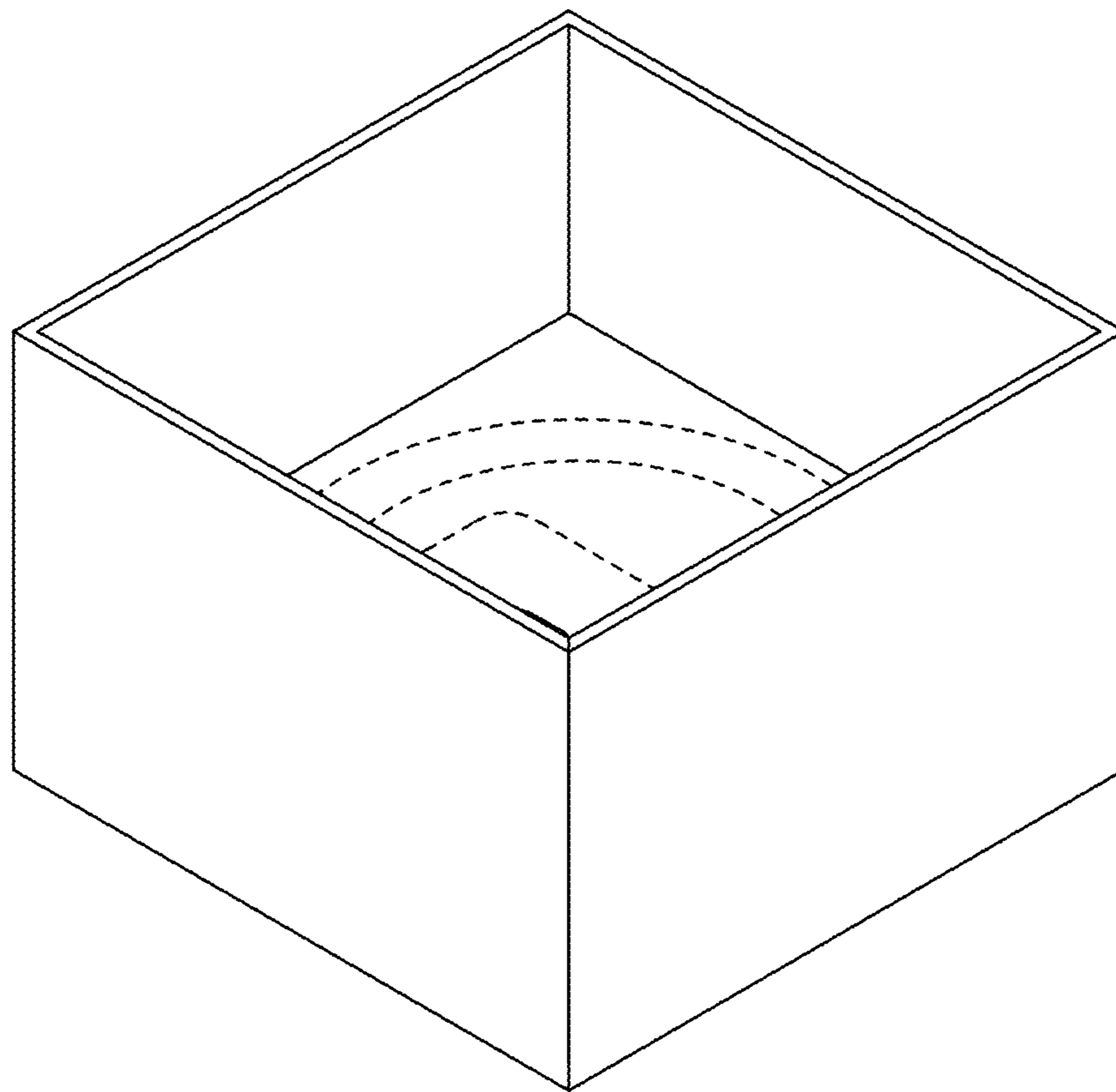

FIG. 30

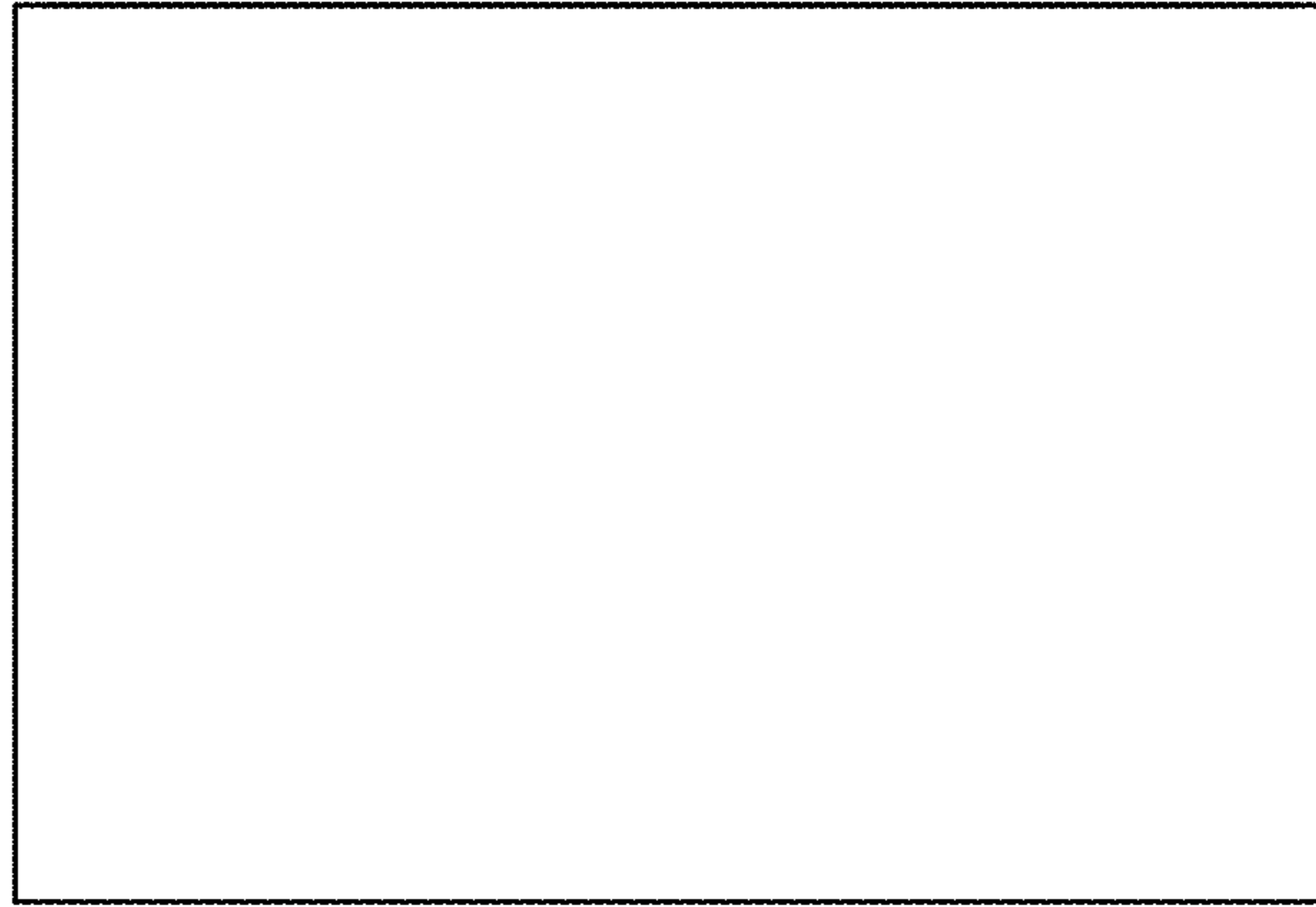

FIG. 31



FIG. 32

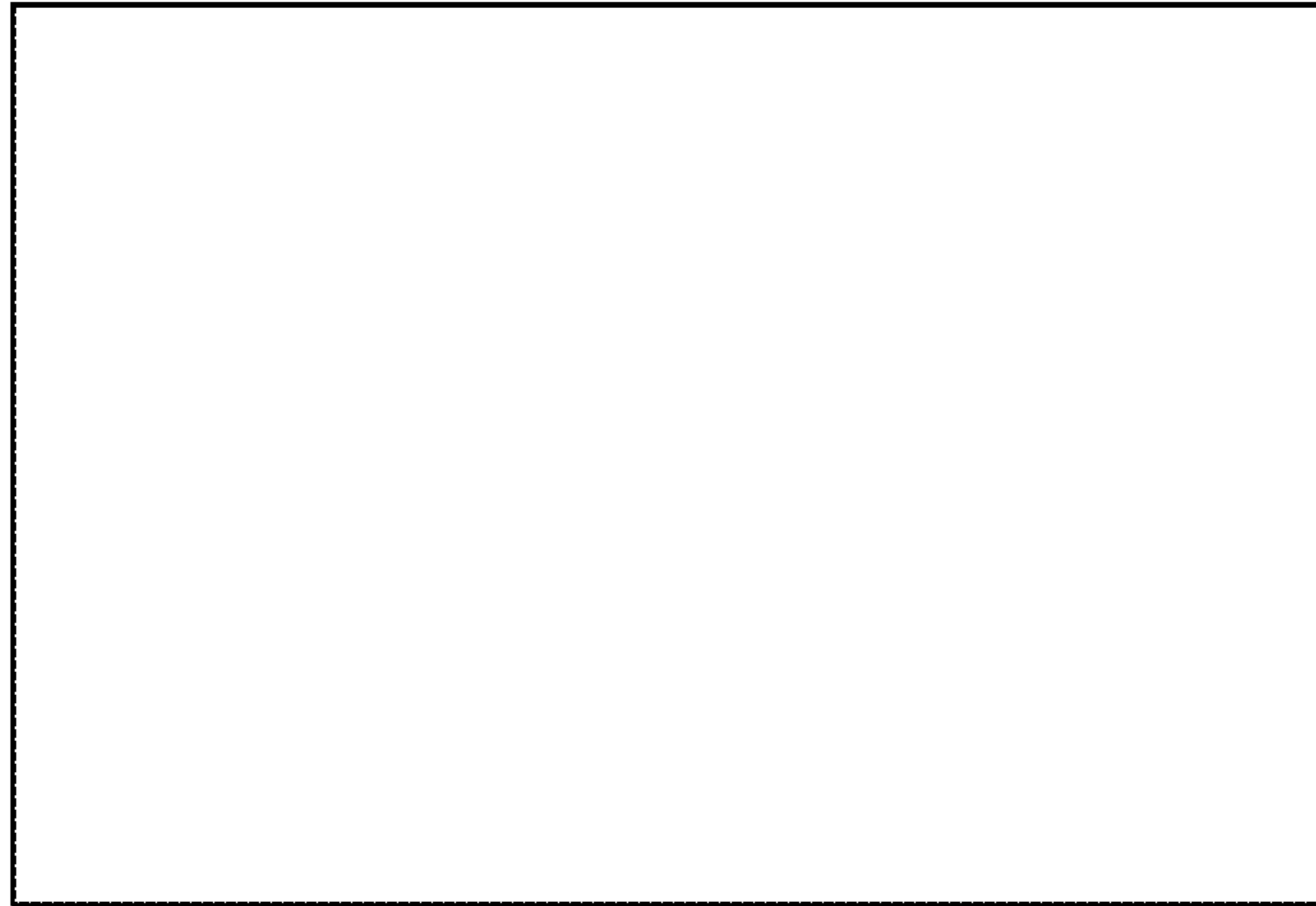

FIG. 33

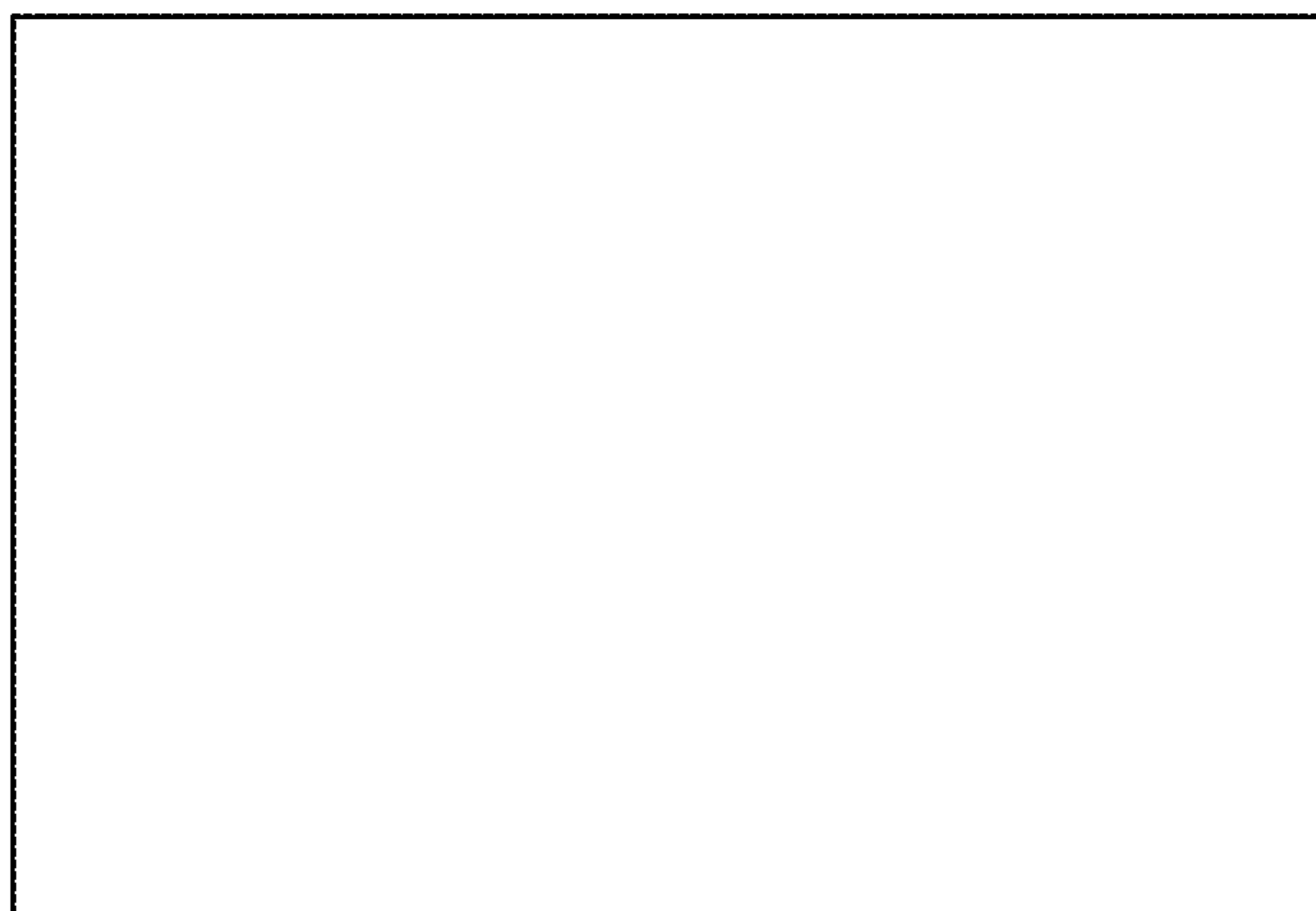

FIG. 34

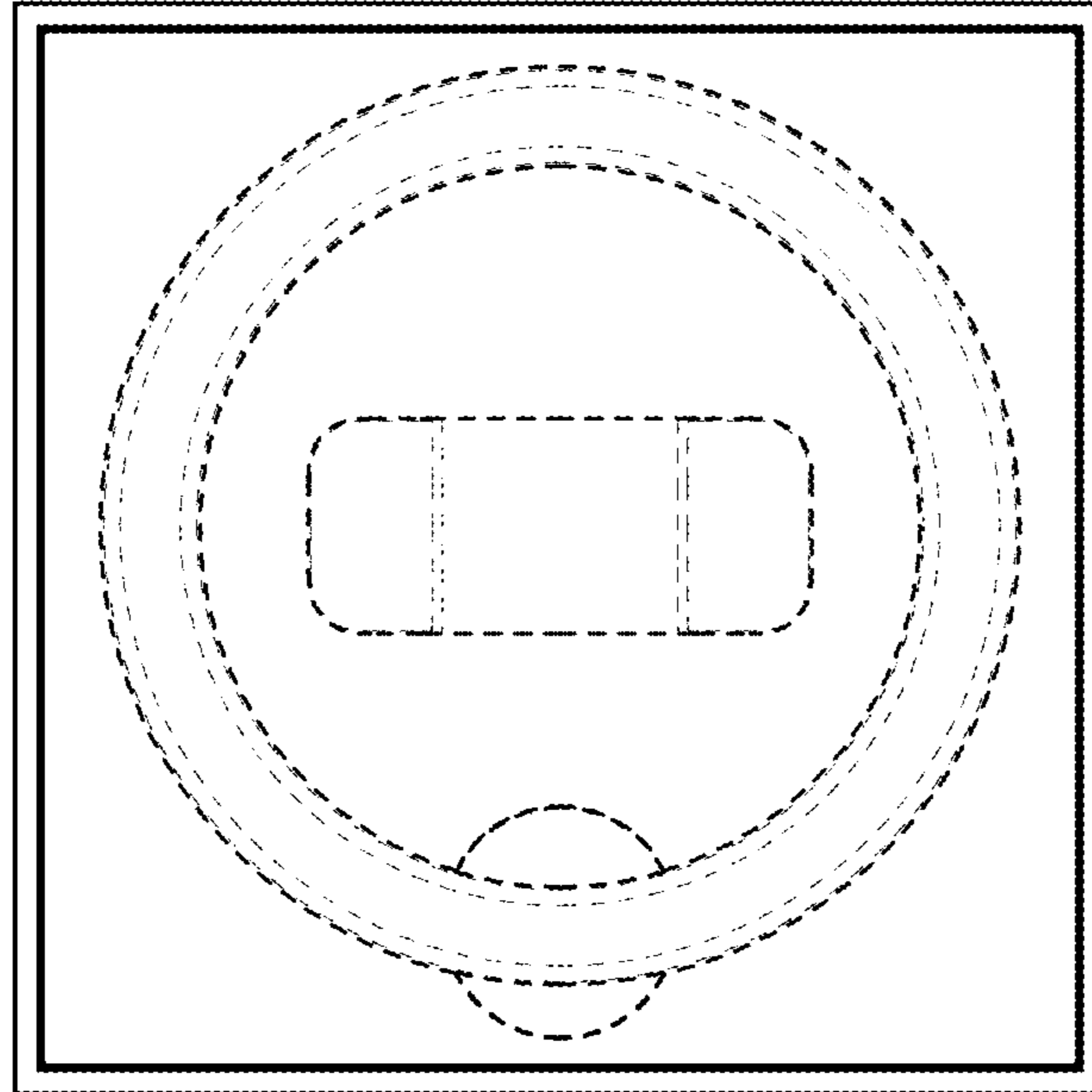

FIG. 35

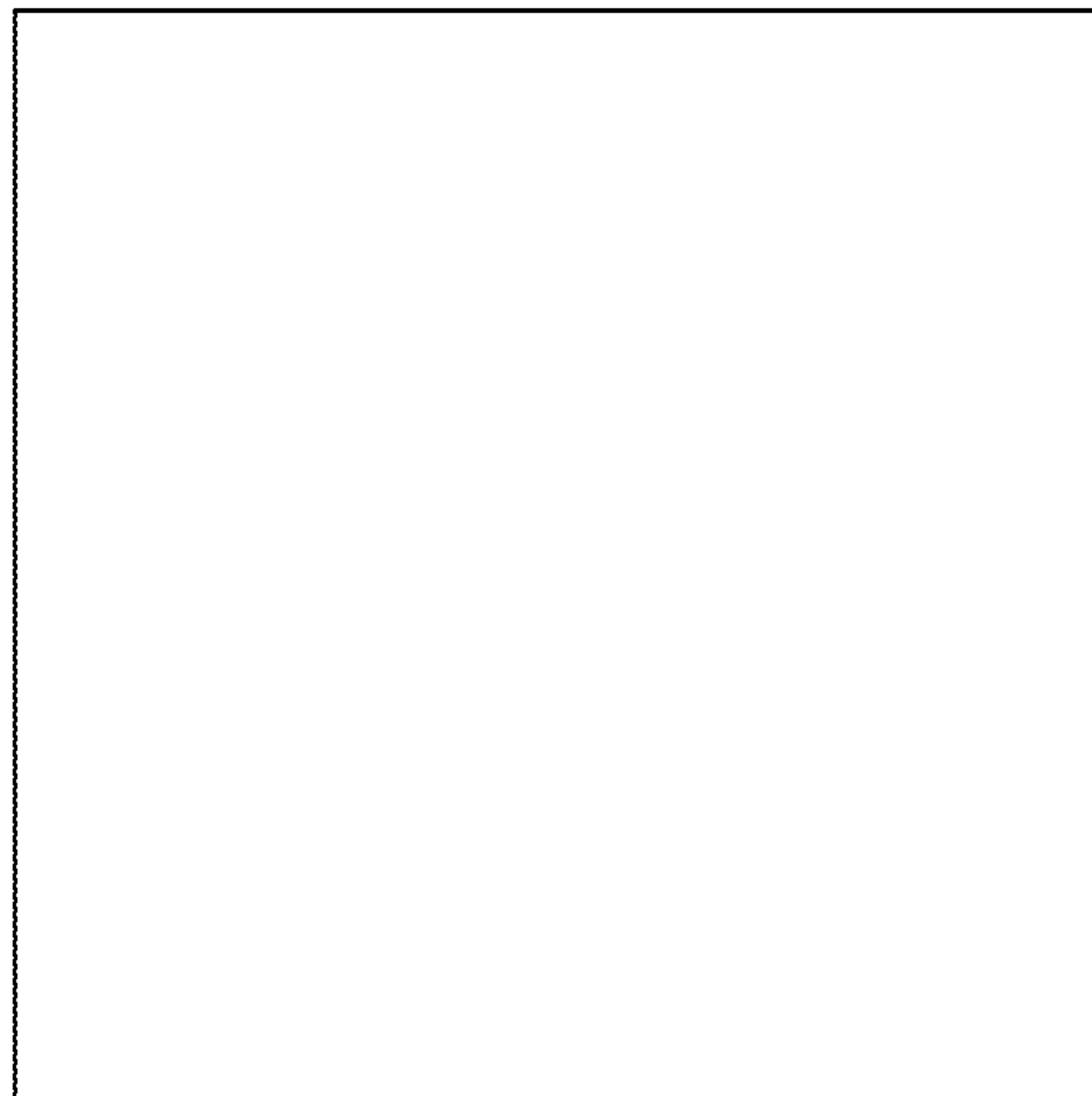

FIG. 36