



US00D802334S

(12) **United States Design Patent** (10) **Patent No.:** **US D802,334 S**  
**Chiarelli** (45) **Date of Patent:** **\*\* Nov. 14, 2017**

(54) **CUSHION**

(56) **References Cited**

(71) Applicants: **Luca Matteo Mario Chiarelli**,  
Boardwalk Meander Estate (ZA);  
**Alessio Chiarelli**, Boardwalk Meander  
Estate (ZA); **Dario Chiarelli**,  
Boardwalk Meander Estate (ZA)

U.S. PATENT DOCUMENTS

D33,613 S \* 11/1900 Hogan et al. .... D6/604  
D33,763 S \* 12/1900 Meinecke et al. .... D6/604  
D94,702 S \* 2/1935 Marksl ..... 5/636  
D277,059 S \* 1/1985 Boone ..... D6/601  
4,726,085 A \* 2/1988 Antonio ..... A47D 15/00  
2/49.4  
D298,456 S \* 11/1988 Leonard ..... 5/602

(72) Inventor: **Luca Matteo Mario Chiarelli**,  
Boardwalk Meander Estate (ZA)

(Continued)

(73) Assignees: **Luca Matteo Mario Chiarelli**,  
Boardwalk Meander Estate (ZA);  
**Alessio Chiarelli**, Boardwalk Meander  
Estate (ZA); **Dario Chiarelli**,  
Boardwalk Meander Estate (ZA)

*Primary Examiner* — Eric Goodman

*Assistant Examiner* — Sanjeev Paul

(74) *Attorney, Agent, or Firm* — Renner, Kenner; Arthur  
M. Reginelli

(\*\*) Term: **15 Years**

(21) Appl. No.: **29/580,437**

(57) **CLAIM**

(22) Filed: **Oct. 10, 2016**

The ornamental design for a cushion, as shown and  
described.

(30) **Foreign Application Priority Data**

Apr. 13, 2016 (ZA) ..... A2016/00523

(51) **LOC (10) Cl.** ..... **06-09**

(52) **U.S. Cl.**  
USPC ..... **D6/601**

(58) **Field of Classification Search**  
USPC ..... D6/333, 349, 355, 375, 388, 512, 563,  
D6/564, 595, 596, 601, 604, 611, 707,  
D6/715, 716, 716.1; D24/183–185, 234;  
D21/803, 804, 805, 809; 5/401, 420,  
5/600, 630, 631, 632, 633, 635, 636, 638,  
5/639, 646, 652, 652.1, 655, 703, 730;  
297/1, 2, 4, 93, 180.11, 195.1, 195.11,  
297/195.13, 393, 397, 452.12, 452.14,  
297/452.15, 452.21, 452.24, 452.26,  
297/452.48, 452.62, 482  
CPC ..... A47G 9/10; A47G 9/1009; A47G 9/1027;  
A47G 9/1045; A47G 9/1063; A47G  
9/1072; A47G 9/1081

See application file for complete search history.

**DESCRIPTION**

FIG. 1 is a top, front, left side perspective view of a cushion  
showing my new design;  
FIG. 2 is a bottom, right side perspective view thereof;  
FIG. 3 is a top, right side perspective view thereof;  
FIG. 4 is a bottom, left side perspective view thereof;  
FIG. 5 is a left side elevational view thereof;  
FIG. 6 is a right side elevational view thereof;  
FIG. 7 is a bottom plan view thereof;  
FIG. 8 is a top plan view thereof;  
FIG. 9 is a front side elevational view thereof;  
FIG. 10 is a rear side elevational view thereof;  
FIG. 11 is a front cross-sectional view thereof taken along  
line 11-11 of FIG. 7; and,  
FIG. 12 is a right side cross-sectional view thereof taken  
along line 12-12 of FIG. 9.

**1 Claim, 7 Drawing Sheets**

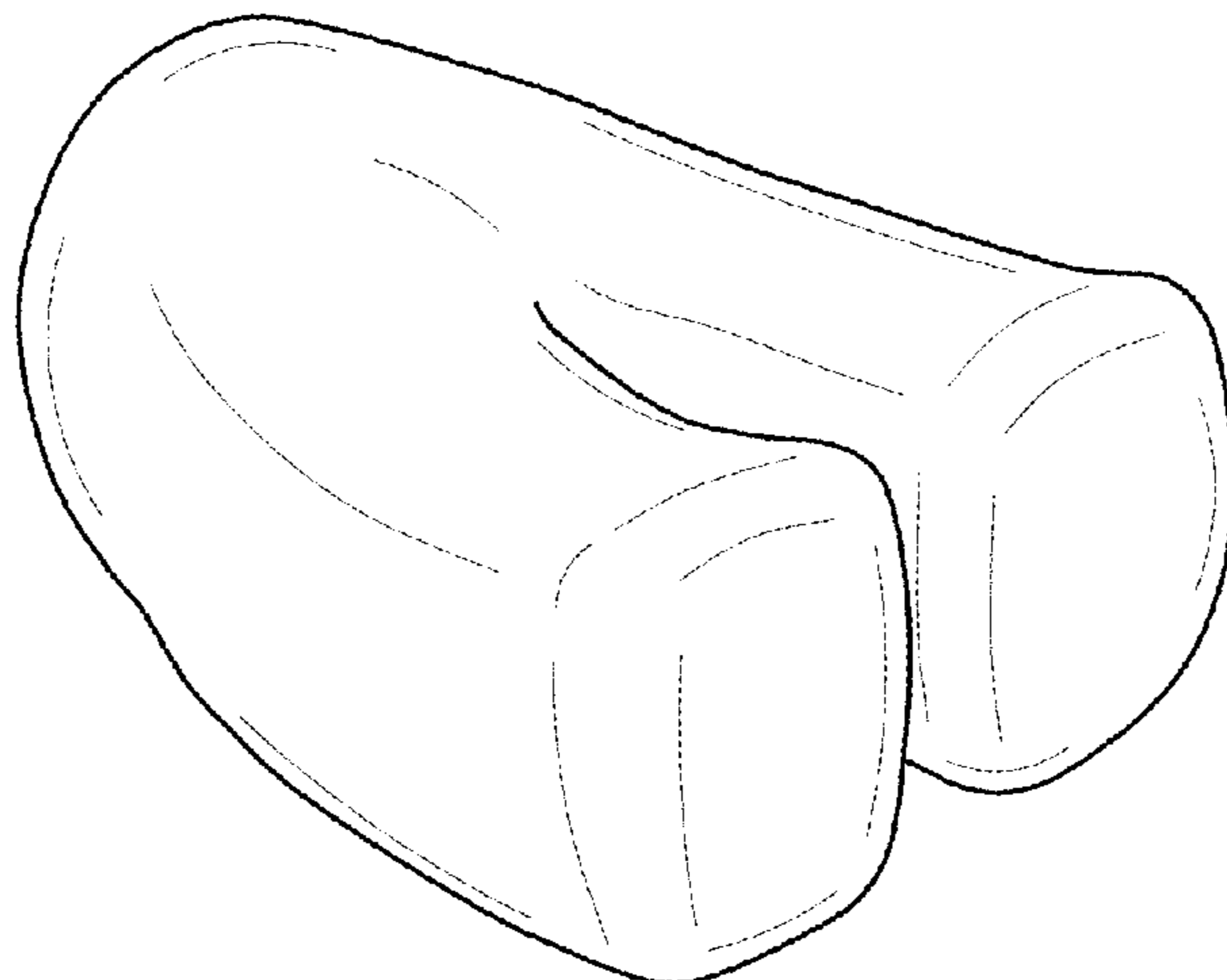

(56)

References Cited

U.S. PATENT DOCUMENTS

5,257,429 A *	11/1993	Genis	.....	A47C 7/383	D522,300 S *	6/2006	Roberts	.....	A47C 7/383
				5/636					D6/601
D396,980 S *	8/1998	Novros	.....	D6/601	D583,181 S *	12/2008	Denson-Willis	.....	D6/601
5,970,546 A *	10/1999	Danis	.....	A47C 20/026	D637,439 S *	5/2011	Mettler	.....	D6/601
				5/636	D663,002 S *	7/2012	Zucchelli	.....	D21/803
D416,745 S *	11/1999	Noyes	.....	D6/601	D669,724 S *	10/2012	Kokoshari	.....	D6/601
D419,024 S *	1/2000	Lenahan	.....	D6/601	D705,431 S *	5/2014	Abramson	.....	D24/184
6,009,577 A *	1/2000	Day	.....	A47C 7/383	D746,080 S *	12/2015	Mittelstadt	.....	D6/601
				5/636	D755,535 S *	5/2016	Benezri	.....	D6/391
D420,845 S *	2/2000	Rumage	.....	D6/601	D761,595 S *	7/2016	Pulver	.....	D6/601
6,052,848 A *	4/2000	Kelly	.....	A47C 20/025	D769,648 S *	10/2016	Atkinson	.....	D6/601
				5/630	D769,649 S *	10/2016	Vargas	.....	D6/601
6,230,348 B1 *	5/2001	Patrikakis	.....	A47C 7/383	D770,806 S *	11/2016	Canna	.....	D6/601
				5/636	D782,220 S *	3/2017	Little	.....	D6/601
6,230,349 B1 *	5/2001	Silver	.....	A47C 7/383	D787,233 S *	5/2017	Wang	.....	D6/601
				297/393	D791,508 S *	7/2017	Chen	.....	D6/601
D450,517 S *	11/2001	Darling	.....	D6/596	2006/0207029 A1 *	9/2006	Bell	.....	A47D 15/00
6,760,934 B1 *	7/2004	Leach	.....	A47C 20/021					5/655
				5/631	2015/0173524 A1 *	6/2015	McQuilton	.....	A47C 20/02
									5/652.1
					2015/0314715 A1 *	11/2015	Kilgore	.....	A47C 7/383
									5/636

\* cited by examiner

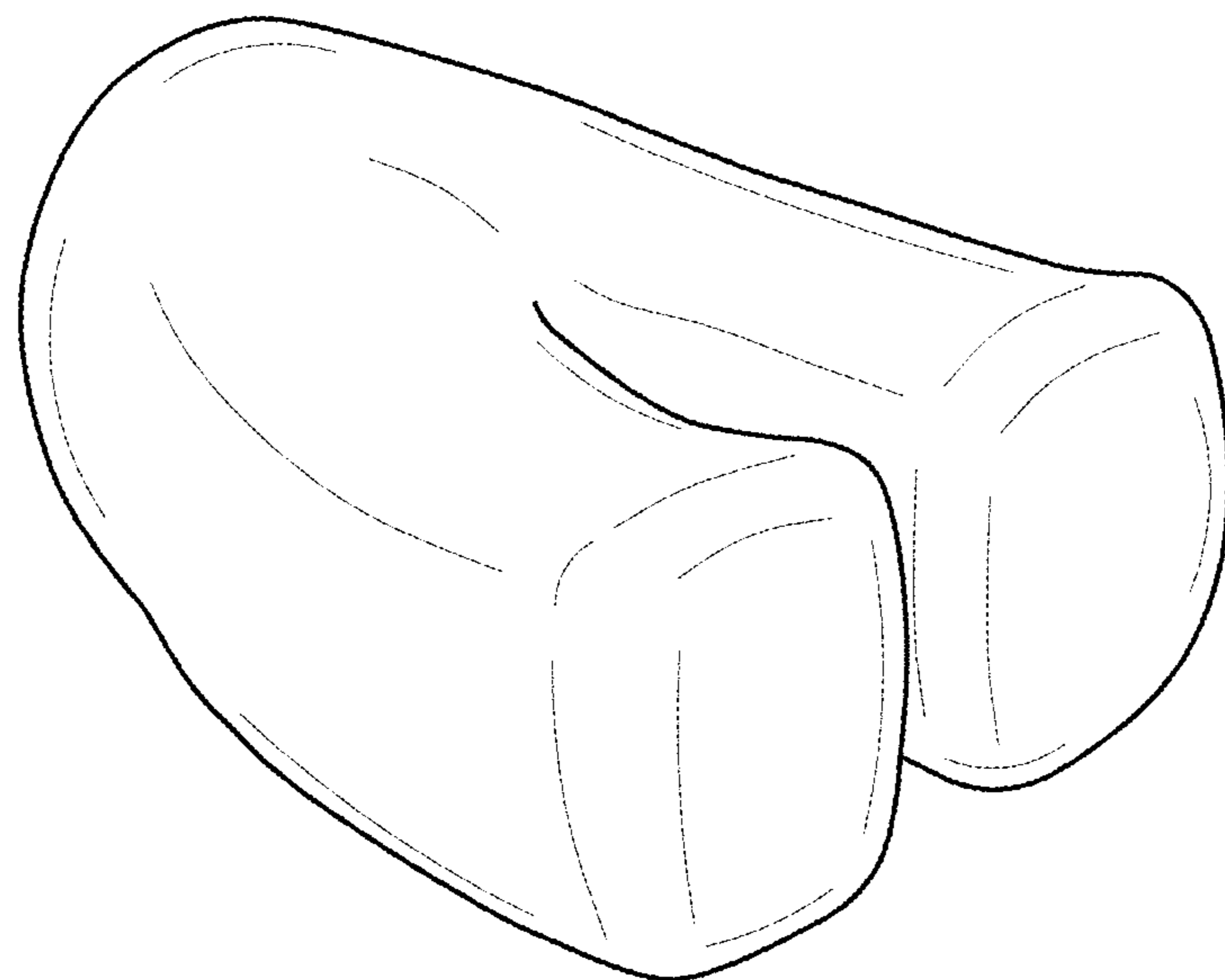

FIG. 1

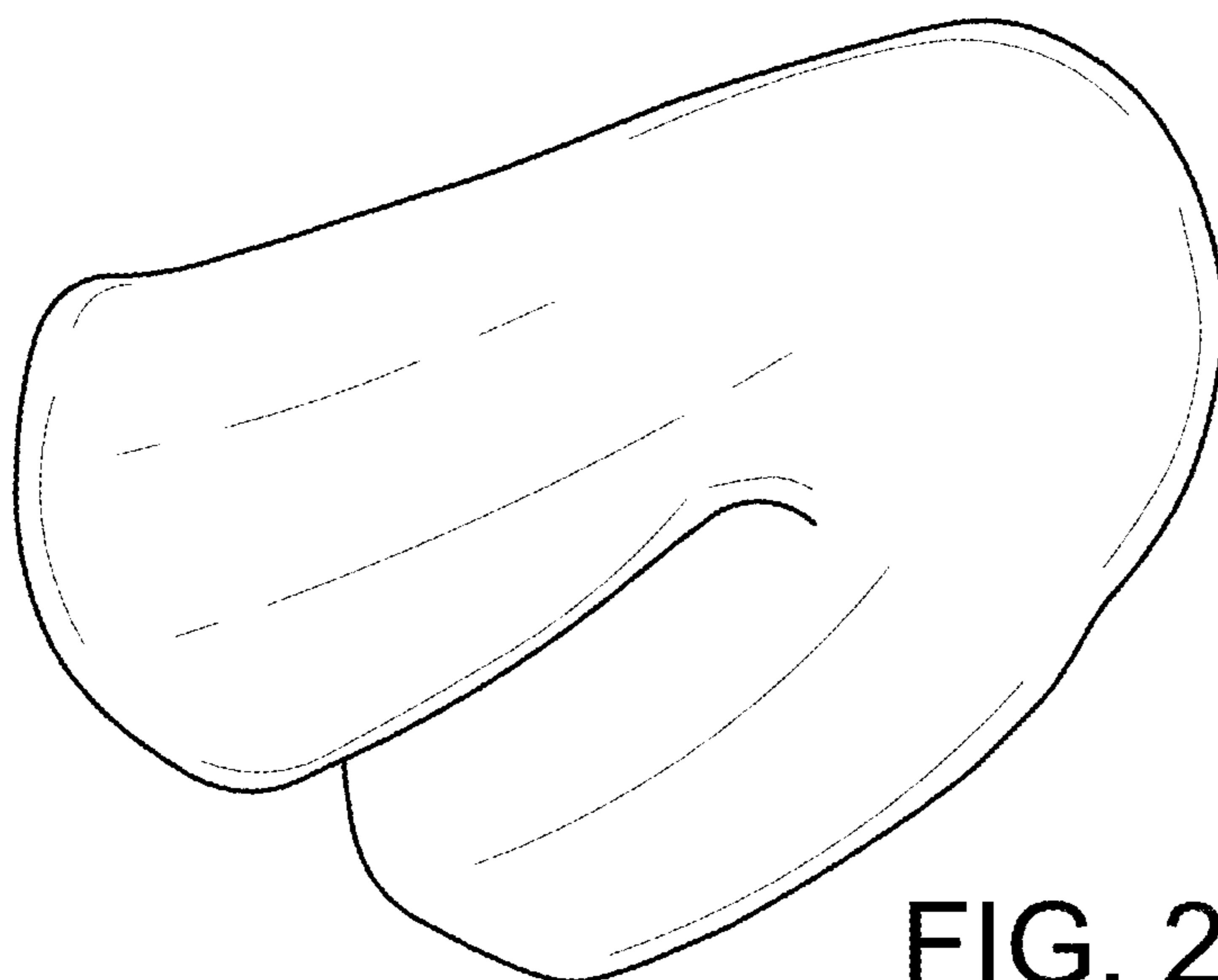

FIG. 2

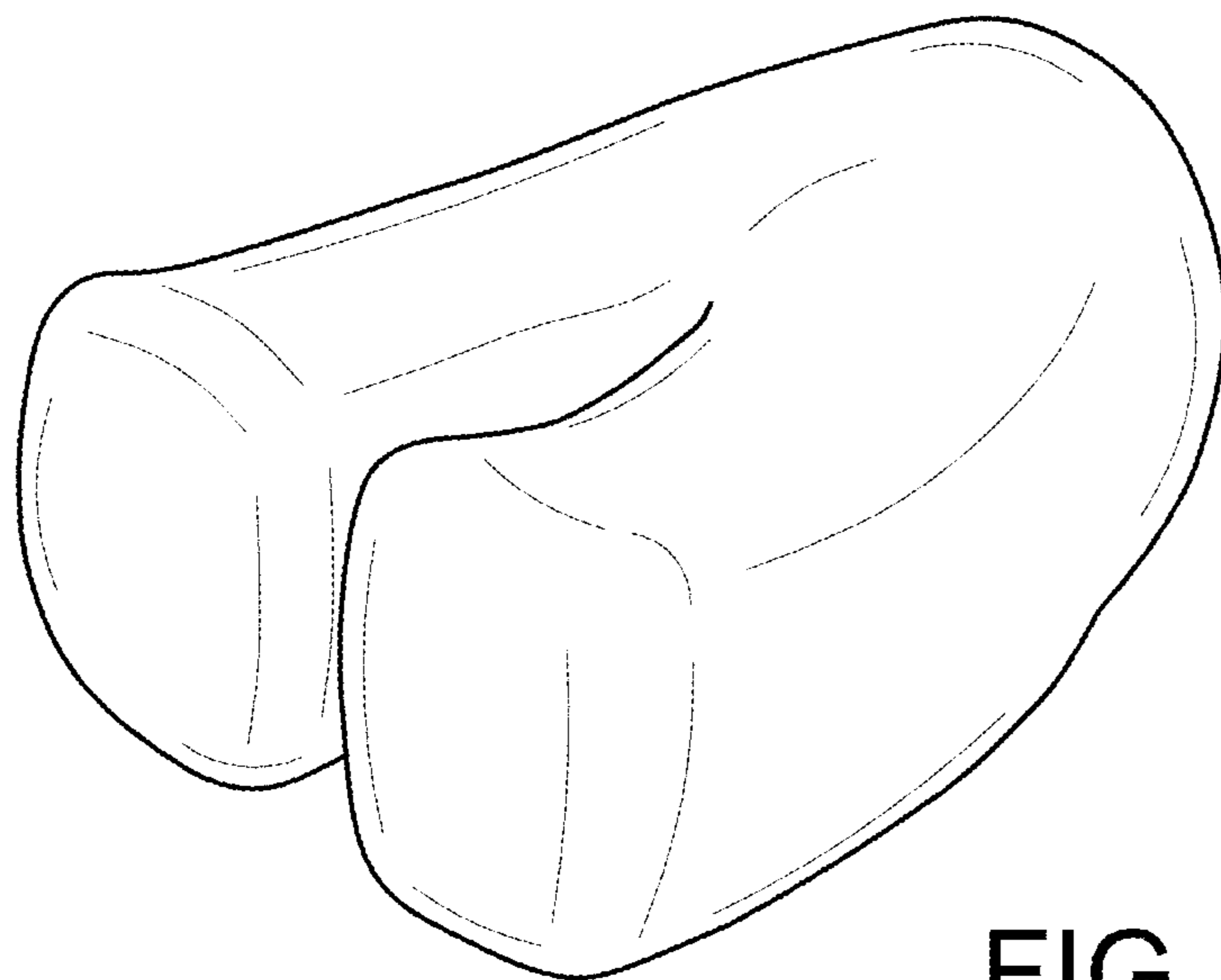

FIG. 3

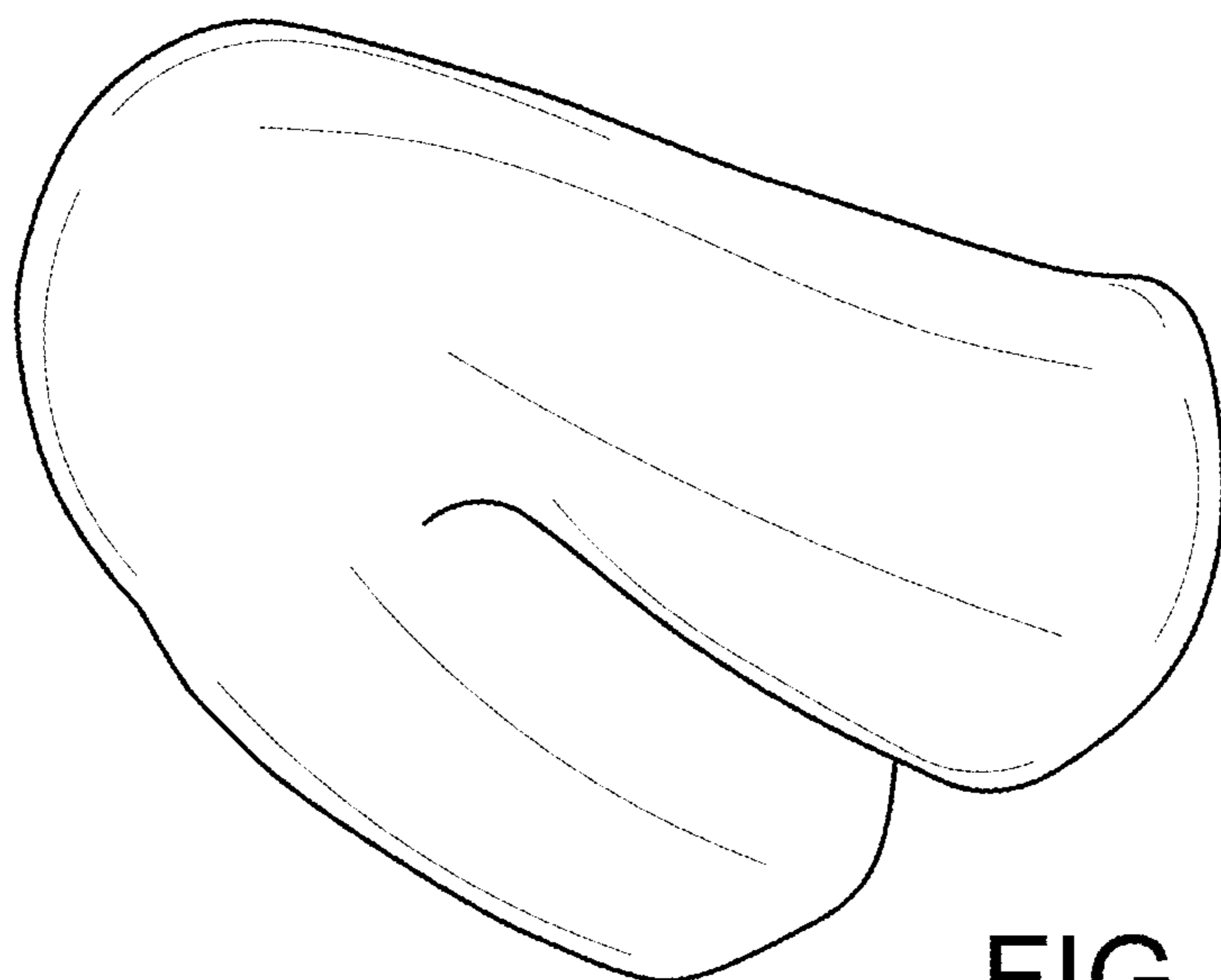

FIG. 4

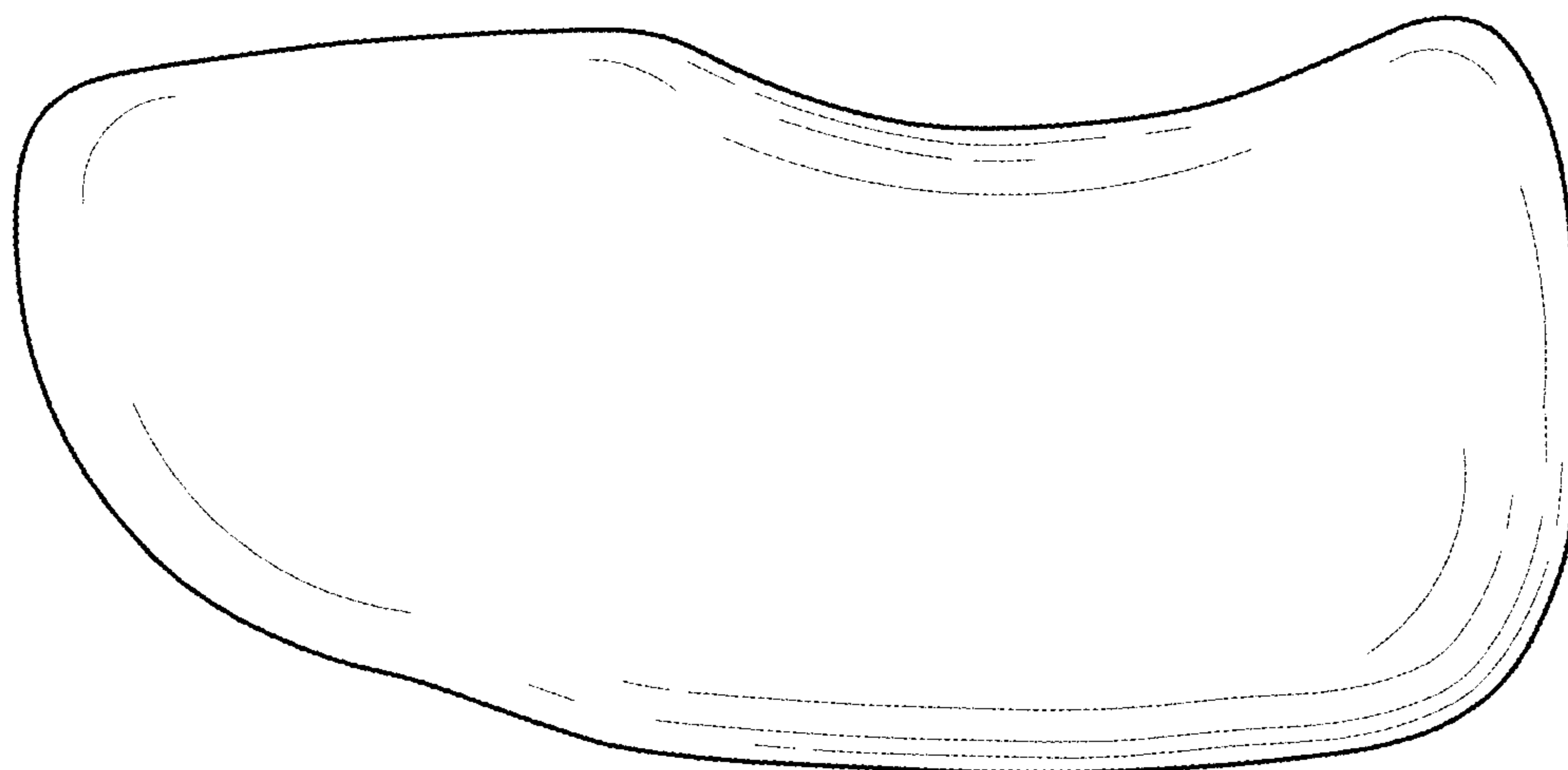

FIG. 5

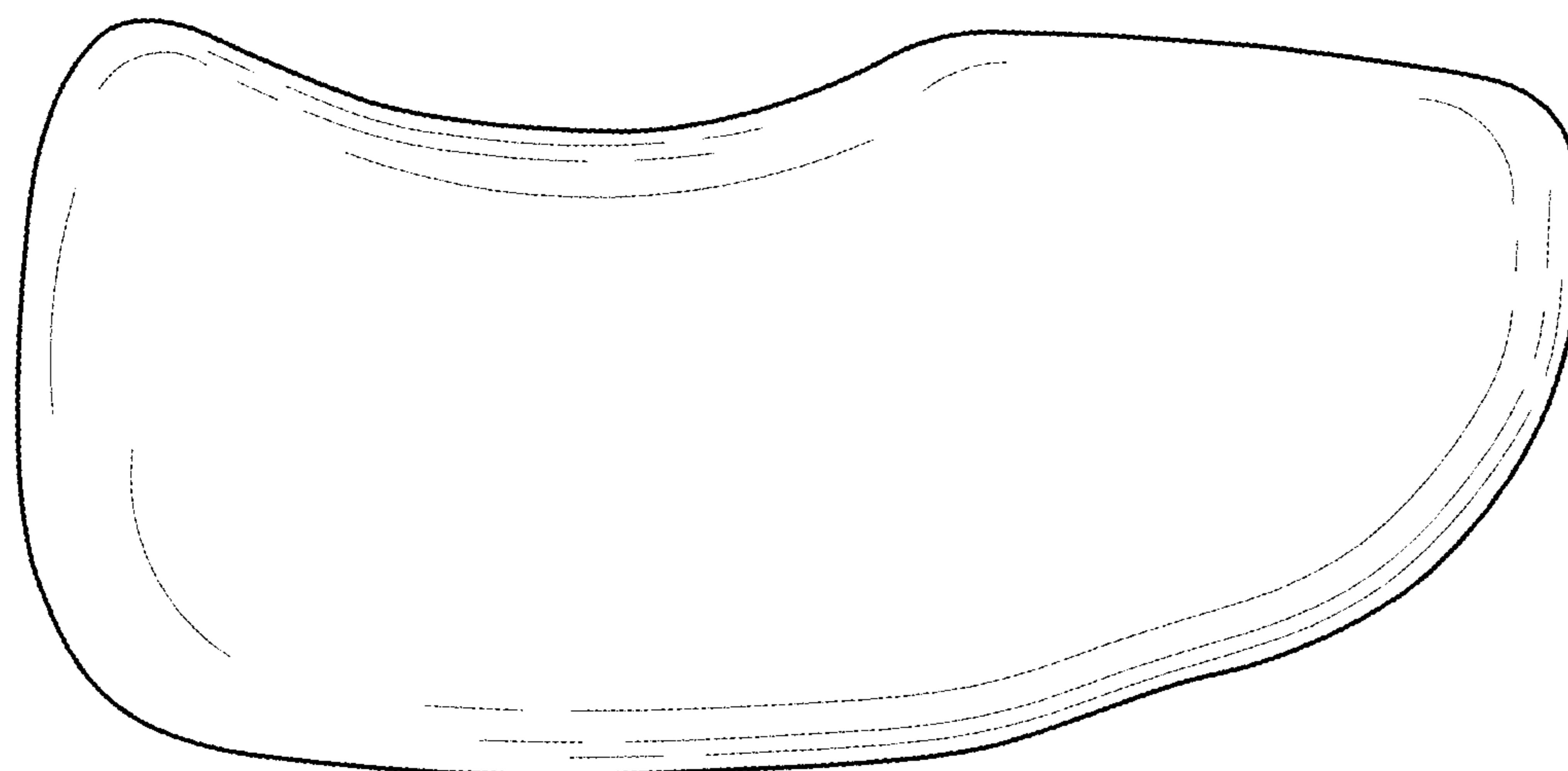

FIG. 6

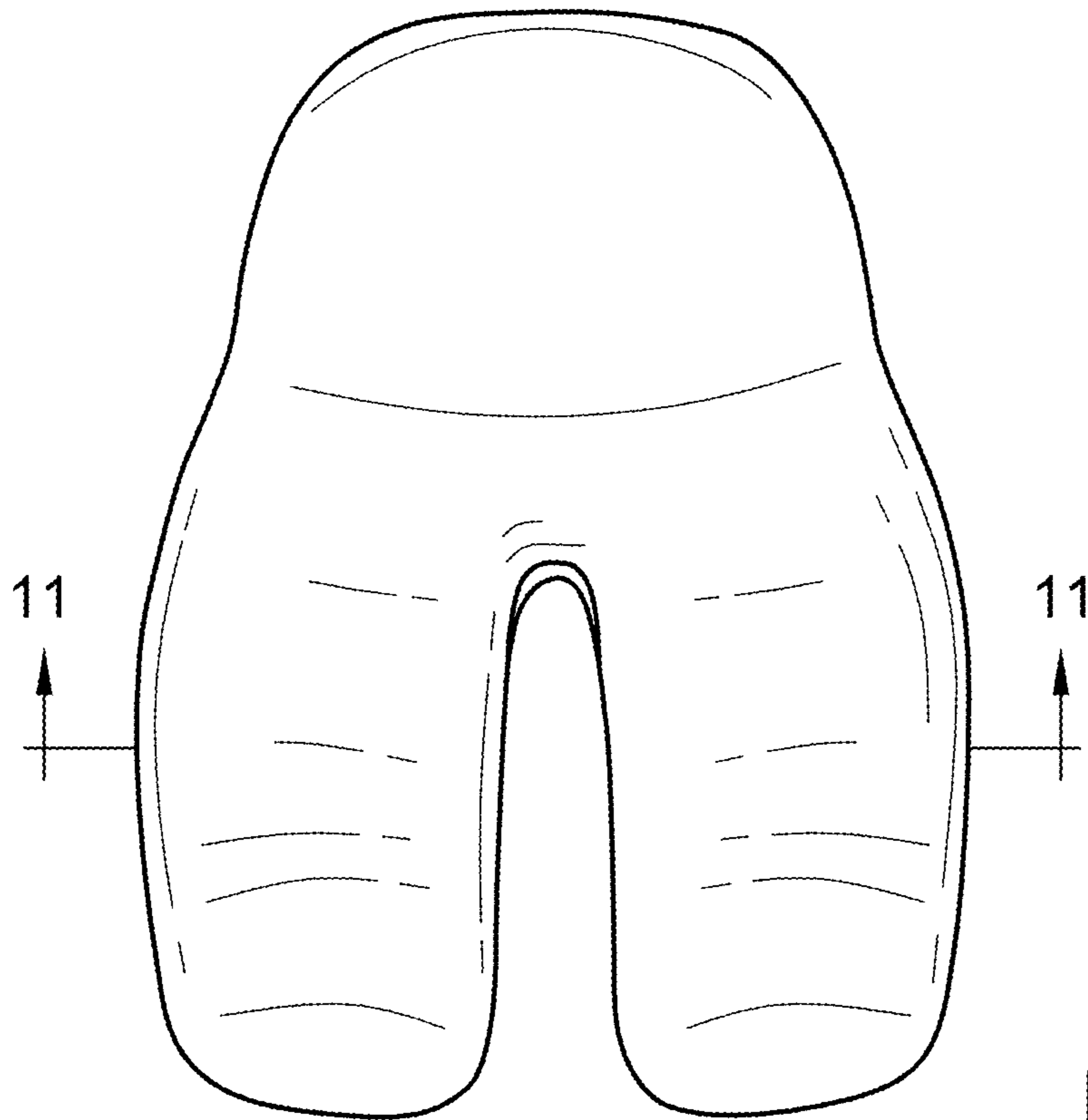

FIG. 7

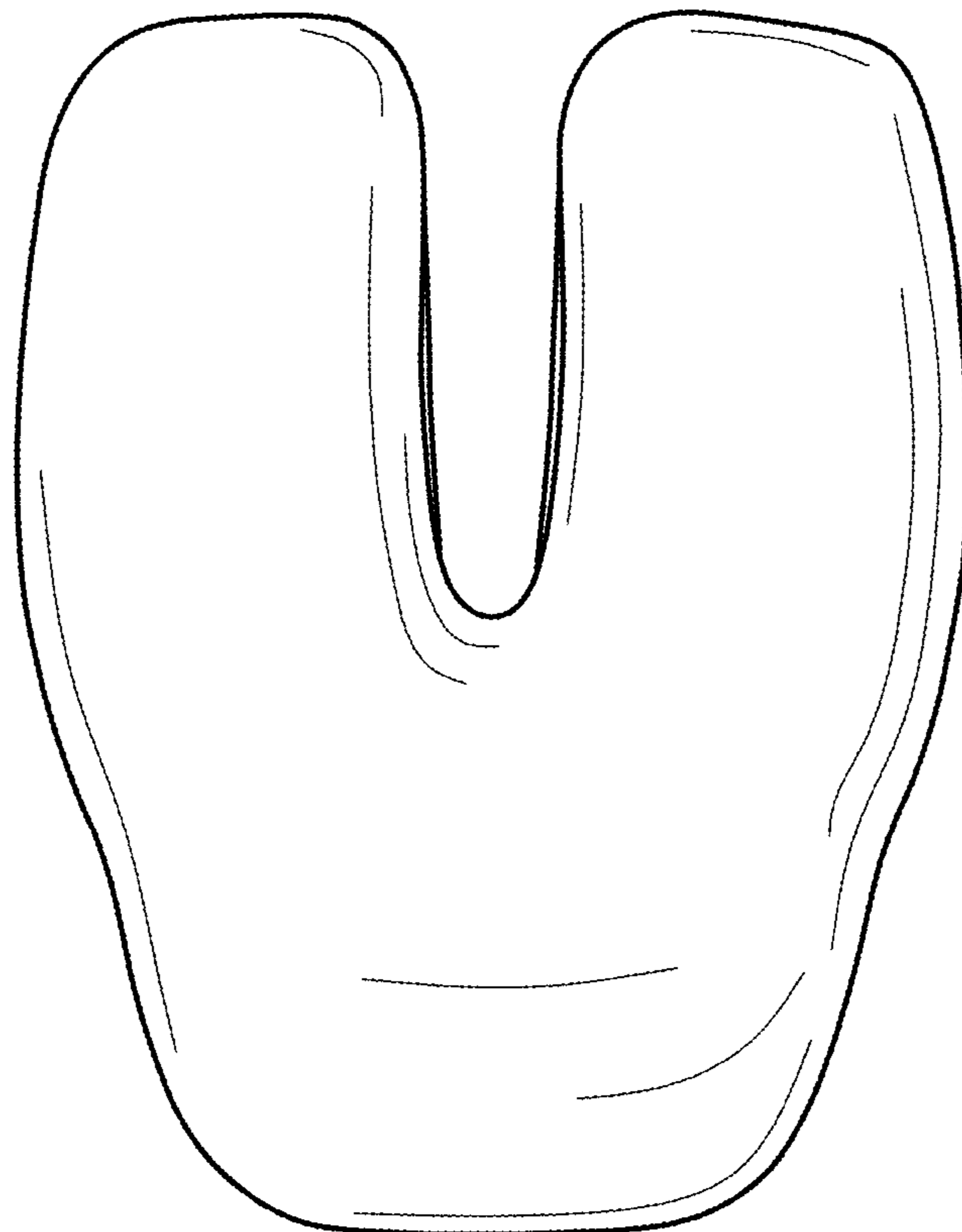

FIG. 8

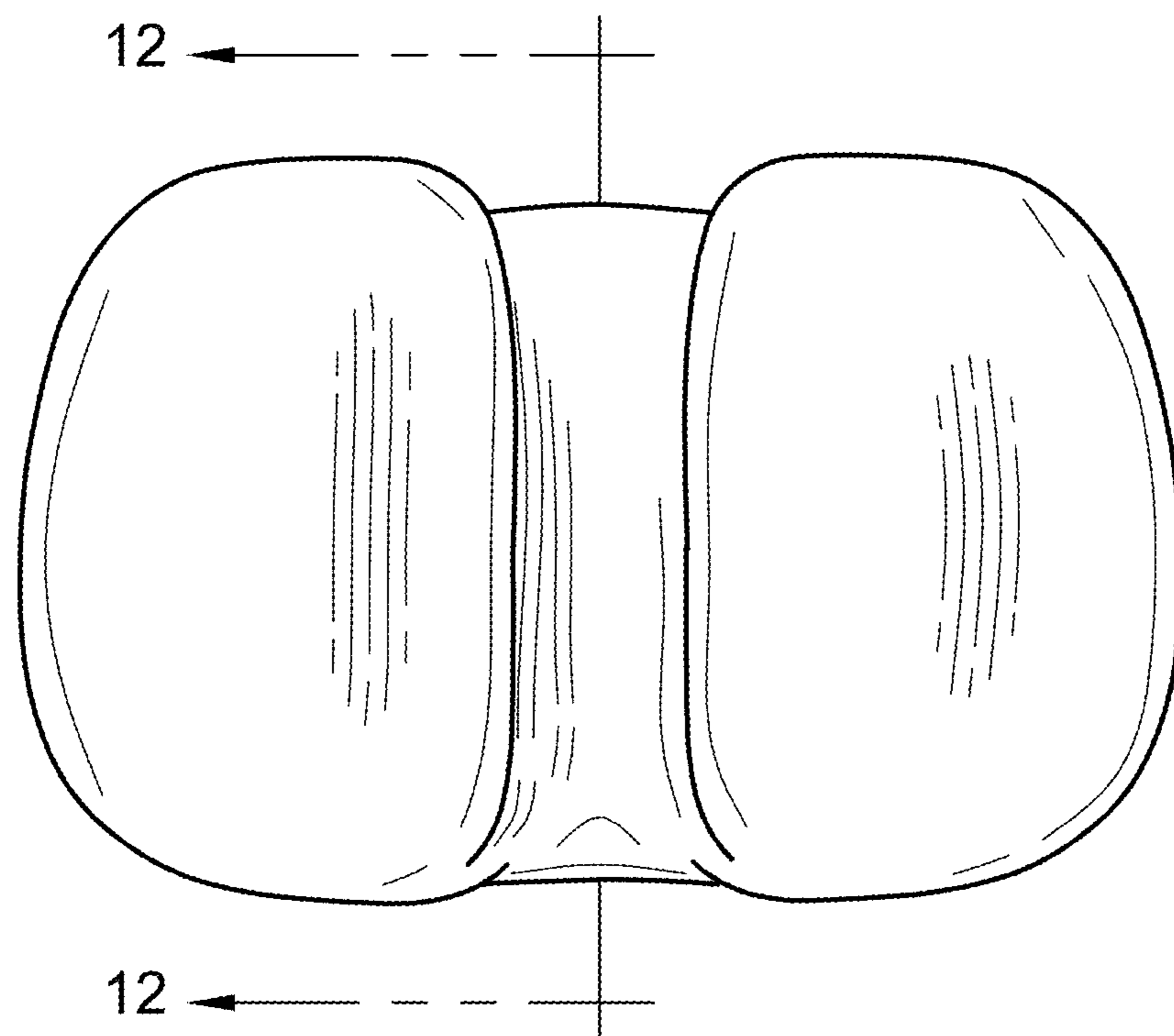

FIG. 9

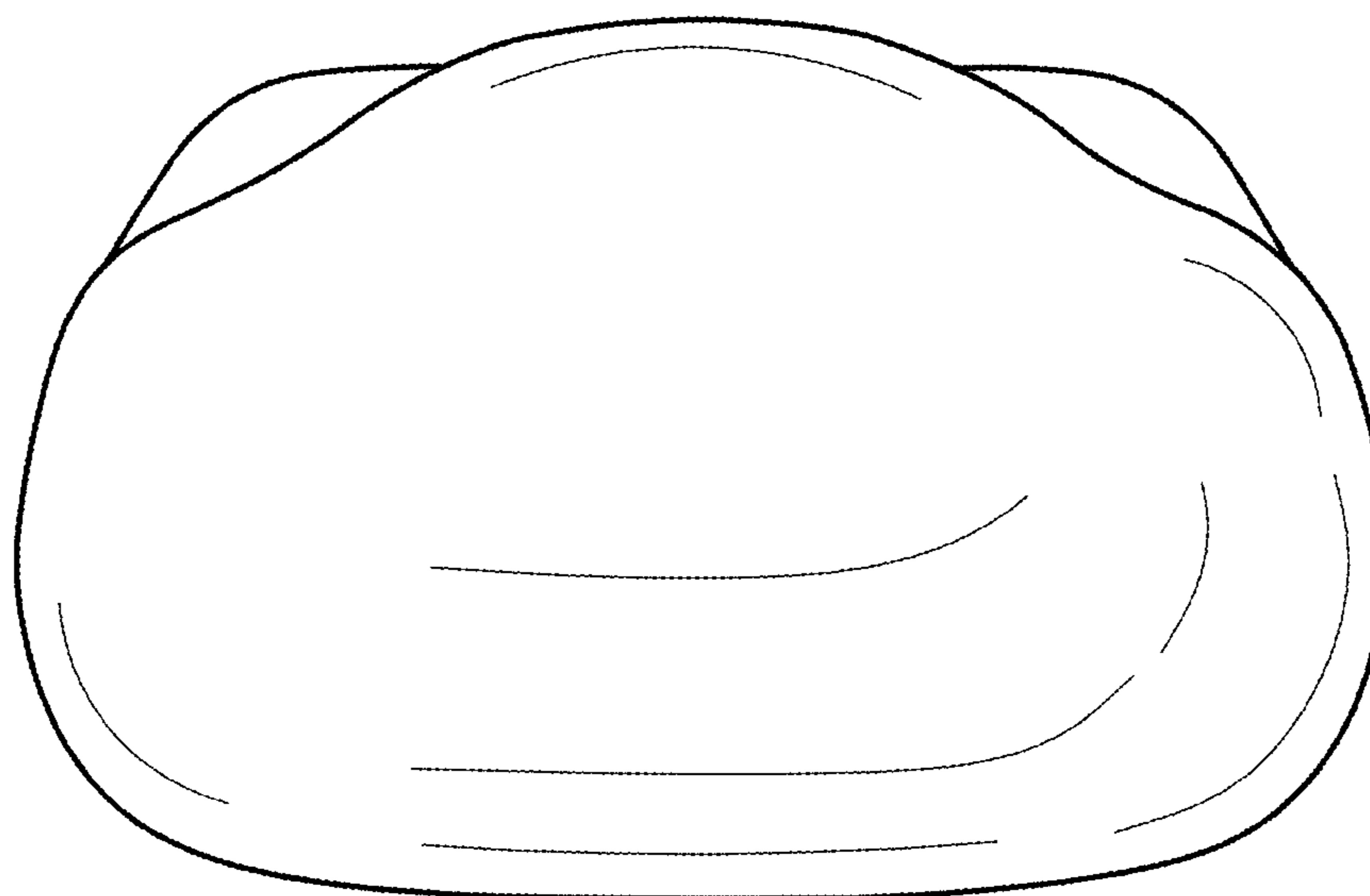

FIG. 10

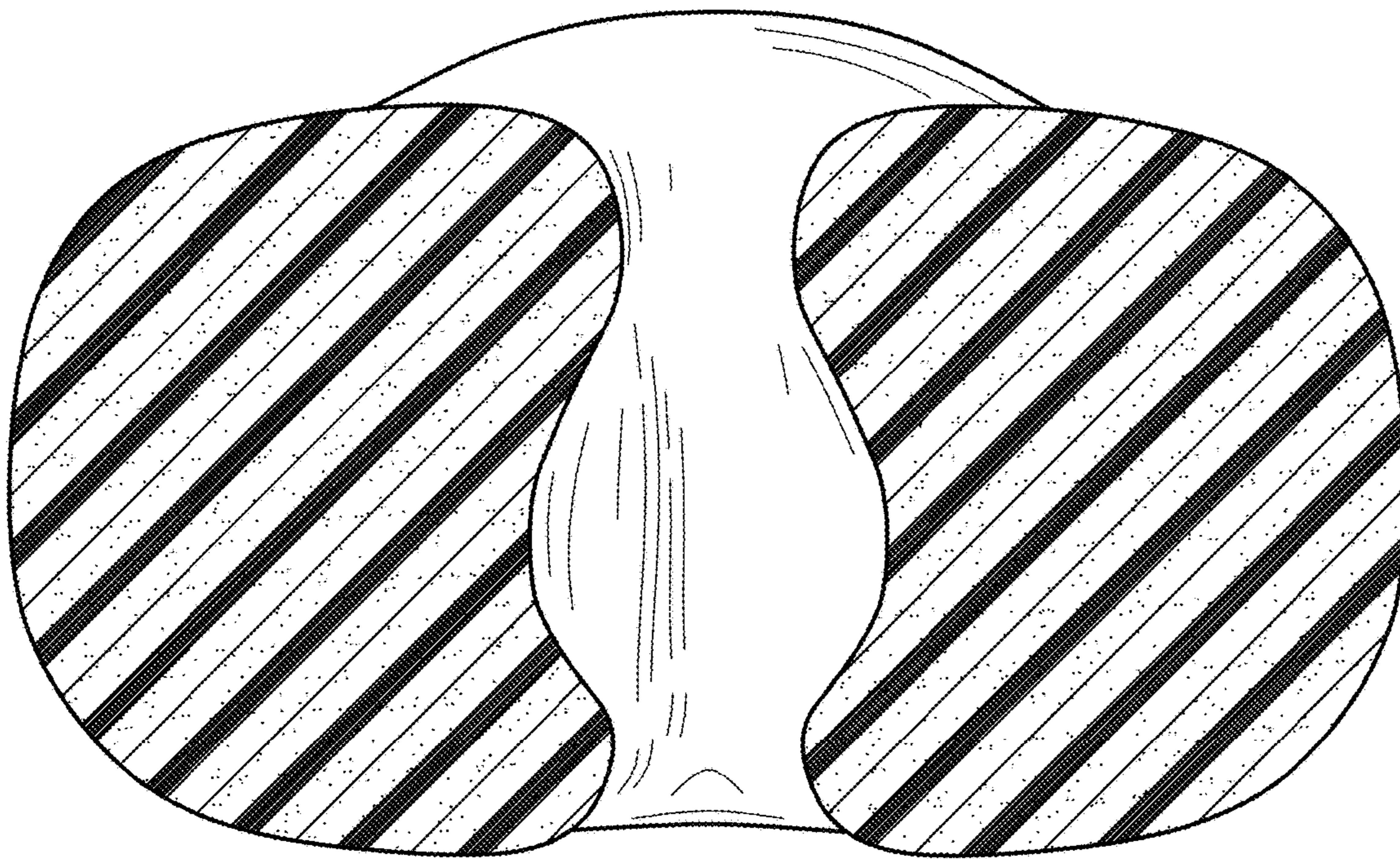

FIG. 11



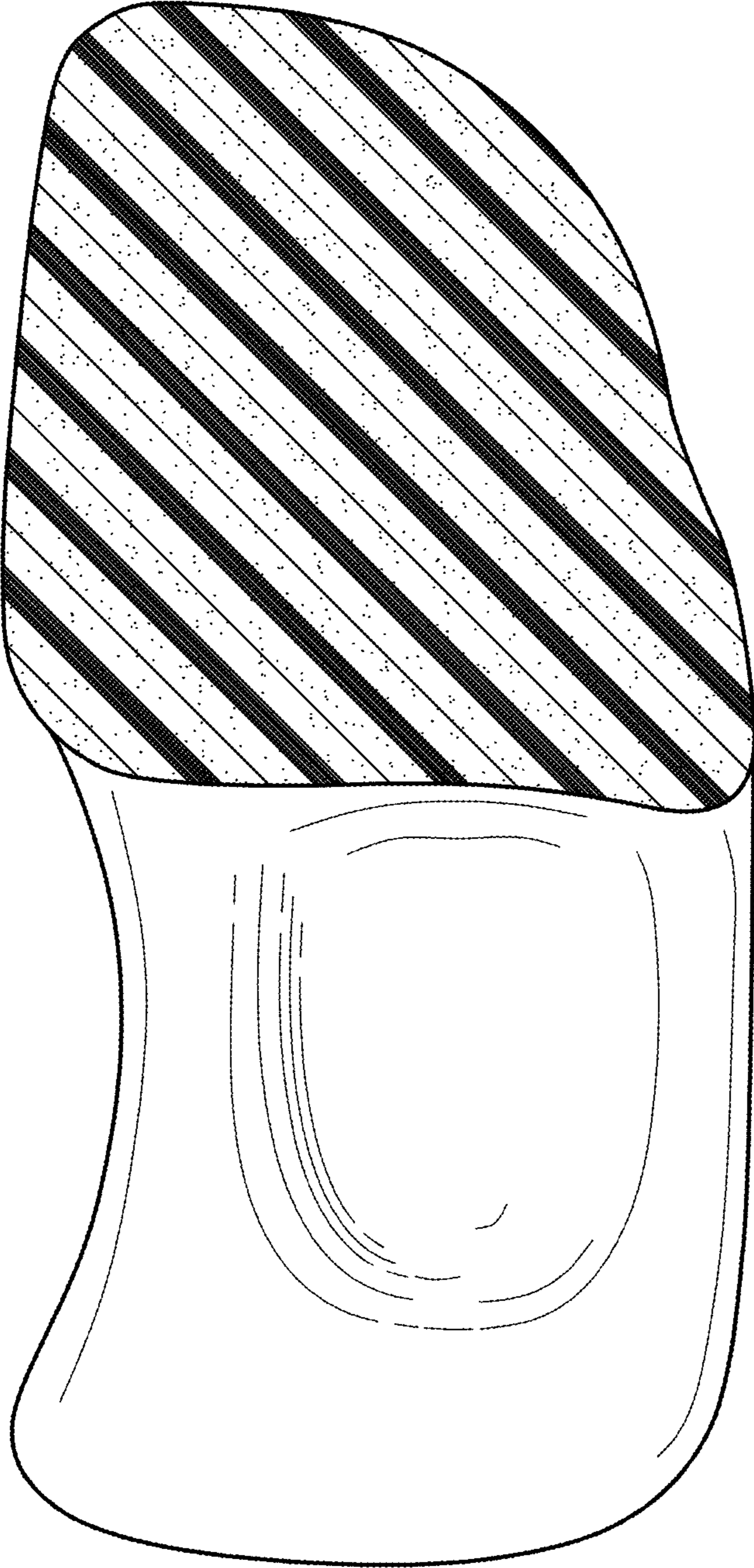

FIG. 12