



US00D802224S

(12) **United States Design Patent**  
**Newman et al.**

(10) **Patent No.:** **US D802,224 S**  
(45) **Date of Patent:** **\*\* Nov. 7, 2017**

(54) **HEADGEAR**  
(71) Applicant: **Cascade Maverik Lacrosse, LLC**,  
Exeter, NH (US)  
(72) Inventors: **Jesse Newman**, Liverpool, NY (US);  
**David Winthrop Fream**, Newfields,  
NH (US); **Nicholas Colville**, Syracuse,  
NY (US)

(73) Assignee: **Cascade Maverik Lacrosse, LLC**,  
Exeter, NH (US)

(\*\*) Term: **15 Years**

(21) Appl. No.: **29/574,224**

(22) Filed: **Aug. 12, 2016**

(51) **LOC (10) Cl.** ..... **29-02**

(52) **U.S. Cl.**  
USPC ..... **D29/122**

(58) **Field of Classification Search**  
USPC ..... D29/102–107, 122; 2/6.1–6.3, 6.5, 6.7,  
2/172, 175.1, 175.6, 175.7, 195.1, 209,  
2/410, 422–425, 455, 909, 918, 920;  
D2/891; D5/63; D24/190, 191;  
128/864, 866, 867  
CPC ..... A42B 3/00; A42B 3/163; A42B 3/166;  
A42B 3/16; A42B 3/18; A42B 3/20;  
A42B 3/22; A42B 3/221; A42B 3/228;  
A42B 3/066; A42B 3/06; A63B 71/10;  
A61F 11/008  
See application file for complete search history.

(56) **References Cited**

**U.S. PATENT DOCUMENTS**

6,202,223 B1 \* 3/2001 Chartrand ..... A42B 3/127  
2/410  
D557,463 S \* 12/2007 Brown ..... D29/105

D597,260 S \* 7/2009 Brace ..... D29/122  
D603,099 S \* 10/2009 Bologna ..... D29/106  
D603,100 S \* 10/2009 Bologna ..... D29/106  
D617,956 S \* 6/2010 Taylor ..... D29/122  
D618,857 S \* 6/2010 Durocher ..... D29/102  
7,908,678 B2 \* 3/2011 Brine, III ..... A42B 3/12  
2/410  
8,182,909 B2 \* 5/2012 Schneider ..... C08G 18/10  
106/287.26  
D703,387 S \* 4/2014 Janisse ..... D29/105  
D704,897 S \* 5/2014 Emrich ..... D29/108

\* cited by examiner

*Primary Examiner* — Randall Gholson

(74) *Attorney, Agent, or Firm* — Wolf, Greenfield &  
Sacks, P.C.

(57) **CLAIM**

The ornamental design for headgear, as shown and  
described.

**DESCRIPTION**

FIG. 1 is a top, front, left side perspective view of headgear  
showing our new design;  
FIG. 2 is a front elevation view thereof;  
FIG. 3 is a rear elevation view thereof;  
FIG. 4 is a left side elevation view thereof;  
FIG. 5 is an enlarged fragmentary side view of the portion  
shown within the circular area identified as 5 in FIG. 4;  
FIG. 6 is a right side elevation view thereof;  
FIG. 7 is a top plan view thereof; and,  
FIG. 8 is a bottom plan view thereof.  
The broken lines represent portions of the headgear that  
form no part of the claimed design.

**1 Claim, 8 Drawing Sheets**

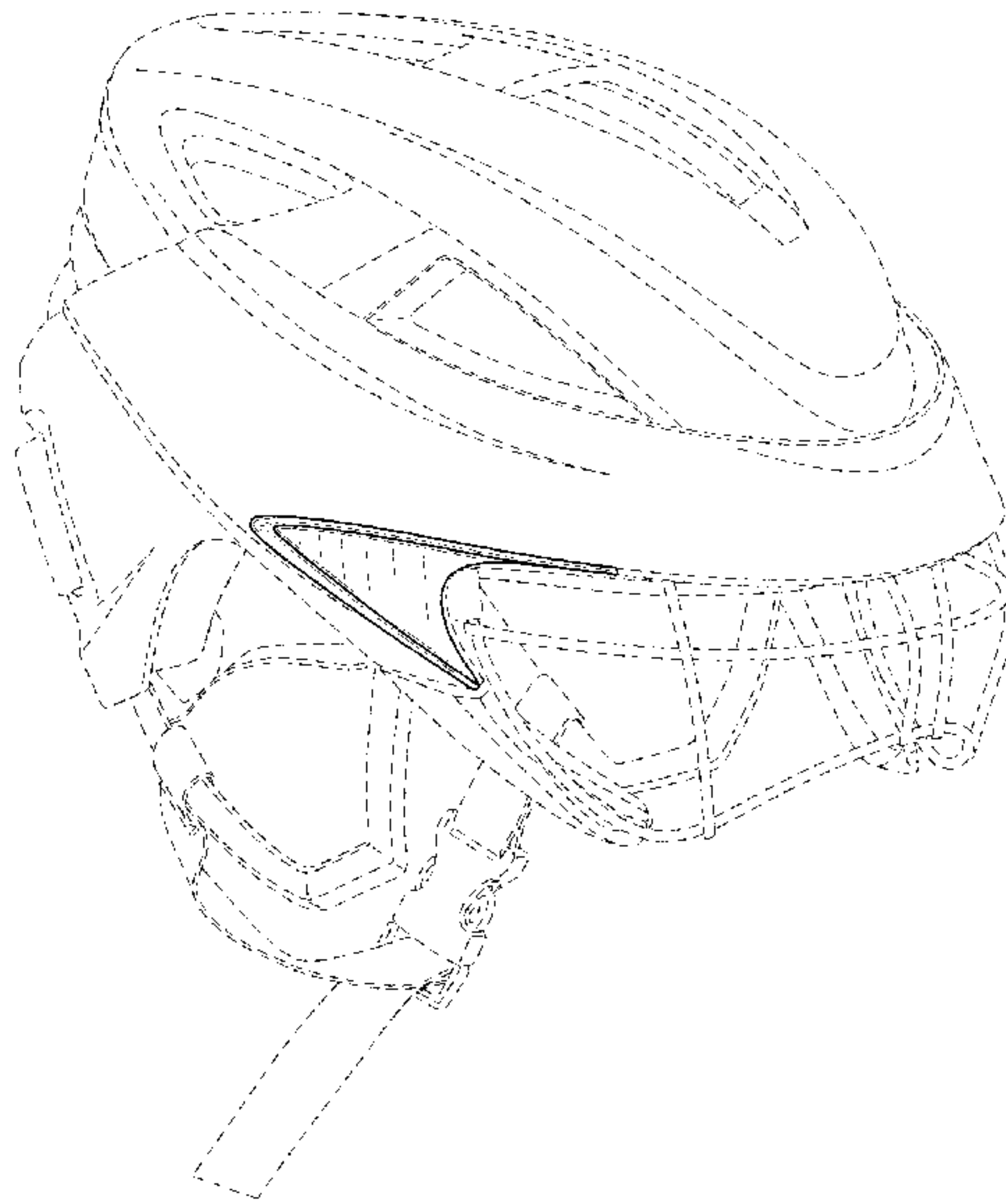

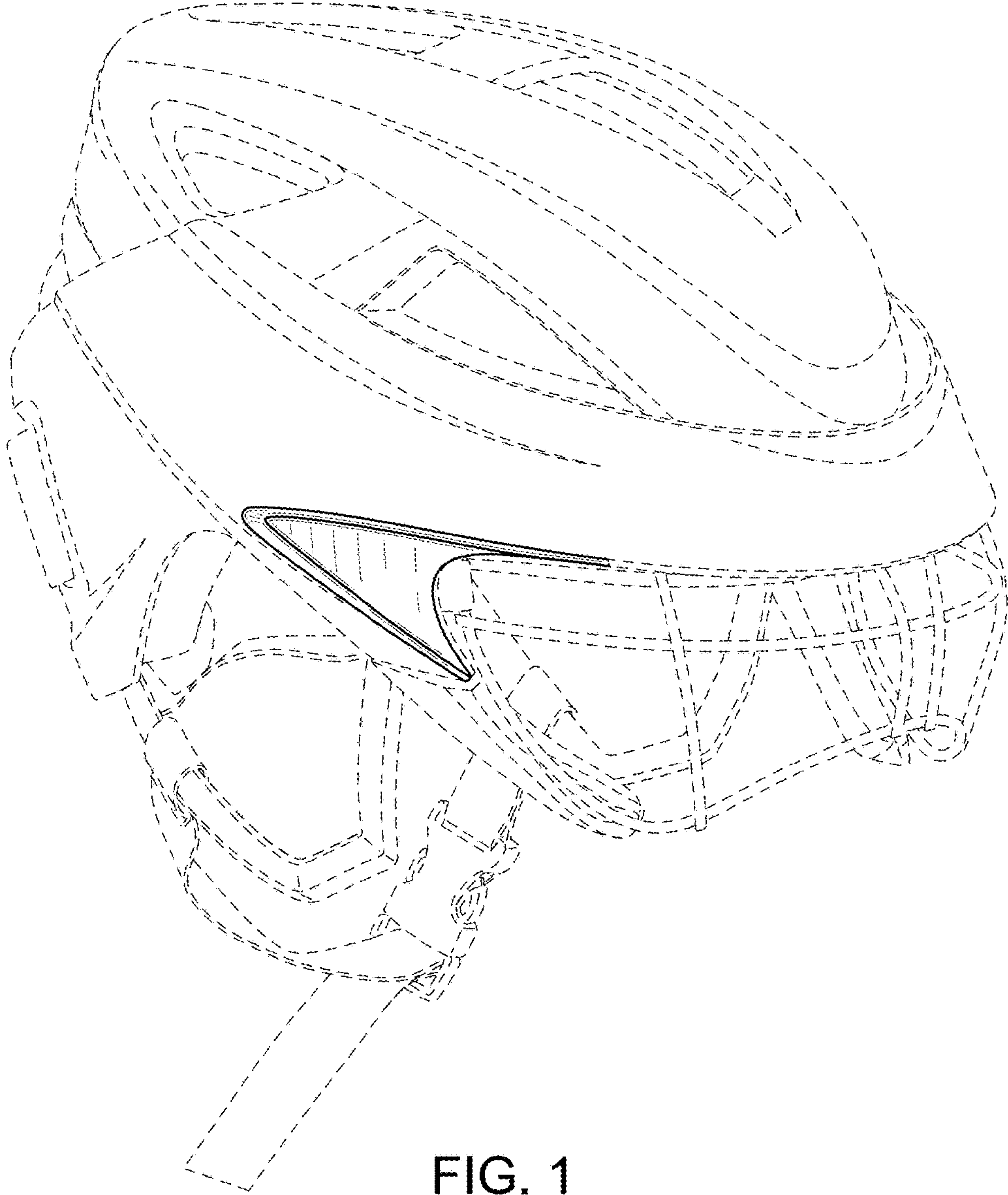

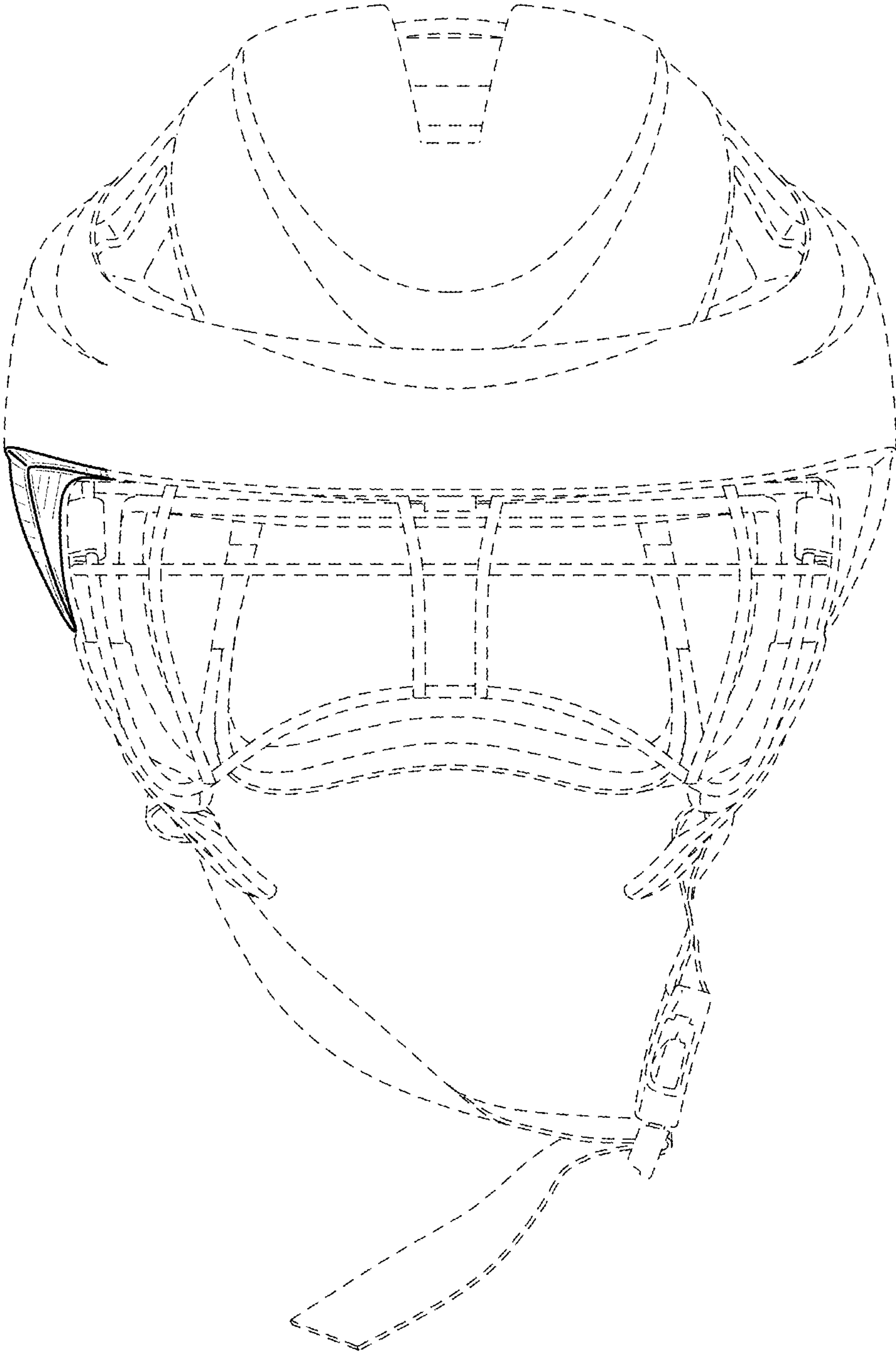

FIG. 2

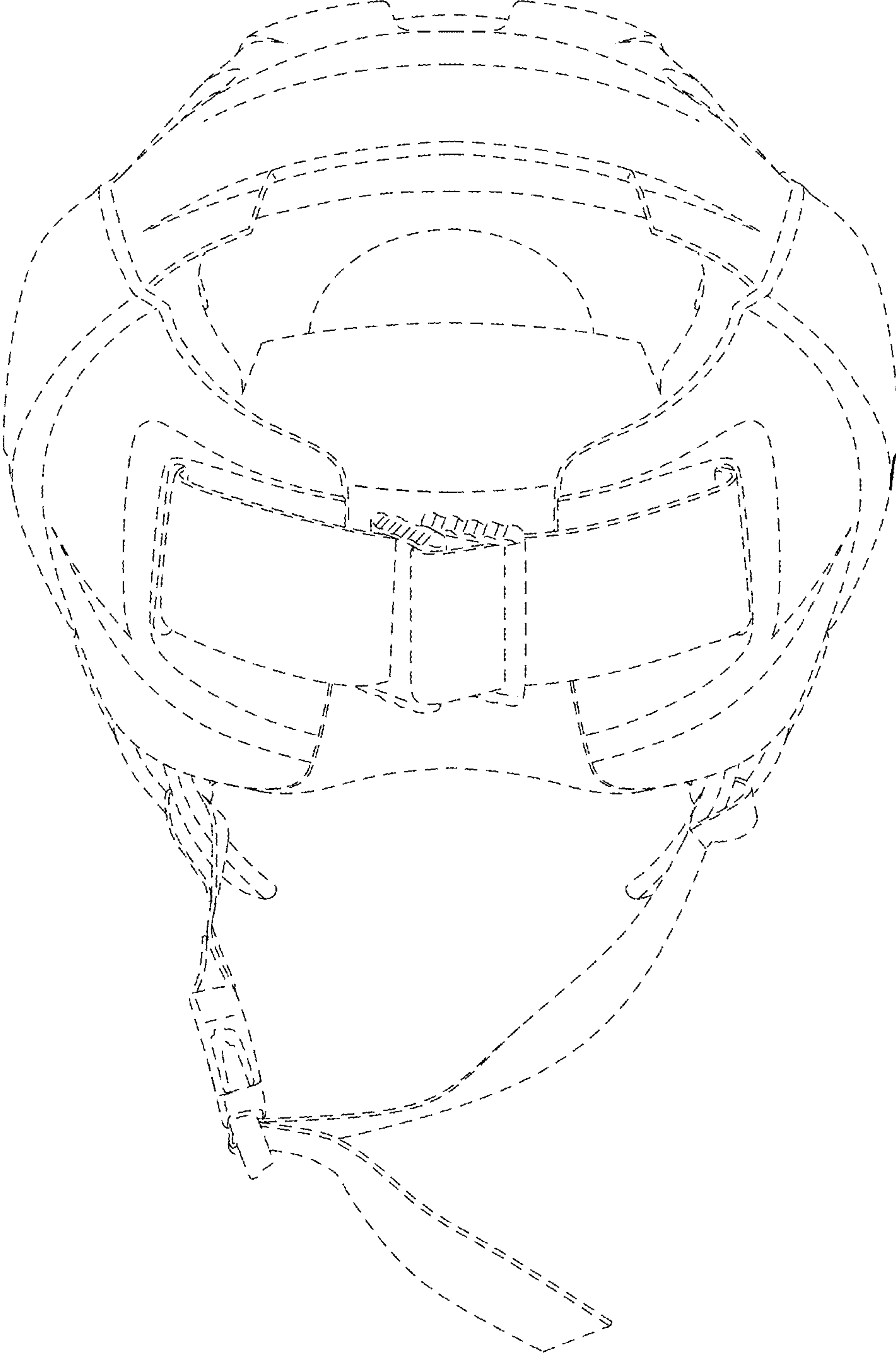

FIG. 3



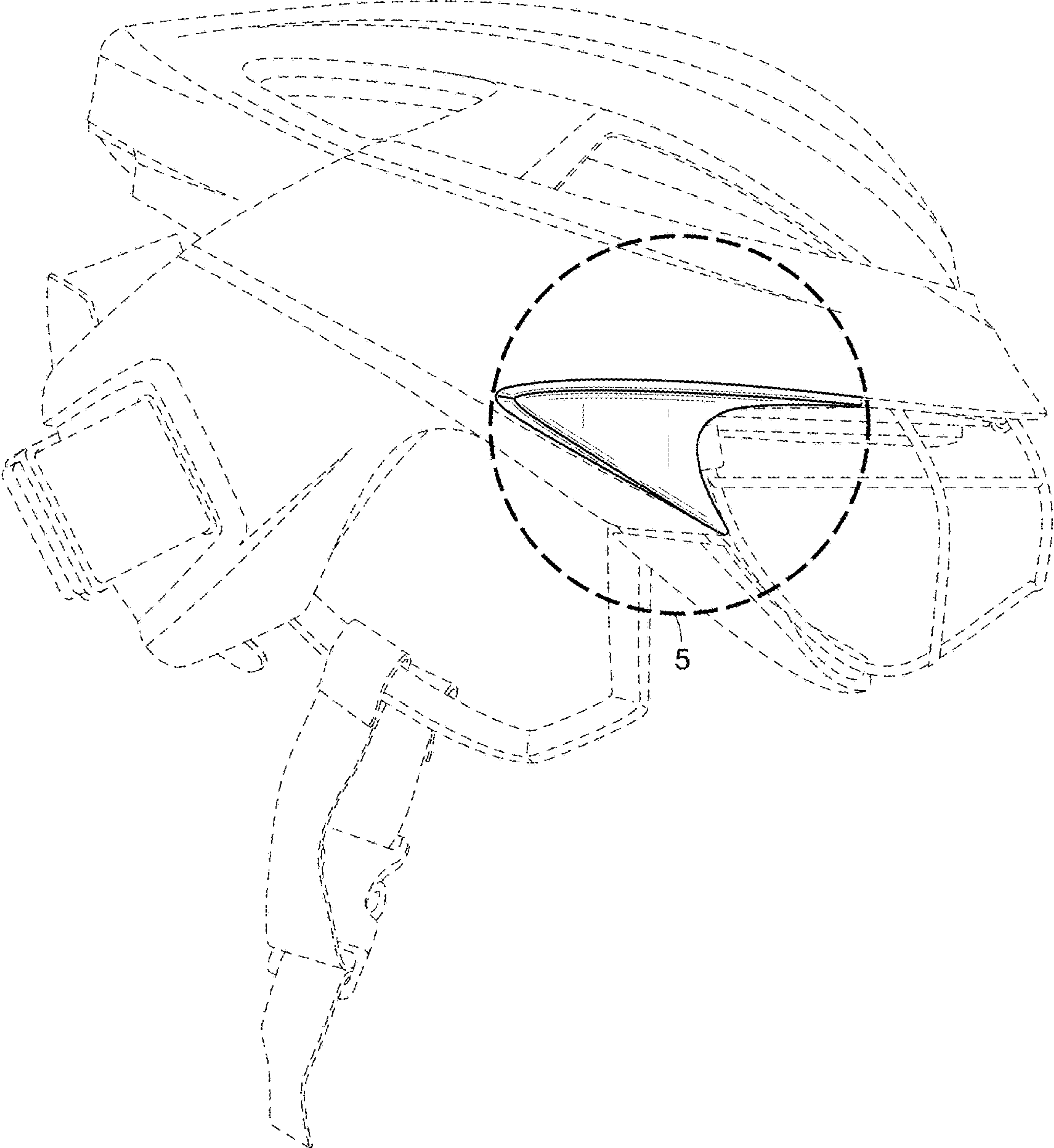

FIG. 4

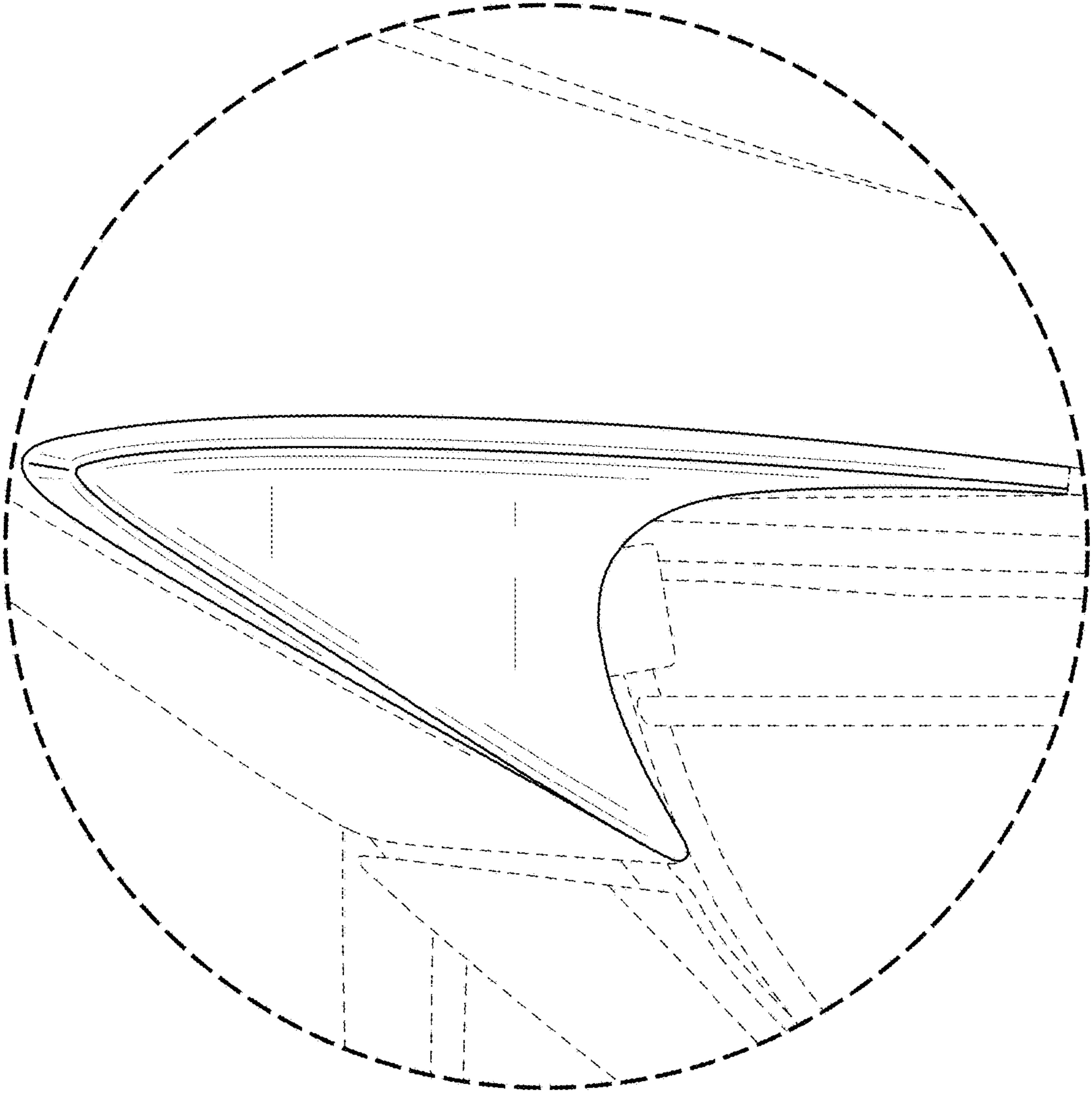

FIG. 5

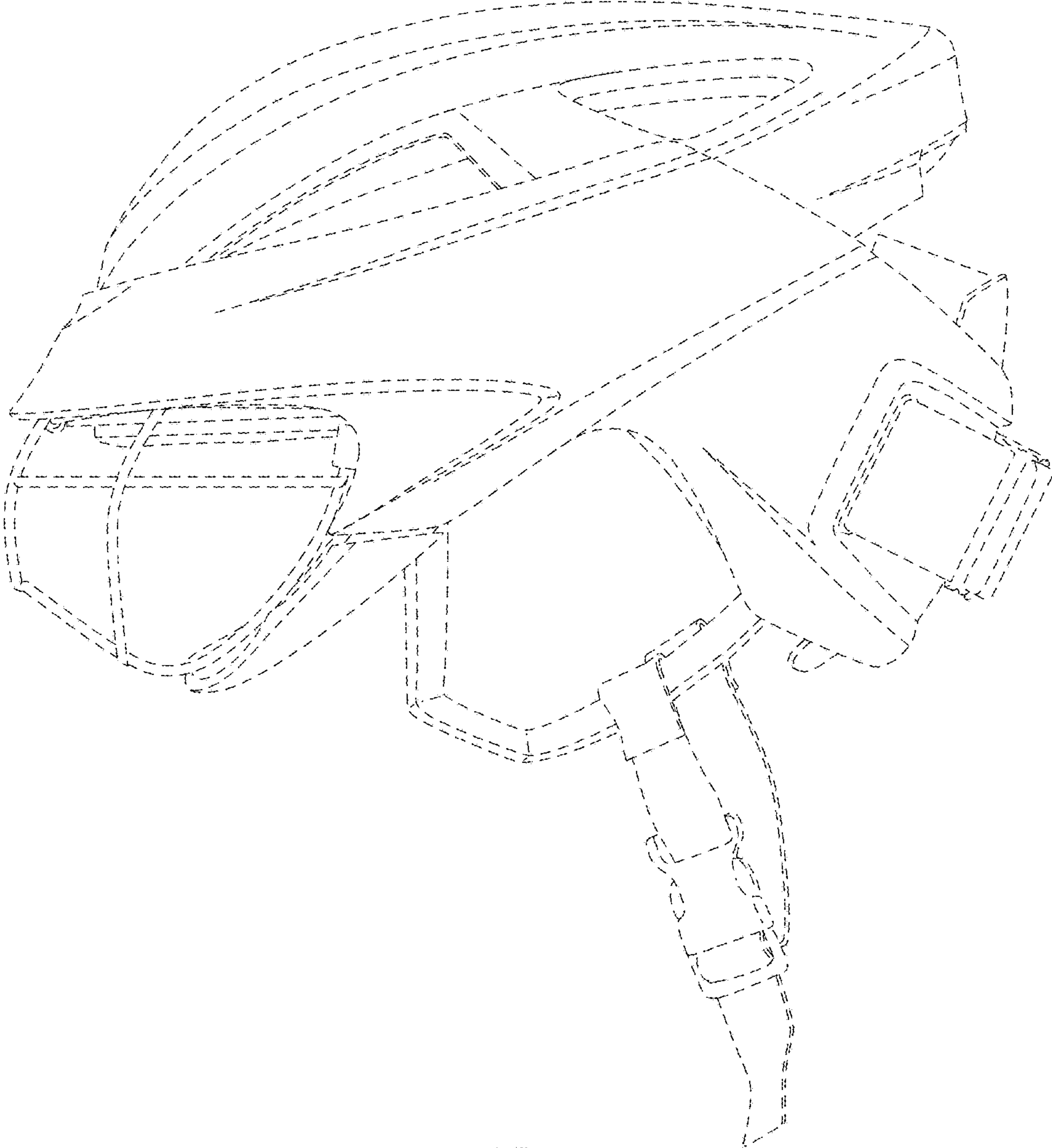

FIG. 6

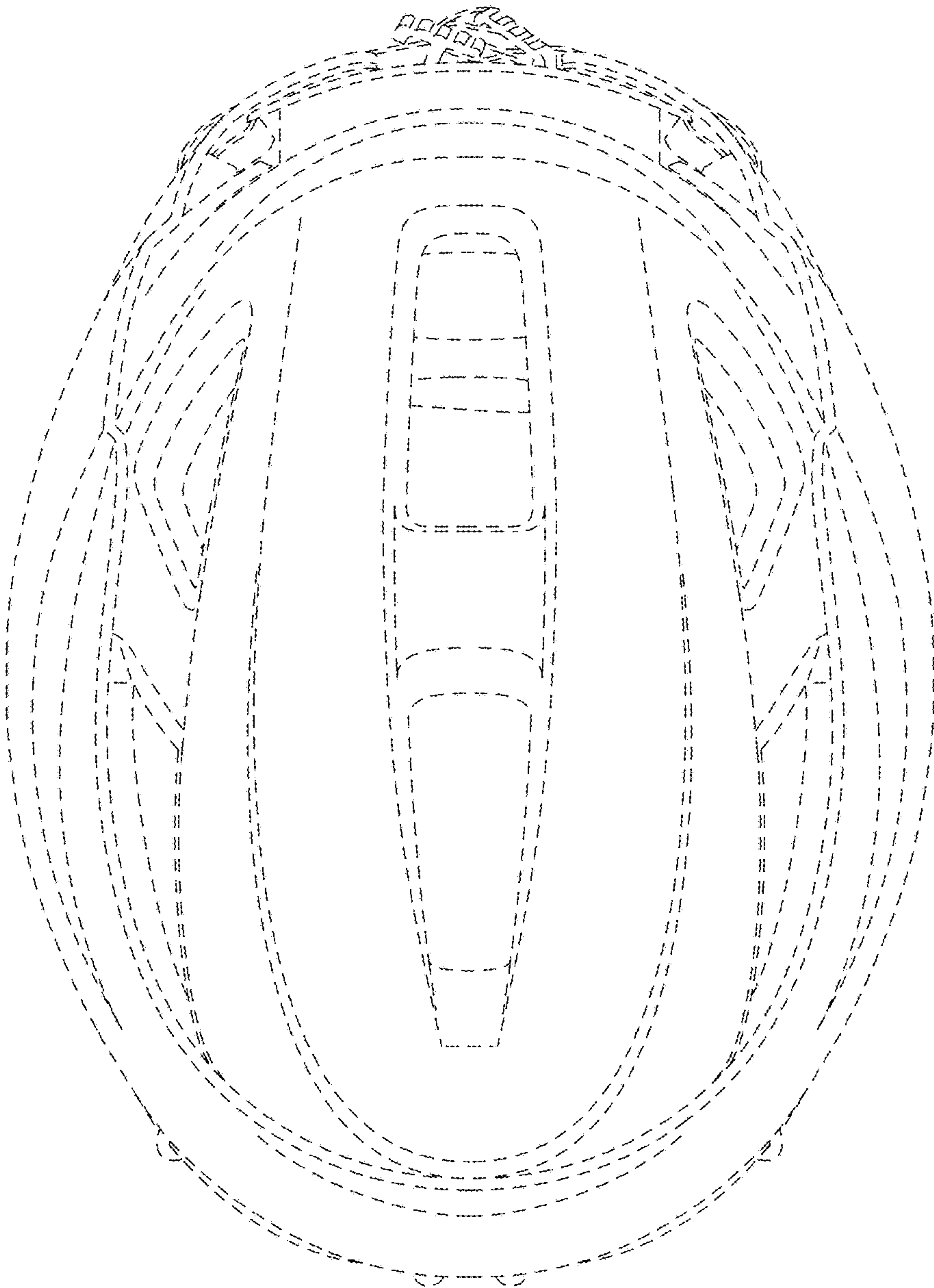

FIG. 7



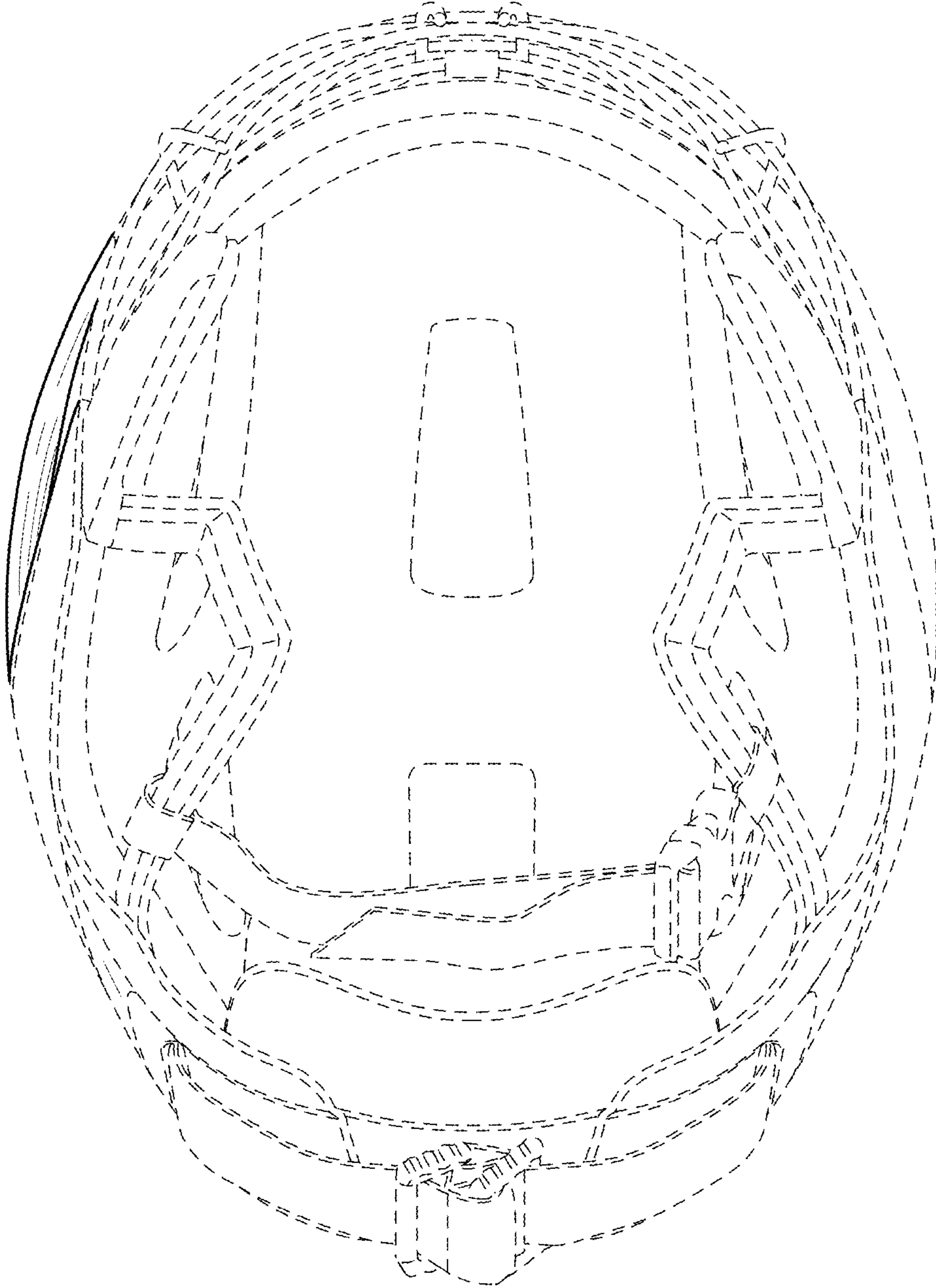

FIG. 8