



US00D802221S

(12) **United States Design Patent**
Piotrowski

(10) **Patent No.:** **US D802,221 S**

(45) **Date of Patent:** **** Nov. 7, 2017**

- (54) **CUT RESISTANT GLOVE WITH ELASTOMERIC STRAPS**
- (71) Applicant: **US Mesh, Inc.**, Orchard Park, NY (US)
- (72) Inventor: **Matthew Piotrowski**, Hamburg, NY (US)
- (73) Assignee: **US MESH LLC**, Hamburg, NY (US)
- (**) Term: **14 Years**
- (21) Appl. No.: **29/509,754**
- (22) Filed: **Nov. 20, 2014**
- (51) **LOC (10) Cl.** **02-06**
- (52) **U.S. Cl.**
USPC **D29/117.1**
- (58) **Field of Classification Search**
USPC D2/610, 616, 617, 621, 623; D29/113, D29/114, 117.1, 123; 2/16, 17, 159, 160, 2/161.1, 161.3, 161.4, 161.6, 161.8, 162, 2/163, 167, 168
CPC A41D 13/08; A41D 13/081; A41D 19/00; A41D 19/0034; A41D 19/0044; A41D 19/0048; A41D 19/0082; A41D 19/015; A41D 19/01502; A41D 19/01511; A41D 19/01529; A41D 19/1558; A41D 2300/00; A41F 1/06
See application file for complete search history.

4,330,120	A *	5/1982	Netti	A63B 21/065	2/160
4,470,251	A	9/1984	Bettcher		
4,471,495	A	9/1984	Kruse et al.		
D278,455	S *	4/1985	Nosek	D21/683	
4,779,290	A *	10/1988	Welch	A41D 19/0058	2/161.6
4,843,650	A	7/1989	Kangas et al.		
5,054,126	A	10/1991	Rivkin		
D348,141	S	6/1994	Lars-Jos, Jr. et al.		
D354,137	S *	1/1995	Neal	D24/190	
5,452,478	A *	9/1995	Rombach	A41D 19/0048	2/159
5,774,897	A	7/1998	Hochmuth		
5,894,602	A	4/1999	Smith et al.		
6,016,648	A	1/2000	Bettcher et al.		
6,061,833	A	5/2000	Smith et al.		
6,076,190	A *	6/2000	Besson	A41F 1/06	2/16
6,161,400	A	12/2000	Hummel		
6,351,932	B1	3/2002	Hummel		
6,438,759	B1	8/2002	Jaunault et al.		
6,442,761	B1	9/2002	Huang		
7,062,792	B2	6/2006	Jaunault et al.		
7,188,373	B2	3/2007	Jaunault et al.		
7,237,272	B2 *	7/2007	Botcher	A41D 19/01511	2/161.6
7,934,396	B2	5/2011	Zhu		
8,002,222	B2	8/2011	Jaunault et al.		
D651,358	S *	12/2011	Bulan	D29/117.1	
D668,820	S *	10/2012	Shamis	D29/120.1	
8,322,167	B2	12/2012	Dias et al.		
D710,548	S *	8/2014	Salzman	D29/117.1	
D712,098	S *	8/2014	Salzman	D29/117.1	
D737,525	S *	8/2015	Piotrowski	D29/117.1	
D741,551	S *	10/2015	Piotrowski	D29/117.1	
2003/0196247	A1 *	10/2003	Hellriegel	B25J 21/02	2/159
2003/0233695	A1 *	12/2003	Golde	A41D 19/015	2/161.1
2004/0064865	A1	4/2004	Jaunault et al.		
2004/0181848	A1	9/2004	Jaunault et al.		
2009/0210992	A1 *	8/2009	Duhatschek	A41D 19/01511	2/162
2011/0083250	A1 *	4/2011	Smith	A41D 19/0044	2/161.6
2015/0208745	A1 *	7/2015	Duhatschek	A41D 19/01511	2/463

(56) **References Cited**

U.S. PATENT DOCUMENTS

RE13,524	E	2/1913	Chaddock et al.		
1,205,229	A *	11/1916	Linden	A41D 19/01547	2/161.8
1,339,129	A	5/1920	Oathout		
D95,467	S	4/1935	Strauss		
2,074,390	A *	3/1937	Green	A41D 19/015	2/16
D128,678	S *	8/1941	Nathan	D2/619	
2,559,788	A	7/1951	Patterson, Jr.		
D184,255	S	1/1959	Higler		
D235,175	S *	5/1975	Berger	D29/117.1	

FOREIGN PATENT DOCUMENTS

WO	2003065832	8/2003
----	------------	--------

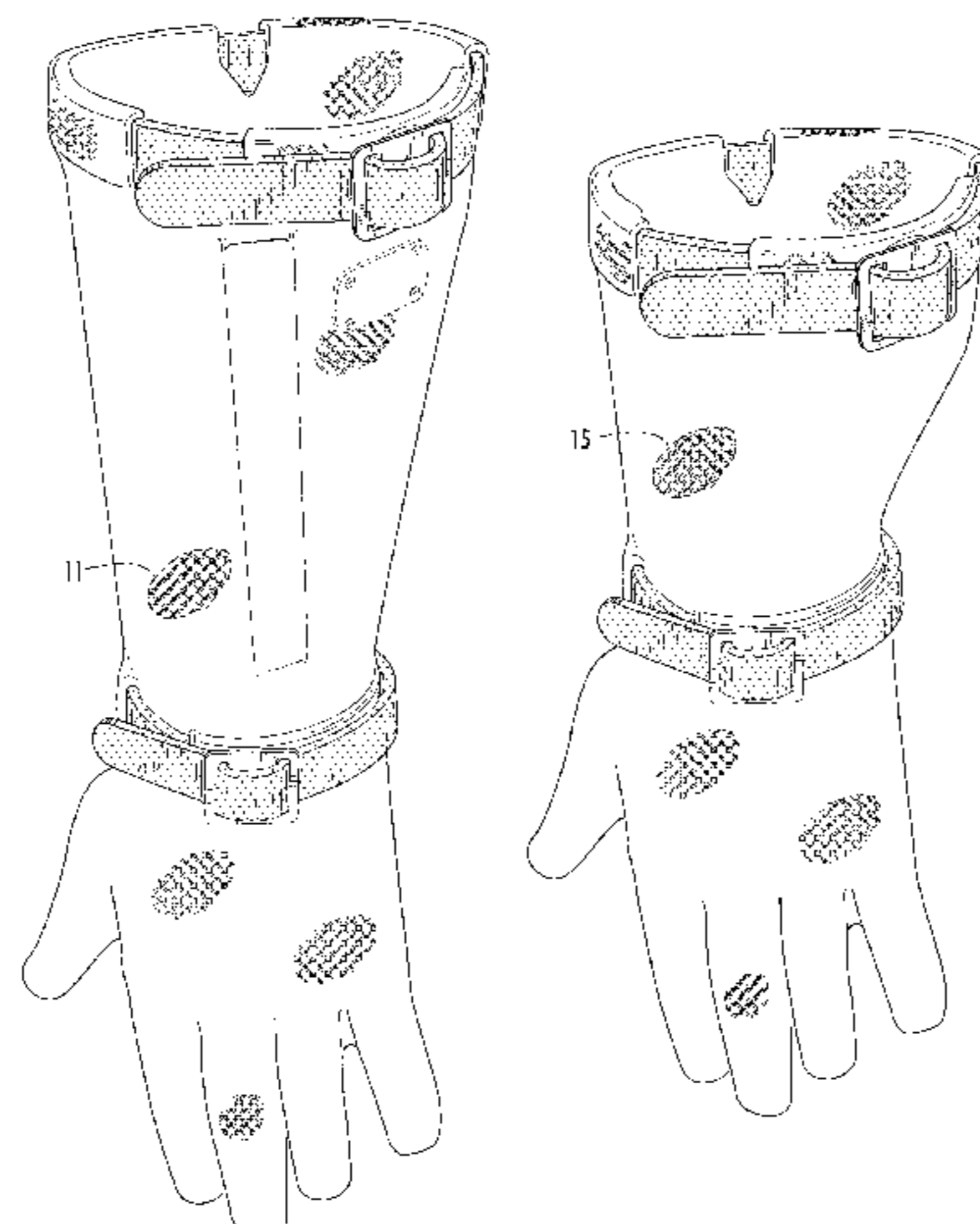

OTHER PUBLICATIONS

“Stainless Steel Mesh Glove Elbow Length,” available for sale on-line. Wayback Machine crawl back publication date: Jun. 29, 2011. Retrieved from the Internet on Jul. 11, 2016. URL: <https://web.archive.org/web/20110629153150/http://www.envirosafetyproducts.com/stainless-steel-mesh-glove-elbowlength.html>. (3 pages).*

“Long-Sleeve Anti-Cut Butcher Metal Mesh Glove/Chain Mail Butcher Glove,” available for sale on-line. Publication date unknown. Retrieved from Internet Jul. 11, 2016. URL: <http://retonwiremesh.en.made-inchina.com/productimage/ZKDJRfdPHIWn-2f1j00PSATLVZILjqc/China-Long-Sleeve-Anti-Cut-Butcher-Metal-Mesh-Glove-Chain-Mail-Butcher-Glove.html>. (3 pages).*

“5 Finger Metal Mesh, Extended Cuff Glove—Silicone Strap—USM-1305-SB,” available for sale on-line. Publication date unknown. Retrieved from the Internet on Jul. 11, 2016. URL: <http://usmesh.com/portfolio/5-finger-metal-mesh-extended-cuff-glove-silicone-strap/gallery/extended-cuff/>. (3 pages).*

Euroflex, “5-finger with 21 cm cuff”, accessed May 24, 2015, <http://www.euroflex-safety.de/en/Produkte/Stehschutzhandschuhe-EUROFLEX-wave-comfort-5-Finger-mit-21-cm-Stulpe/>, [unknown publication date].

Euroflex, “5-finger with 8 cm cuff”, accessed May 24, 2015, <http://www.euroflex-safety.de/en/Produkte/Stehschutzhandschuhe-EUROFLEX-wave-comfort-5-Finger-mit-8-cm-Stulpe/>, [unknown publication date].

Honeywell, “Whiting+Davis_5902 DP_Technical Data”, accessed May 24, 2015, http://www.honeywellsafety.com/Supplementary/Documents_and_Downloads/Gloves/Metal_Mesh/29187/1033.aspx, [unknown publication date].

Honeywell, “Whiting+Davis_525 SC_Technical Data”, accessed May 24, 2015, http://www.honeywellsafety.com/Supplementary/Documents_and_Downloads/Gloves/Metal_Mesh/29186/1033.aspx, [unknown publication date].

Niroflex, “Niroflex2000 Ultra-Hygienic Product Line”, accessed May 24, 2015, <http://www.niroflex.com/>, [unknown publication date].

* cited by examiner

Primary Examiner — Karen E Eldridge Powers

Assistant Examiner — Jasmine Mlinarcik

(74) *Attorney, Agent, or Firm* — Hodgson Russ LLP

(57) CLAIM

The ornamental design for a cut resistant glove with elastomeric straps, as shown and described.

DESCRIPTION

FIG. 1 is a perspective view of a cut resistant glove with elastomeric straps showing my new design, the glove having a plurality of vertical stiffeners and snap-fastened elastomeric straps (further depicted in FIGS. 20-29), and with the elastomeric straps being shown in a relaxed state;

FIG. 2 is a front elevational view thereof;

FIG. 3 is a rear elevational view thereof;

FIG. 4 is a right side elevational view thereof;

FIG. 5 is a left side elevational view thereof;

FIG. 6 is a bottom plan view thereof;

FIG. 7 is a top plan view thereof;

FIG. 8 is a front elevational view thereof showing the elastomeric straps in a stretched state;

FIG. 9 is a top plan view thereof;

FIG. 10 is a bottom plan view thereof;

FIG. 11 is an enlarged view of the mesh taken from FIG. 1;

FIG. 12 is a perspective view of a second embodiment of a cut resistant glove with elastomeric straps, the second embodiment being identical to the first embodiment except for having a lower cuff height and not including vertical stiffeners;

FIG. 13 is a front elevational view thereof;

FIG. 14 is a left elevational view thereof;

FIG. 15 is an enlarged view of the mesh taken from FIG. 12;

FIG. 16 is a perspective view of the embodiment of FIG. 12 shown with the buckle-fastened elastomeric straps further depicted in FIGS. 30-36;

FIG. 17 is a front elevational view thereof;

FIG. 18 is a left side elevational view thereof;

FIG. 19 is an enlarged view of the mesh taken from FIG. 16;

FIG. 20 is a perspective view of the snap-fastened elastomeric strap shown separately from a glove for ease of illustration, the elastomeric strap being in an unthreaded, snapped state;

FIG. 21 is a front elevational view thereof;

FIG. 22 is a rear elevational view thereof;

FIG. 23 is a bottom plan view thereof;

FIG. 24 is a top plan view thereof;

FIG. 25 is a right side elevational view thereof;

FIG. 26 is a left side elevational view thereof;

FIG. 27 is a top plan view thereof, the snap-fastened elastomeric strap being in a threaded, snapped state;

FIG. 28 is a left side elevational view thereof;

FIG. 29 is a right side elevational view thereof;

FIG. 30 is a perspective view of the buckle-fastened elastomeric strap shown separately from a glove for ease of illustration, the elastomeric strap being in an unthreaded state;

FIG. 31 is a front elevational view thereof;

FIG. 32 is a rear elevational view thereof;

FIG. 33 is a bottom elevational view thereof;

FIG. 34 is a top plan view thereof;

FIG. 35 is a right side elevational view thereof; and,

FIG. 36 is a left side elevational view thereof.

The broken lines in the drawings illustrate features of the article of manufacture that form no part of the claimed design. No claim is made to any feature located between the symbolic break boundary lines shown in FIGS. 17-21 and 27-31. The mesh, although shown intermittently in the drawings for ease of illustration, is understood to continue throughout the glove. The stippling shown in the drawings serve to indicate that the strap is made of a smooth, elastomeric material.

1 Claim, 24 Drawing Sheets

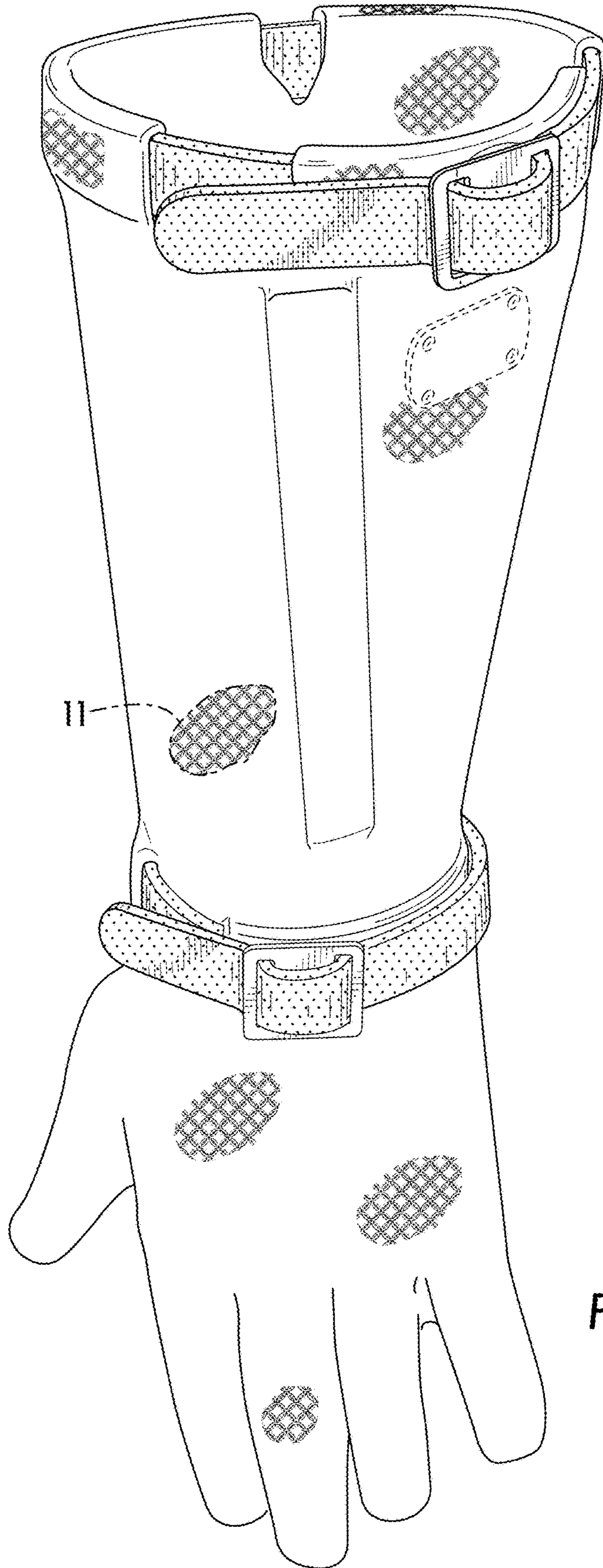

FIG. 1

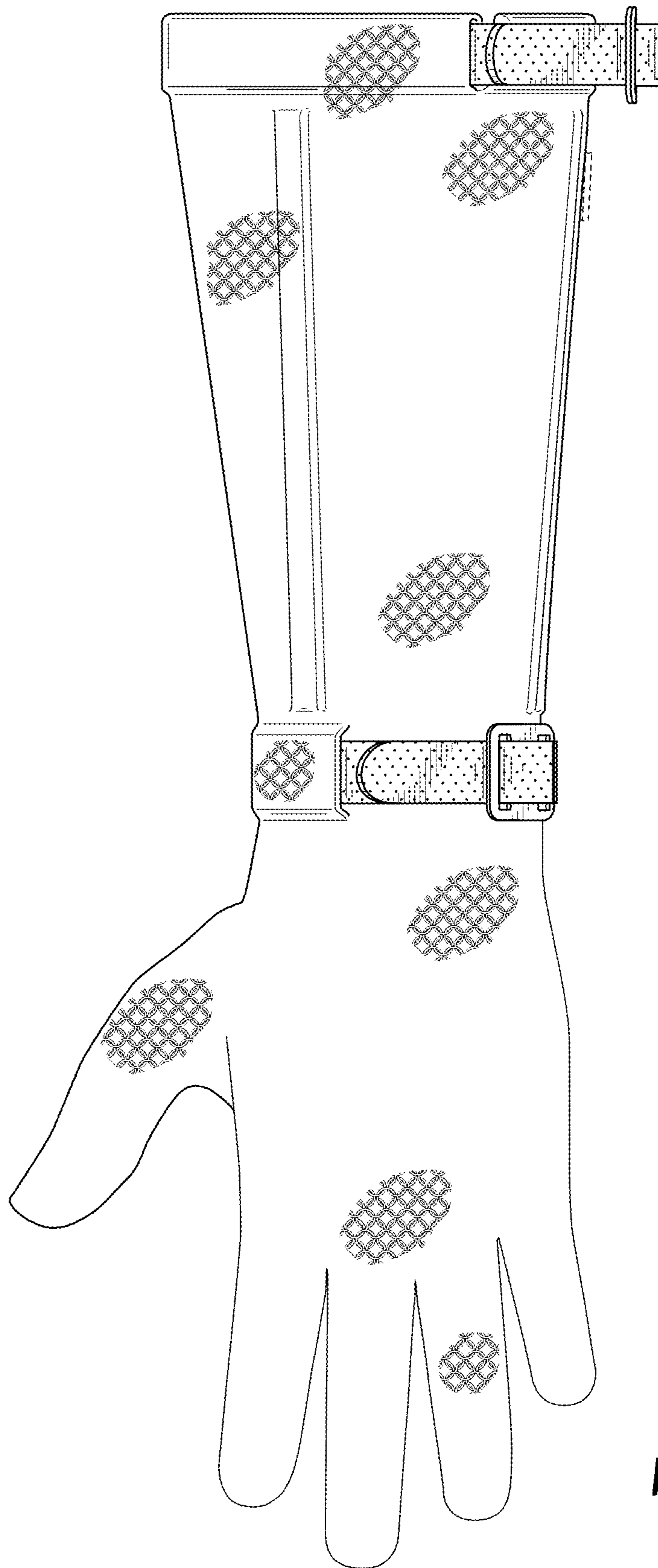

FIG. 2

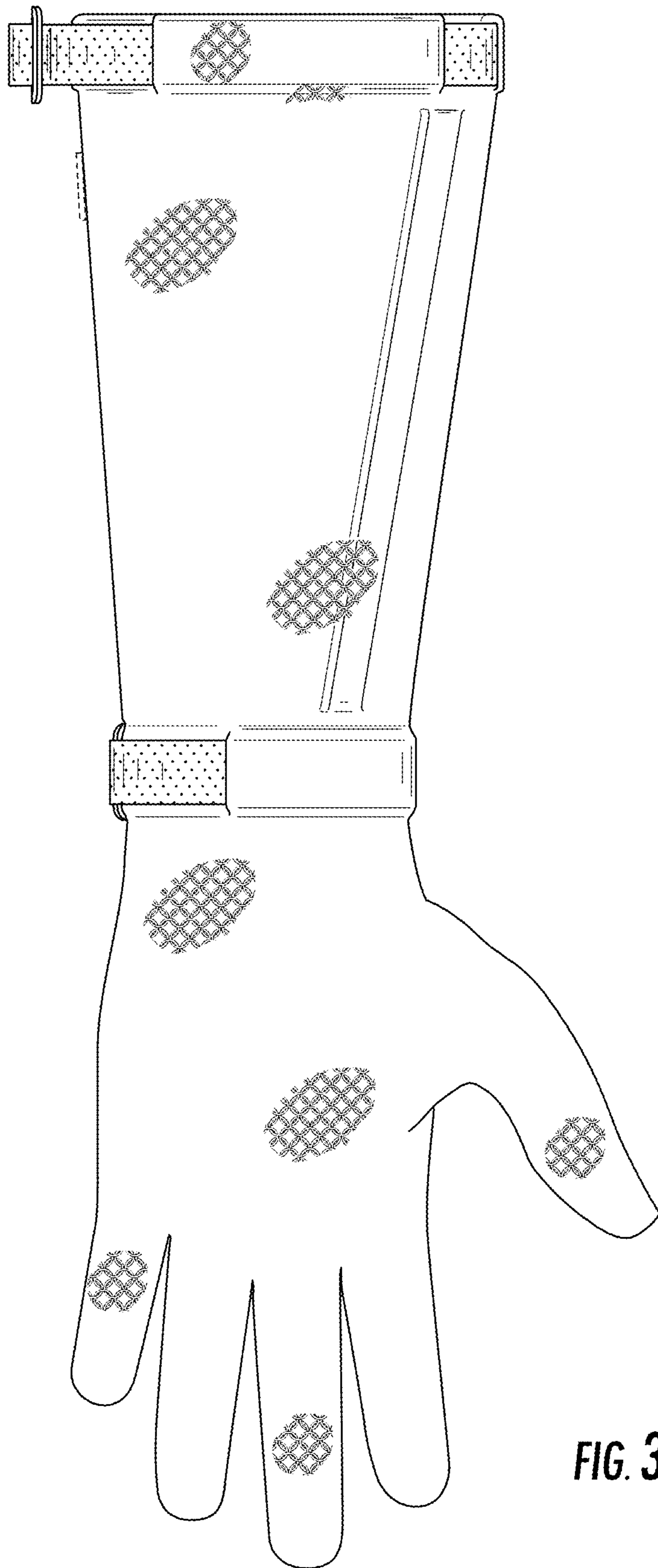

FIG. 3

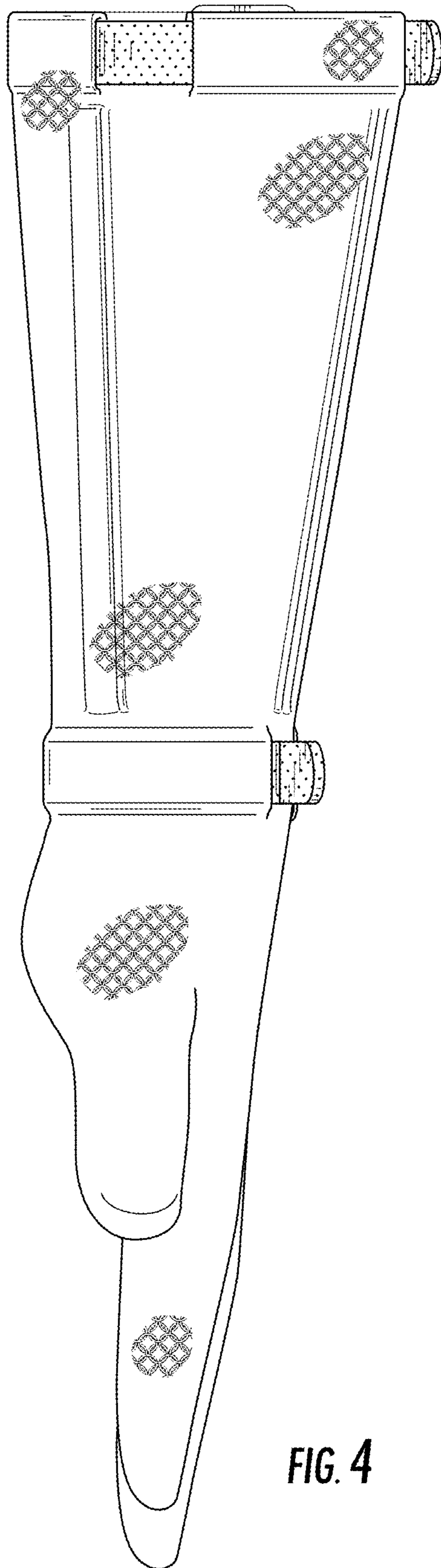

FIG. 4

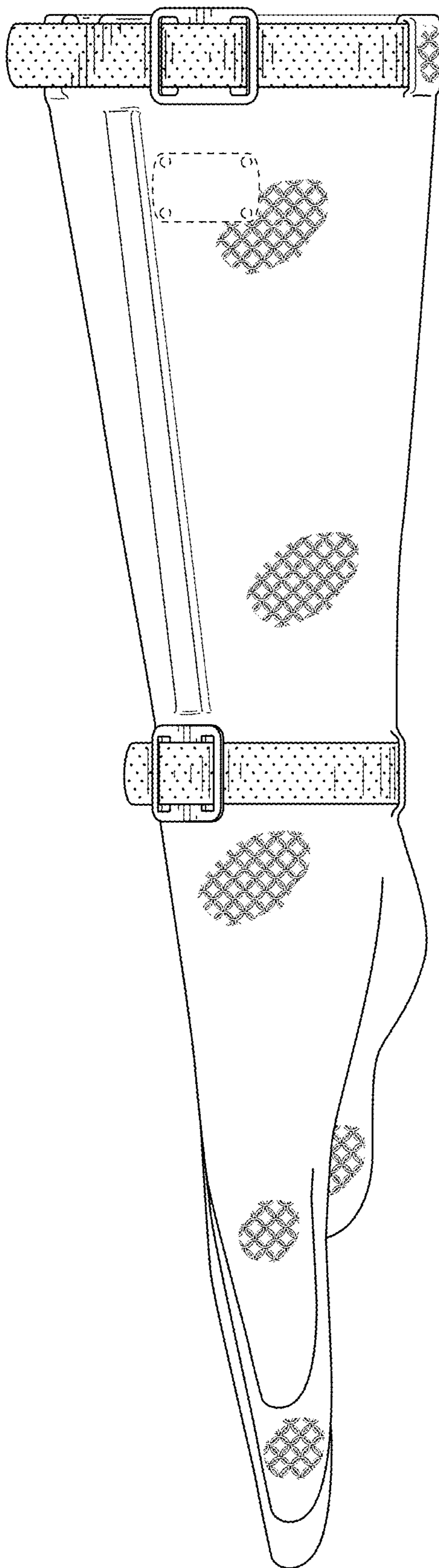

FIG. 5

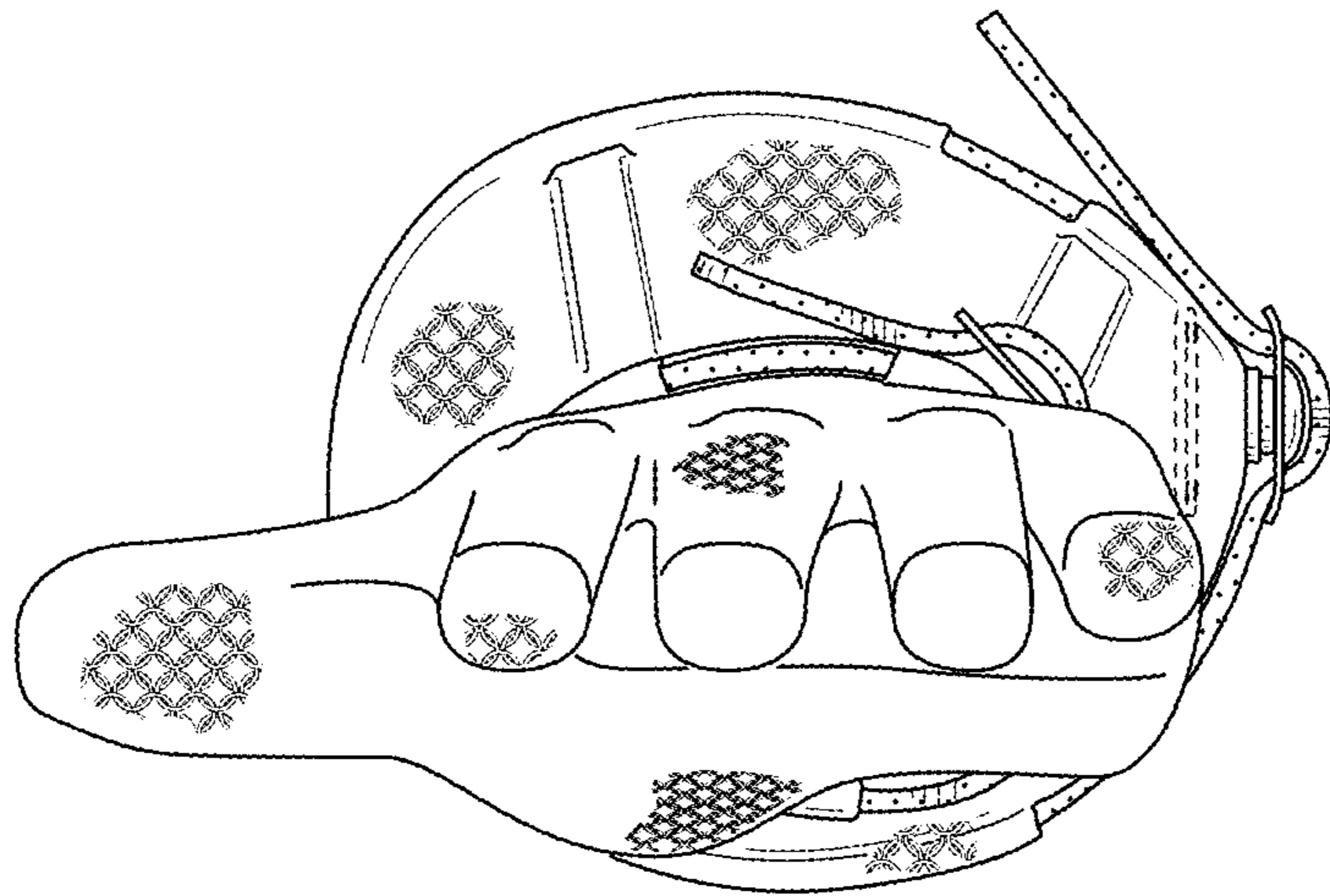

FIG. 6

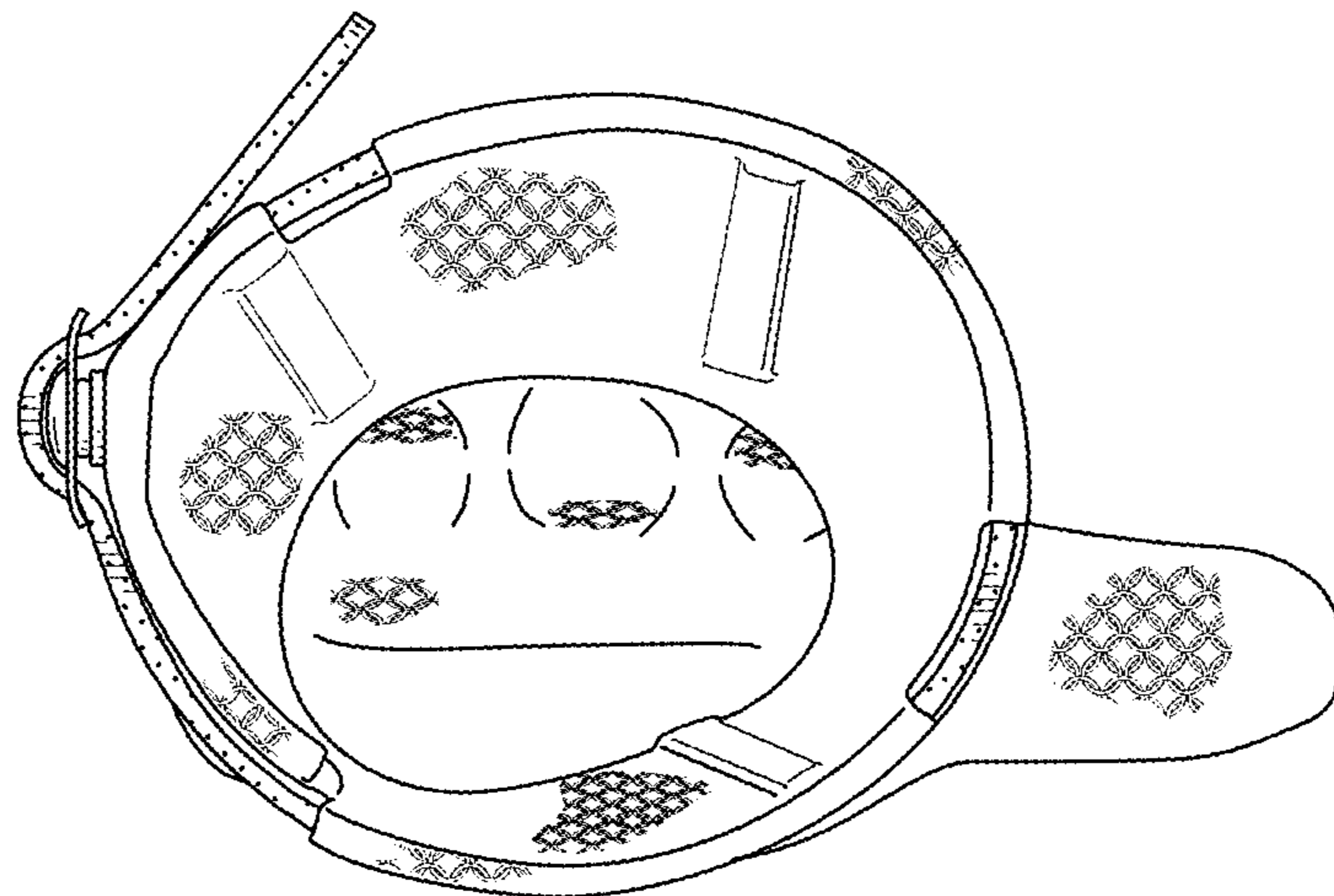

FIG. 7

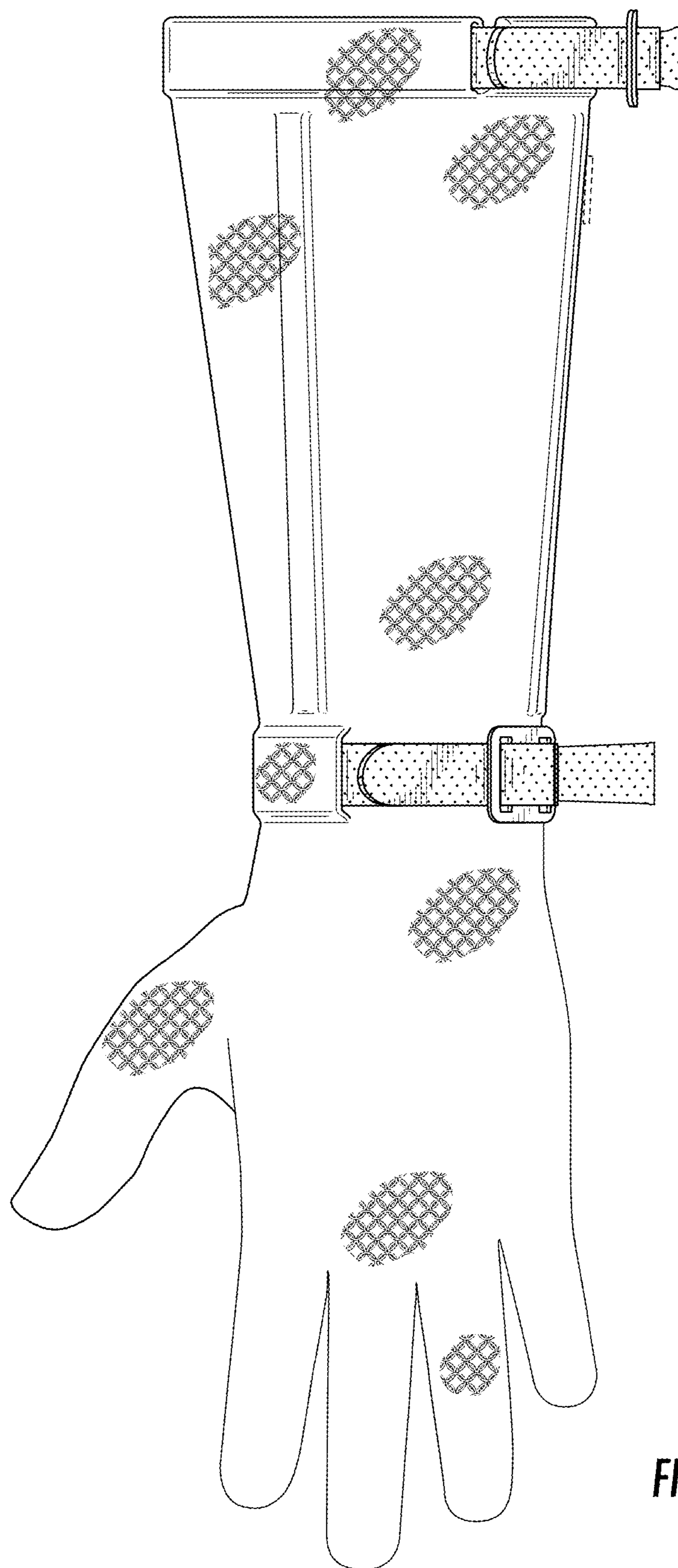

FIG. 8

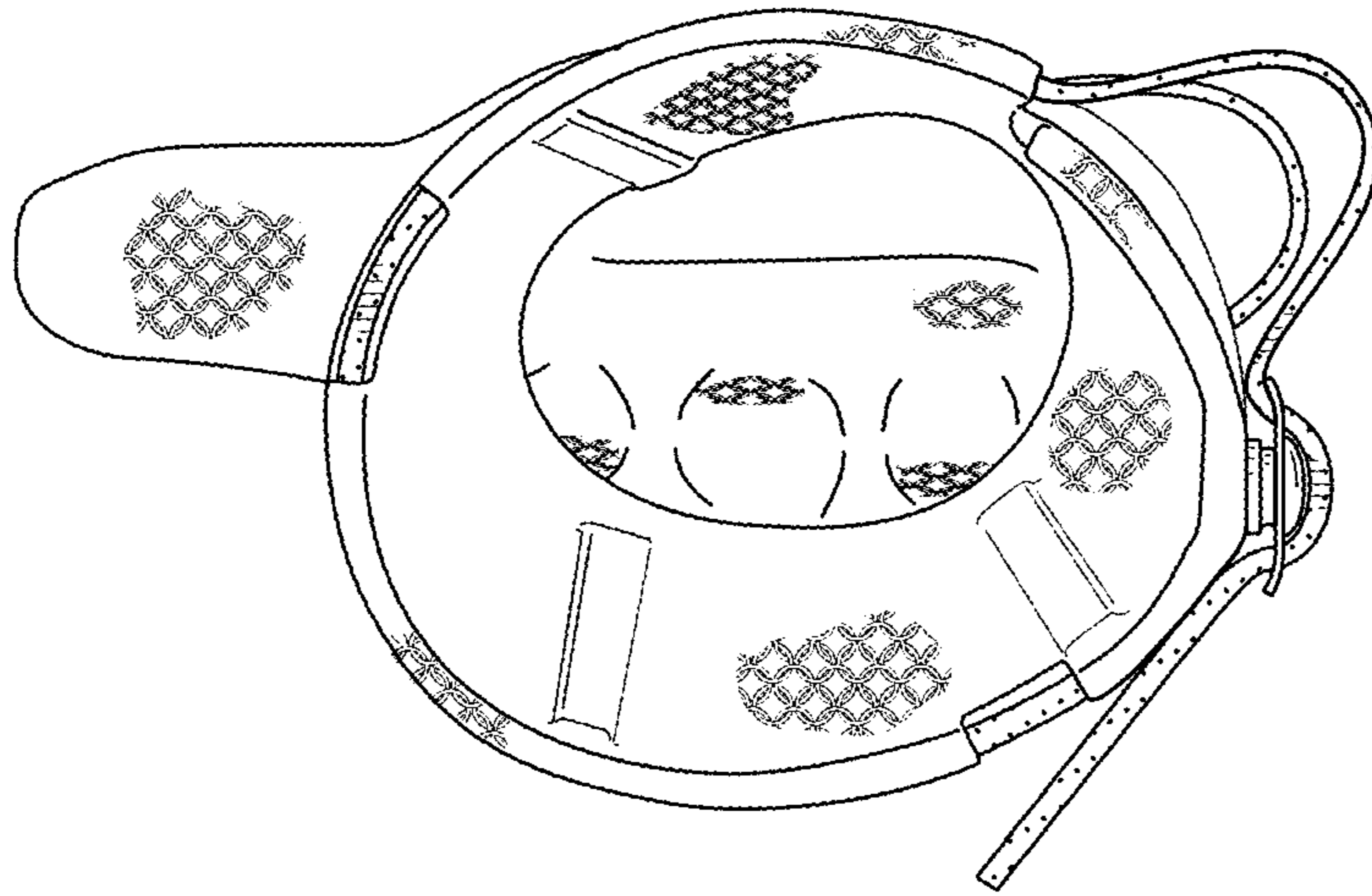

FIG. 9

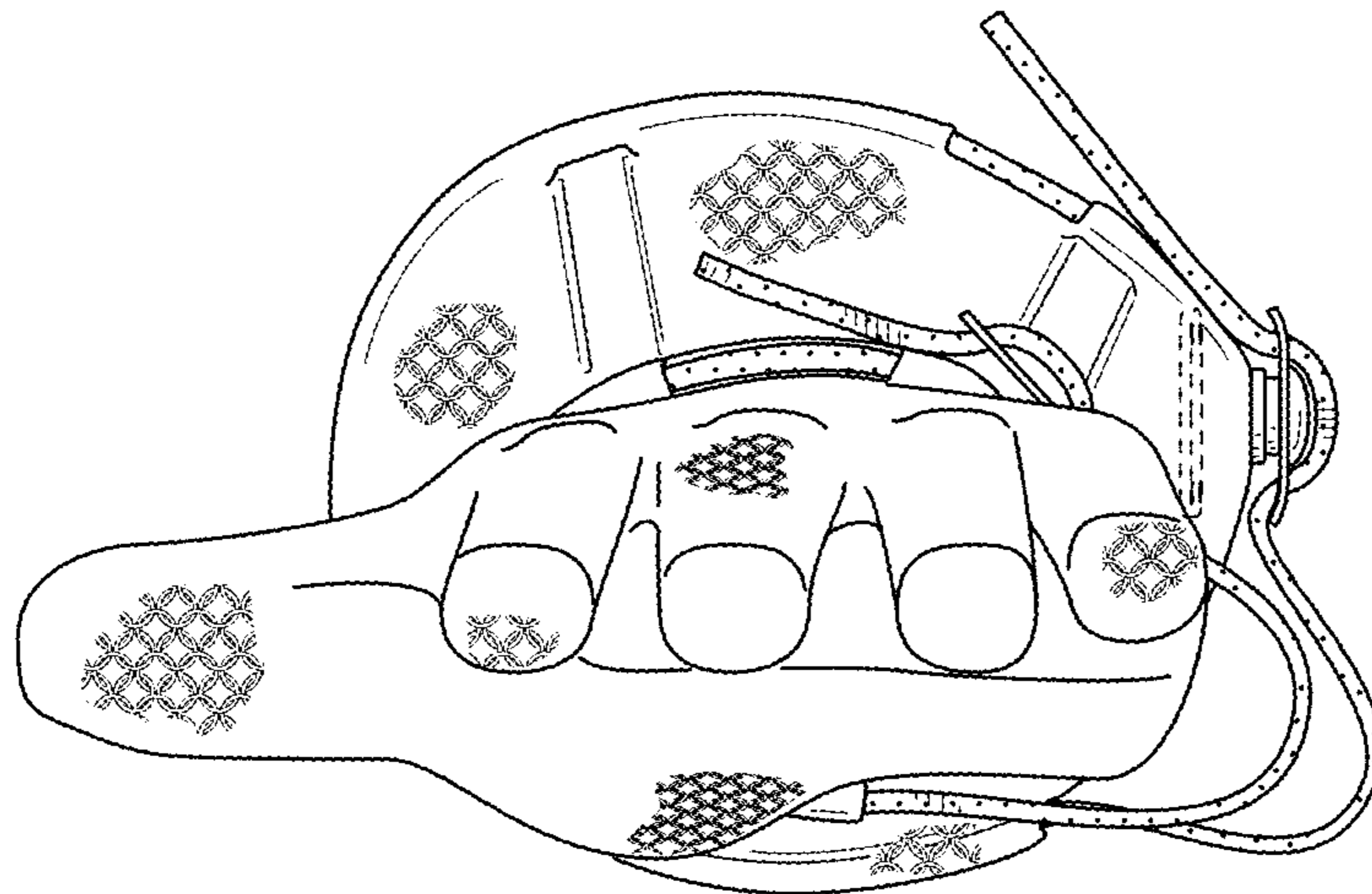

FIG. 10

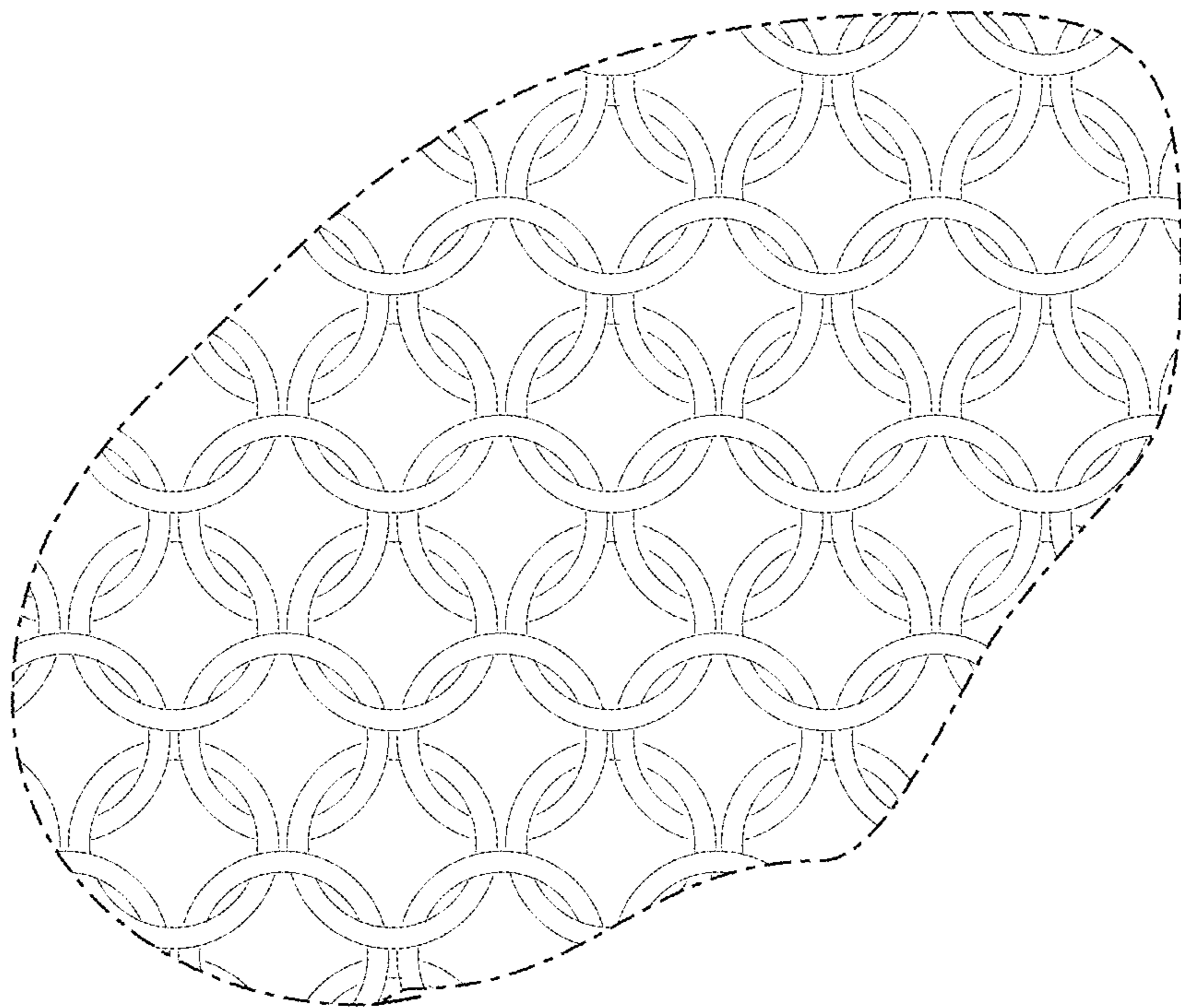

FIG. 11

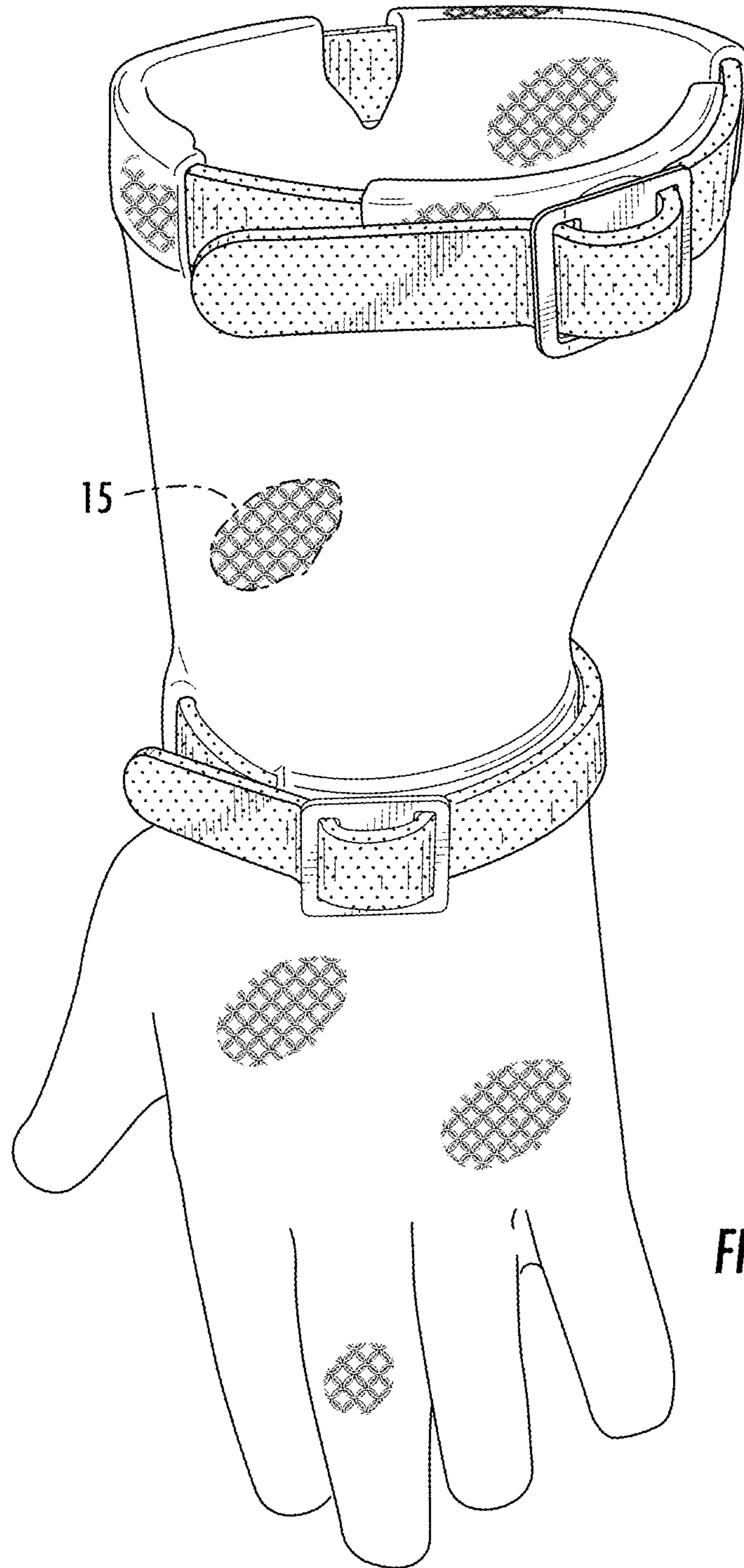

FIG. 12

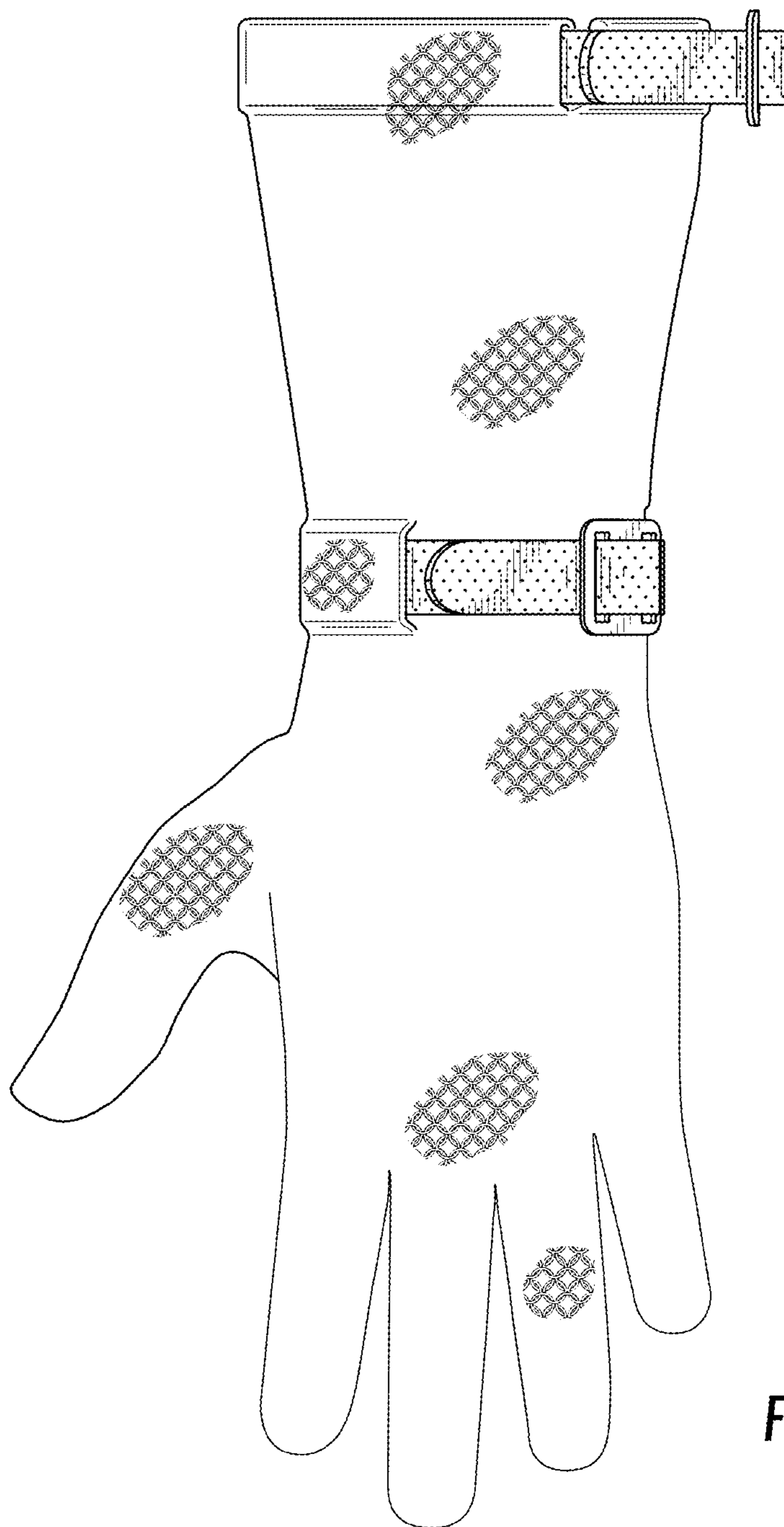

FIG. 13

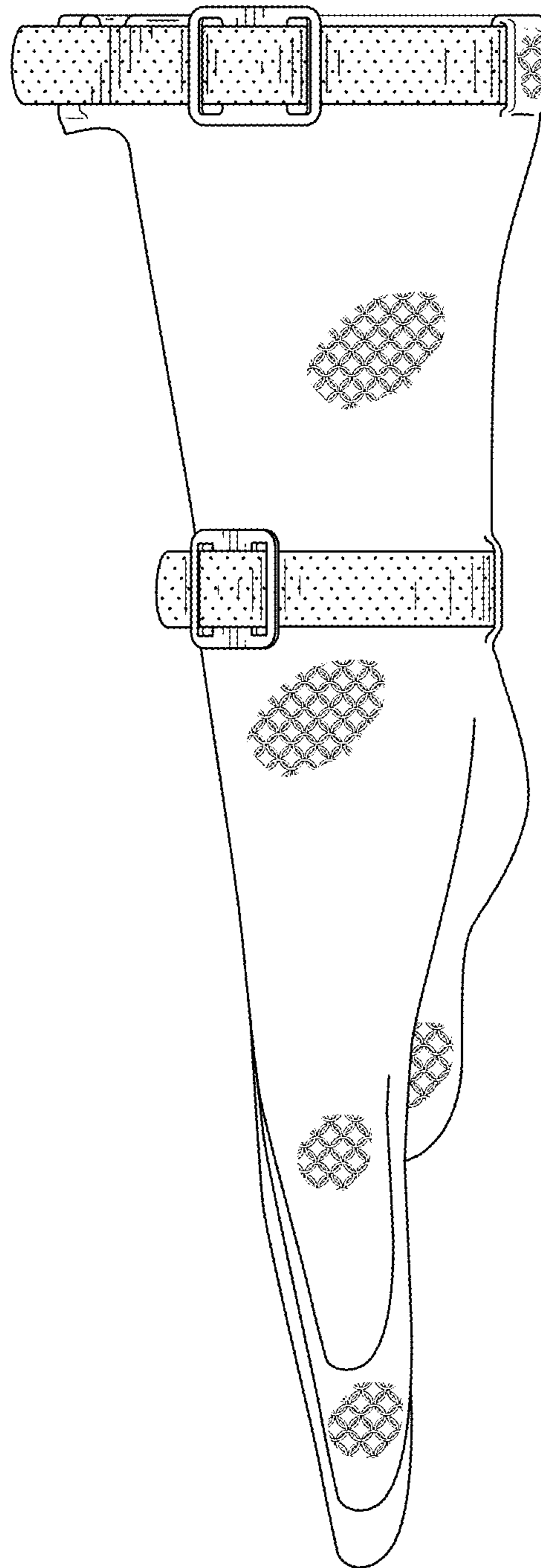

FIG. 14

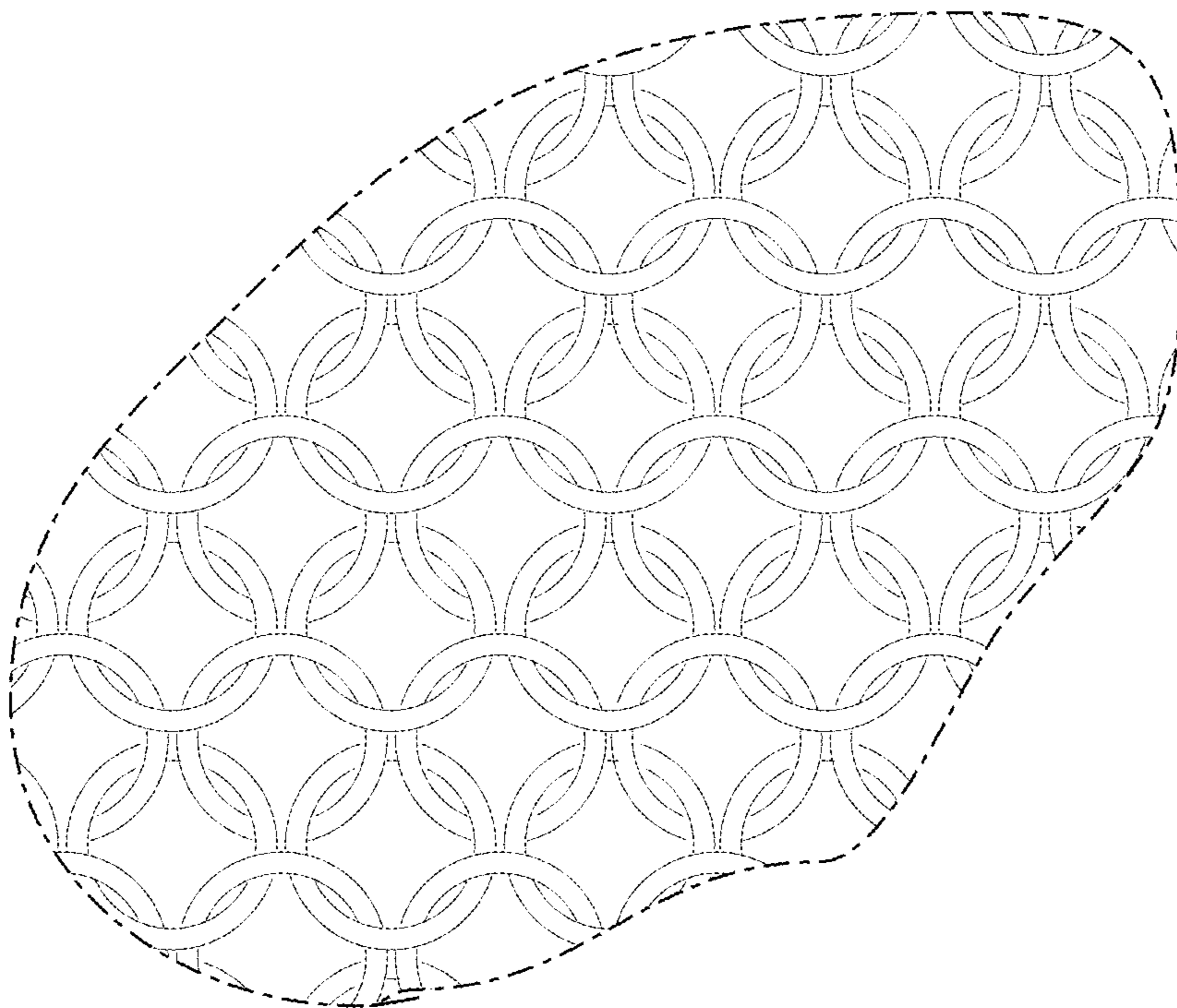

FIG. 15

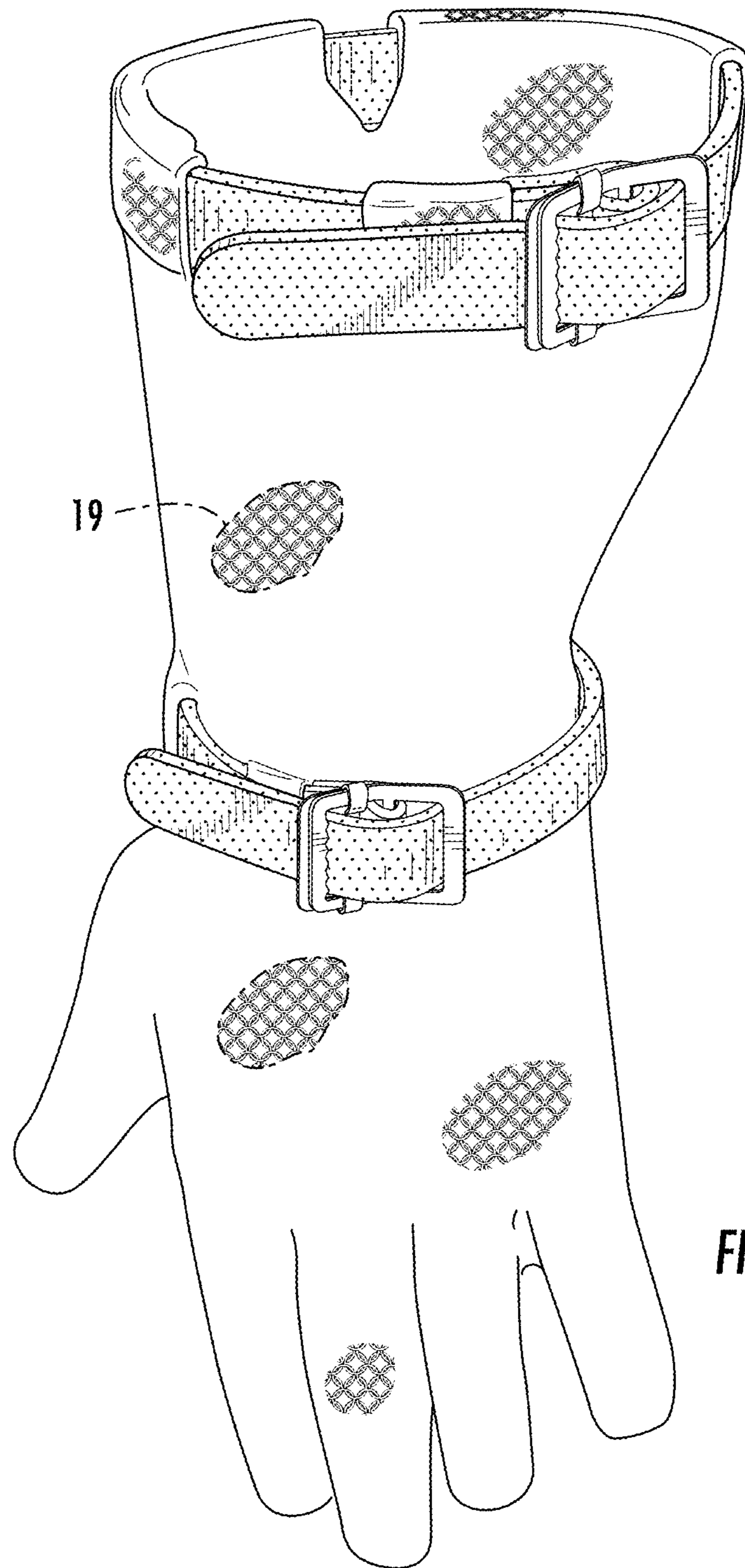

FIG. 16

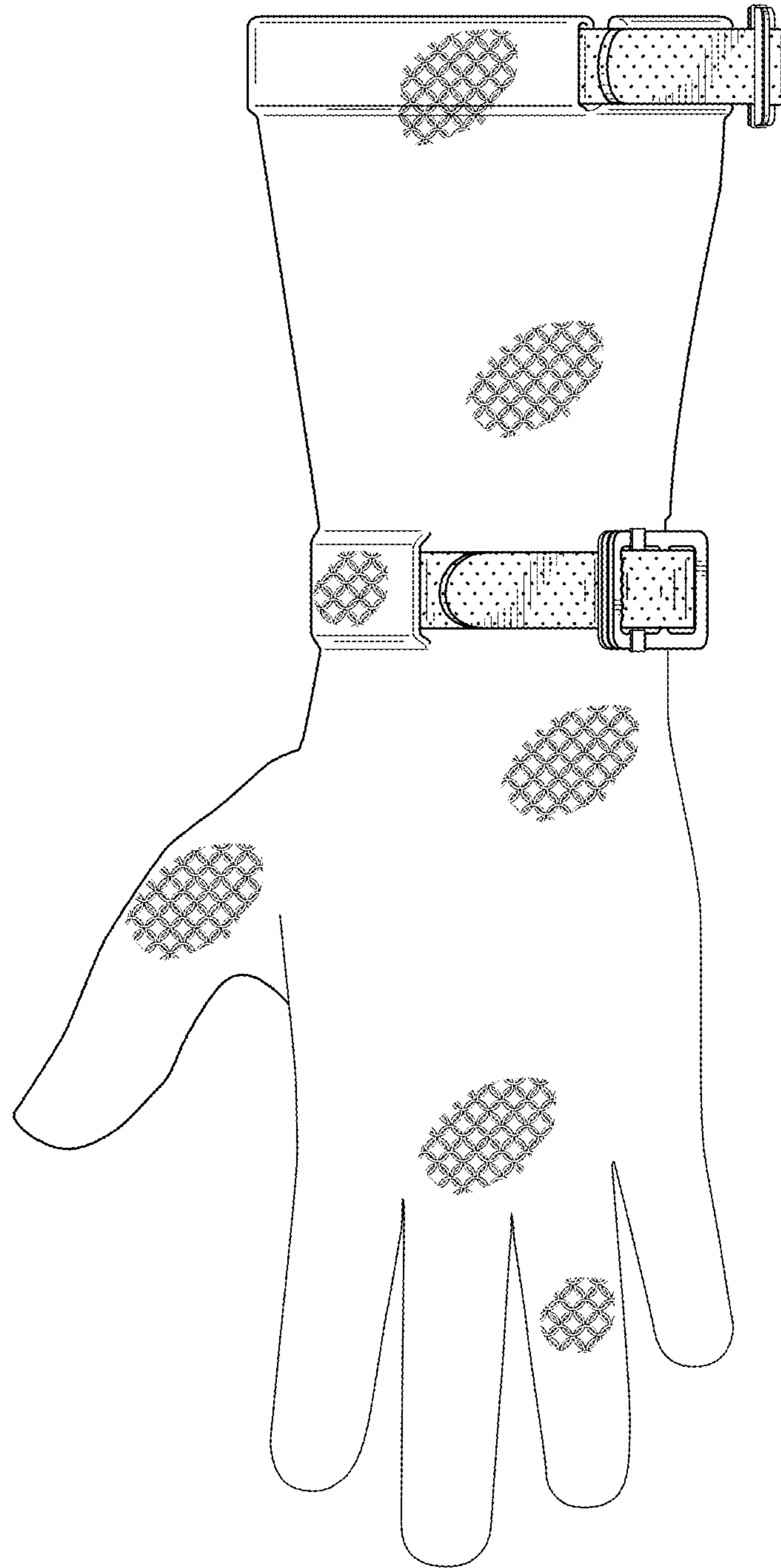

FIG. 17

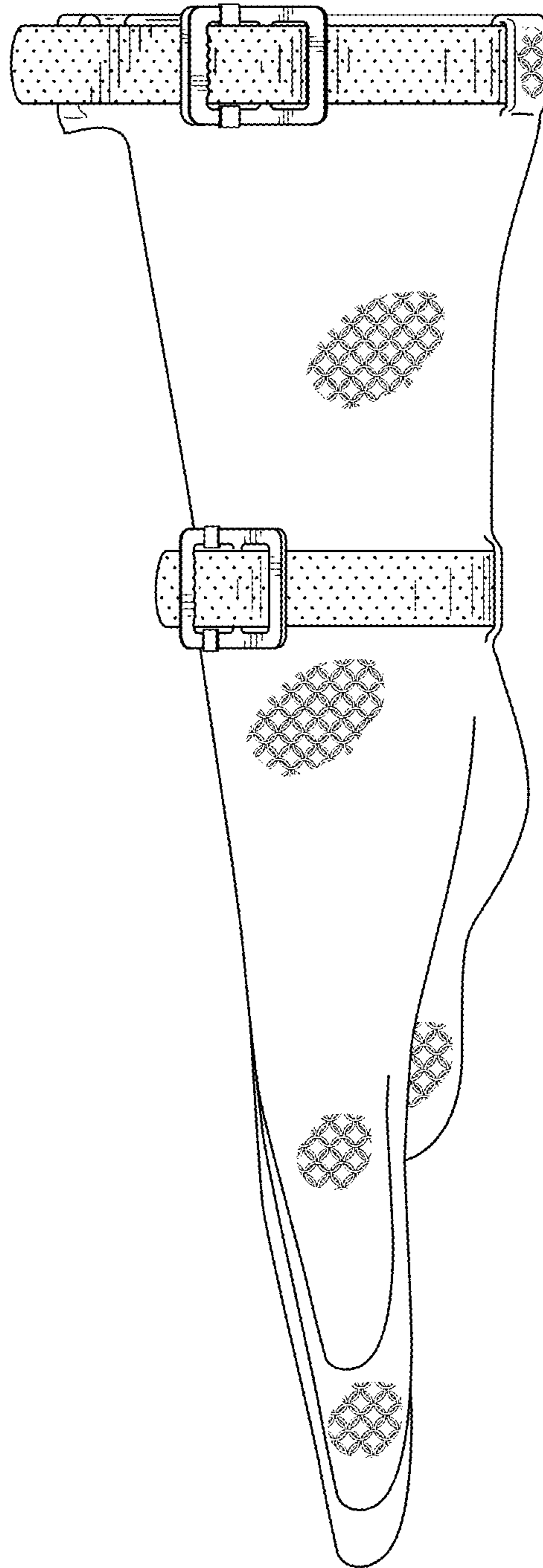

FIG. 18

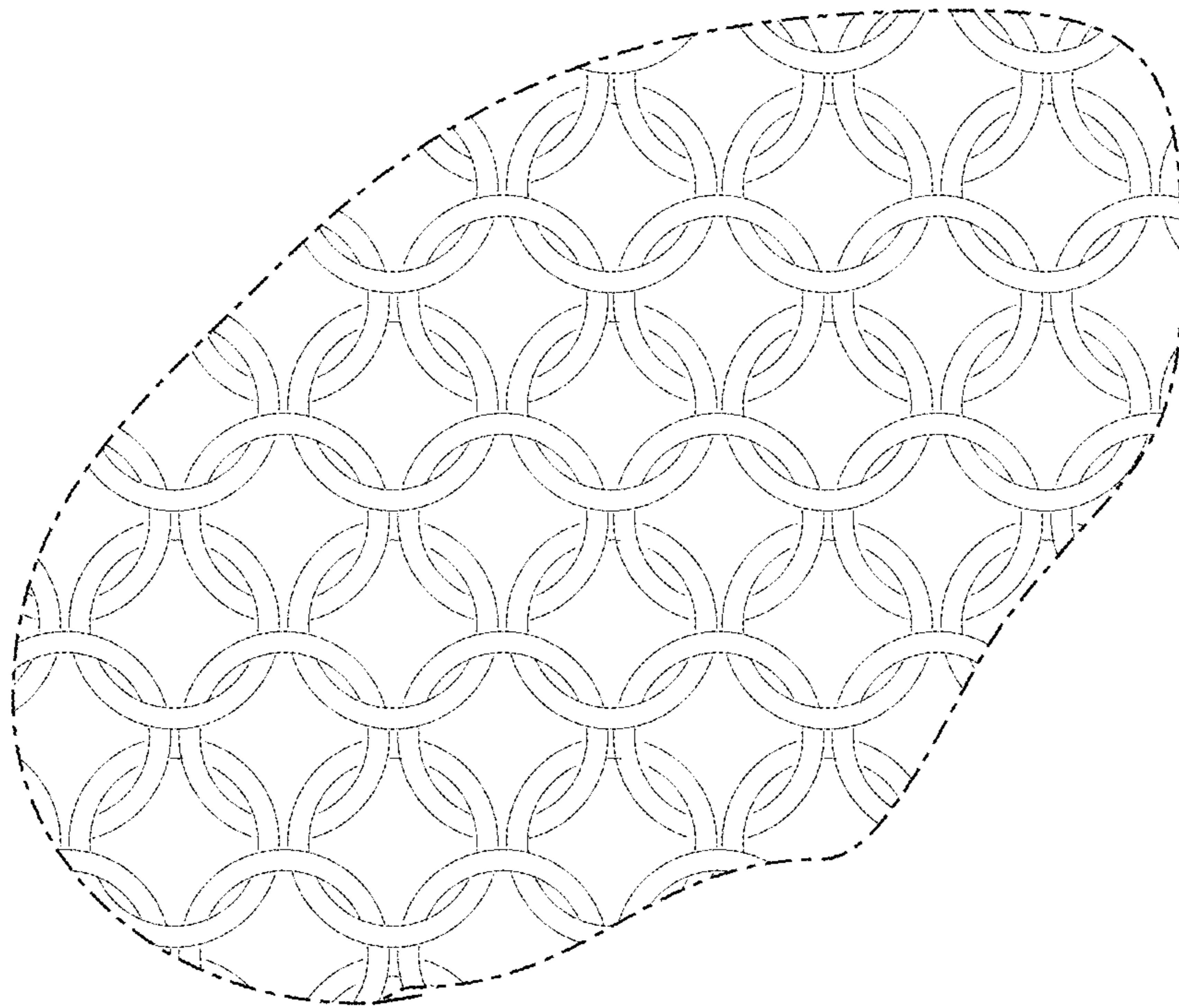

FIG. 19

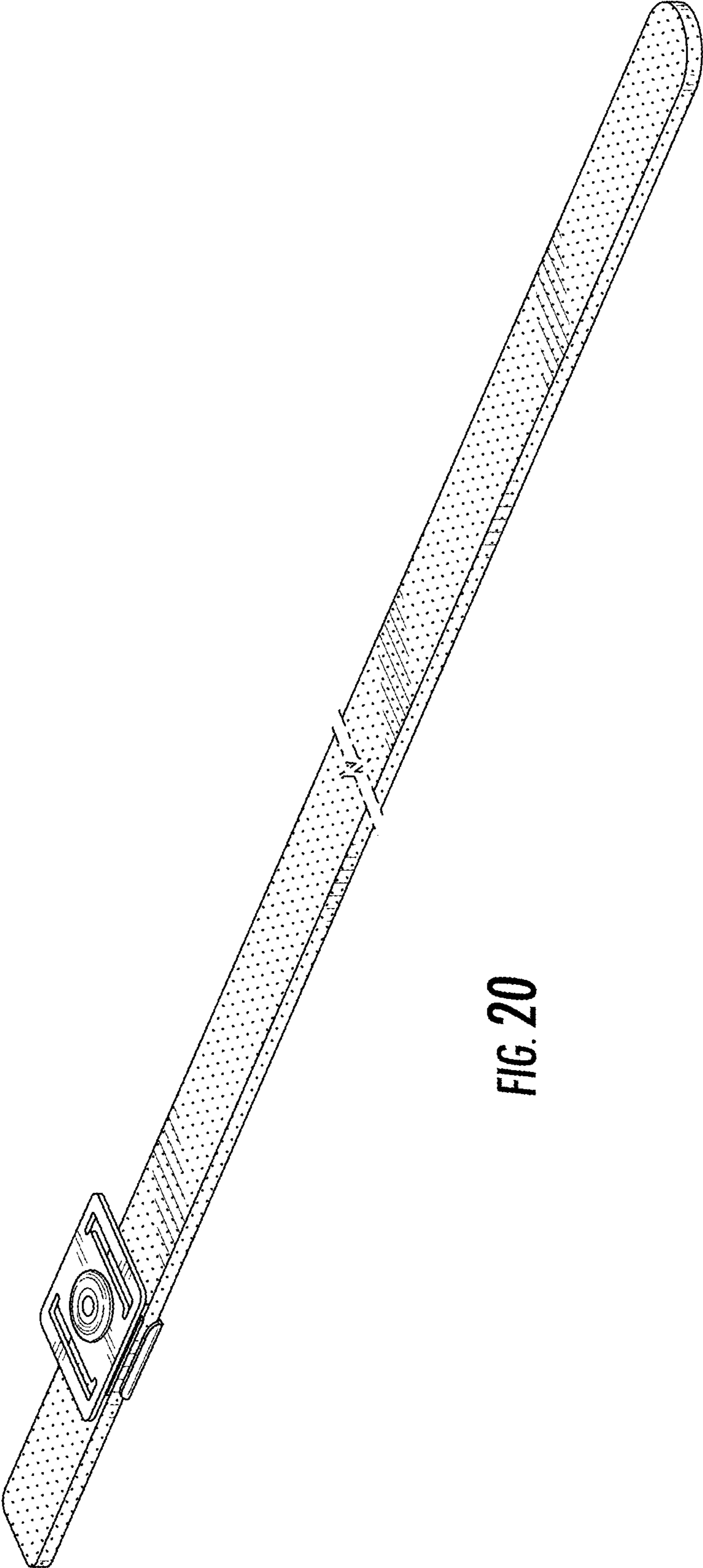

FIG. 20

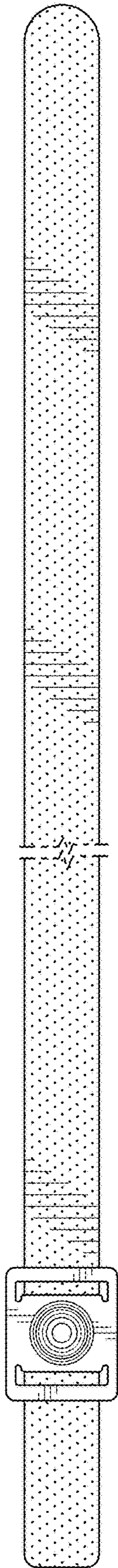

FIG. 21

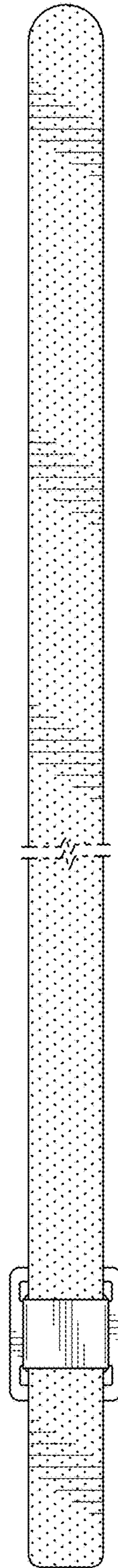

FIG. 22

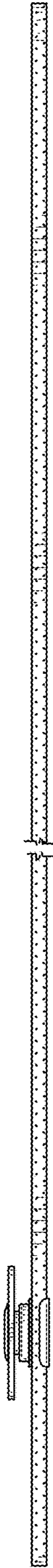

FIG. 23

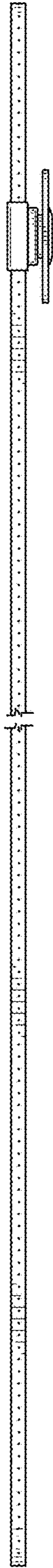

FIG. 24



FIG. 25



FIG. 26

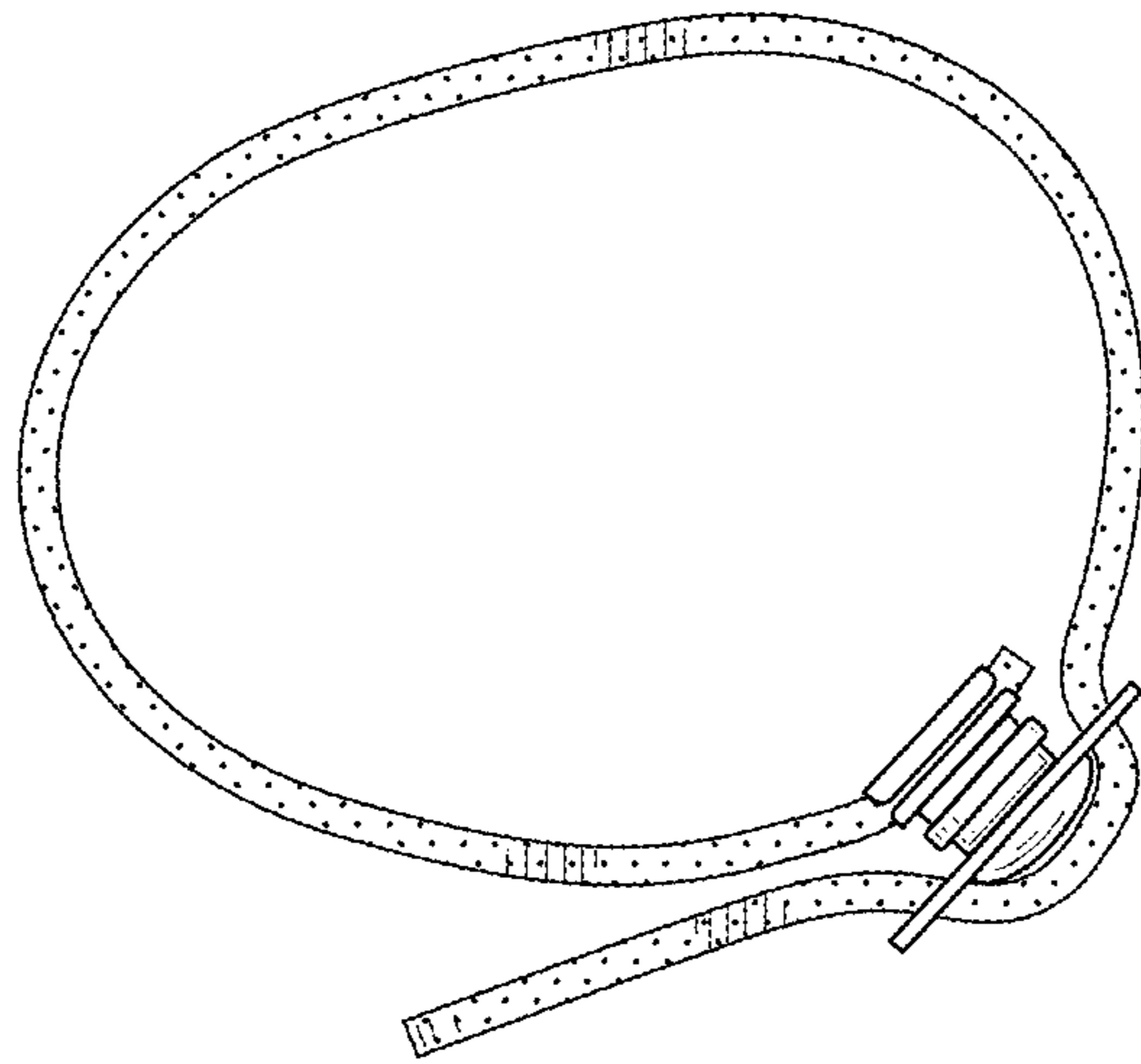

FIG. 27

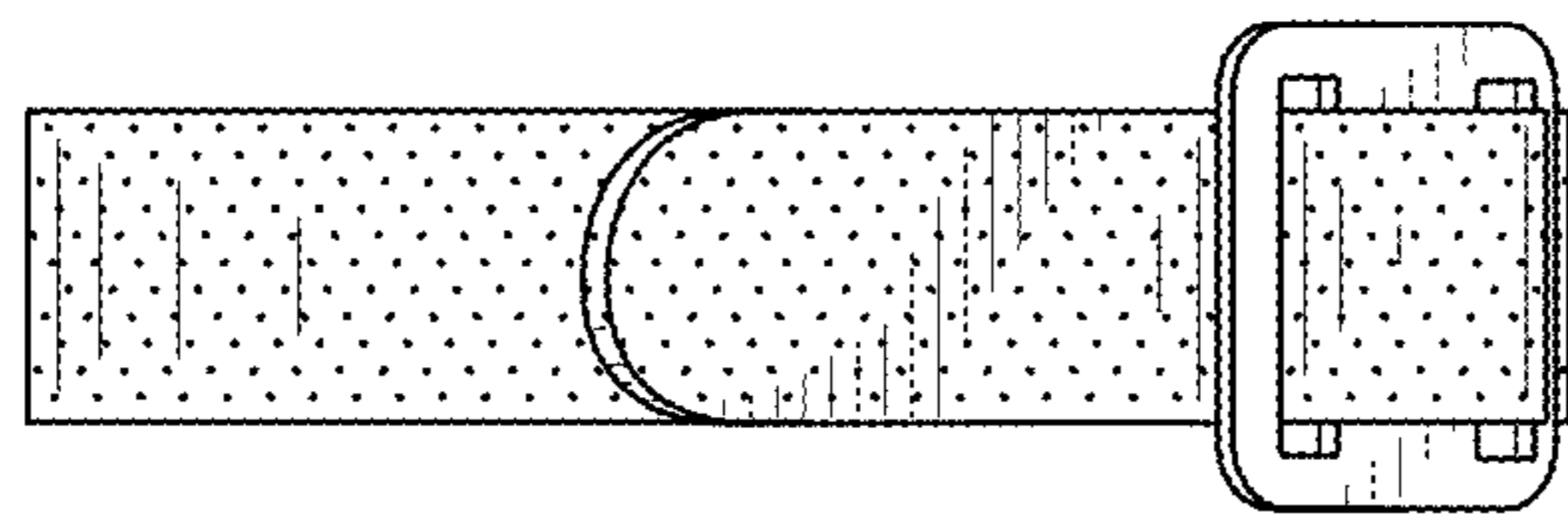

FIG. 28

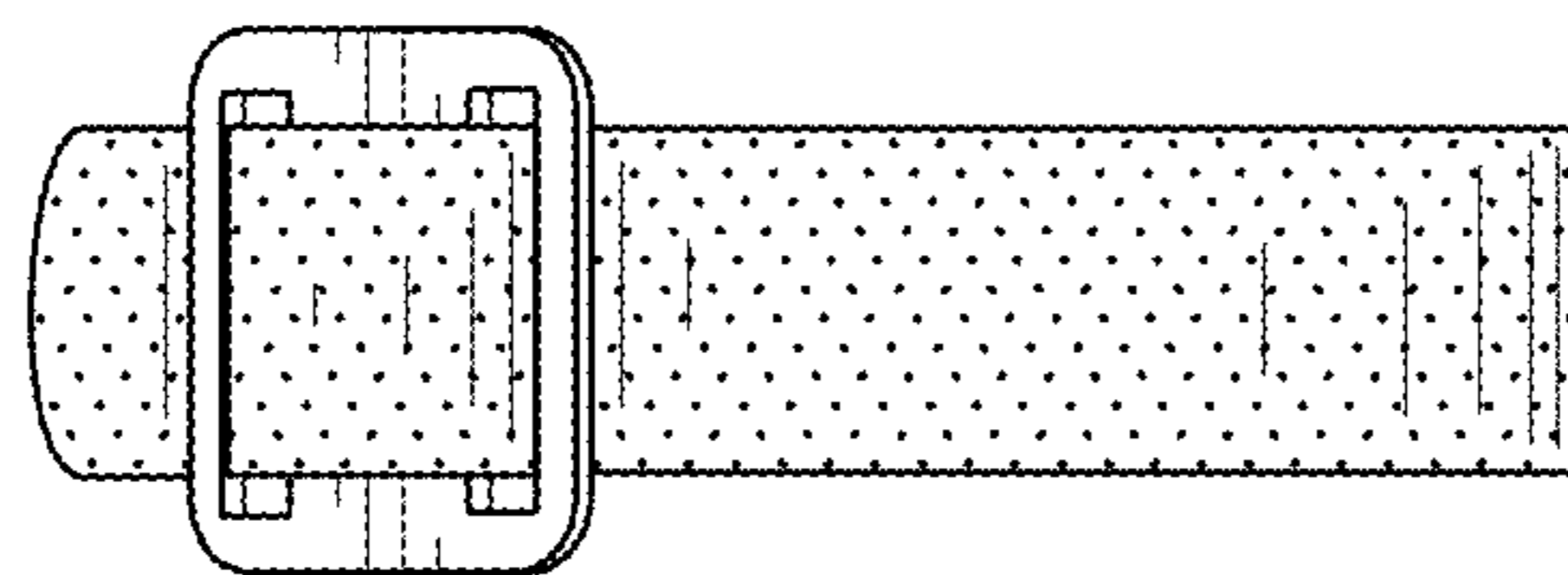

FIG. 29

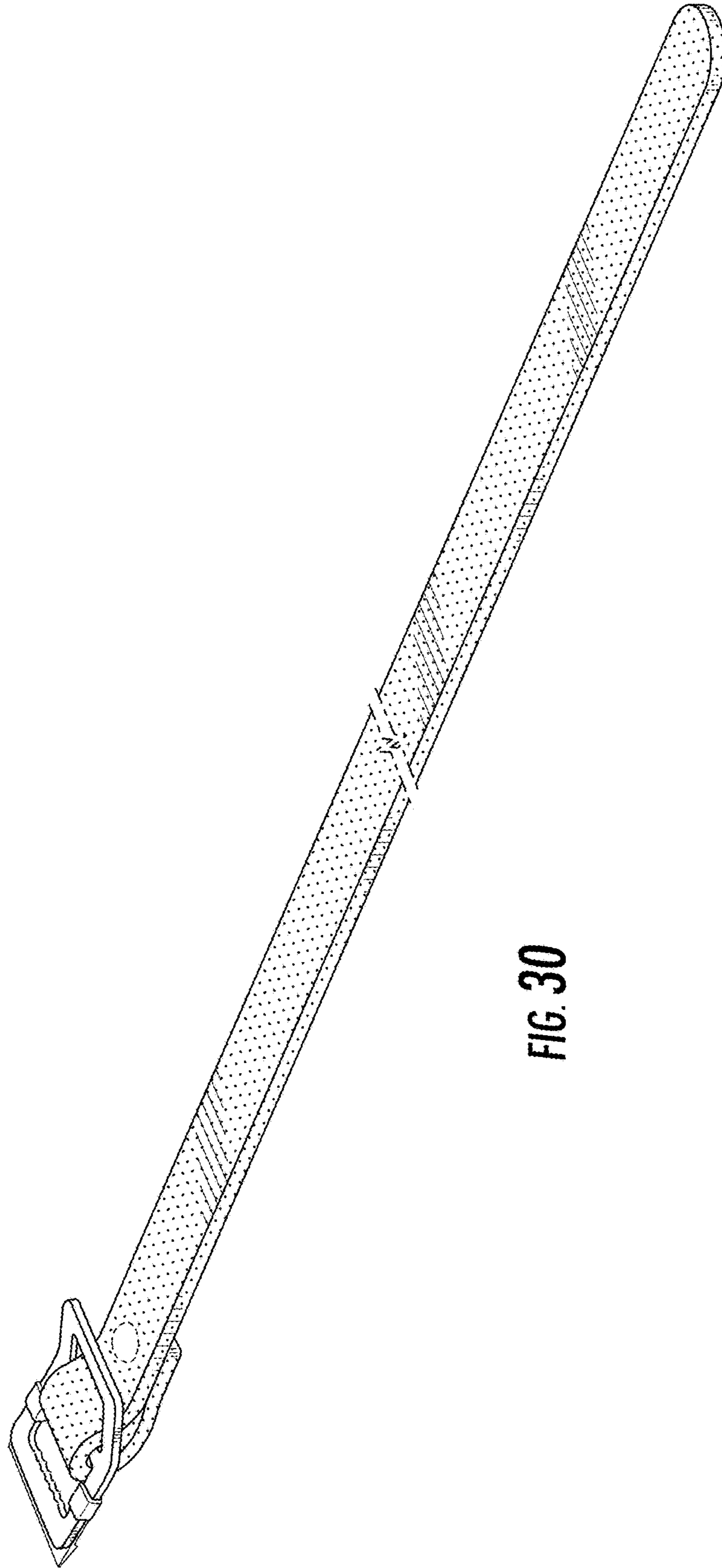

FIG. 30

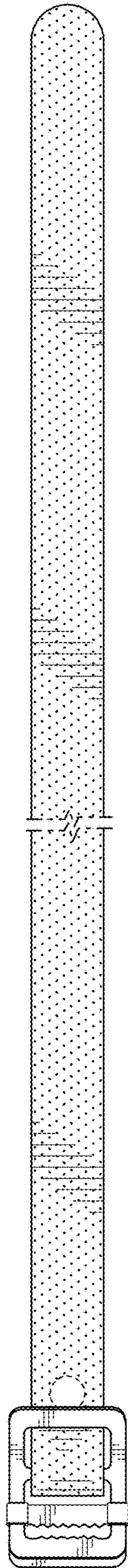

FIG. 31

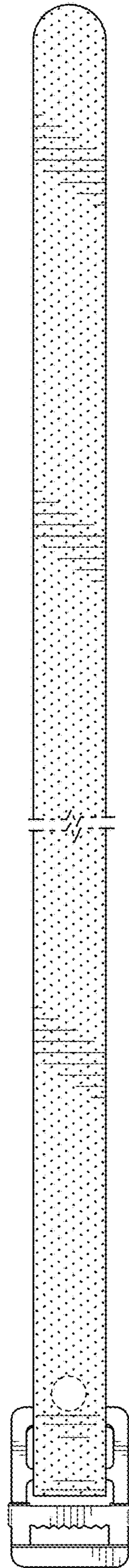

FIG. 32

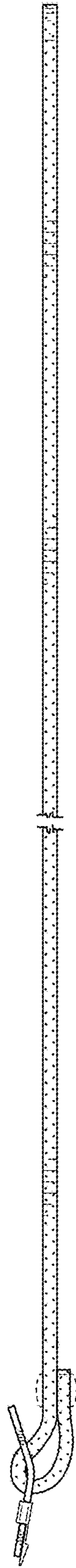

FIG. 33

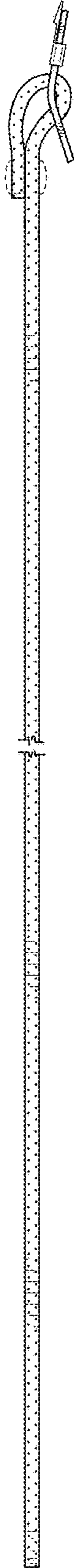

FIG. 34

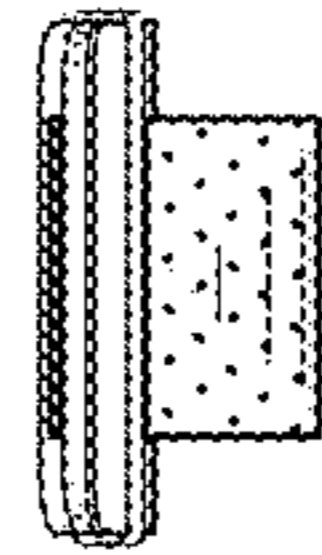

FIG. 35



FIG. 36