



US00D802189S

(12) **United States Design Patent**  
**Windom et al.**

(10) **Patent No.:** **US D802,189 S**  
(45) **Date of Patent:** **\*\* Nov. 7, 2017**

(54) **HEADLAMP**

(71) Applicant: **Coast Cutlery Co.**, Portland, OR (US)

(72) Inventors: **Gregory David Windom**, Portland, OR (US); **David Lewin**, Portland, OR (US)

(73) Assignee: **COAST CUTLERY CO.**, Portland, OR (US)

(\*\*) Term: **15 Years**

(21) Appl. No.: **29/547,897**

(22) Filed: **Dec. 8, 2015**

(51) **LOC (10) Cl.** ..... **26-02**

(52) **U.S. Cl.**  
USPC ..... **D26/39**

(58) **Field of Classification Search**  
USPC ..... D26/39, 37, 38, 42, 46, 50, 362;  
362/103, 105, 108, 106; 2/422  
CPC . A42B 3/044; A42B 3/04; F21L 15/14; F21L  
11/00; B63C 9/20  
See application file for complete search history.

(56) **References Cited**

**U.S. PATENT DOCUMENTS**

- 5,226,712 A \* 7/1993 Lucas ..... F21V 23/0414  
362/103
- D470,615 S \* 2/2003 Janice ..... D26/39
- D477,680 S \* 7/2003 Petzl ..... D26/39
- 6,736,529 B1 \* 5/2004 Lee ..... B62J 6/02  
362/105
- D492,052 S \* 6/2004 Schnell ..... D26/39
- 7,008,075 B2 \* 3/2006 Simoni ..... A01K 27/006  
119/859
- D528,678 S \* 9/2006 Yen ..... D26/28
- D552,278 S \* 10/2007 Spartano ..... D26/39
- 7,293,898 B2 \* 11/2007 Kumthampinij ..... F21L 4/027  
362/184
- D560,008 S \* 1/2008 Poon ..... D26/39
- 7,377,665 B2 \* 5/2008 Langenwalter ..... A44B 11/005  
362/103

- D578,691 S \* 10/2008 Lau ..... D26/39
- D581,567 S \* 11/2008 Crawford ..... D26/38
- 7,506,992 B2 \* 3/2009 Carter ..... F21L 4/00  
2/209.13
- D592,781 S \* 5/2009 Petzl ..... D26/39  
(Continued)

**FOREIGN PATENT DOCUMENTS**

EM 003301357-0001 \* 8/2016

**OTHER PUBLICATIONS**

NPL #1: Multi-Function LED Headlamp, Aennon, posted at lady-nightwater.blogspot.com, posting Mar. 6, 2015, © 2009 Butterfly Acres, [online], [site visited Nov. 4, 2016]. Available from Internet, <URL: <http://lady-nightwater.blogspot.com/2015/03/multi-function-led-headlamp-for.html>.\*

*Primary Examiner* — Lakiya Rogers  
*Assistant Examiner* — Altaira Swangin  
(74) *Attorney, Agent, or Firm* — Schwabe Williamson & Wyatt, P.C.

(57) **CLAIM**

We claim the ornamental design for a headlamp, as shown and described.

**DESCRIPTION**

FIG. 1 is a perspective view of a headlamp, showing our new design;  
FIG. 2 is a front view thereof;  
FIG. 3 is a back view thereof;  
FIG. 4 is a right view thereof;  
FIG. 5 is a left view thereof;  
FIG. 6 is a top view thereof; and,  
FIG. 7 is a bottom view thereof.  
The dashed lines are included for illustrating unclaimed portions of the article and form no part of the claimed design.

**1 Claim, 5 Drawing Sheets**

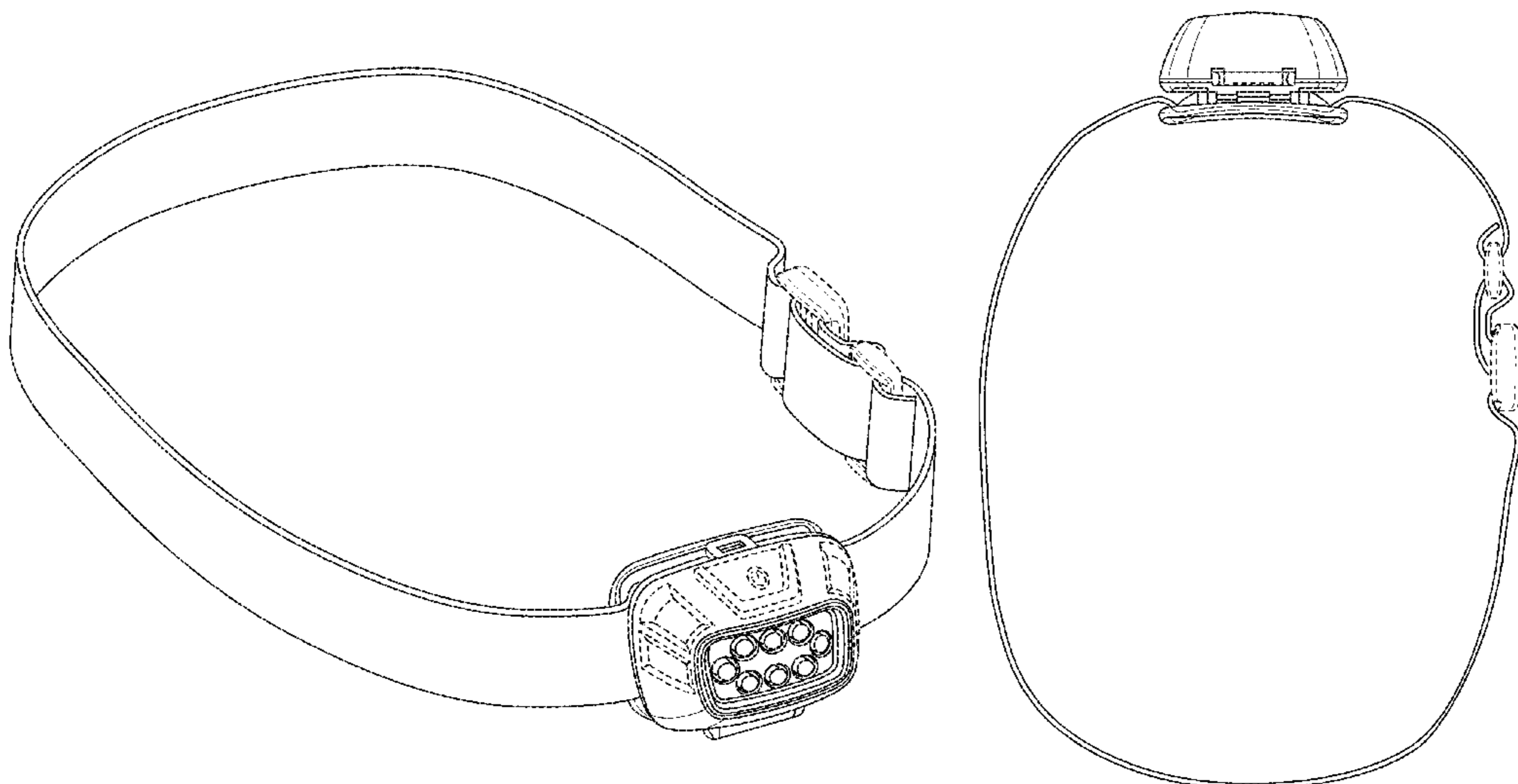

(56)

References Cited

U.S. PATENT DOCUMENTS

7,568,812 B1 *	8/2009	Kumthampinij .....	F21L 4/04	D734,887 S *	7/2015	Gebhard .....	D26/63
			362/105	D742,050 S *	10/2015	Inskeep .....	D26/39
D615,225 S *	5/2010	DeBrunner .....	D26/39	D742,051 S *	10/2015	Abernethy .....	D26/39
D615,226 S *	5/2010	Levine .....	D26/44	D743,596 S *	11/2015	Ormsbee .....	D26/39
D615,678 S *	5/2010	DeBrunner .....	D26/39	D743,597 S *	11/2015	Abernethy .....	D26/39
D624,221 S *	9/2010	DeBrunner .....	D26/39	9,194,548 B2 *	11/2015	Janice .....	F21L 4/02
7,810,946 B2 *	10/2010	Jarzac .....	F21L 4/027	D751,739 S *	3/2016	Hamasaki .....	D26/28
			362/190	D783,873 S *	4/2017	Wallach .....	D26/51
D632,816 S *	2/2011	Lee .....	D26/48	D788,209 S *	5/2017	Greene .....	D16/300
D636,509 S *	4/2011	Killion .....	D26/46	D788,337 S *	5/2017	Koshiba .....	D26/39
D636,510 S *	4/2011	Killion .....	D26/46	D788,339 S *	5/2017	Koshiba .....	D26/39
D642,714 S *	8/2011	Chuah .....	D26/60	D788,340 S *	5/2017	Koshiba .....	D26/39
7,988,344 B2 *	8/2011	Ma .....	B62J 6/02	9,723,887 B2 *	8/2017	Kim .....	A42B 3/046
			362/473	9,726,356 B2 *	8/2017	Ormsbee .....	F21V 21/30
D651,732 S *	1/2012	Hopkins .....	D26/39	2006/0067077 A1 *	3/2006	Kumthampinij .....	F21L 4/027
D658,323 S *	4/2012	Freschl .....	D26/39				362/294
8,172,430 B2 *	5/2012	Alessio .....	F21L 14/00	2007/0177376 A1 *	8/2007	Simoni .....	F21L 4/00
			362/105				362/157
8,297,779 B2 *	10/2012	Martin .....	H01M 2/1055	2008/0253109 A1 *	10/2008	Canino .....	F21L 13/06
			362/194				362/105
D703,850 S *	4/2014	Alvarado .....	D26/39	2009/0323317 A1 *	12/2009	Spartano .....	F21V 14/065
D703,851 S *	4/2014	Gebhard .....	D26/44				362/105
D707,867 S *	6/2014	Kotsis .....	D26/39	2012/0057331 A1 *	3/2012	Janice .....	F21L 4/02
D715,473 S *	10/2014	Killion .....	D26/46				362/105
D723,201 S *	2/2015	Windom .....	D26/39	2012/0195026 A1 *	8/2012	Bouffay .....	F21V 21/084
D734,521 S *	7/2015	Gebhard .....	D26/63				362/105
				2015/0345760 A1 *	12/2015	Law .....	F21V 21/084
							362/105

\* cited by examiner

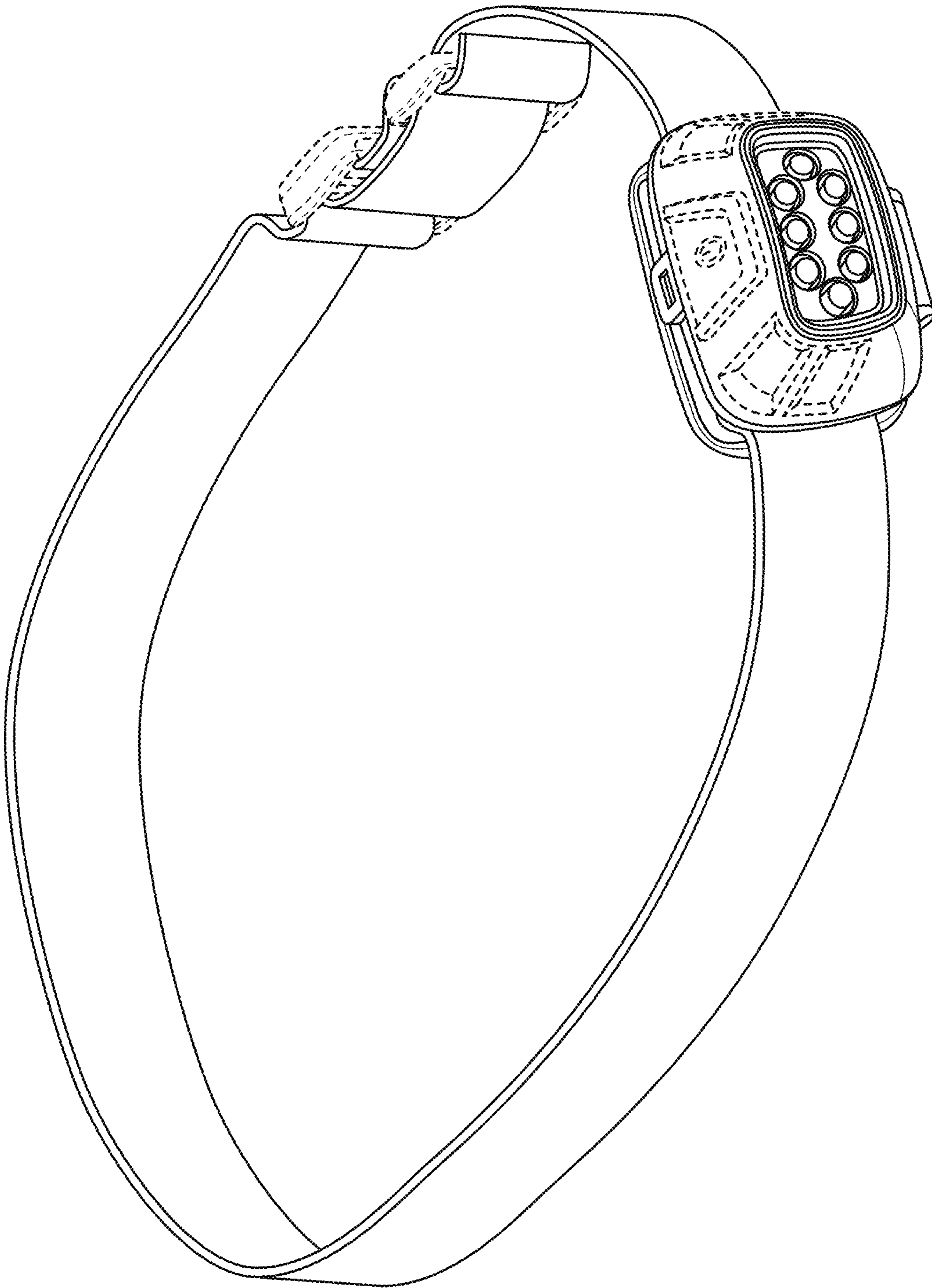

FIG. 1

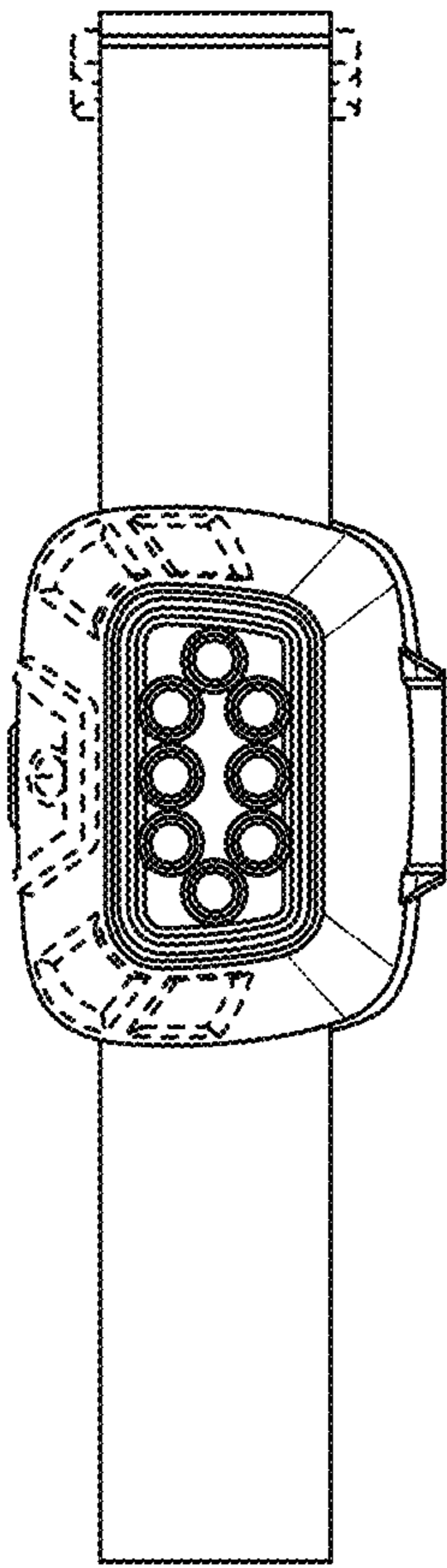

FIG. 2

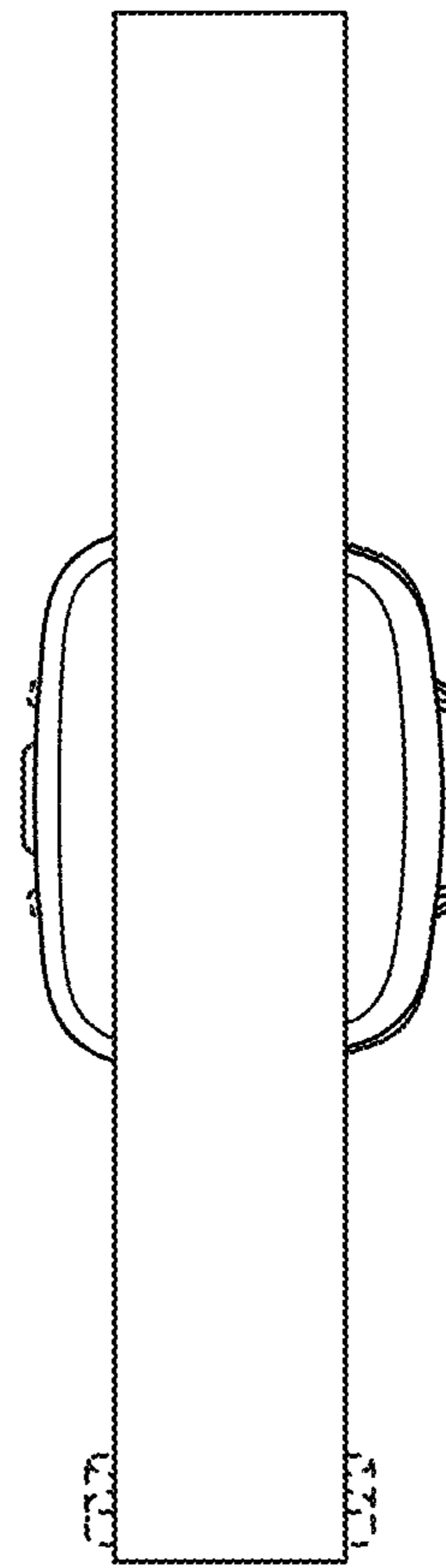

FIG. 3

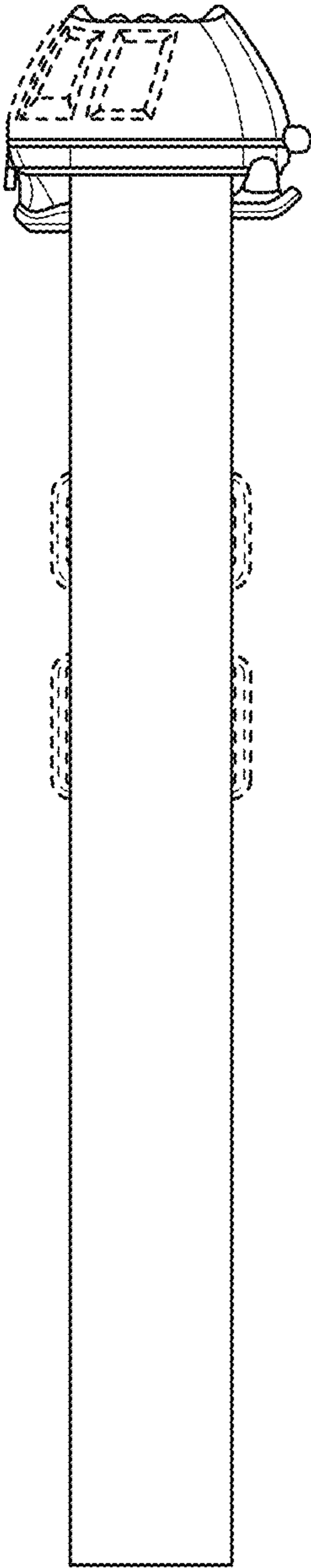

FIG. 4

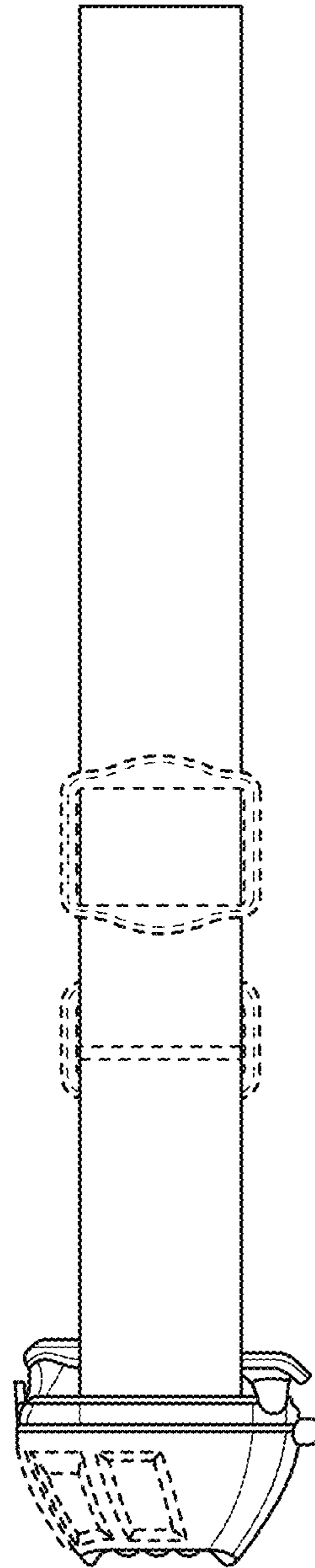

FIG. 5

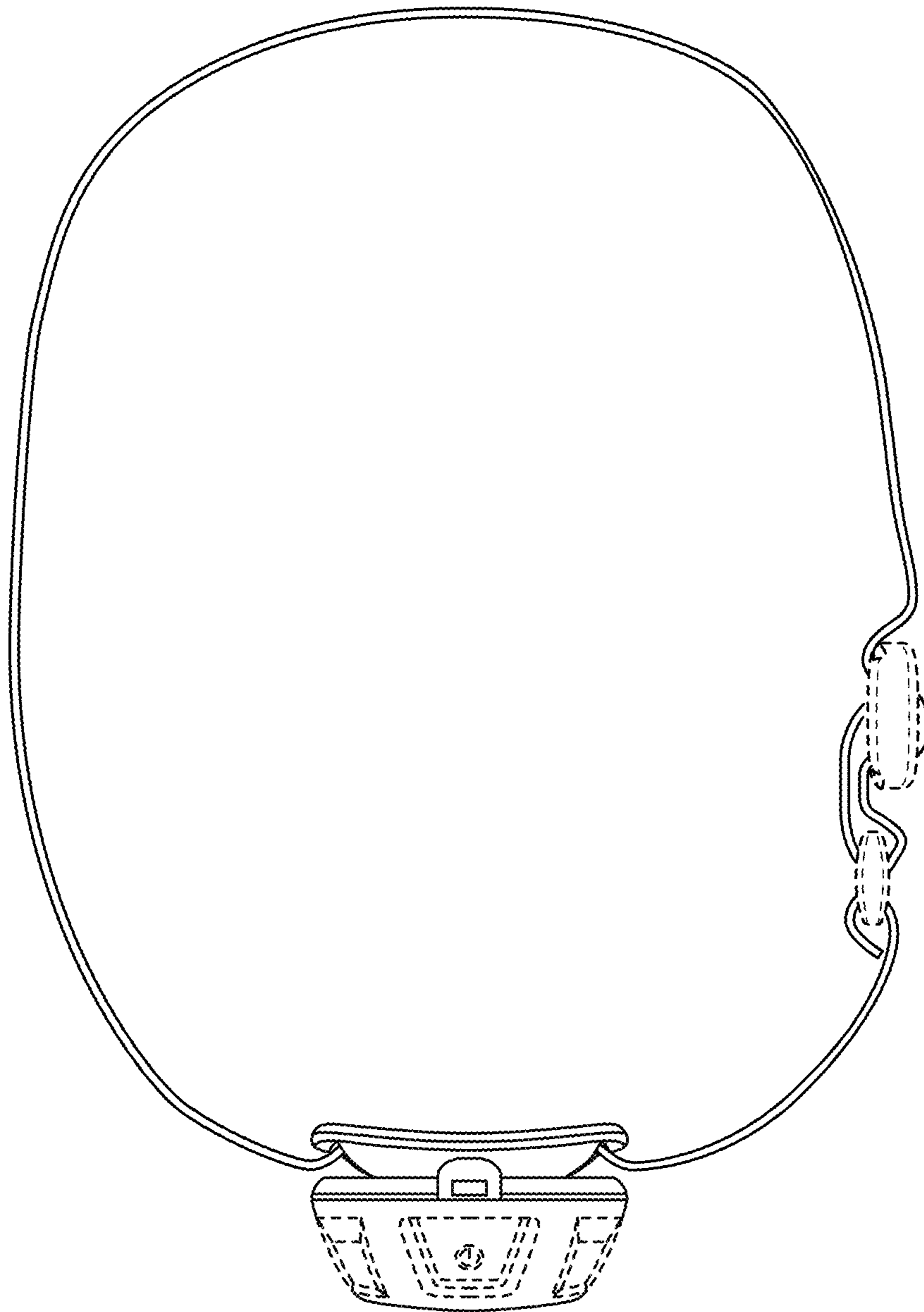

FIG. 6

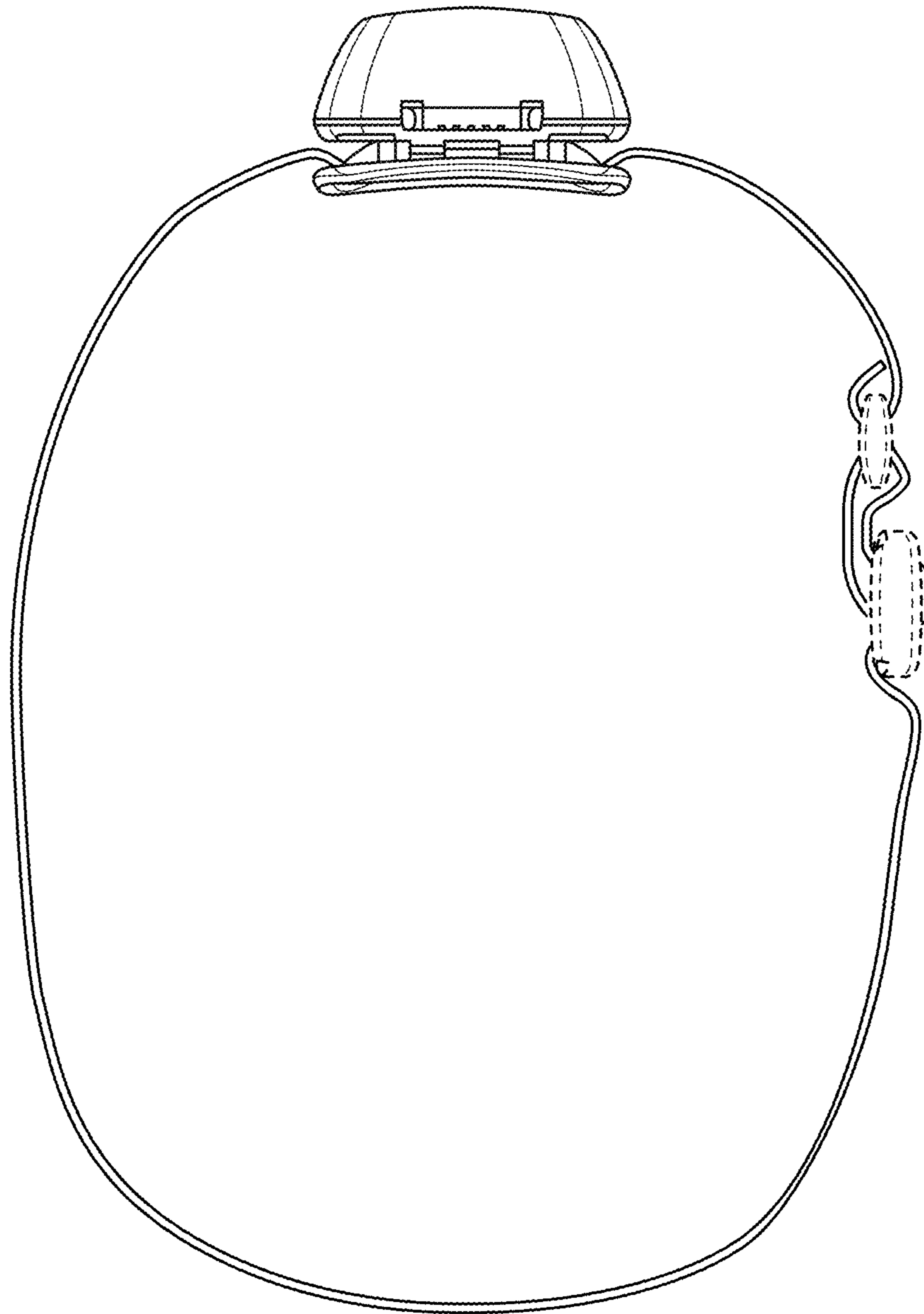

FIG. 7