



US00D801880S

(12) **United States Design Patent** (10) **Patent No.:** **US D801,880 S**
Ahlbertz (45) **Date of Patent:** **** Nov. 7, 2017**

(54) **HYGIENE CHAIR** 2008/0087481 A1* 4/2008 Grymko A61G 5/042
180/68.5

(71) Applicant: **Gate Rehab Development AB**, Reftele (SE) * cited by examiner

(72) Inventor: **Anders Ahlbertz**, Gothenburg (SE) *Primary Examiner* — Charles Hanson
(74) *Attorney, Agent, or Firm* — Brooks Kushman P.C.

(73) Assignee: **GATE REHAB DEVELOPMENT AB**, Reftele (SE) (57) **CLAIM**
The ornamental design for a hygiene chair, as shown and described.

(**) Term: **15 Years**

DESCRIPTION

(21) Appl. No.: **29/542,468**

FIG. 1 is a front-right-side perspective view of a hygiene chair;

(22) Filed: **Oct. 14, 2015**

FIG. 2 is a front-left-side perspective view of the hygiene chair of FIG. 1; and

(30) **Foreign Application Priority Data**

Apr. 14, 2015 (EM) 002680769-0001

FIG. 3 is a front perspective view of the hygiene chair of FIG. 1;

(51) **LOC (10) Cl.** **12-12**

FIG. 4 is a rear perspective view of the hygiene chair of FIG. 1;

(52) **U.S. Cl.**
USPC **D12/131**

FIG. 5 is a top perspective view of the hygiene chair of FIG. 1;

(58) **Field of Classification Search**
USPC D12/128–133
CPC A61G 5/04; A61G 5/041–5/047; A61G 2005/048

FIG. 6 is a right-side perspective view of the hygiene chair of FIG. 1;

See application file for complete search history.

FIG. 7 is a left-side perspective view of the hygiene chair of FIG. 1;

(56) **References Cited**

U.S. PATENT DOCUMENTS

- 5,112,076 A * 5/1992 Wilson A61G 5/045
180/907
- 5,383,709 A * 1/1995 Chaney A61G 5/14
297/302.2
- D360,172 S * 7/1995 Francke D12/128
- D439,869 S * 4/2001 Kjell D12/128
- D475,952 S * 6/2003 Nelson D12/131
- D604,208 S * 11/2009 Perk D12/131
- D745,441 S * 12/2015 Ohruh D12/131

FIG. 8 is a front-right-side perspective view of the hygiene chair in a lowered position;

FIG. 9 is a front-left-side perspective view of the hygiene chair of FIG. 8; and

FIG. 10 is a rear perspective view of the hygiene chair of FIG. 8;

FIG. 11 is a top perspective view of the hygiene chair of FIG. 8;

FIG. 12 is a right-side perspective view of the hygiene chair of FIG. 8; and,

FIG. 13 is a left-side perspective view of the hygiene chair of FIG. 8.

The broken lines are for illustrative purposes only and form no part of the claimed design.

1 Claim, 13 Drawing Sheets

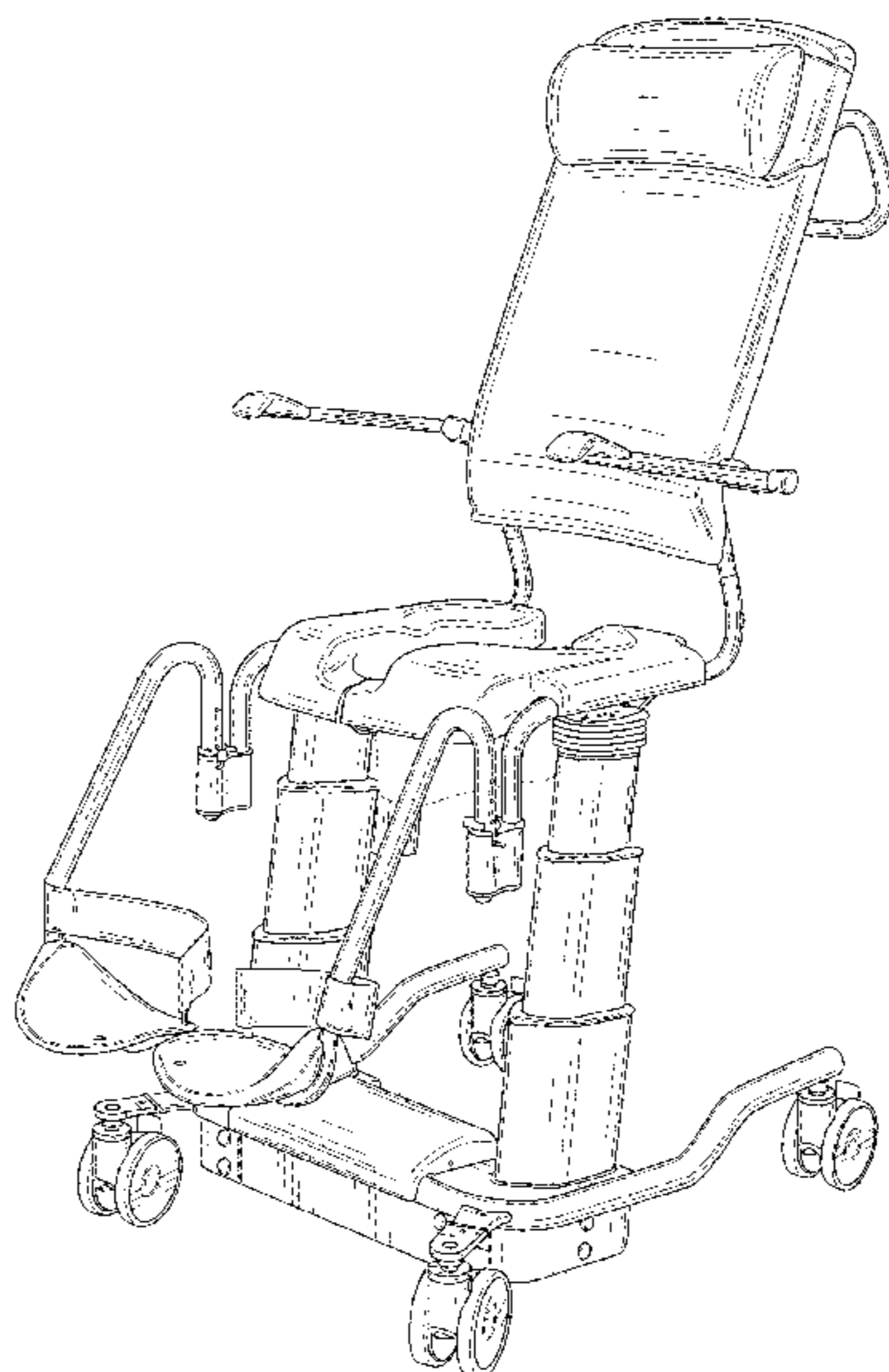

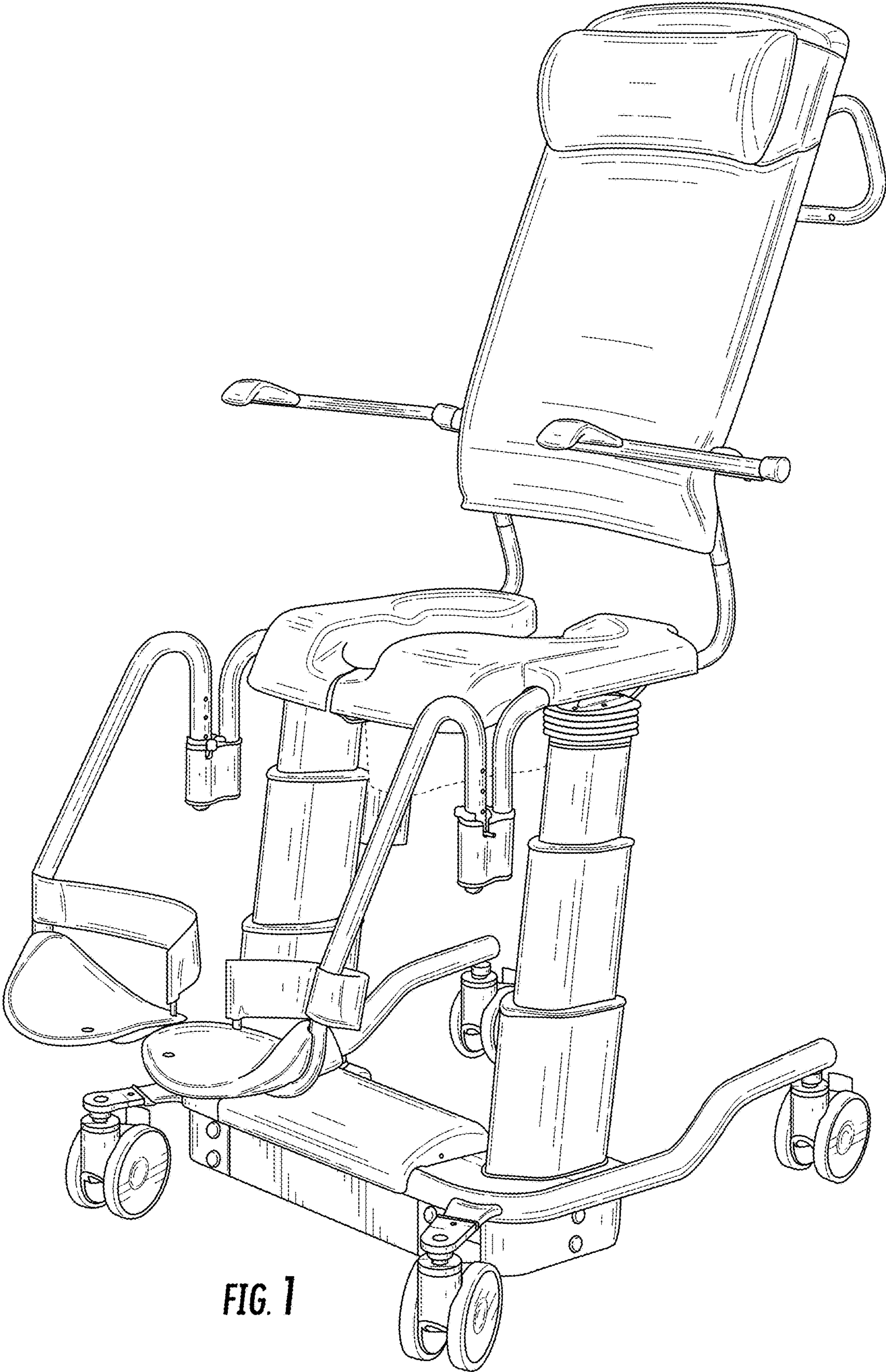

FIG. 1

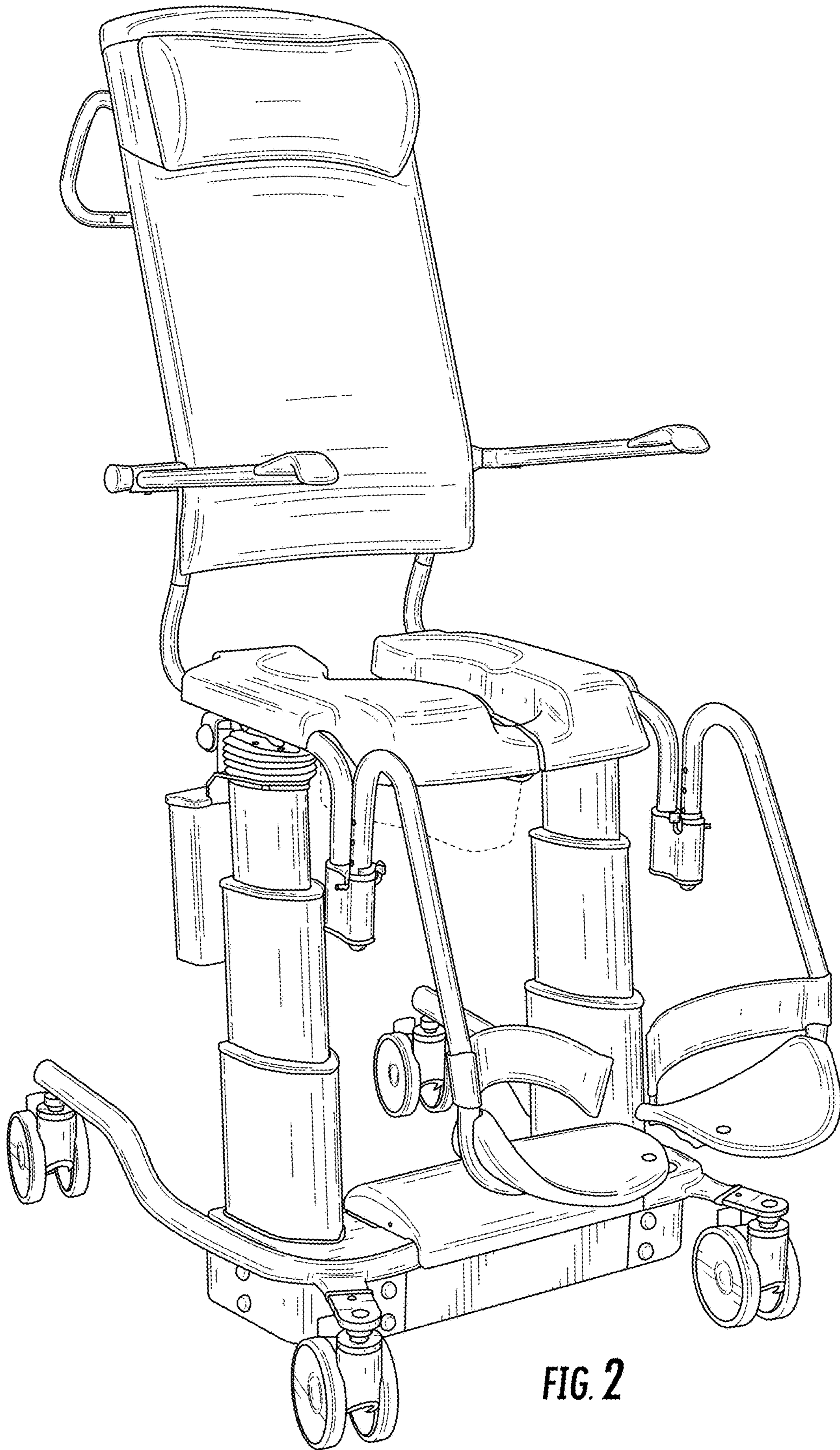

FIG. 2

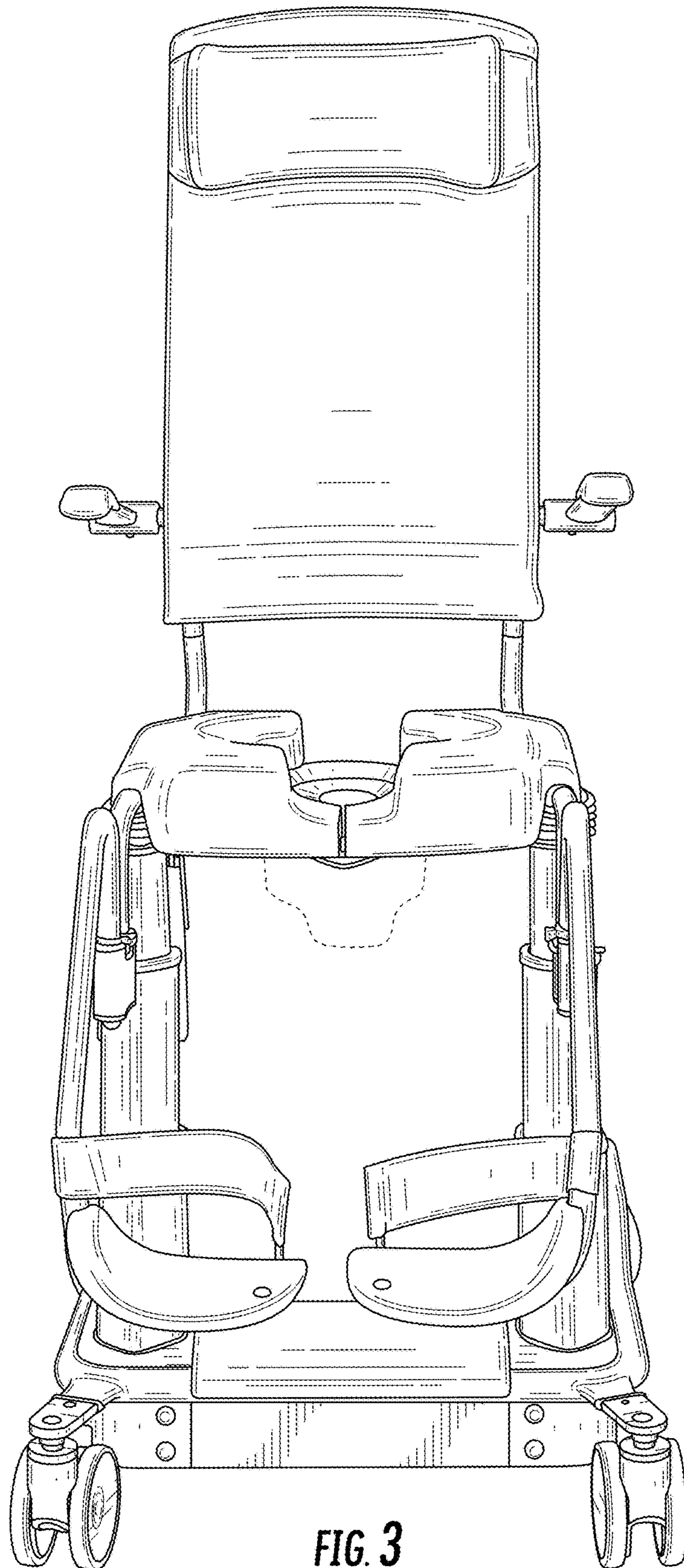

FIG. 3

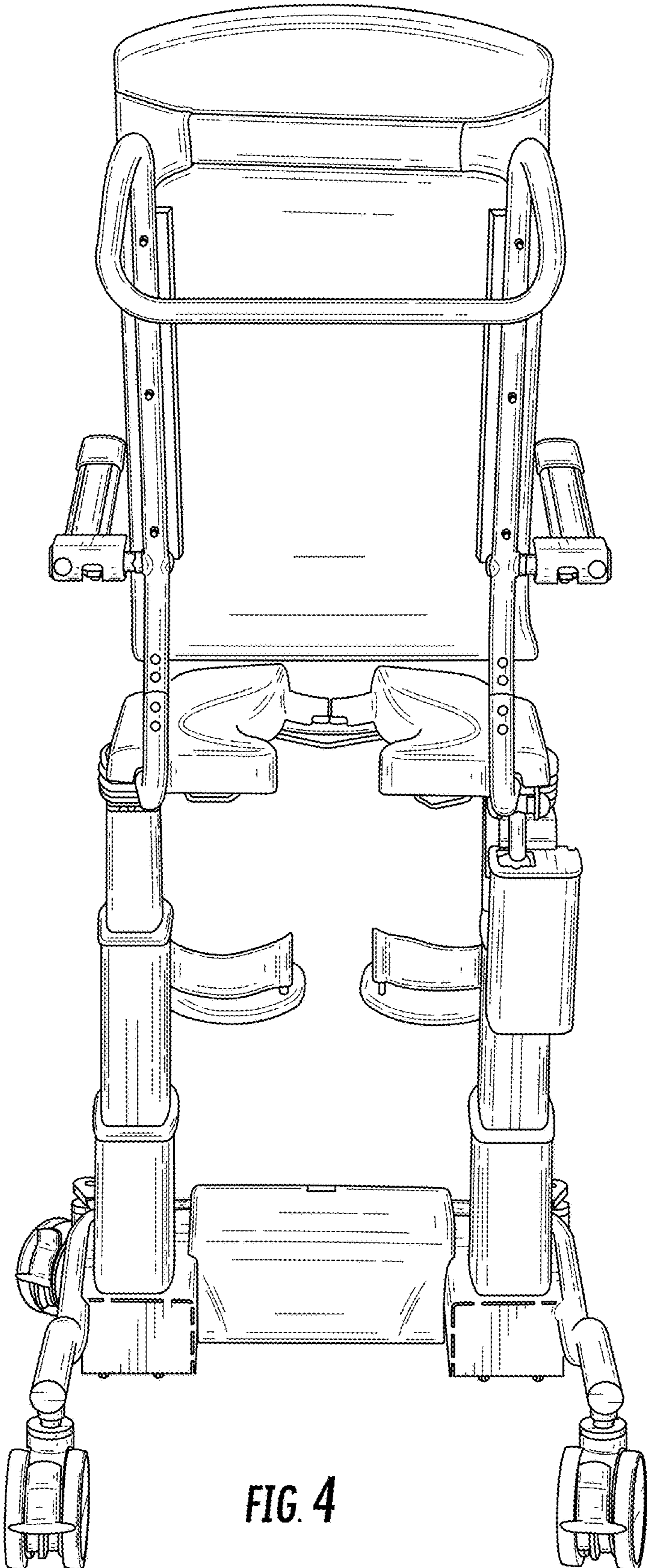

FIG. 4

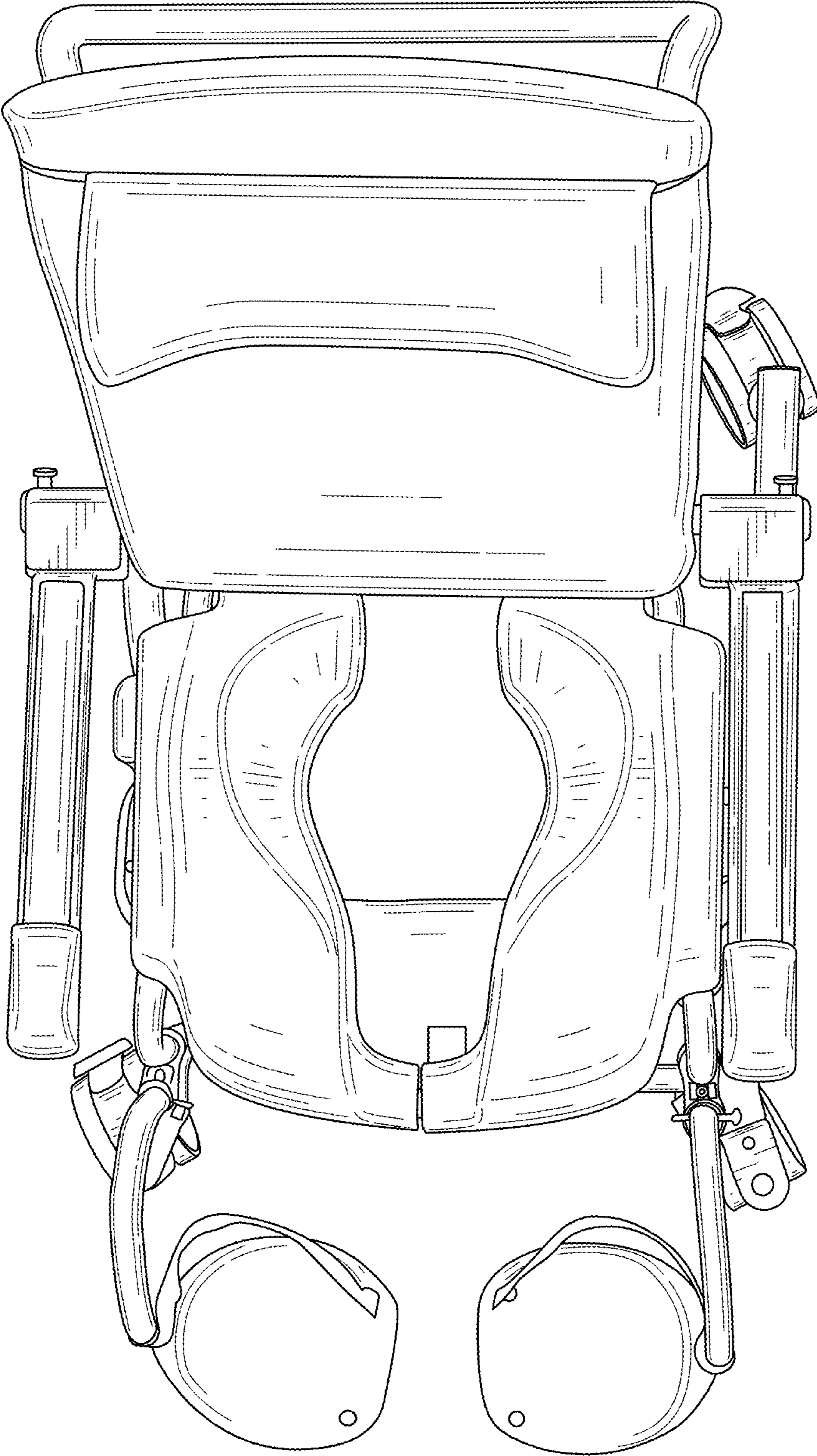

FIG. 5

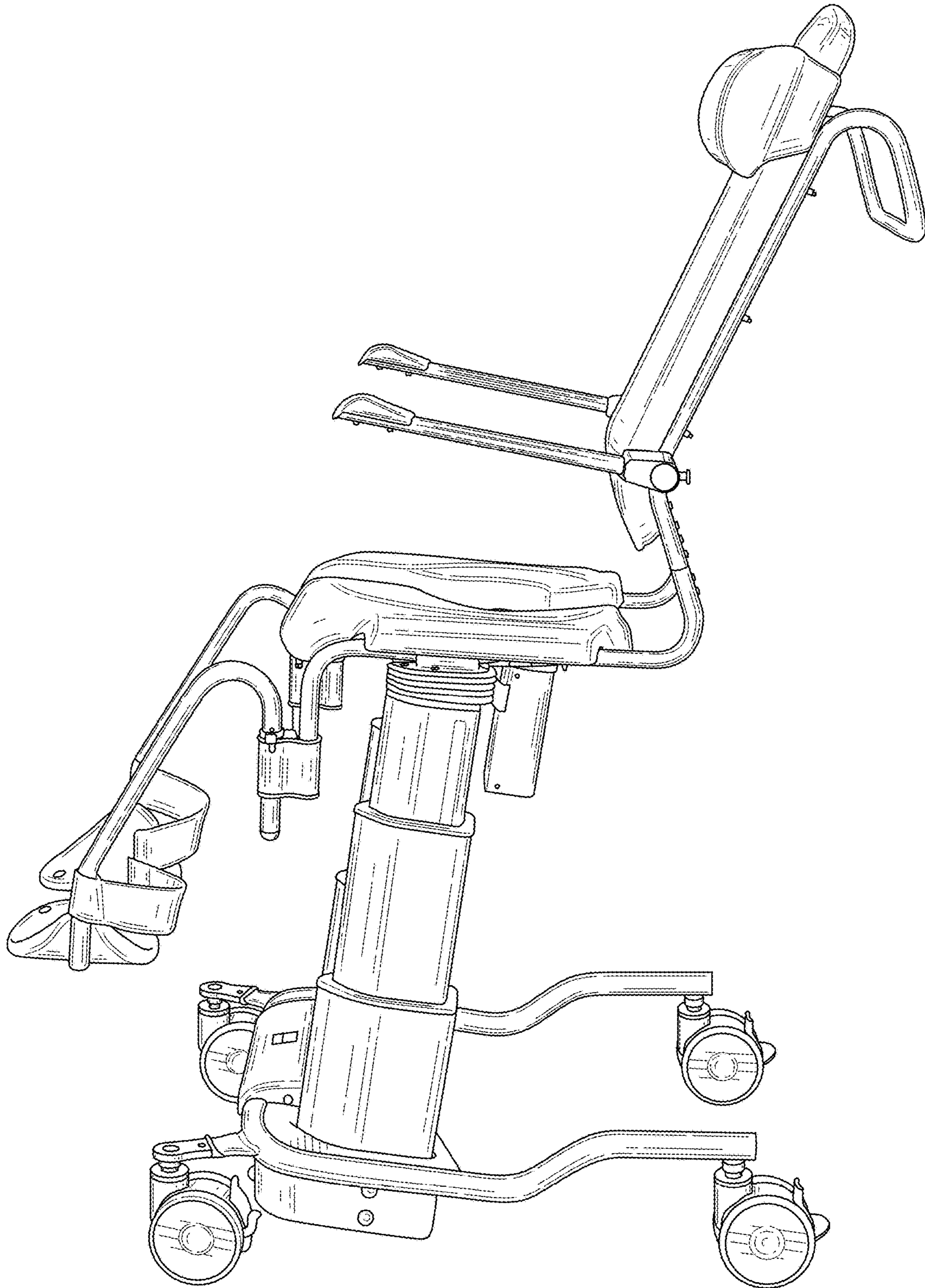

FIG. 6

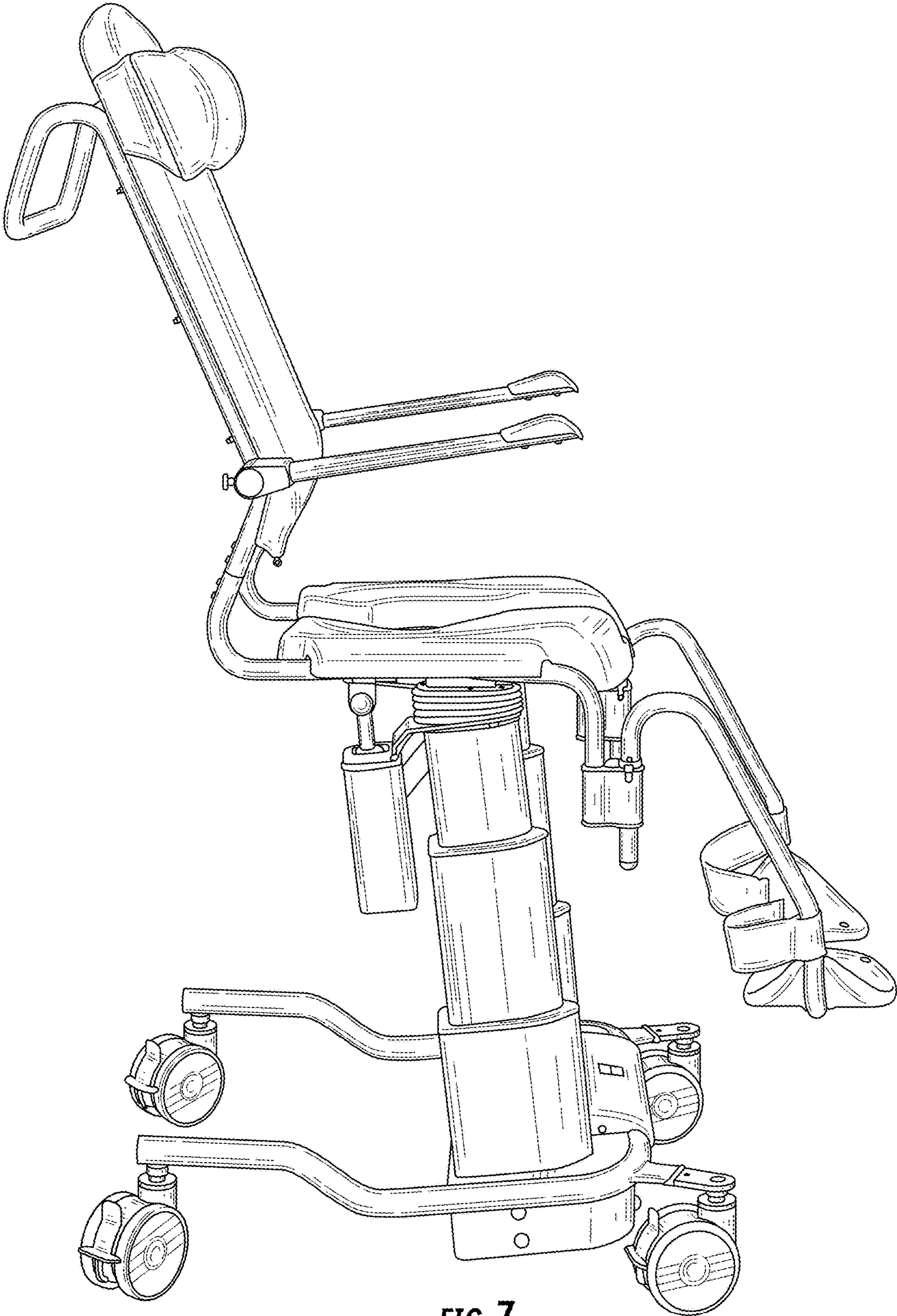

FIG. 7

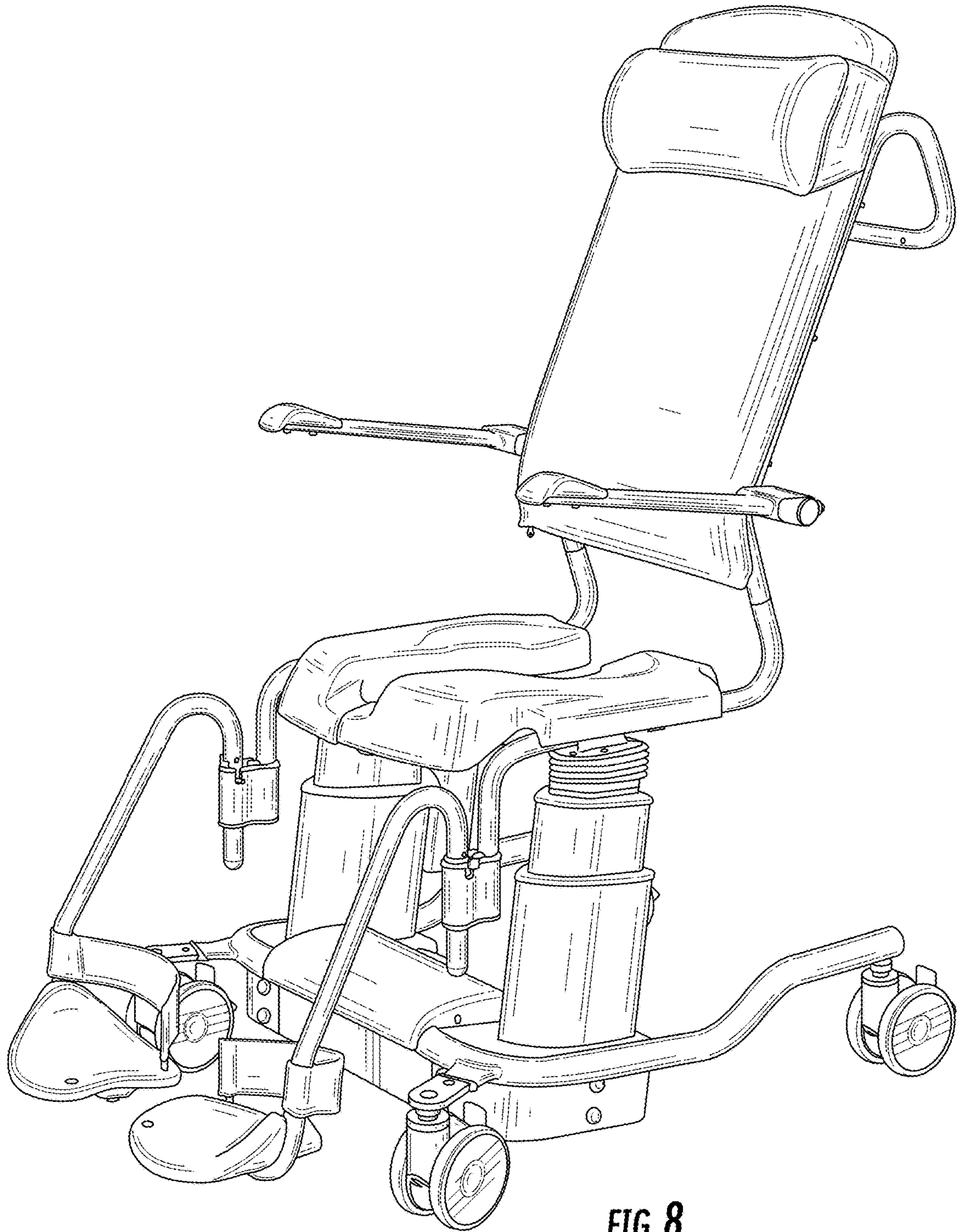

FIG. 8

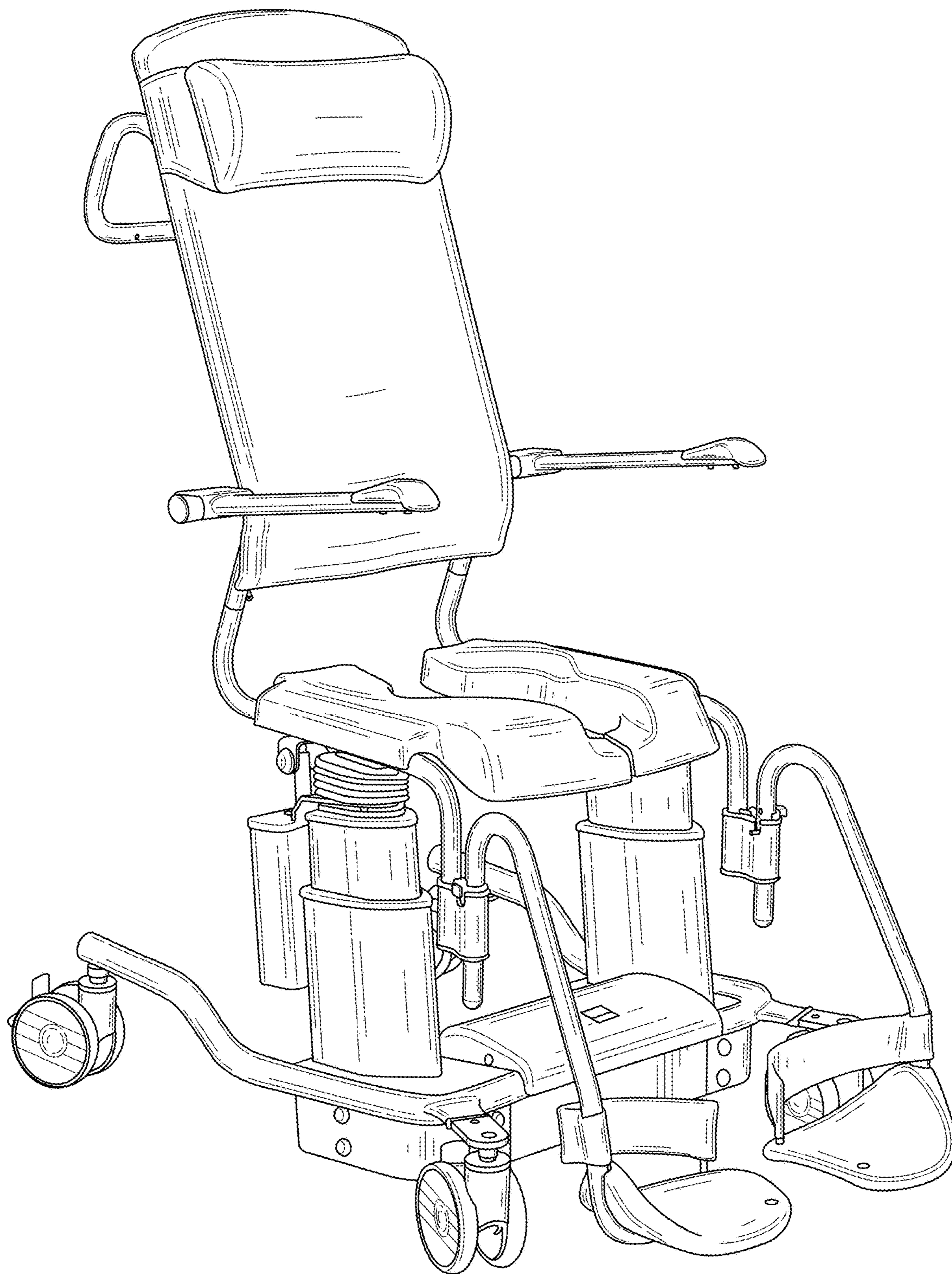

FIG. 9

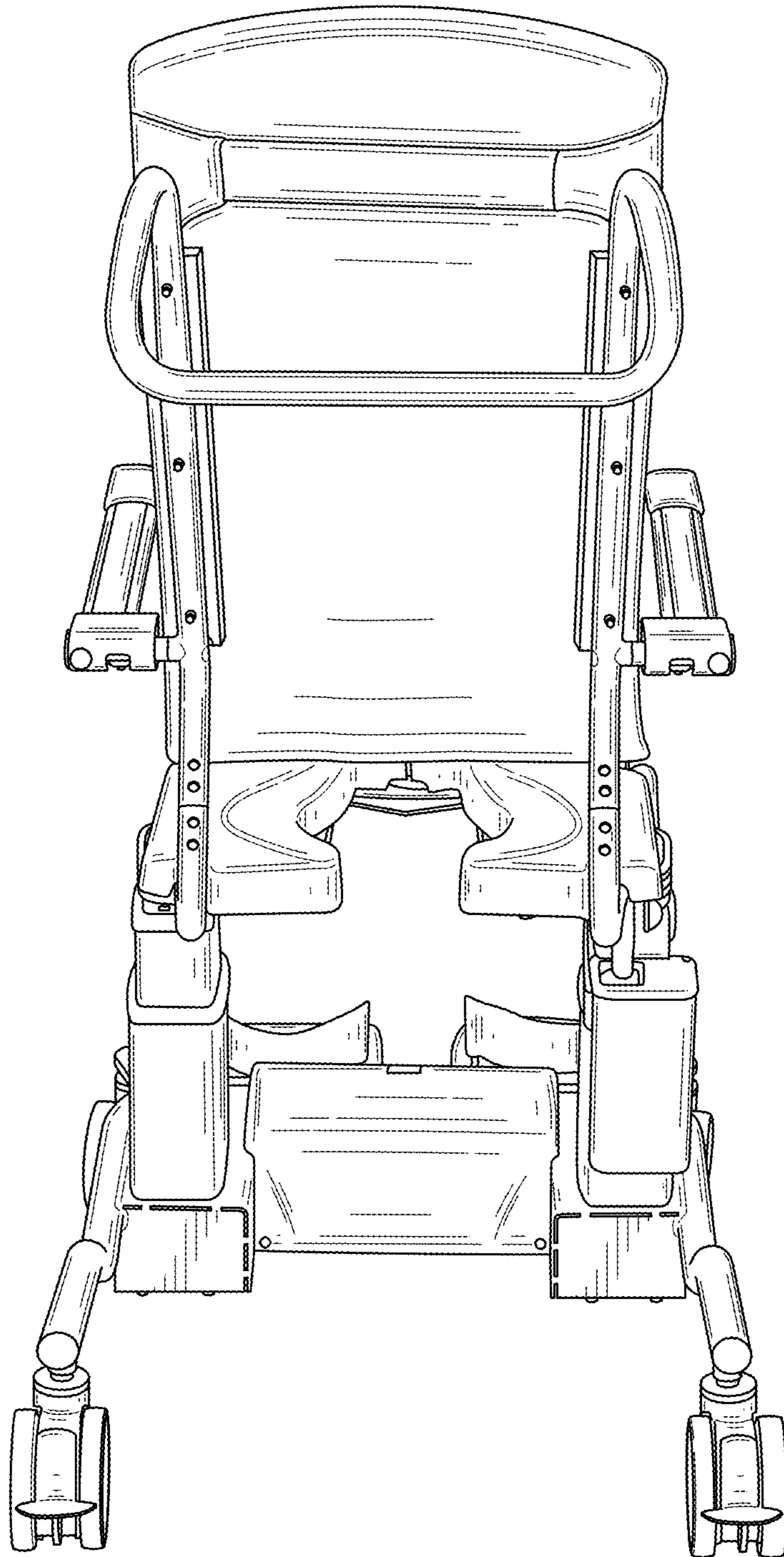

FIG. 10

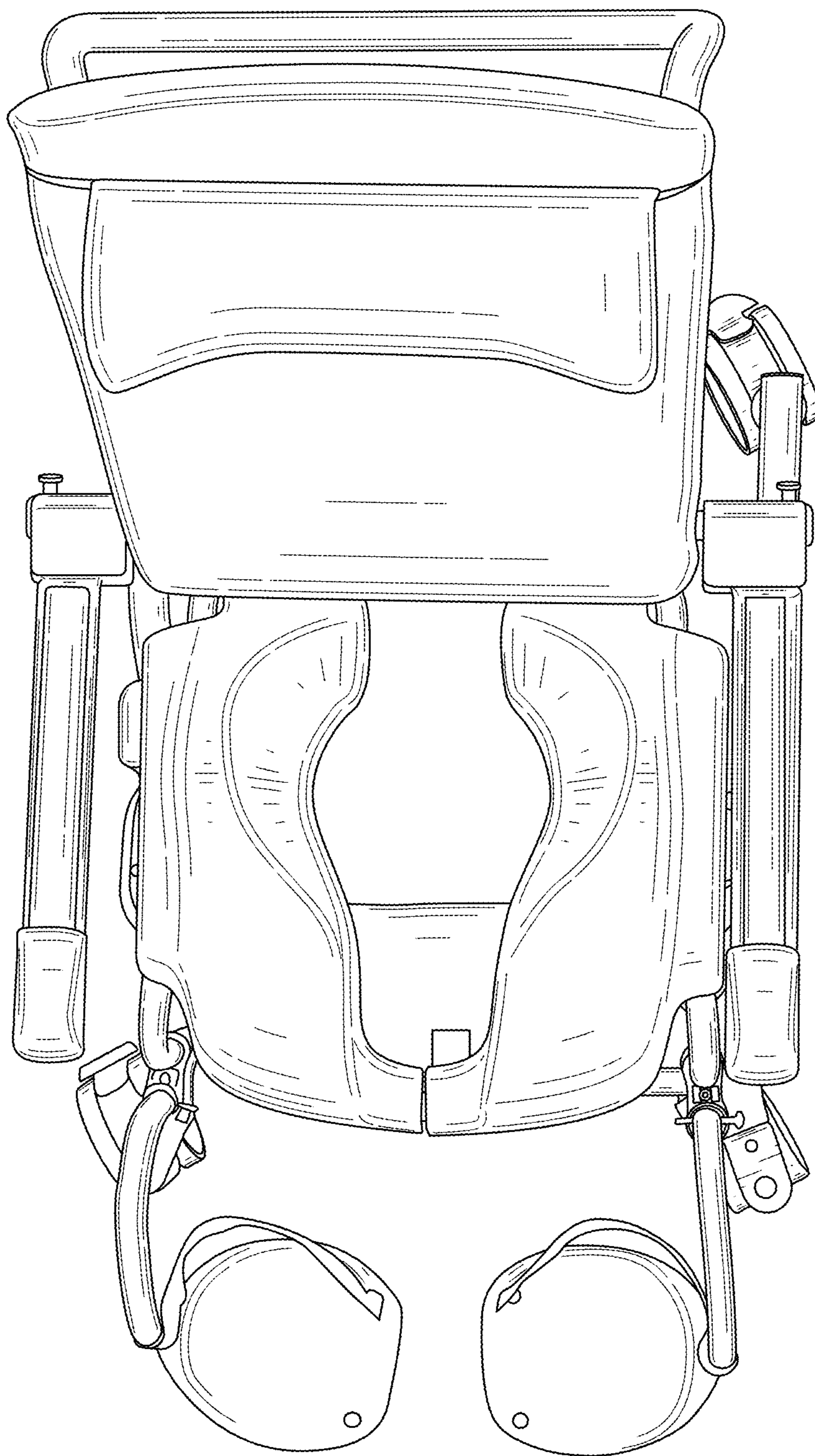

FIG. 11

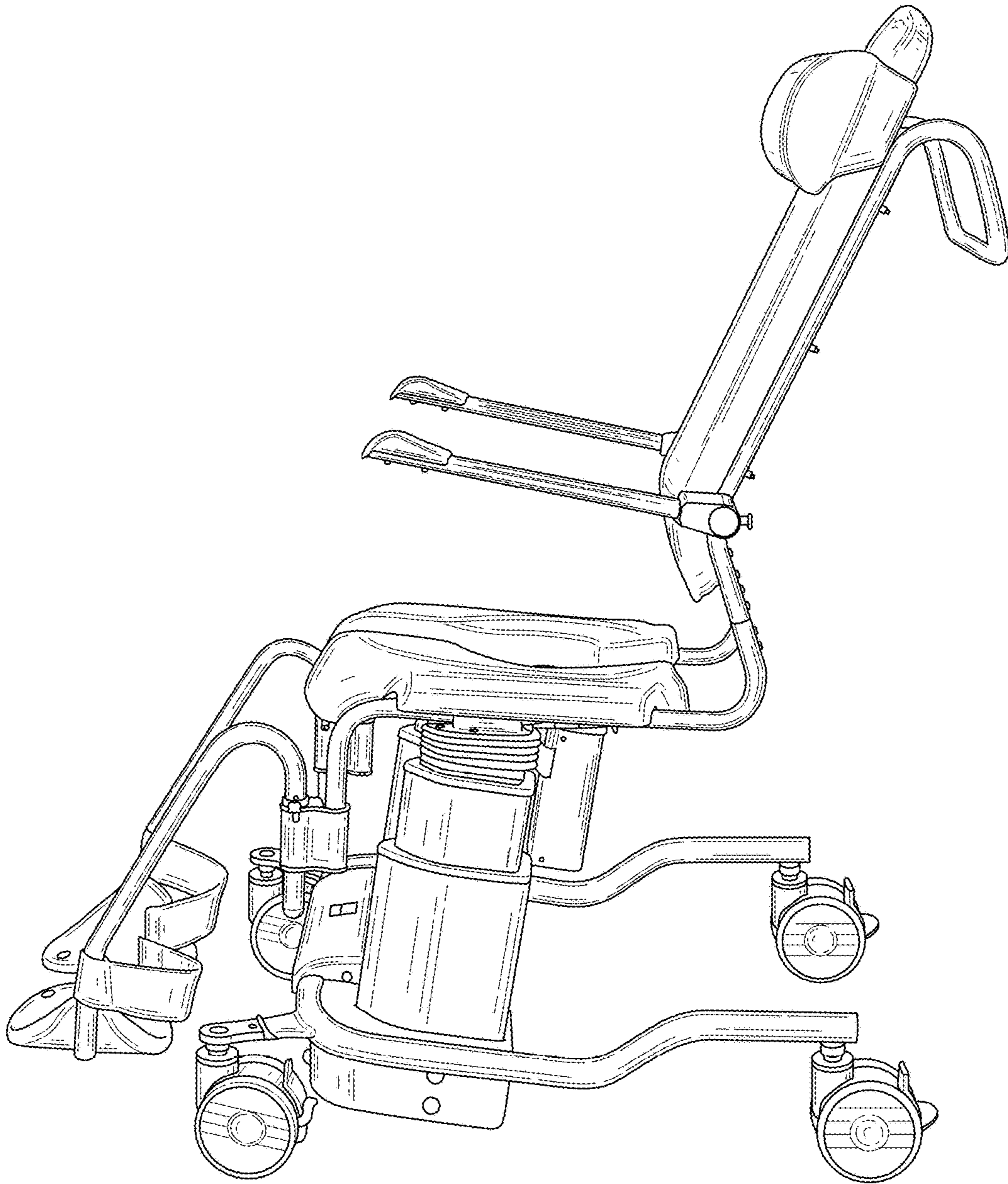

FIG. 12

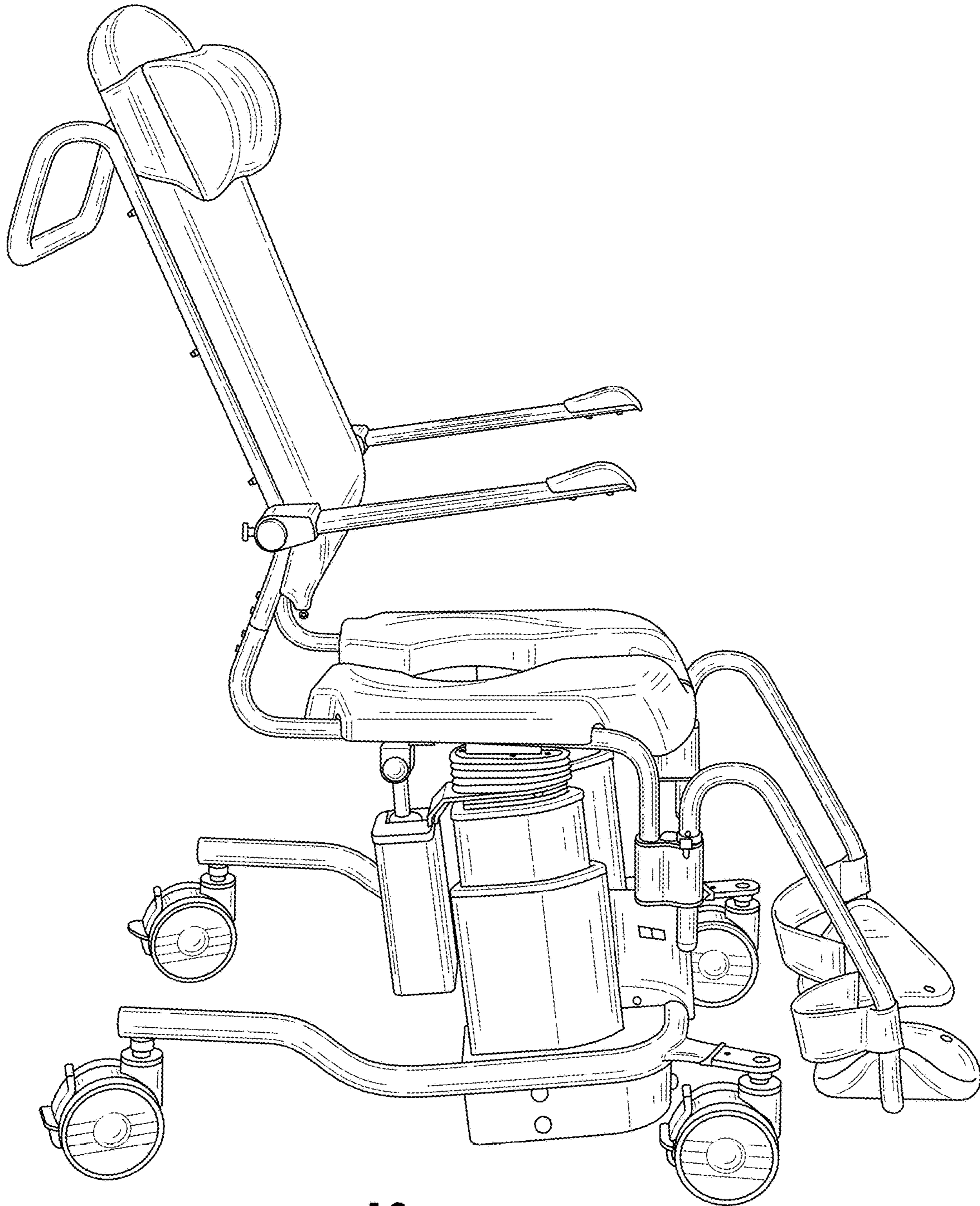

FIG. 13