



US00D801833S

(12) **United States Design Patent** (10) **Patent No.:** **US D801,833 S**  
**Jiang et al.** (45) **Date of Patent:** **\*\* Nov. 7, 2017**

(54) **ROOM CONTROL UNIT**

(71) Applicant: **Siemens Schweiz AG**, Zurich (CH)

(72) Inventors: **Cai Wei Jiang**, Shenzhen (CN); **Jonas Vollmer**, Erlangen (DE); **Hui Lin Chen**, Beijing (CN); **Yun Yun Zhu**, Shenzhen (CN)

(73) Assignee: **SIEMENS SCHWEIZ AB**, Zurich (CH)

(\*\*) Term: **15 Years**

(21) Appl. No.: **29/563,641**

(22) Filed: **May 6, 2016**

(30) **Foreign Application Priority Data**

Nov. 6, 2015 (WO) ..... DM/088823  
Apr. 19, 2016 (EM) ..... 003074640

(51) **LOC (10) Cl.** ..... **10-04**

(52) **U.S. Cl.**  
USPC ..... **D10/50; D13/162.1**

(58) **Field of Classification Search**  
USPC ..... D10/49, 50; D13/162, 162.1; D14/358  
CPC . F23N 5/20; F23N 5/203; F23N 5/206; F23N 5/18; F23N 5/184; F23N 5/187; F23N 5/22; F23N 2025/12; F23N 2041/02; F24F 11/00; F24F 11/0012; F24F 11/0009; F24F 11/001; F24F 2011/0057; F24F 2011/0073; F24F 2011/0091

See application file for complete search history.

(56) **References Cited**

U.S. PATENT DOCUMENTS

8,498,103	B2 *	7/2013	Graneto, III	.....	G06F 1/1656 206/320
9,310,095	B2 *	4/2016	Adamik	.....	H05K 1/111
D758,217	S *	6/2016	Kumfer	.....	D10/50
D780,605	S *	3/2017	Chen	.....	D10/49
9,669,932	B2 *	6/2017	Murata	.....	B64D 11/06

\* cited by examiner

*Primary Examiner* — Antoine D Davis

(74) *Attorney, Agent, or Firm* — Slayden Grubert Beard PLLC

(57) **CLAIM**

The ornamental design for a room control unit, as shown and described.

**DESCRIPTION**

FIG. 1 illustrates a front elevational view of a control;  
FIG. 2 illustrates a back elevational view of a control;  
FIG. 3 illustrates a top elevational view of a control;  
FIG. 4 illustrates a bottom elevational view of a control;  
FIG. 5 illustrates a right side elevational view of a control;  
FIG. 6 illustrates a left side elevational view of a control;  
and,  
FIG. 7 illustrates a top right perspective view of a control.

**1 Claim, 7 Drawing Sheets**

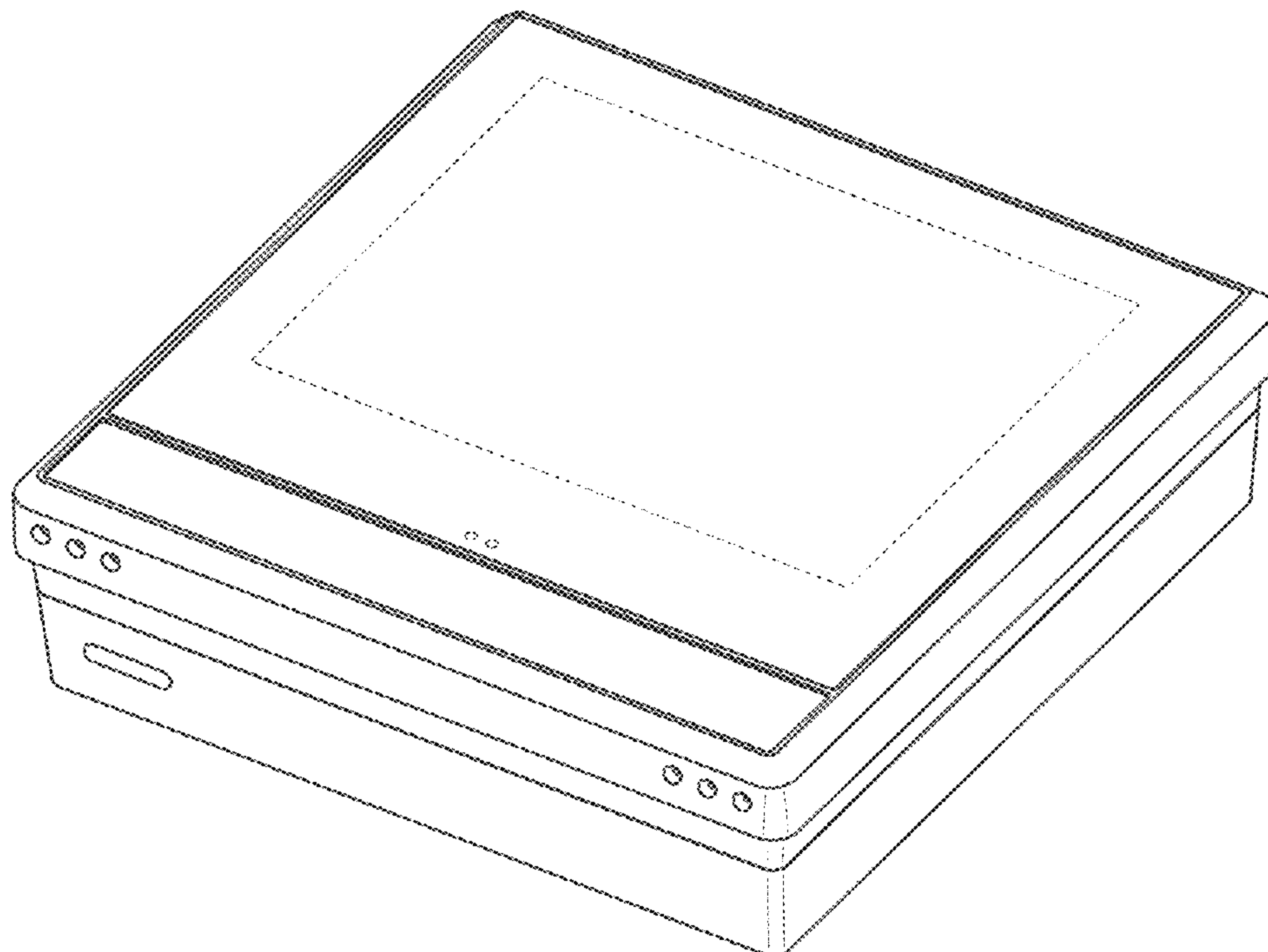

FIG 1

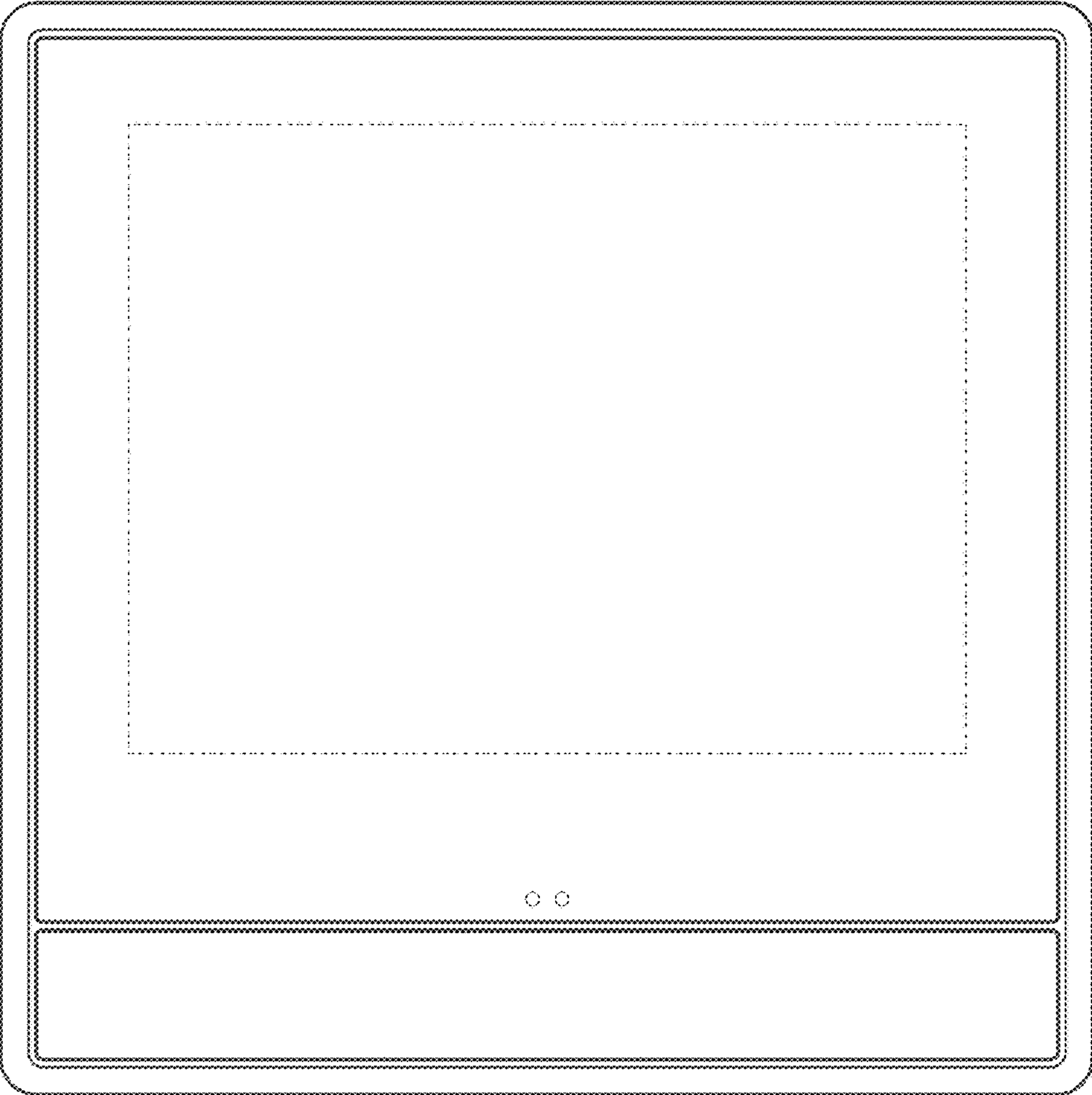

FIG 2

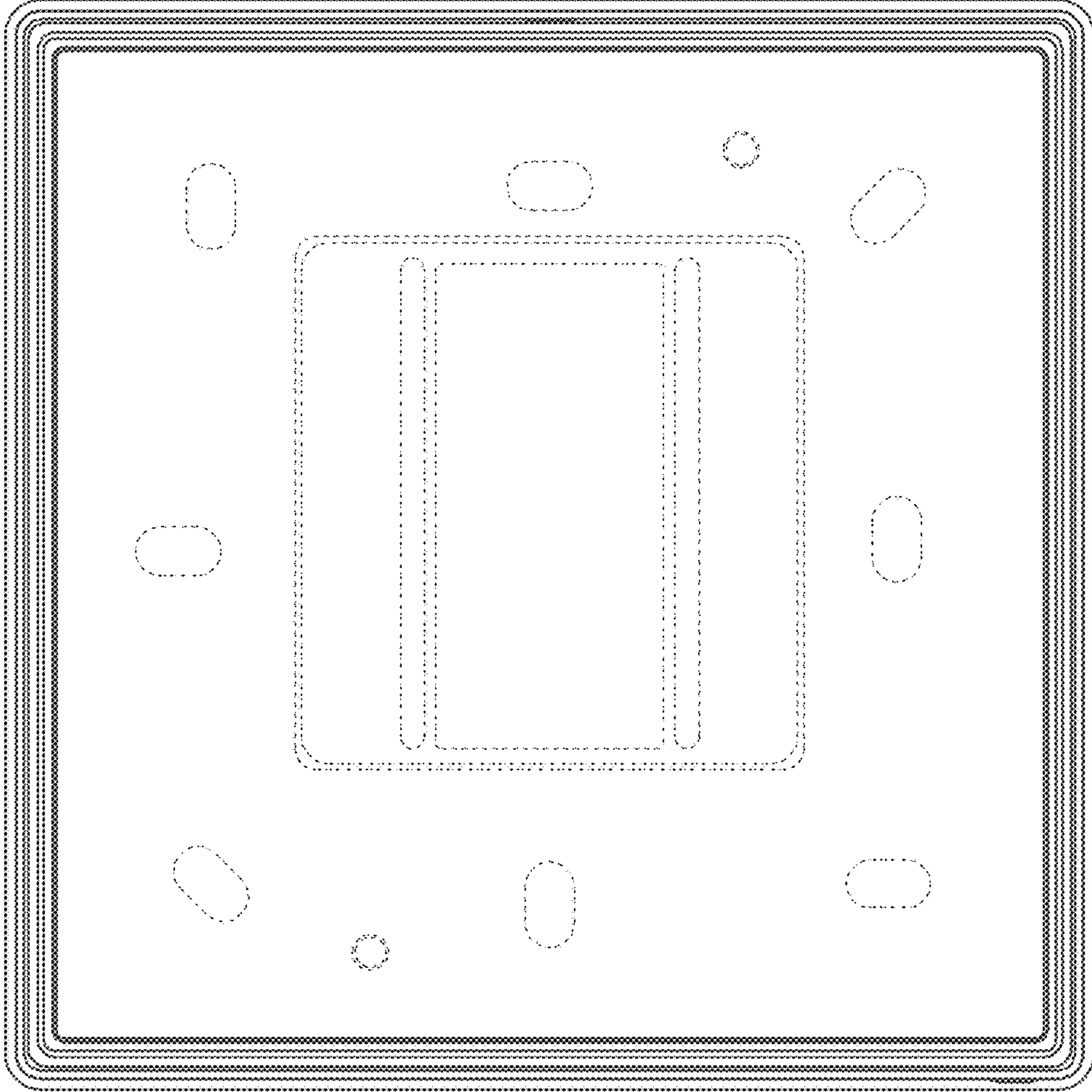

FIG 3

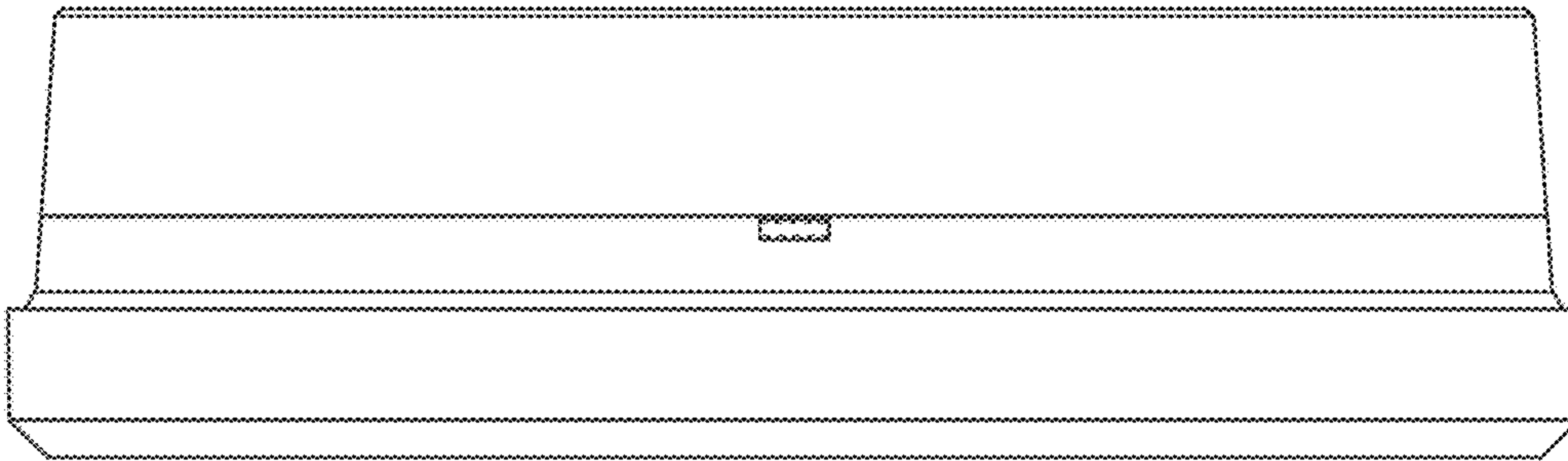

FIG 4

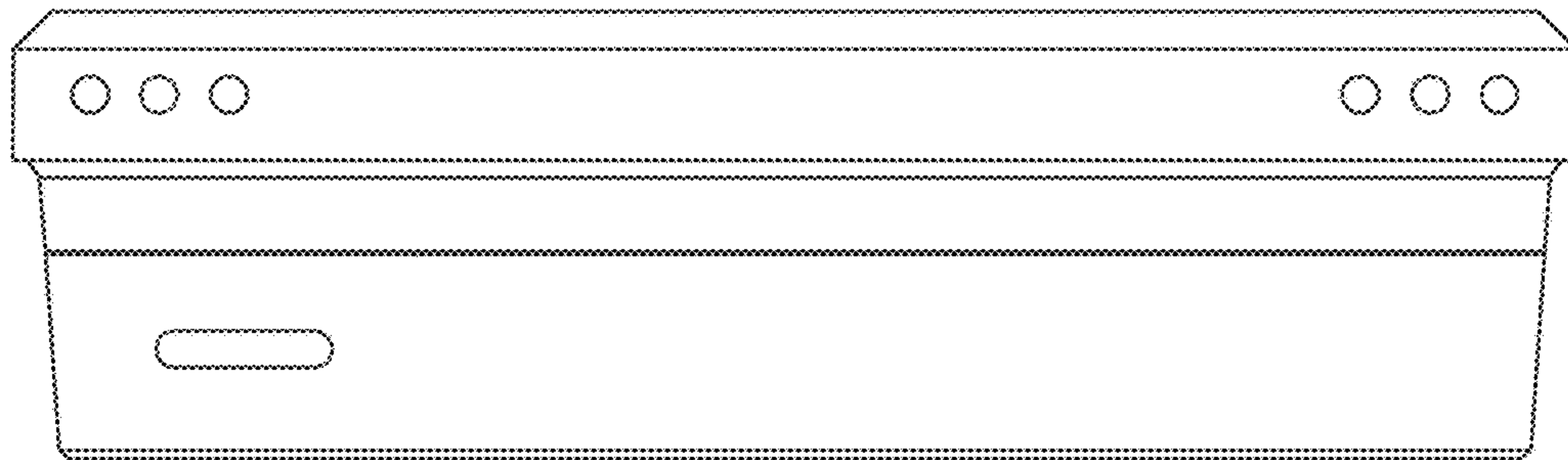



FIG 5

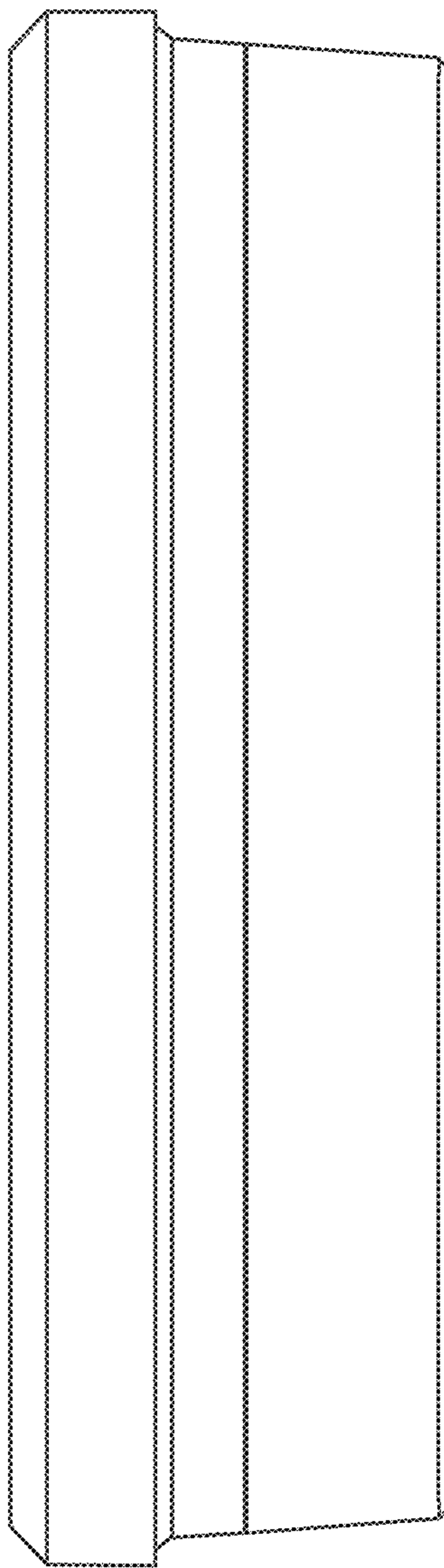

FIG 6

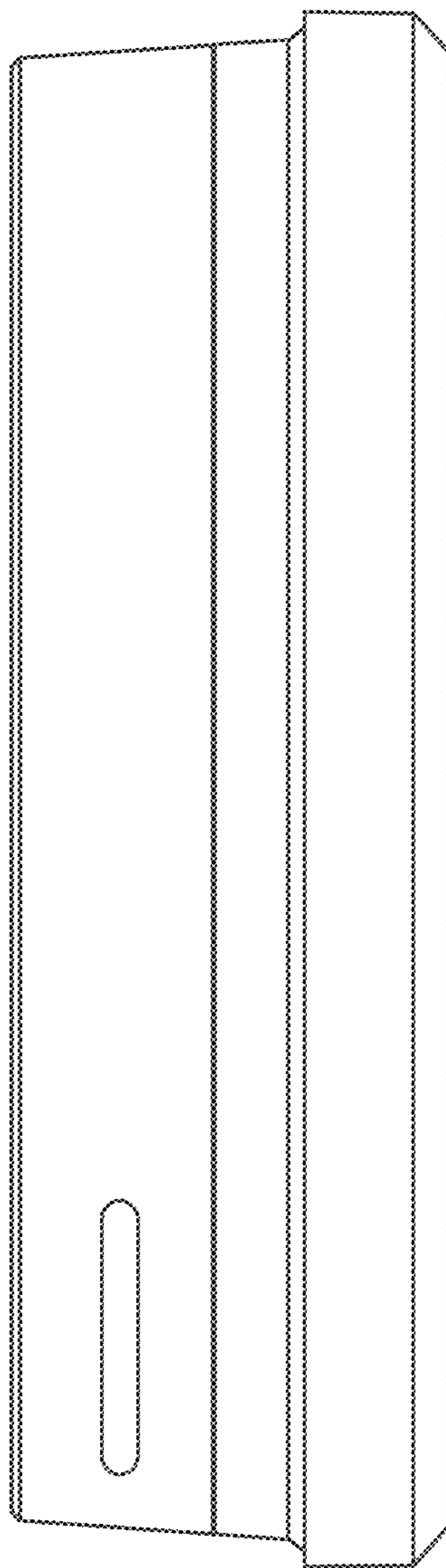

FIG 7

