



US00D801680S

(12) **United States Design Patent** (10) **Patent No.:** **US D801,680 S**
Rogers et al. (45) **Date of Patent:** **** Nov. 7, 2017**

(54) **SPORTS CAP HANDBAG**

D534,347 S * 1/2007 Prentice D3/238
D771,913 S * 11/2016 Hernandez, Jr. D2/882
D772,540 S * 11/2016 Hernandez, Jr. D2/882

(71) Applicants: **Camille Lashae Rogers**, Las Vegas,
NV (US); **Steven Deron Washington**,
Las Vegas, NV (US)

* cited by examiner

(72) Inventors: **Camille Lashae Rogers**, Las Vegas,
NV (US); **Steven Deron Washington**,
Las Vegas, NV (US)

Primary Examiner — Holly H Baynham
(74) *Attorney, Agent, or Firm* — Dunlap Bennett &
Ludwig PLLC

(**) Term: **15 Years**

(57) **CLAIM**

(21) Appl. No.: **29/582,151**

The ornamental design for a sports cap handbag, as shown and described.

(22) Filed: **Oct. 25, 2016**

DESCRIPTION

(51) **LOC (10) Cl.** **03-01**

(52) **U.S. Cl.**

USPC **D3/238**; D3/234

(58) **Field of Classification Search**

USPC D3/234, 238

CPC A45C 1/024; A45C 3/06

See application file for complete search history.

FIG. 1 is a top front perspective view of a sports cap handbag showing my new design;
FIG. 2 is a left elevation view, with the right elevation view being a mirror image thereof;
FIG. 3 is a front elevation view thereof;
FIG. 4 is a rear elevation view thereof;
FIG. 5 is a top plan view thereof; and,
FIG. 6 is a bottom plan view thereof.

The broken lines shown in the drawings illustrate portions of the sports cap handbag that form no part of the claimed design.

(56) **References Cited**

U.S. PATENT DOCUMENTS

D460,604 S * 7/2002 Sullivan, Jr. D2/882

D504,003 S * 4/2005 Lee D2/882

1 Claim, 4 Drawing Sheets

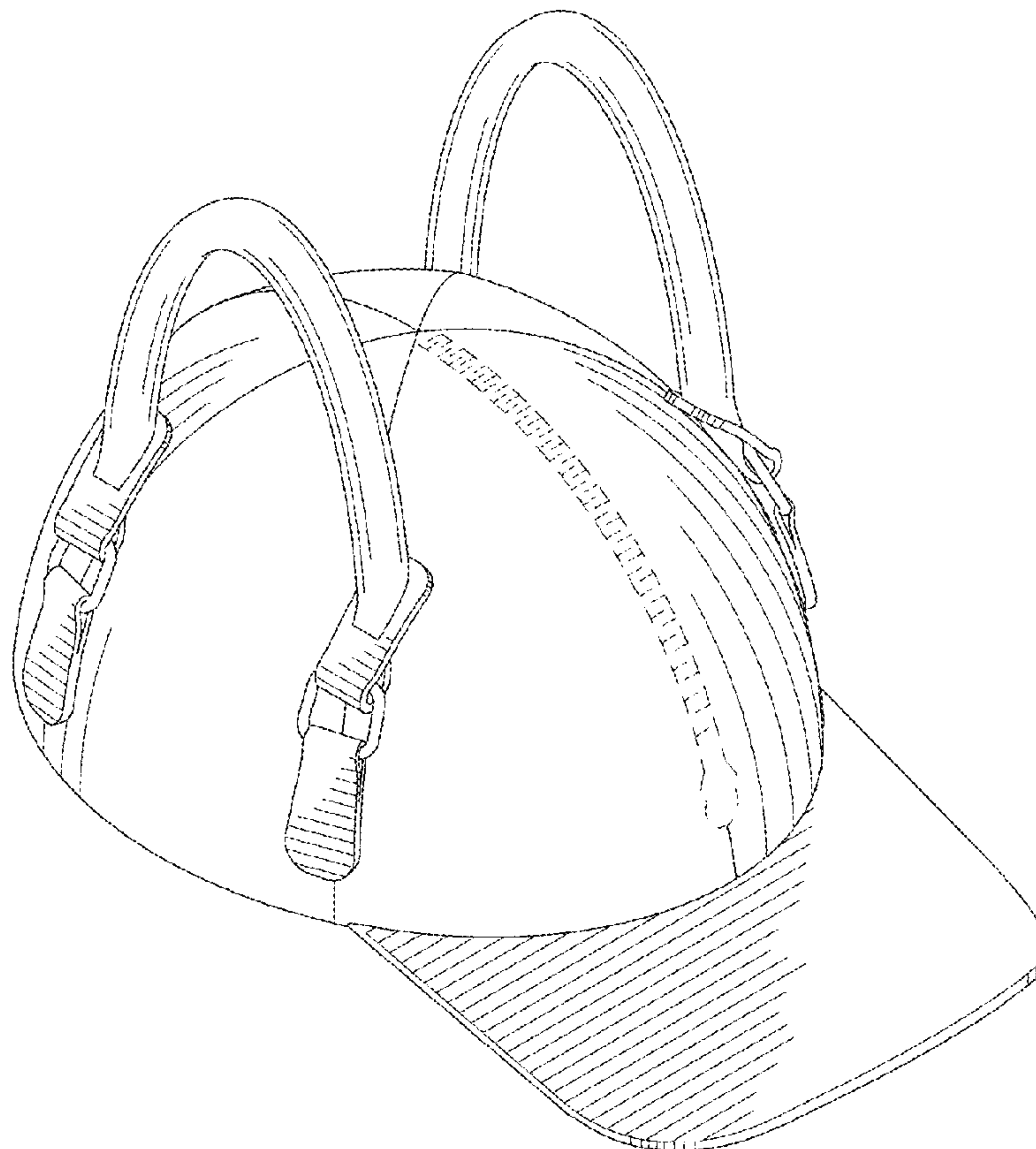

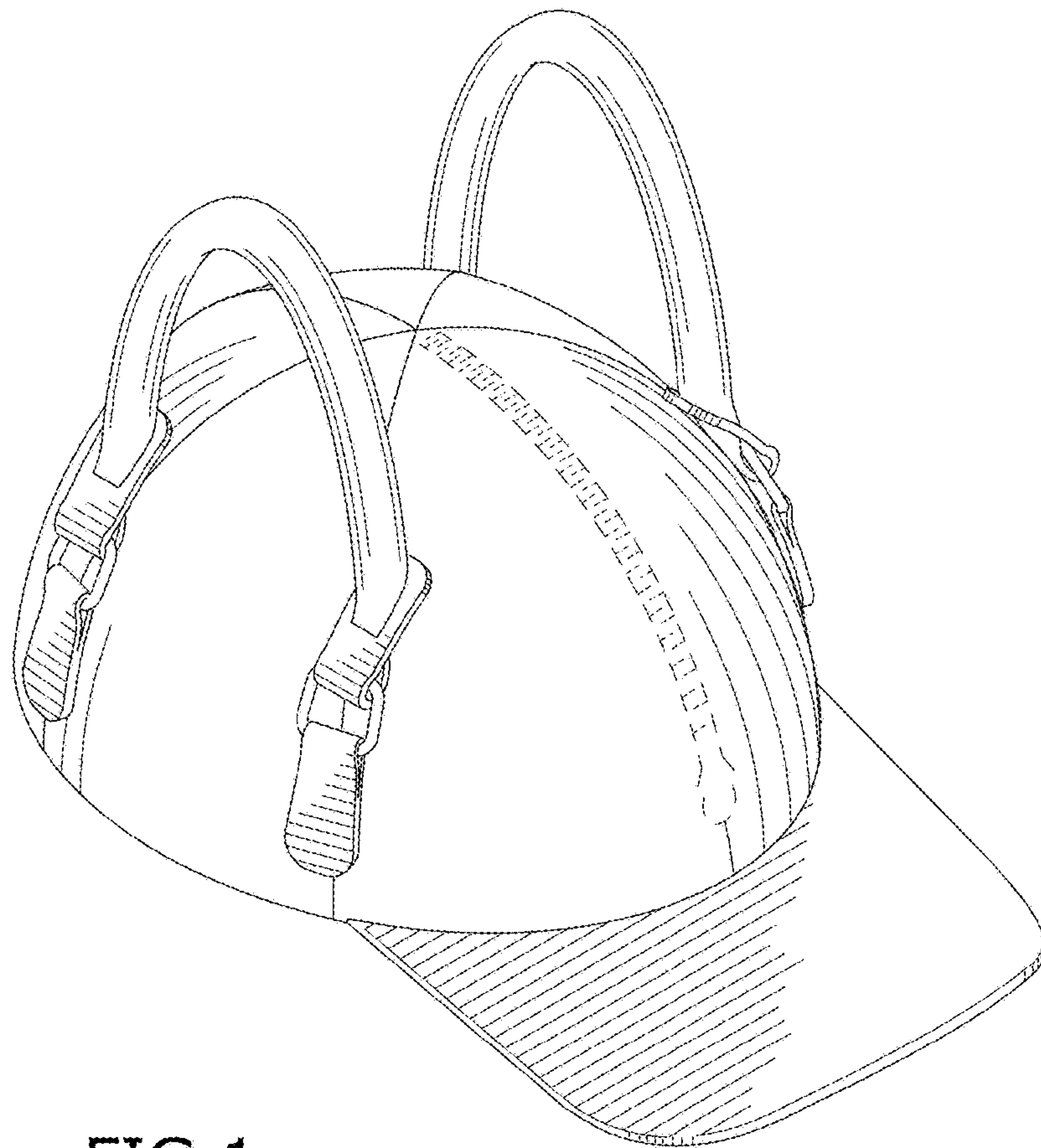

FIG. 1

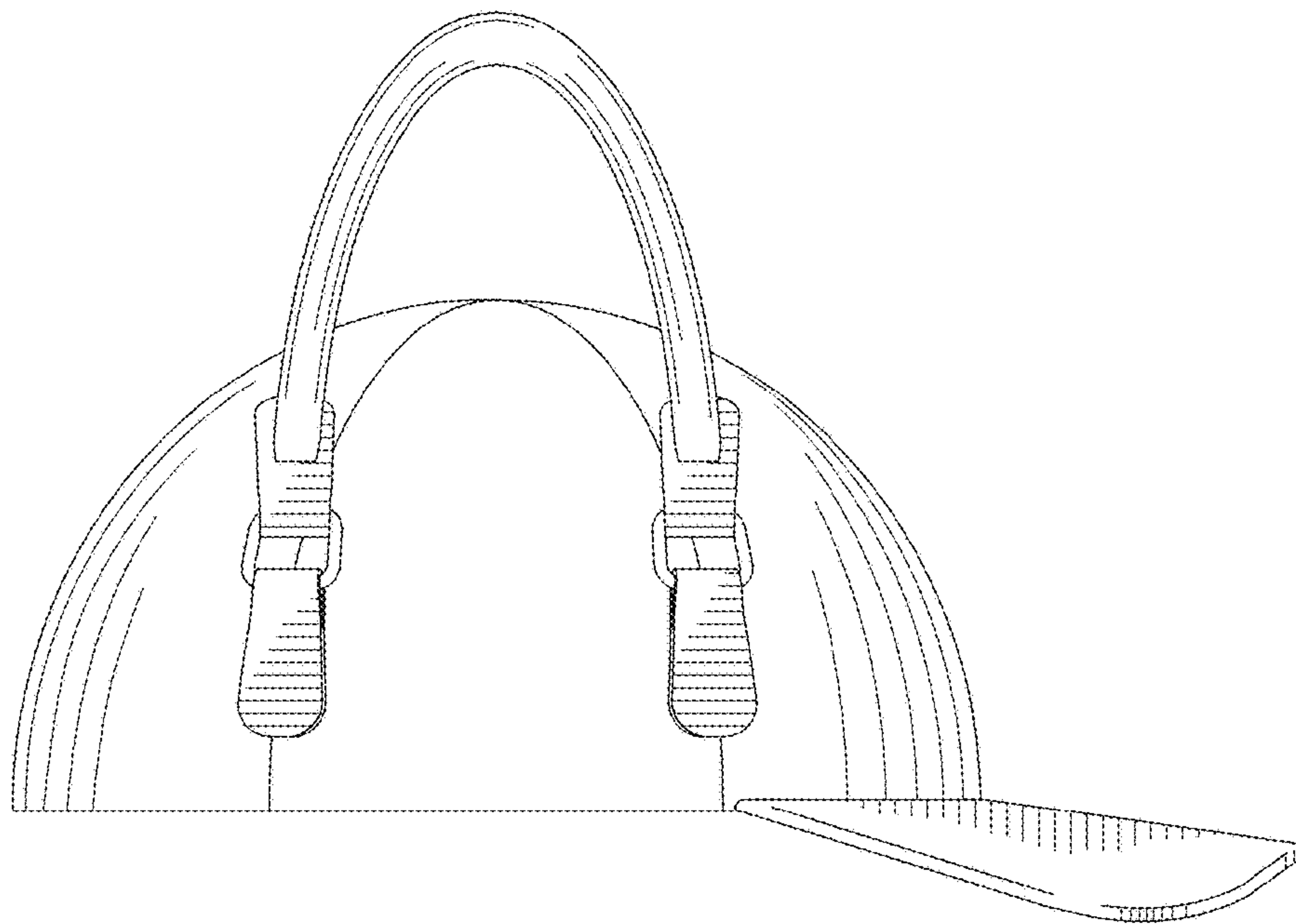

FIG.2

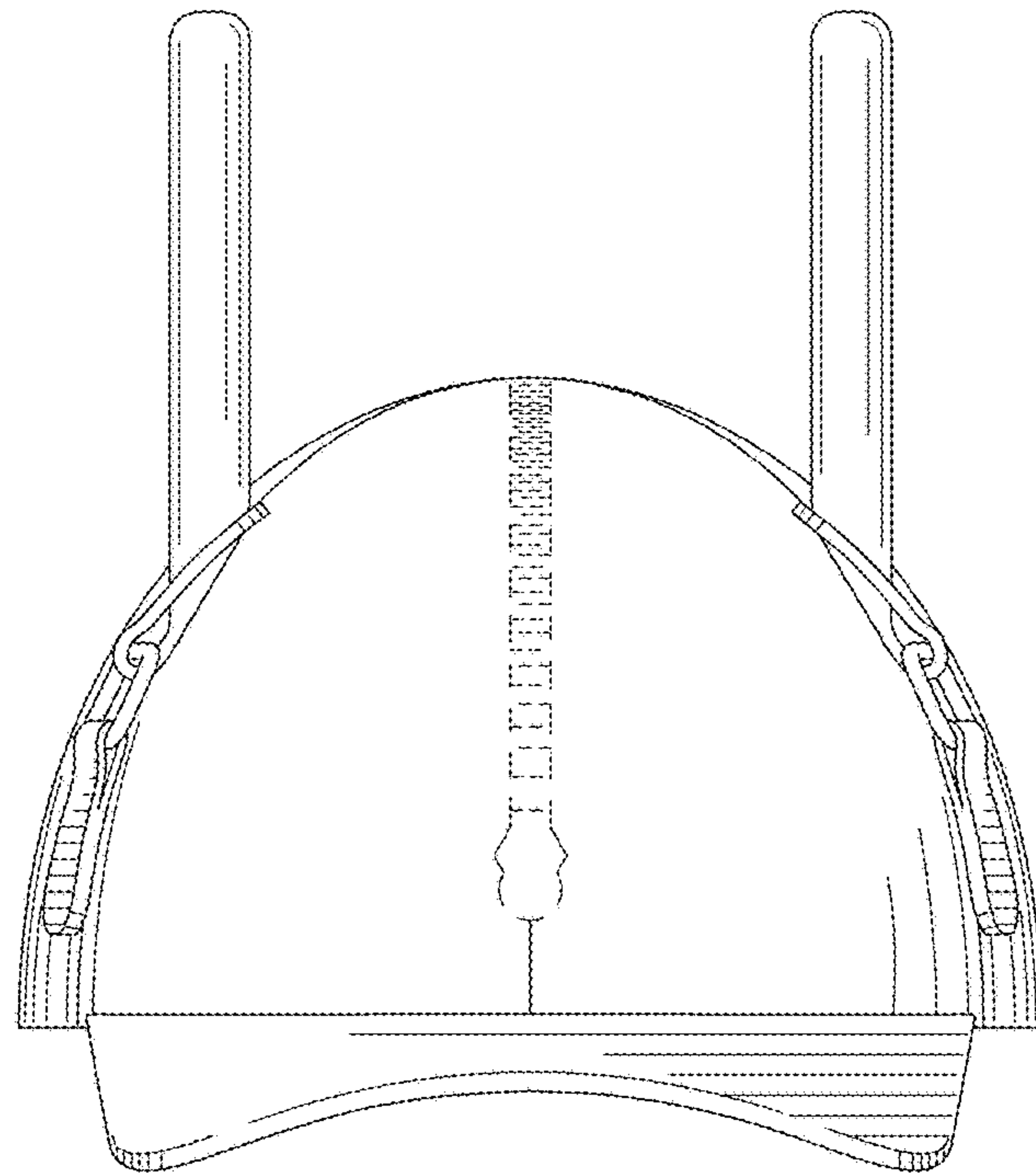

FIG. 3

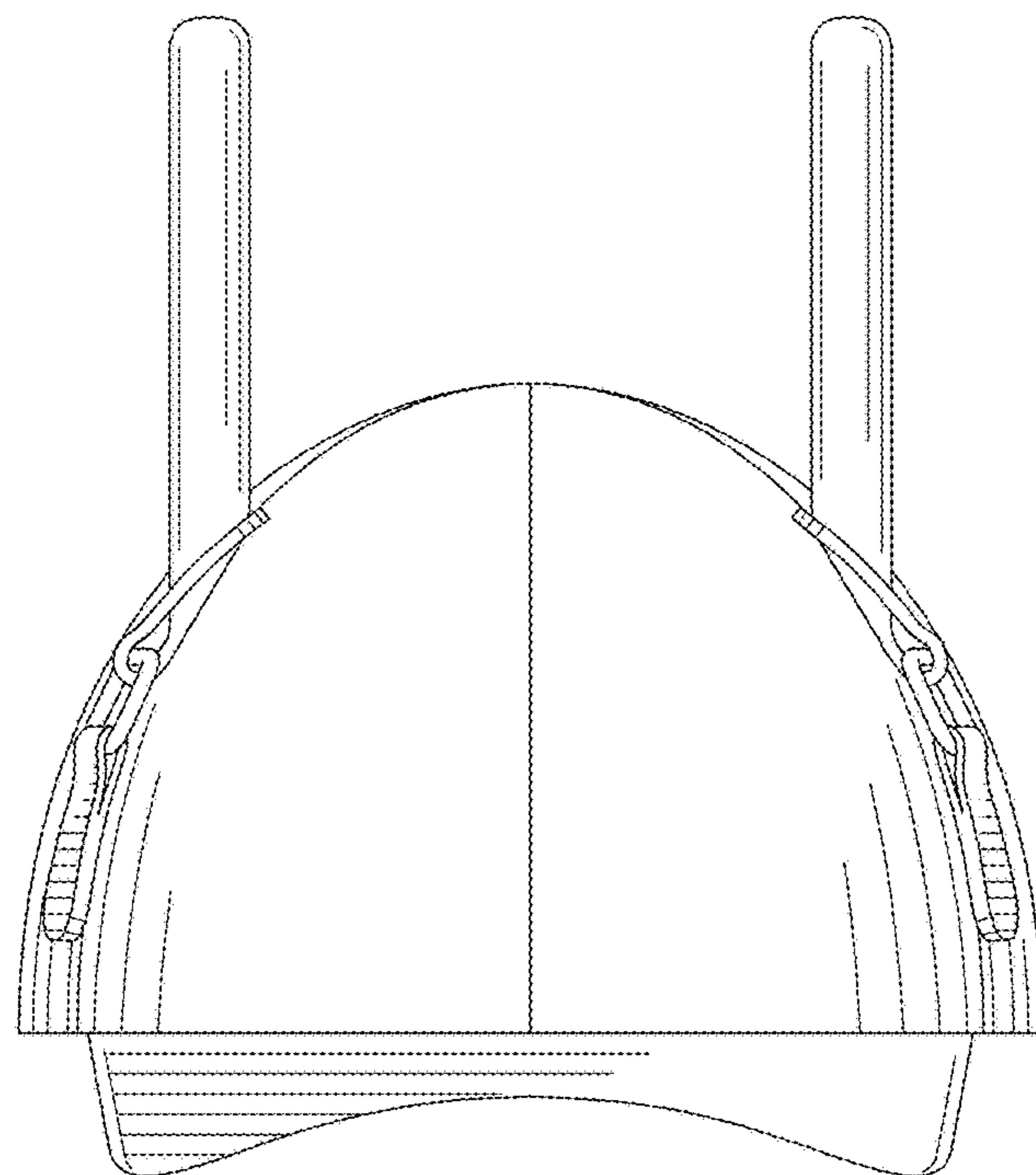

FIG. 4

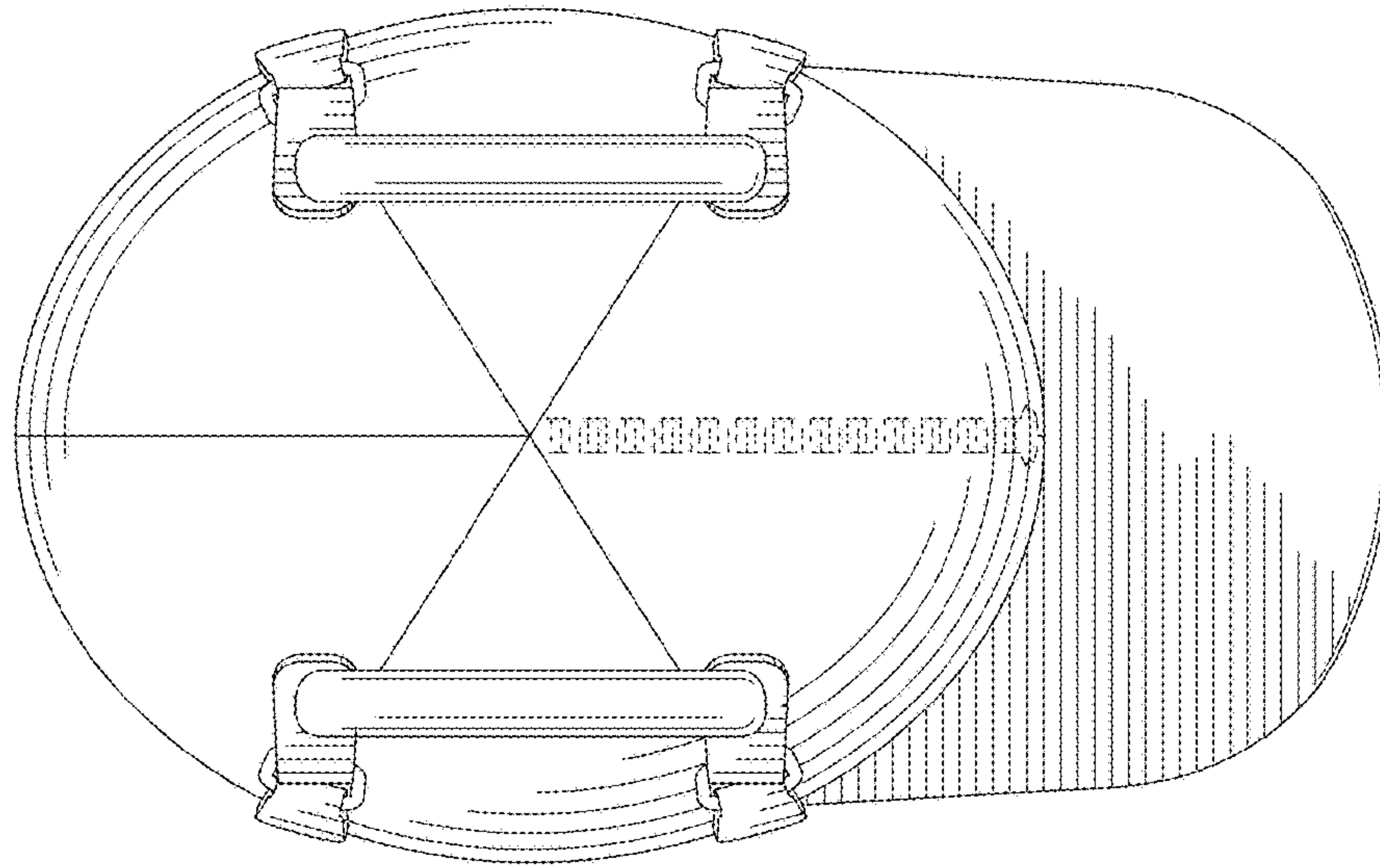

FIG. 5

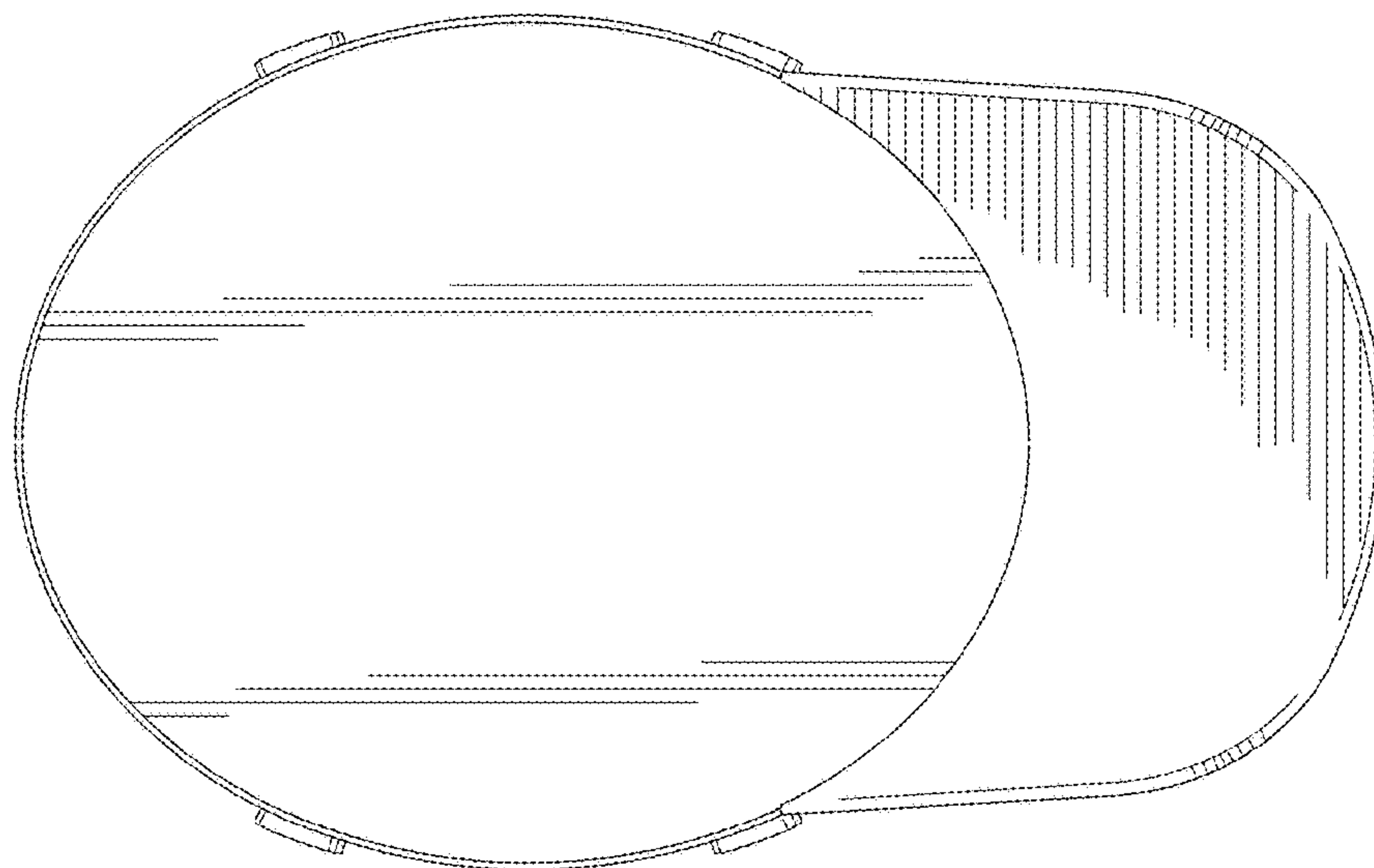

FIG. 6