



US00D801638S

(12) **United States Design Patent** (10) **Patent No.:** **US D801,638 S**  
**Curran** (45) **Date of Patent:** **\*\* \*Nov. 7, 2017**

(54) **CONVERTIBLE SHORTS**

FOREIGN PATENT DOCUMENTS

(71) Applicant: **11 Pine, Inc.**, Boulder, CO (US)

WO WO 2013/141479 9/2013

(72) Inventor: **David Jeffrey Curran**, Boulder, CO (US)

OTHER PUBLICATIONS

(73) Assignee: **11 Pine, Inc.**, Boulder, CO (US)

U.S. Appl. No. 29/504,333, filed Oct. 3, 2014, Curran.  
(Continued)

(\* ) Notice: This patent is subject to a terminal disclaimer.

*Primary Examiner* — Holly Baynham  
*Assistant Examiner* — Rashida C Walshon

(\*\*) Term: **15 Years**

(74) *Attorney, Agent, or Firm* — Talus Law Group LLC

(21) Appl. No.: **29/546,206**

(57) **CLAIM**

(22) Filed: **Nov. 19, 2015**

The ornamental design for convertible shorts, as shown and described.

**Related U.S. Application Data**

**DESCRIPTION**

(63) Continuation-in-part of application No. 29/504,333, filed on Oct. 3, 2014, now Pat. No. Des. 746,544.

(51) **LOC (10) Cl.** ..... **02-02**

(52) **U.S. Cl.**  
USPC ..... **D2/738; D2/731**

(58) **Field of Classification Search**  
USPC ..... D2/711–717, 731–738, 742, 748, 857,  
D2/728, 860–864  
CPC .. A41D 1/08; A41D 1/06; A41B 11/00; A63B  
71/12; A63B 71/1216  
See application file for complete search history.

FIG. 1 is a perspective view of the convertible shorts showing the new design;  
FIG. 2 is a front elevation view thereof;  
FIG. 3 is a back elevation view thereof;  
FIG. 4 is a right elevation view thereof;  
FIG. 5 is a left elevation view thereof;  
FIG. 6 is a top plan view thereof;  
FIG. 7 is a bottom plan view thereof;  
FIG. 8 is a perspective view showing the convertible shorts of FIG. 1 in a second position of use showing a side zipper in a closed position;  
FIG. 9 is a front elevation view thereof;  
FIG. 10 is a back elevation view thereof;  
FIG. 11 is a left side view thereof, the right side view being a mirror image thereof;  
FIG. 12 is a top plan view thereof; and,  
FIG. 13 is a bottom plan view thereof.  
The dashed lines refer to seams in FIGS. 1-13 and form no part of the claimed design. The lowermost broken line depicts the boundary of the claimed design and forms no part of the claimed design.

(56) **References Cited**

U.S. PATENT DOCUMENTS

3,110,903 A	11/1963	Burchard
3,945,051 A	3/1976	Burkard
D266,540 S	10/1982	Nacinovich
4,805,243 A	2/1989	Gibbens et al.
4,961,233 A	10/1990	Black
D313,692 S	1/1991	Karn
5,201,074 A	4/1993	Dicker
5,271,101 A	12/1993	Speth et al.
D360,516 S	7/1995	Persinger

(Continued)

**1 Claim, 11 Drawing Sheets**

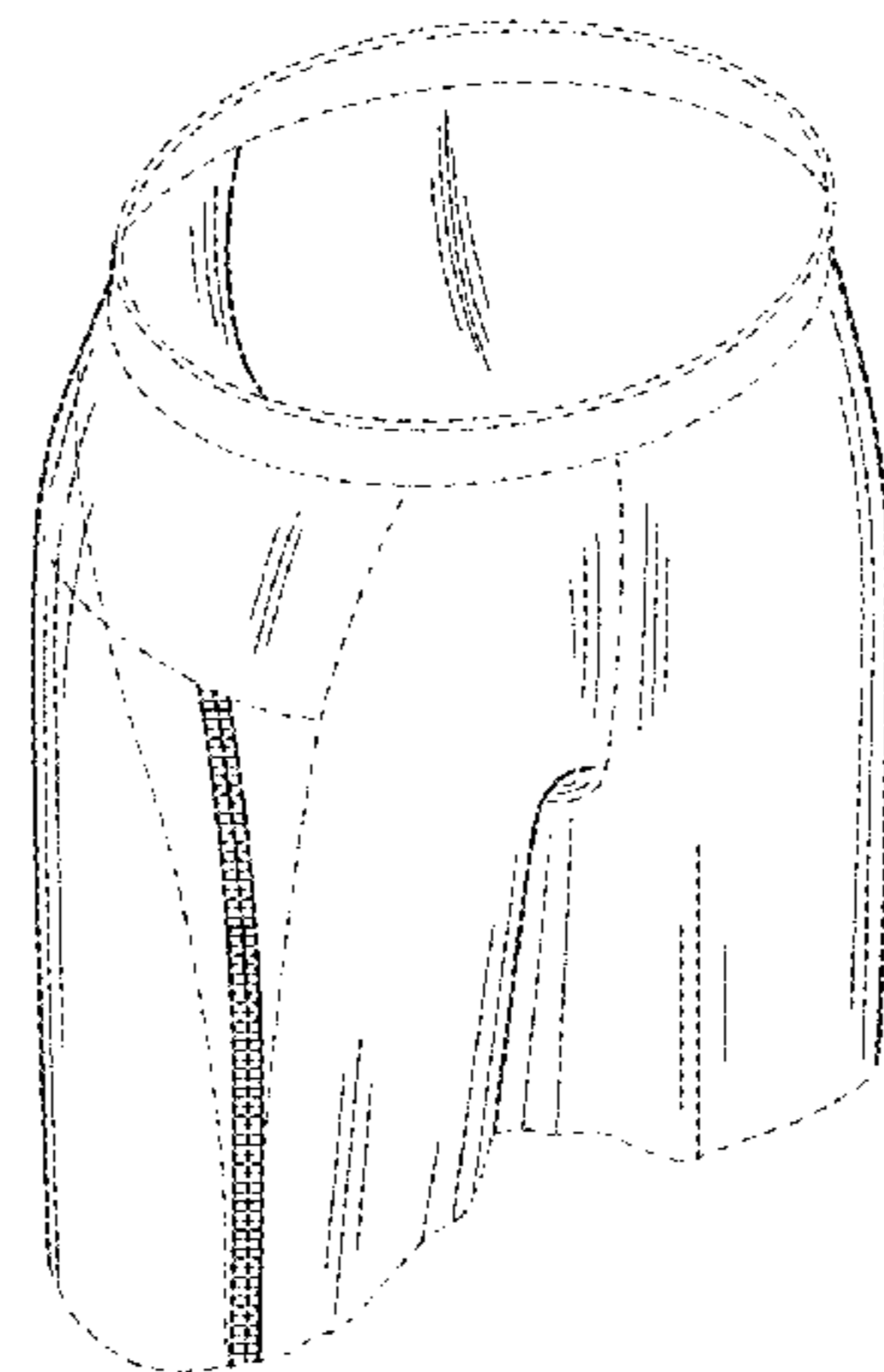
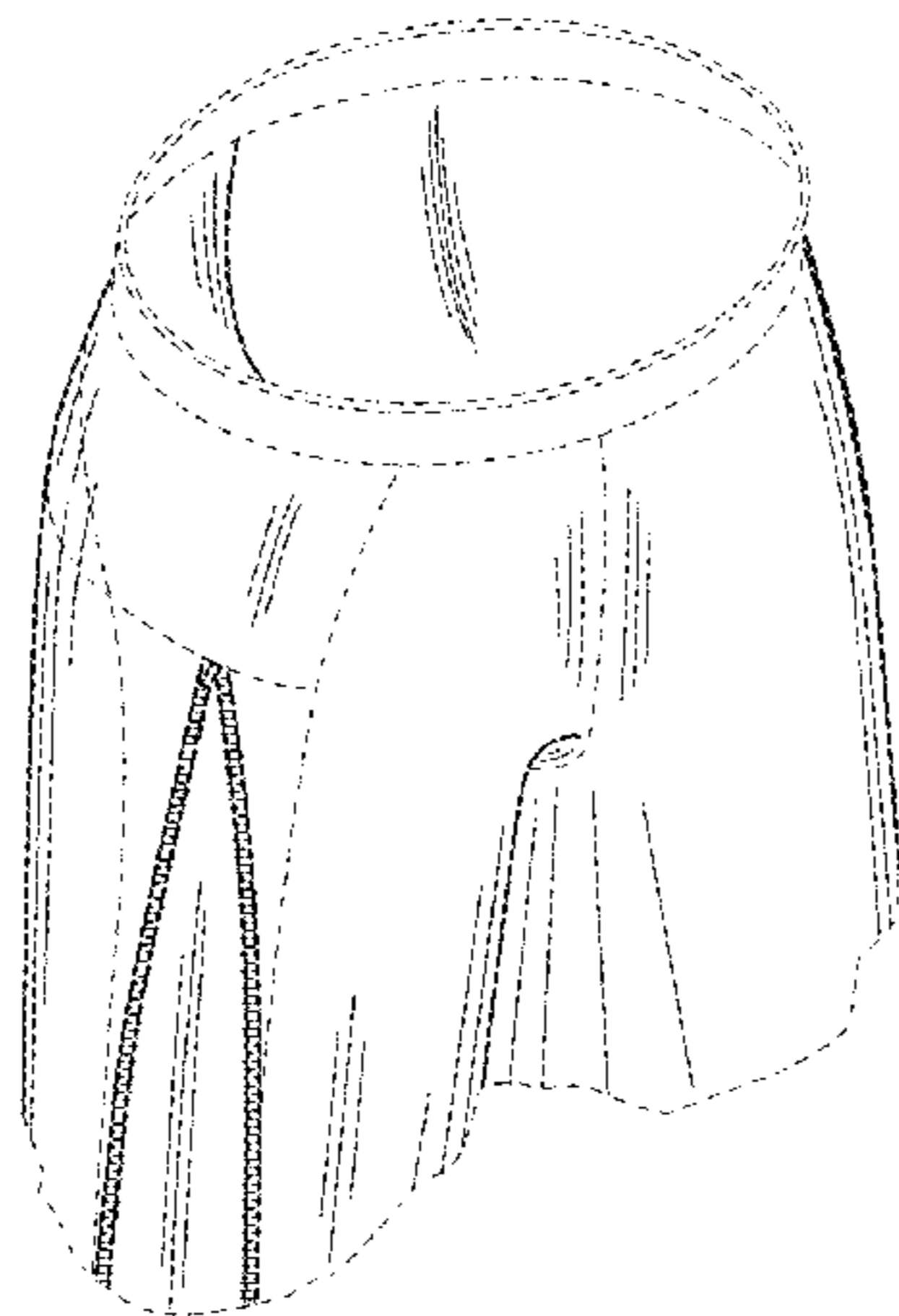

(56)

**References Cited**

U.S. PATENT DOCUMENTS

5,598,586	A	2/1997	Munjone	
5,636,380	A *	6/1997	Schindler .....	A41B 11/00 2/69
5,689,836	A *	11/1997	Fee .....	A41D 13/015 2/22
D403,487	S	1/1999	Crupi et al.	
D404,185	S *	1/1999	Lanter .....	D2/712
5,918,310	A	7/1999	Farahany	
D427,750	S *	7/2000	Fujii .....	D2/731
6,161,222	A	12/2000	Strickland et al.	
6,363,538	B1 *	4/2002	Davis .....	A41D 27/202 2/238
6,374,414	B1	4/2002	Collier	
6,684,410	B2	2/2004	Robinett et al.	
D487,609	S	3/2004	Cruz	
6,789,270	B1	9/2004	Pedrick	
6,918,140	B1	7/2005	Cooper	
D515,282	S *	2/2006	Africa .....	D2/714
D518,277	S *	4/2006	Collier .....	D2/738
D525,765	S *	8/2006	Arensdorf .....	D2/712
D546,029	S *	7/2007	Rindle .....	D2/738
D591,928	S	5/2009	Kirsch et al.	

D597,281	S	8/2009	Young
7,631,366	B2	12/2009	Oyama et al.
7,832,022	B1	11/2010	Peters
7,941,871	B1	5/2011	Jorgensen
D661,464	S	6/2012	Wilson
D663,102	S	7/2012	Hogg
D674,166	S	1/2013	Wilson
D701,676	S	4/2014	Savage
D711,626	S	8/2014	Savage
D714,523	S	10/2014	Stinson et al.
2006/0185065	A1	8/2006	Allen

OTHER PUBLICATIONS

U.S. Appl. No. 14/873,367, filed Oct. 2, 2015, Curran.  
 Official Action for Canadian Patent Application No. 161811, dated Jul. 24, 2015, 1 page.  
 Notice of Allowance for U.S. Appl. No. 29/504,333, mailed Sep. 15, 2015, 7 pages.  
 International Search Report and Written Opinion for International (PCT) Patent Application No. PCT/US2015/053652, mailed Feb. 2, 2016 12 pages.

\* cited by examiner

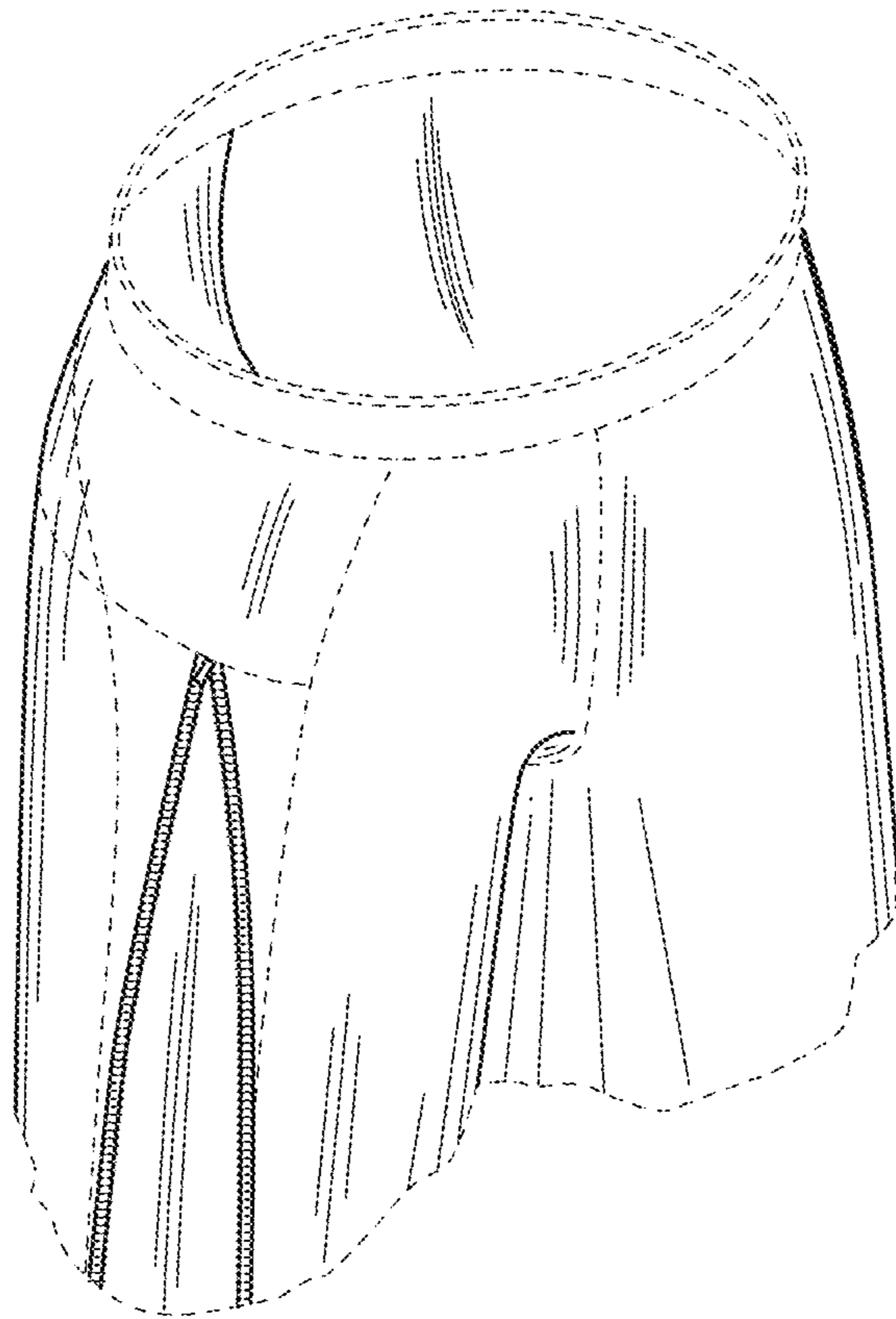

FIG.1

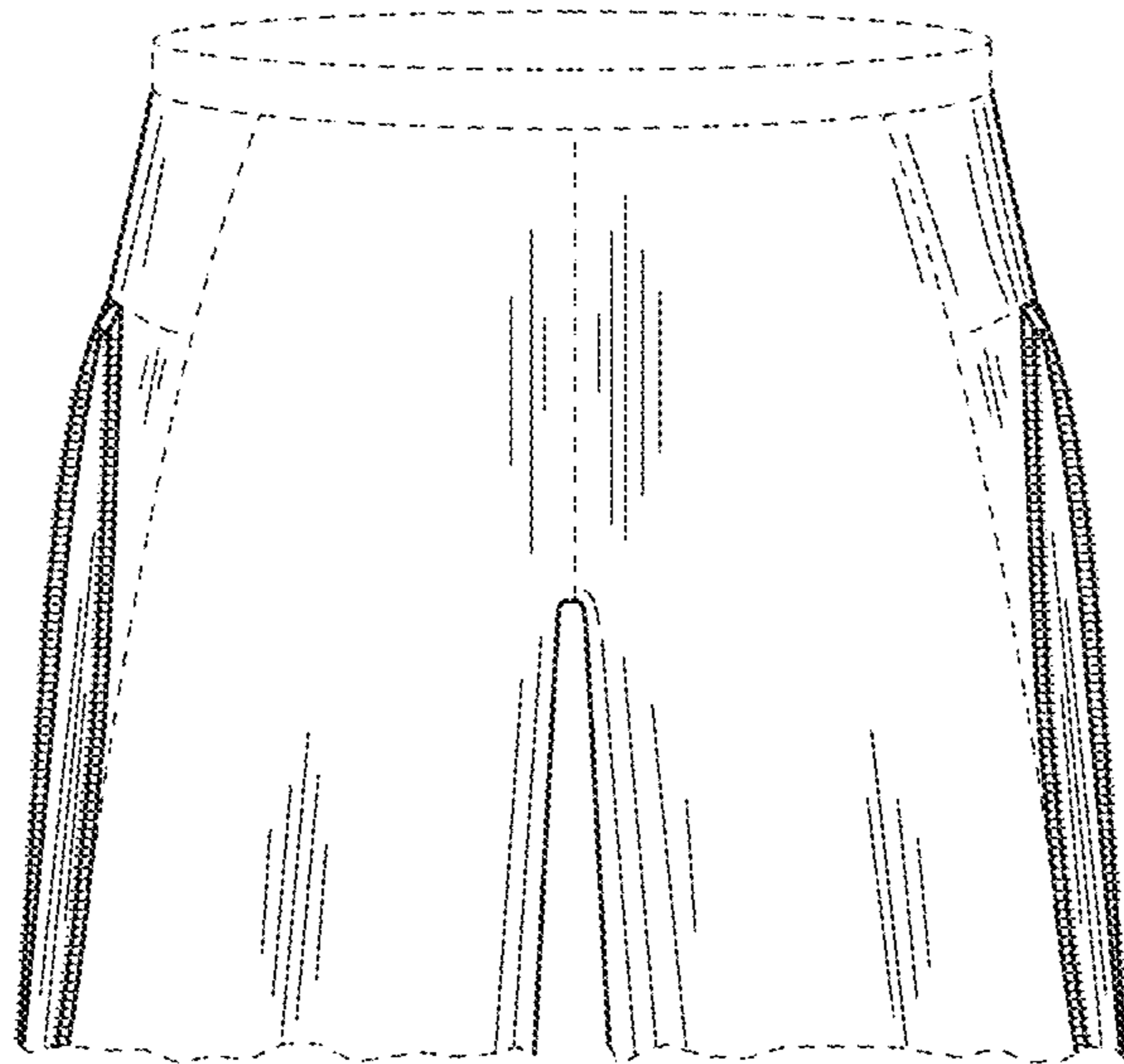

FIG.2

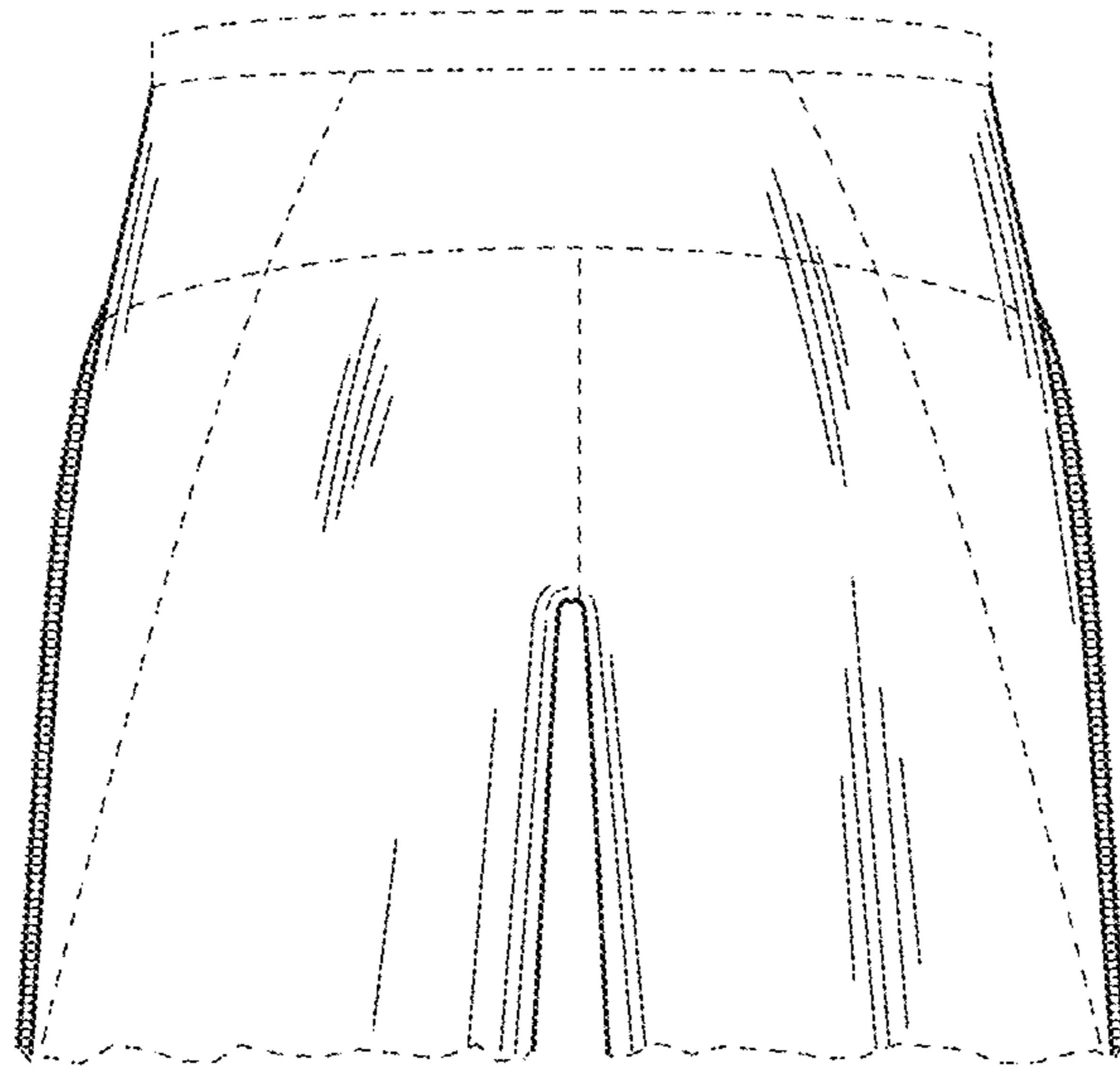

FIG.3

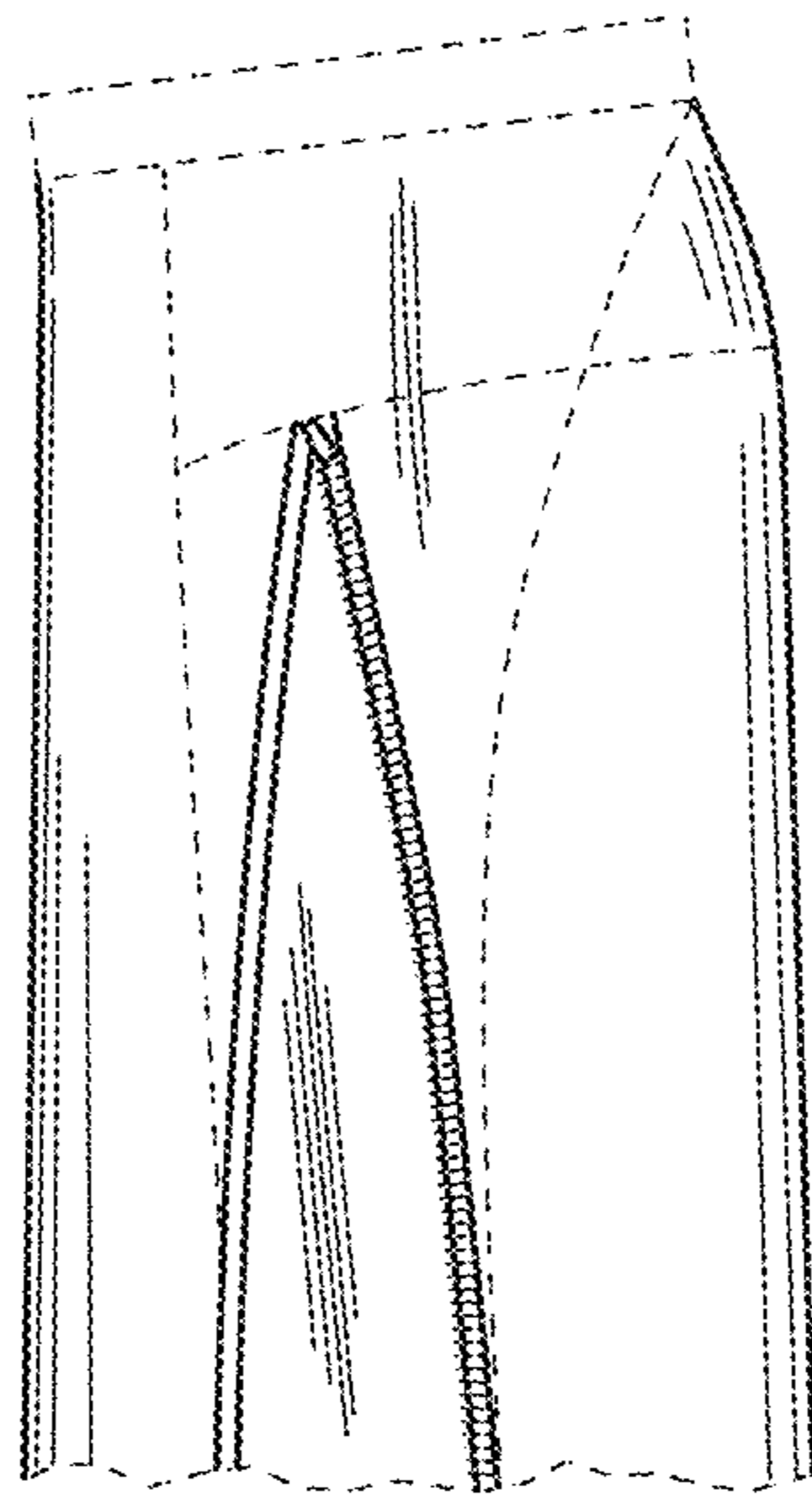

FIG.4

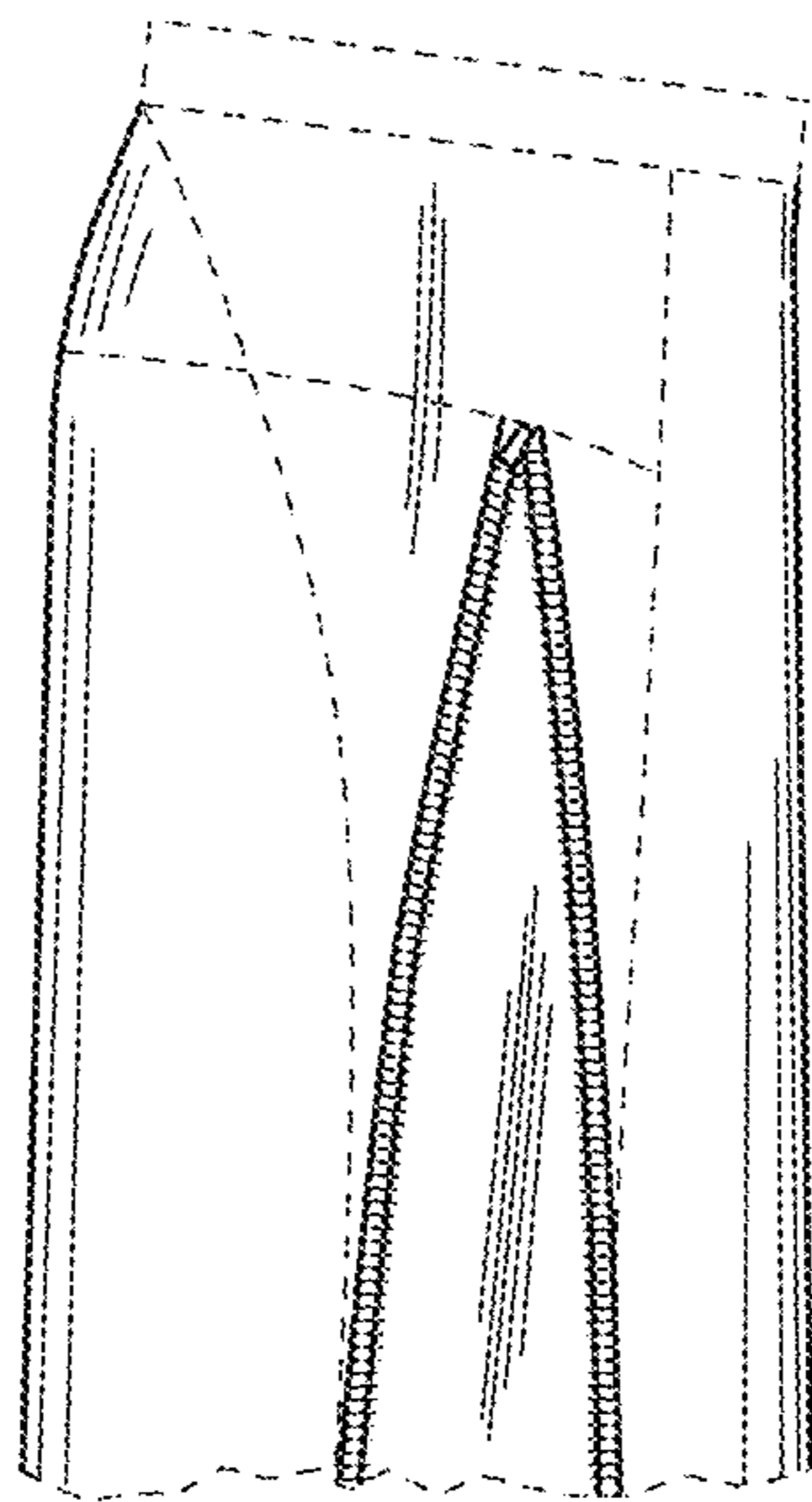

FIG.5

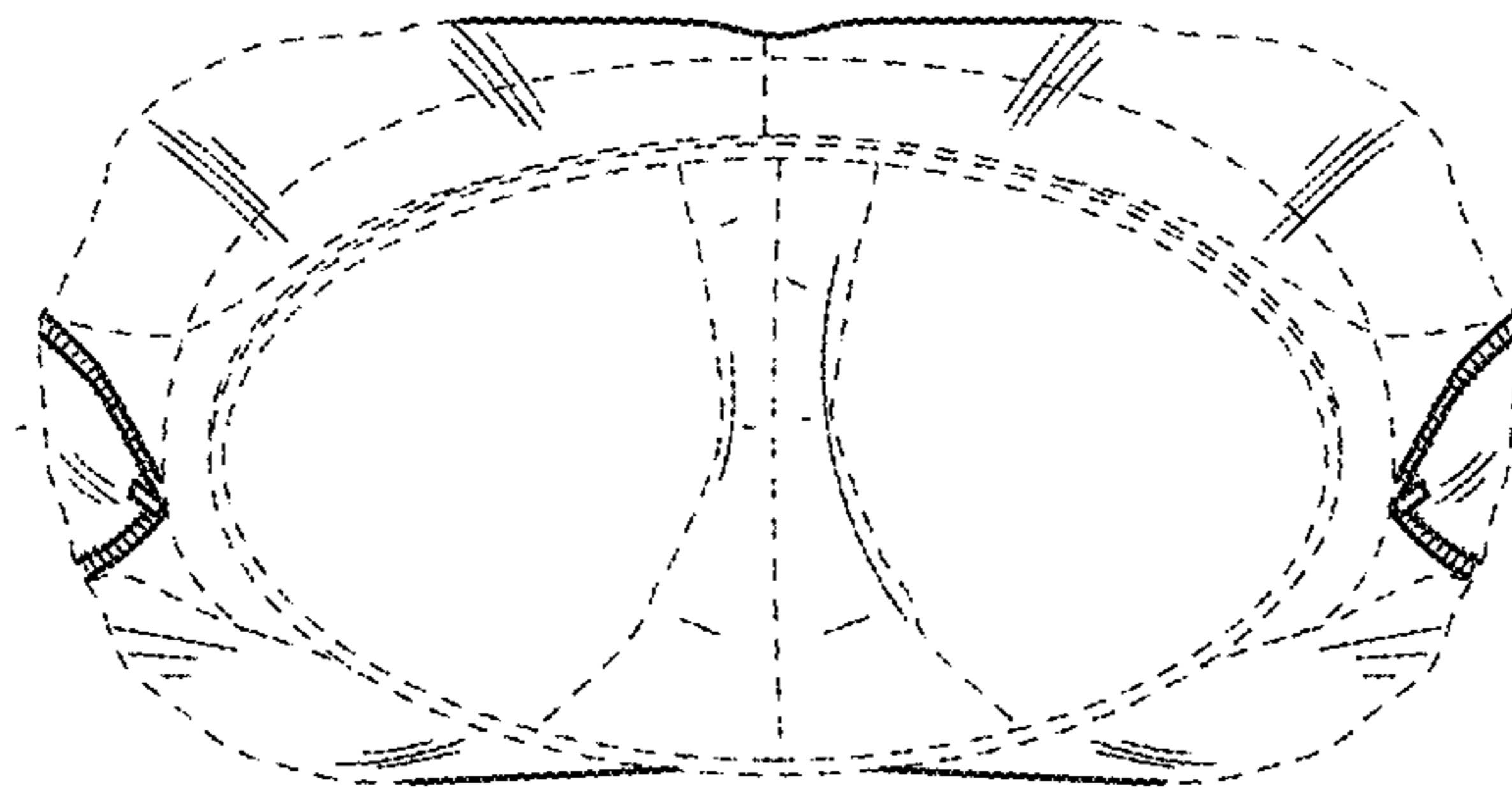

FIG. 6

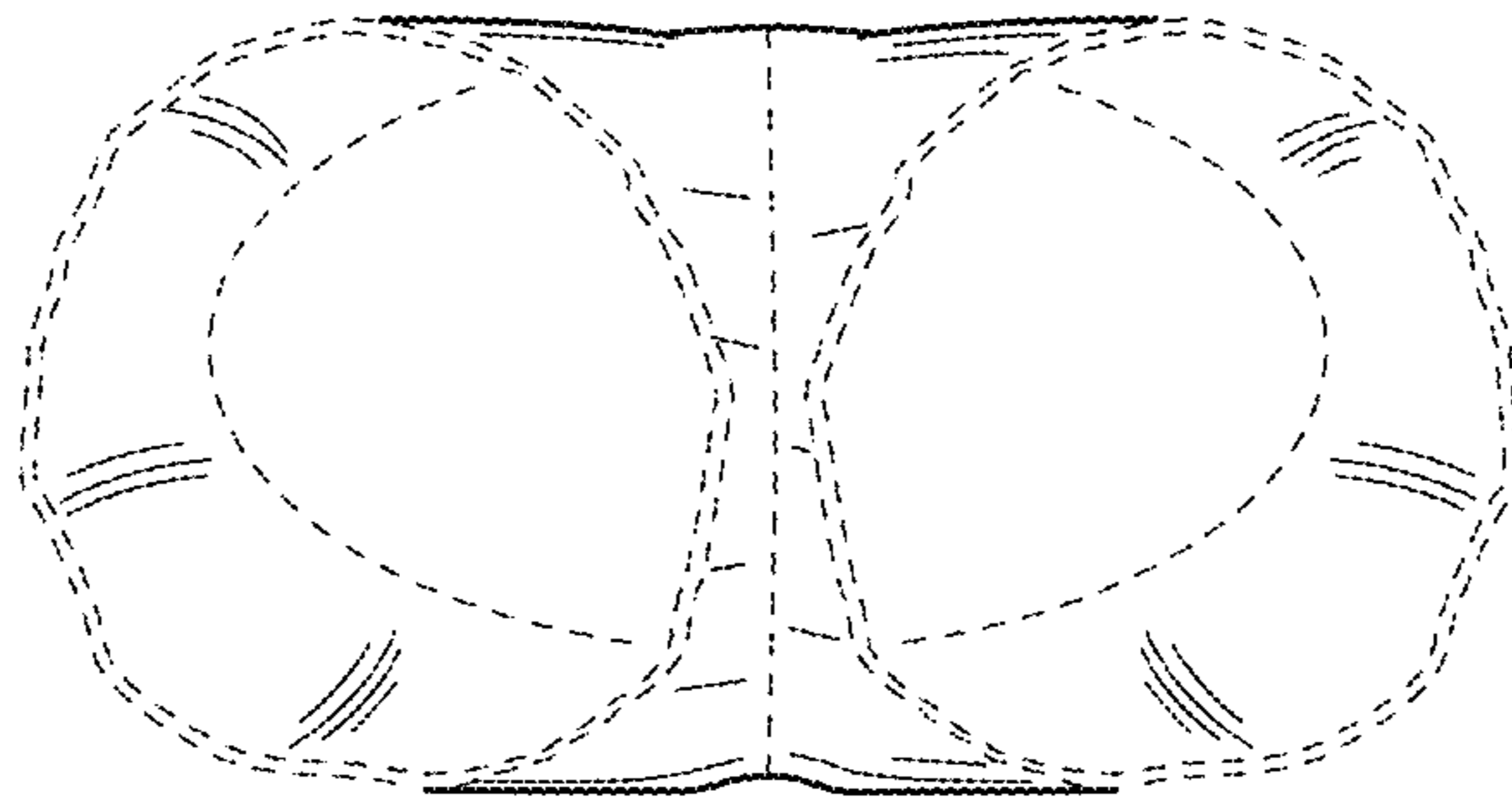

FIG. 7



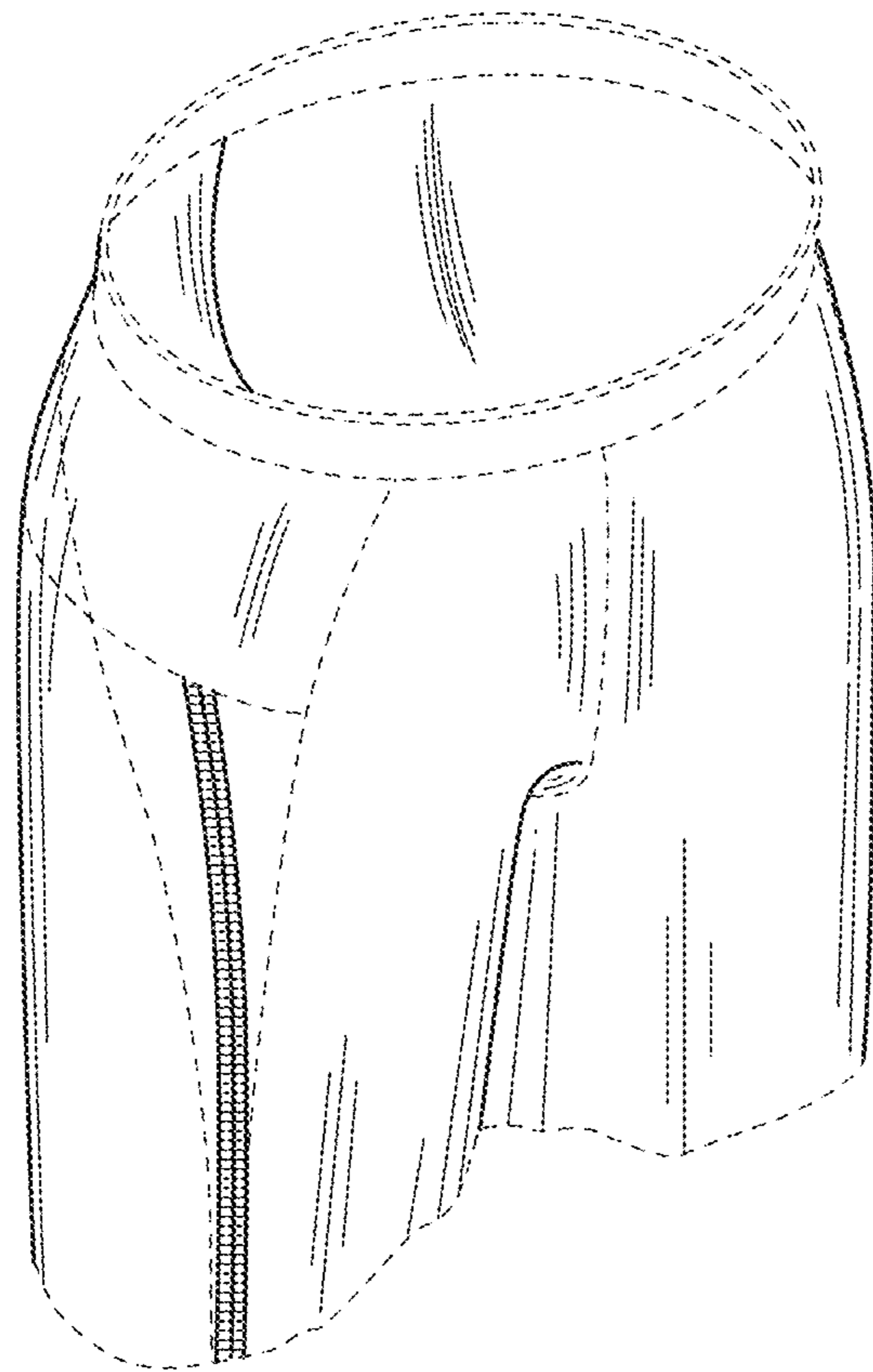

FIG.8

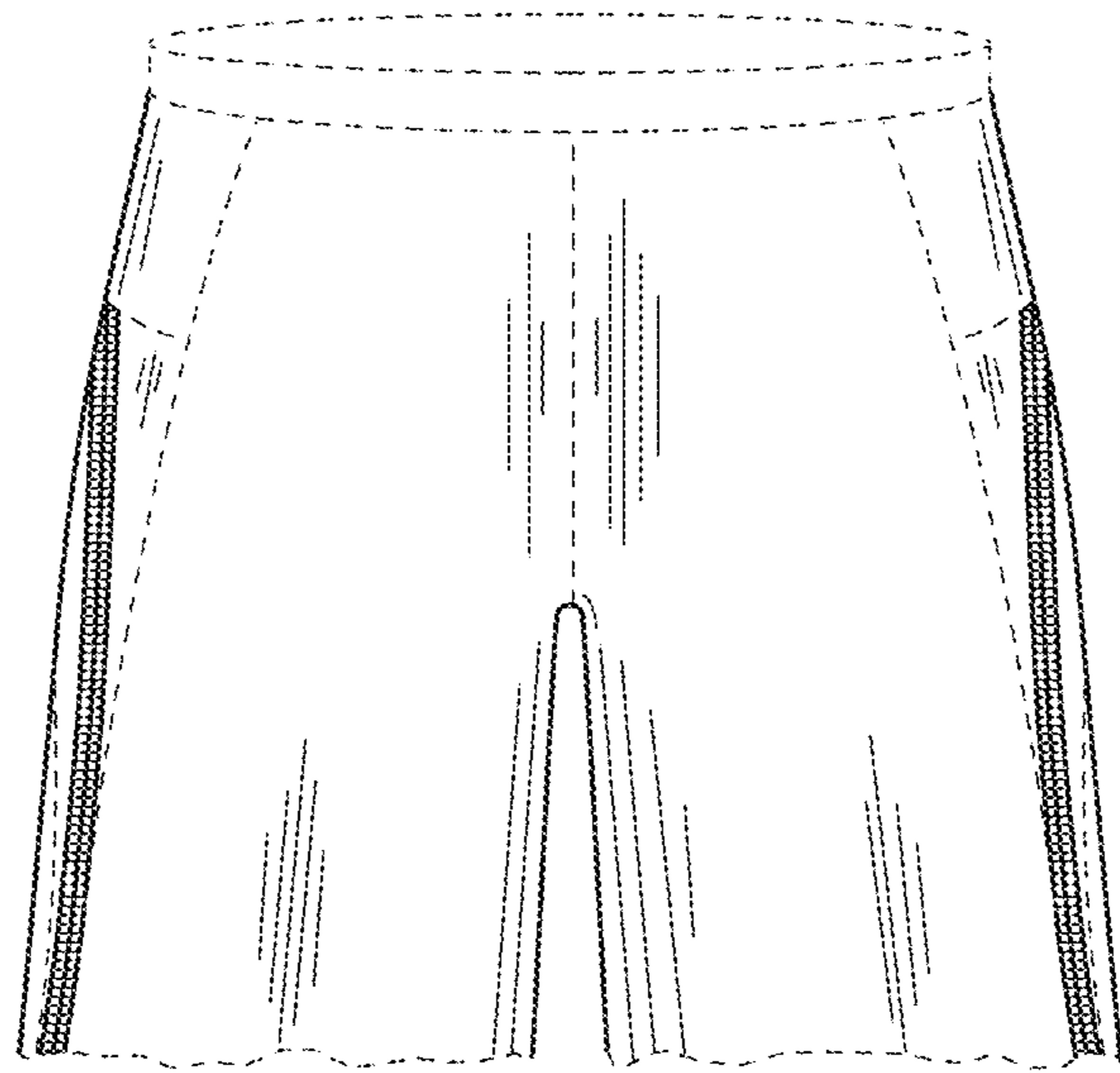

FIG.9

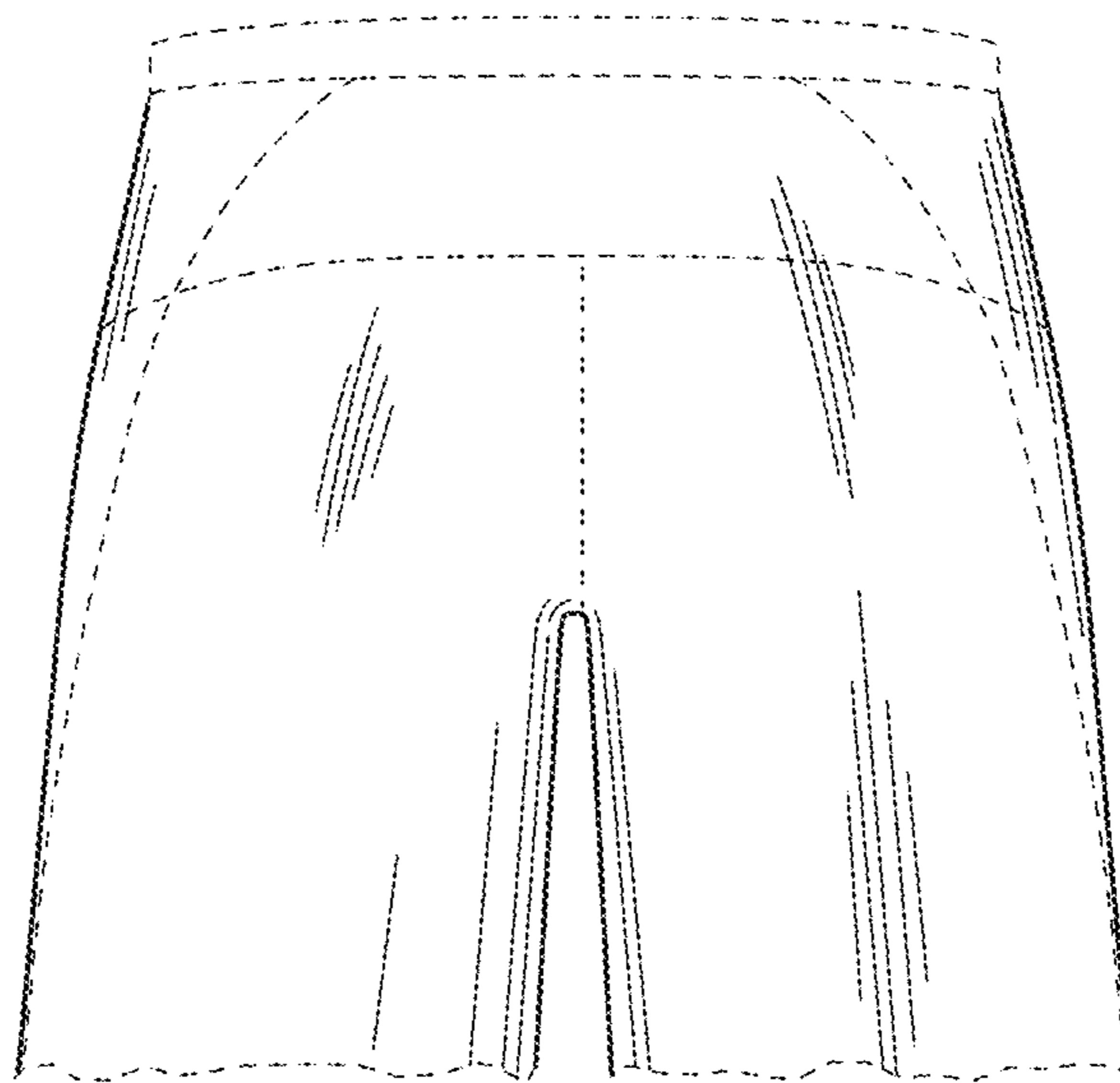

FIG.10

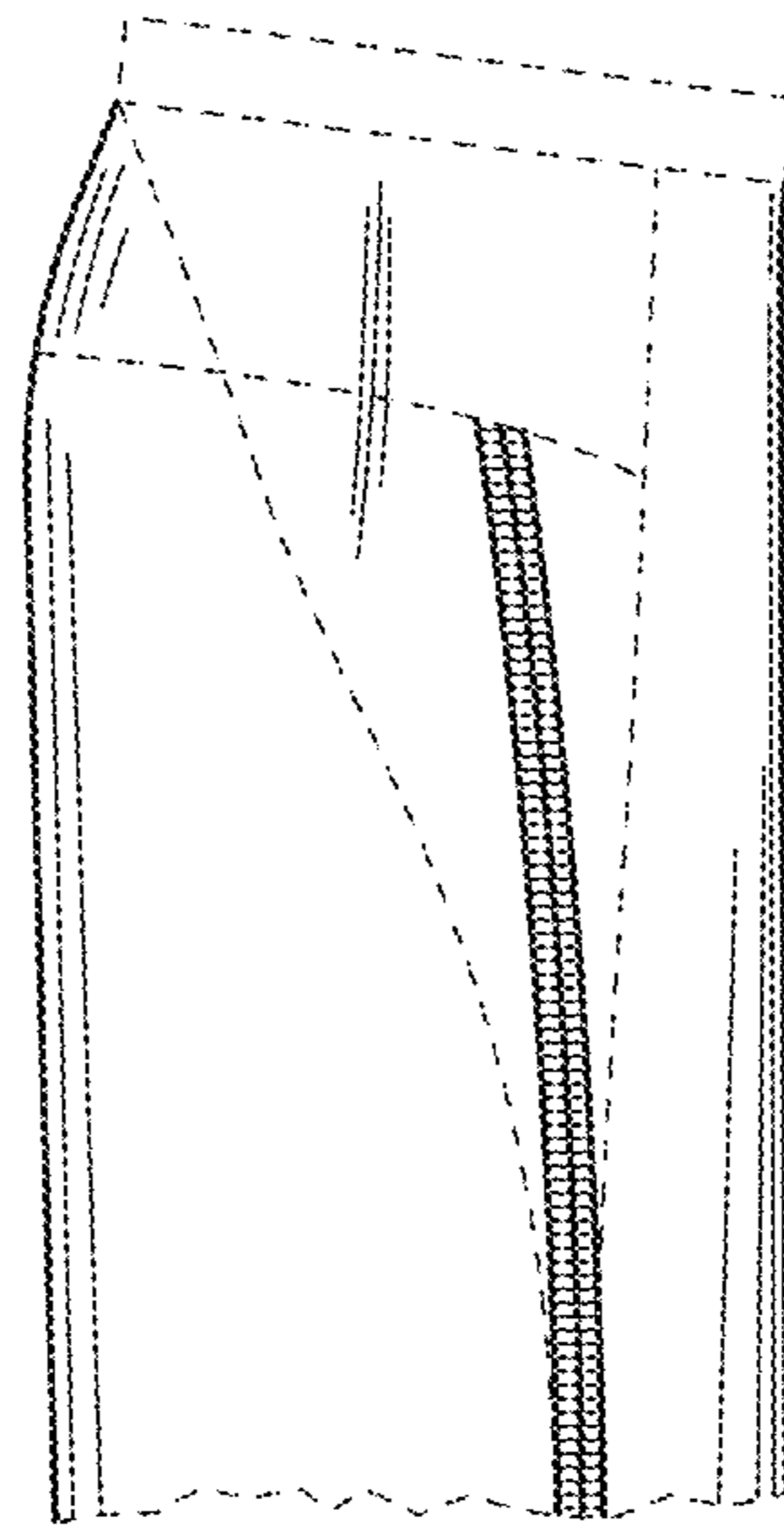

FIG.11

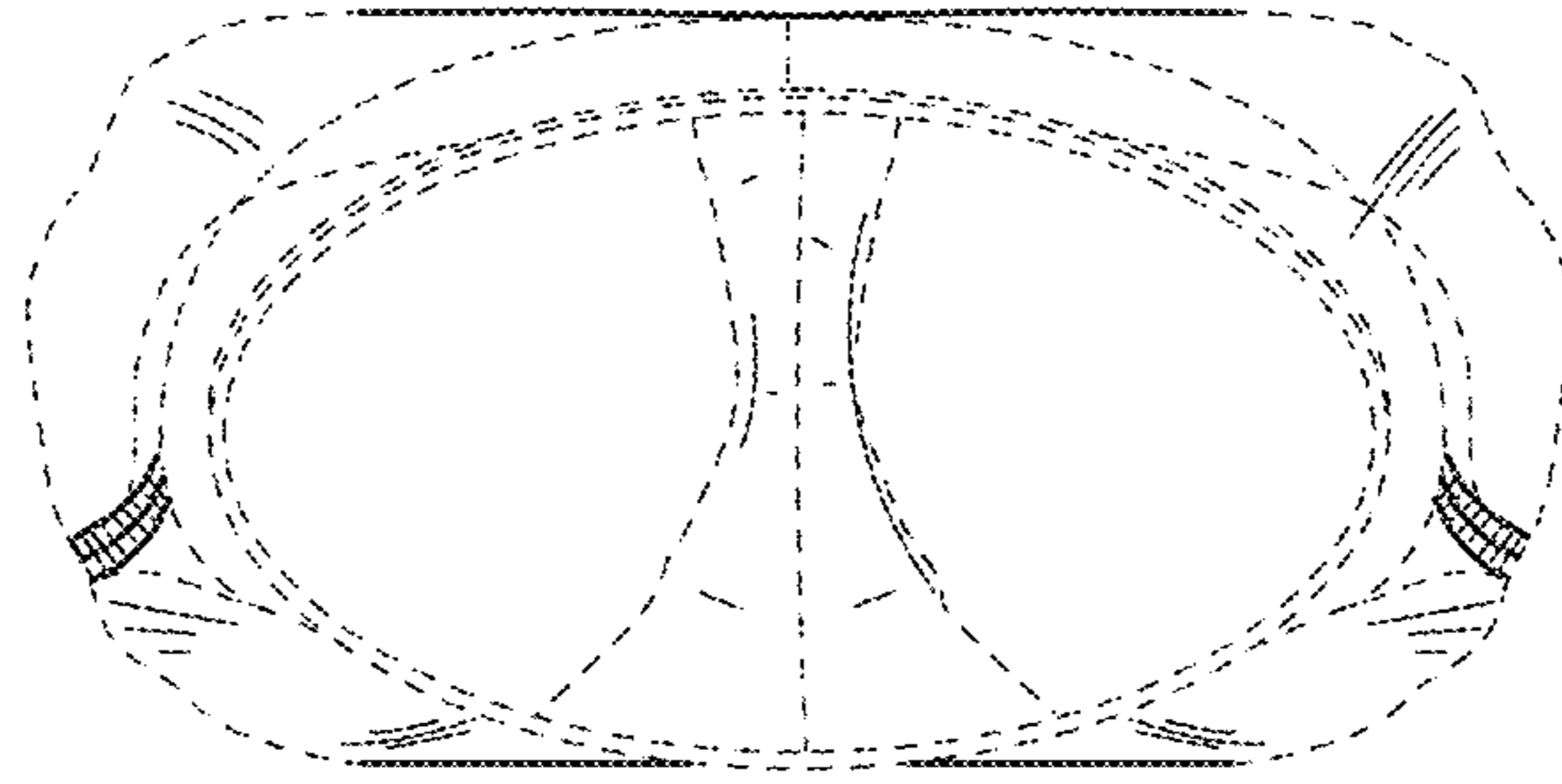

FIG. 12

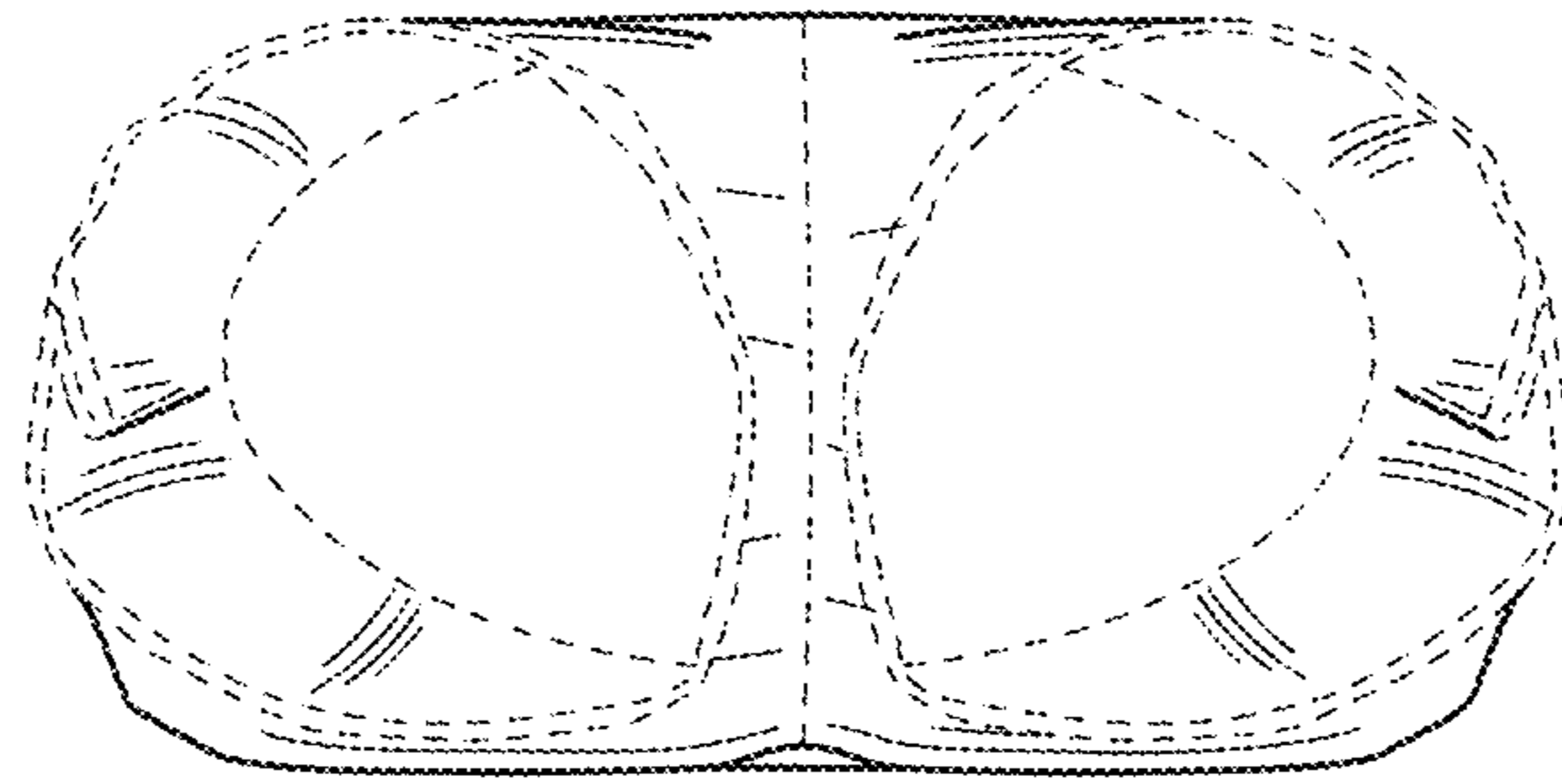

FIG. 13