



US00D801596S

(12) **United States Design Patent**  
**Tota**

(10) **Patent No.:** **US D801,596 S**  
(45) **Date of Patent:** **\*\* Oct. 31, 2017**

- (54) **BRIDLE NOSEBAND**
- (71) Applicant: **Charles Tota**, Wellington, FL (US)
- (72) Inventor: **Charles Tota**, Wellington, FL (US)
- (\*\*) Term: **15 Years**
- (21) Appl. No.: **29/569,504**
- (22) Filed: **Jun. 28, 2016**
- (51) **LOC (10) Cl.** ..... **30-01**
- (52) **U.S. Cl.**  
USPC ..... **D30/136**
- (58) **Field of Classification Search**  
USPC ..... D30/134, 136, 138  
CPC ..... B68B 1/02; B68B 1/04; B68B 2001/042;  
B68B 5/00; A01K 27/003; A01K 27/005;  
A01L 27/004; A63B 21/0557  
See application file for complete search history.

9,346,664 B2 \* 5/2016 Krickeberg ..... B68B 1/02  
 9,427,049 B2 \* 8/2016 Shelton ..... A44B 11/22  
 2004/0168413 A1 \* 9/2004 Rodgers ..... B68B 1/04  
 54/6.1

FOREIGN PATENT DOCUMENTS

DE 102013014464 3/2015

\* cited by examiner

*Primary Examiner* — George D Kirschbaum  
*Assistant Examiner* — Jennifer L Watkins  
 (74) *Attorney, Agent, or Firm* — Robert M. Downey, P.A.

(57) **CLAIM**

The ornamental design for a bridle noseband, as shown and described.

**DESCRIPTION**

FIG. 1 is a top perspective view of a bridle noseband showing my new design;  
 FIG. 2 is a left side elevational view thereof;  
 FIG. 3 is a right side elevational view thereof;  
 FIG. 4 is a top plan view thereof;  
 FIG. 5 is a bottom plan view thereof;  
 FIG. 6 is a rear elevational view thereof; and,  
 FIG. 7 is a front elevational view thereof.  
 The broken lines shown in FIGS. 1-7 showing buckles and attachment rings form no part of the claimed design.

(56) **References Cited**

U.S. PATENT DOCUMENTS

D251,860 S \* 5/1979 Meeks ..... D30/136  
 D467,046 S \* 12/2002 Paci ..... D30/136  
 D635,724 S 4/2011 Micklem  
 8,789,349 B1 \* 7/2014 Drumm ..... B68B 1/04  
 54/6.1  
 8,915,053 B2 12/2014 Verger

**1 Claim, 7 Drawing Sheets**

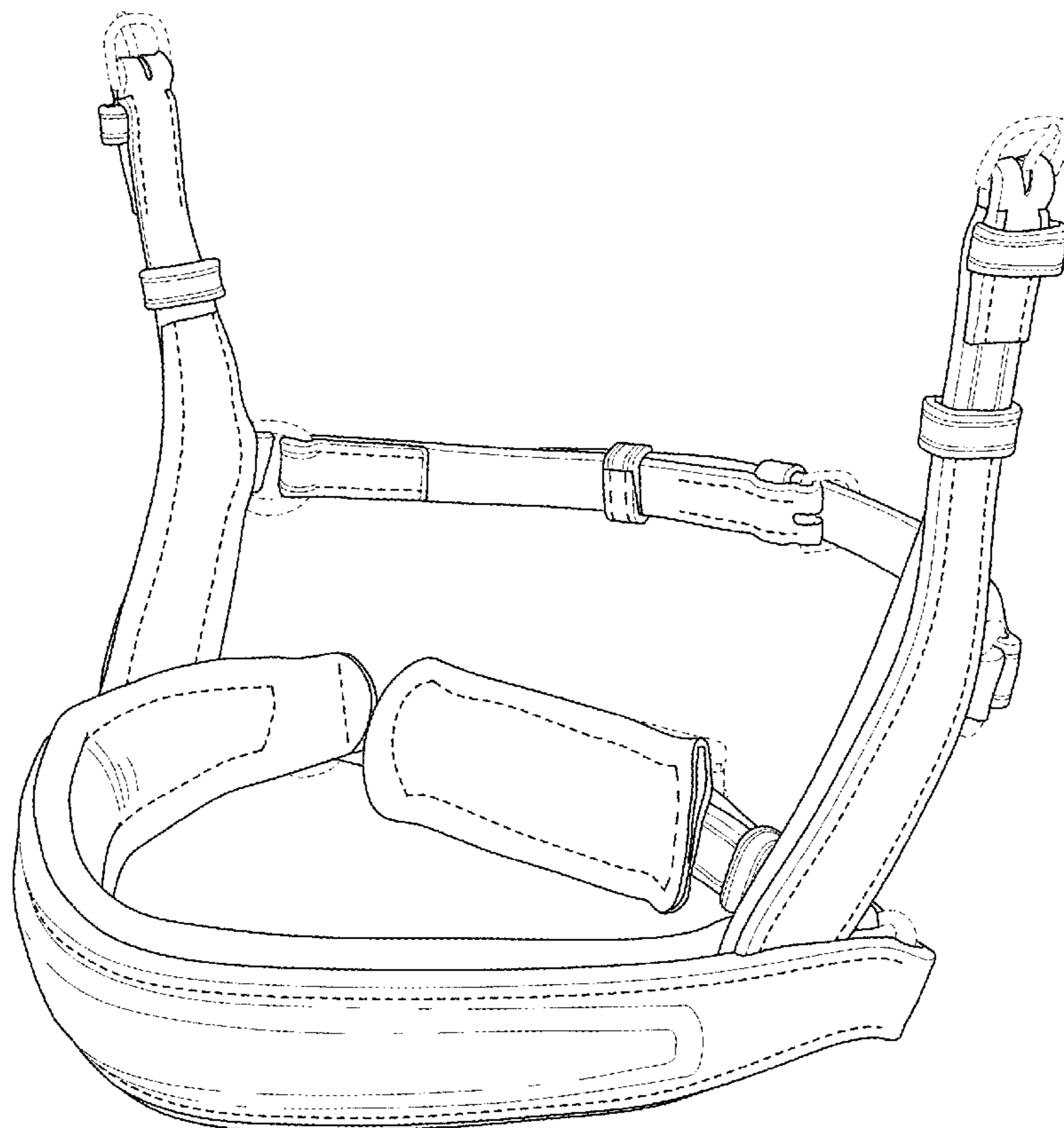

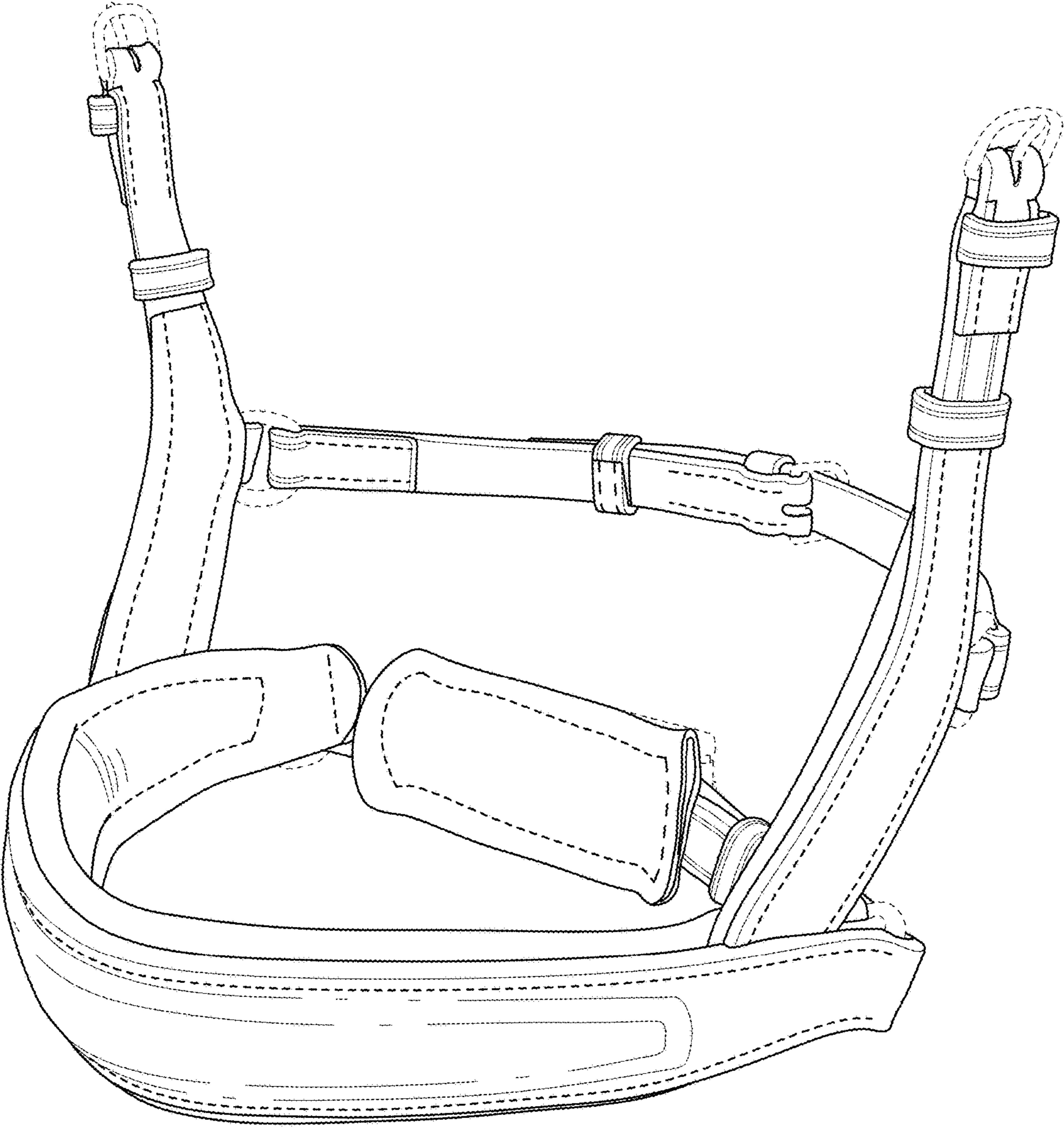

FIG. 1

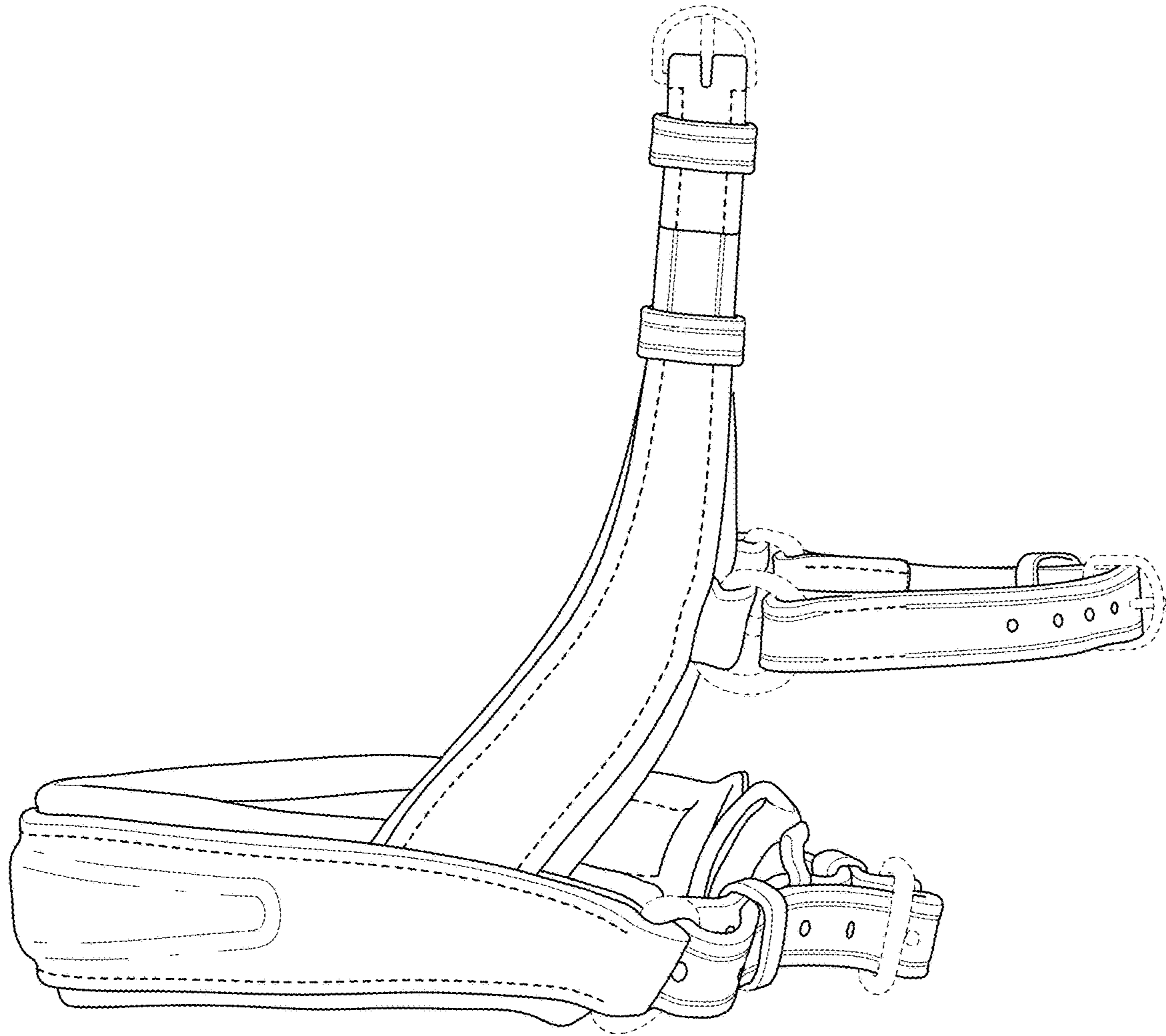

FIG. 2

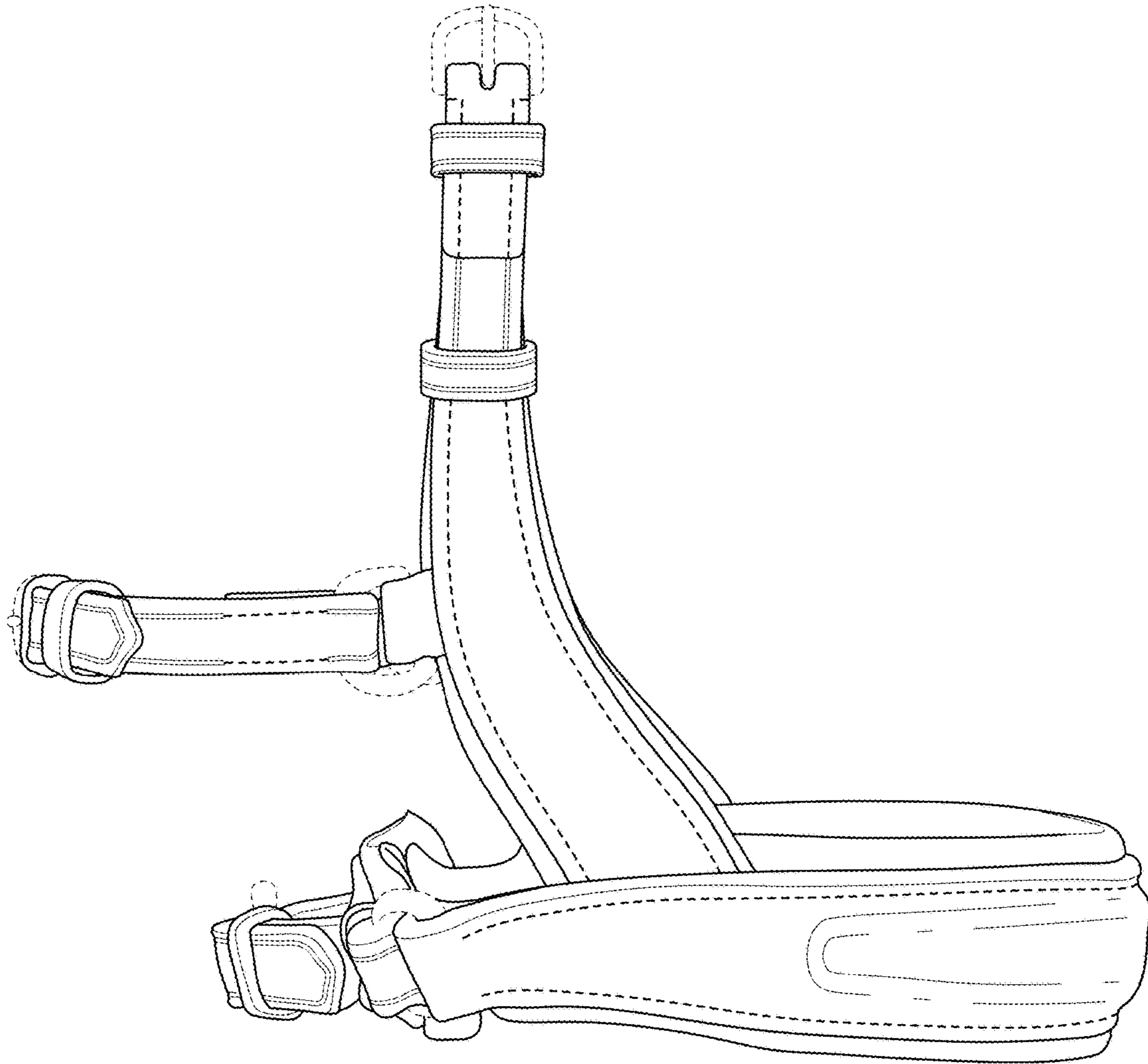

FIG. 3

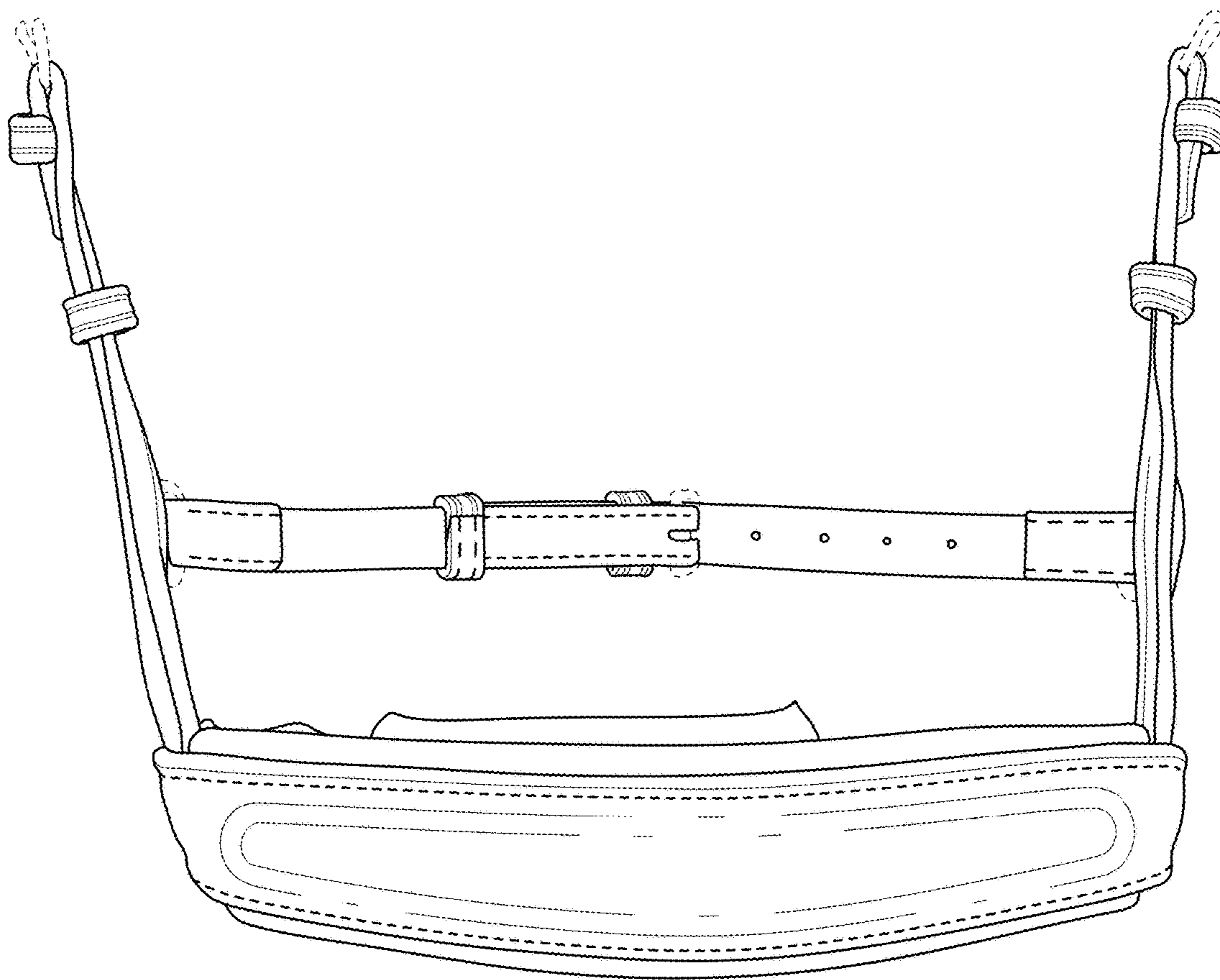

FIG. 4

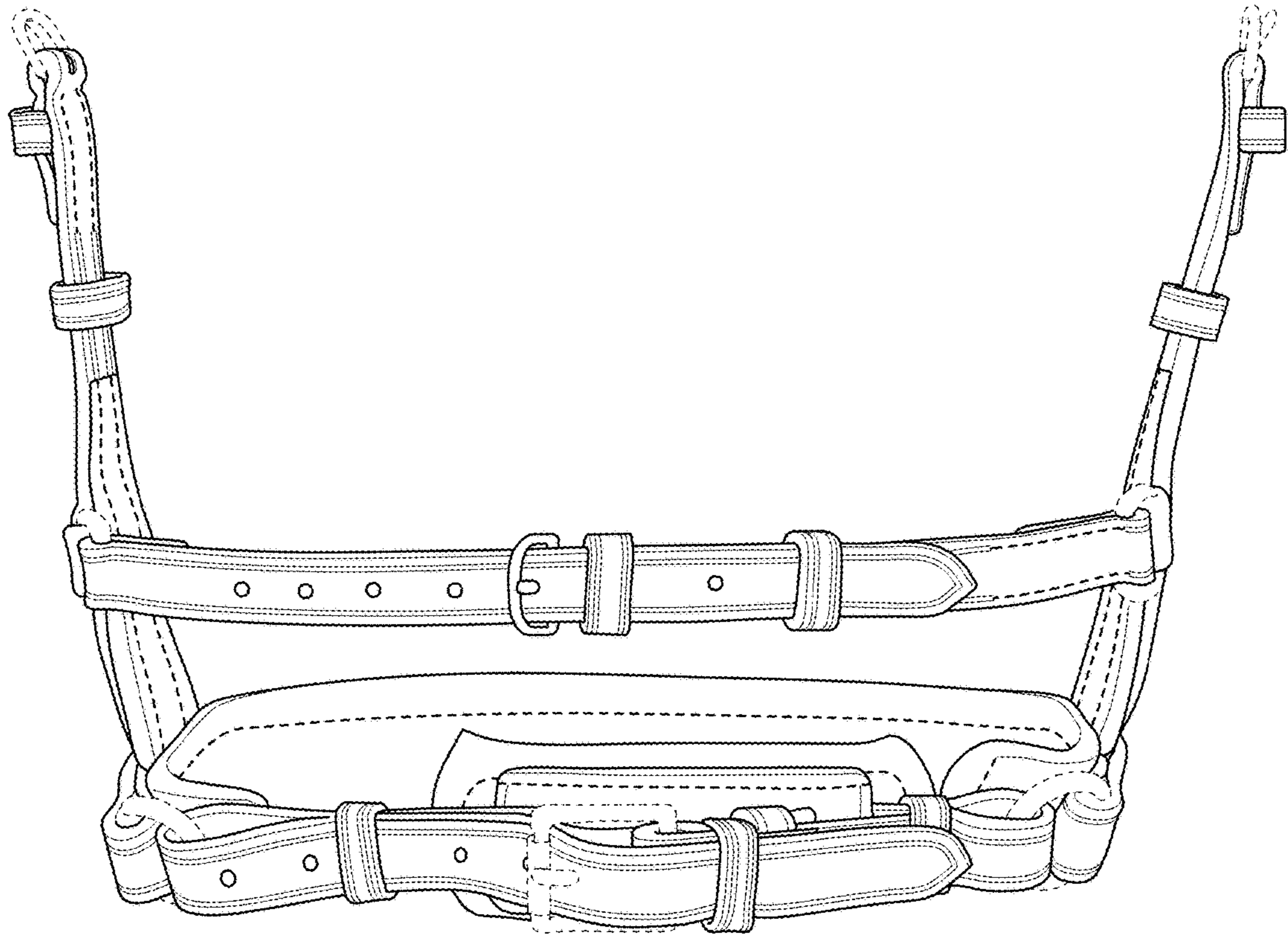

FIG. 5

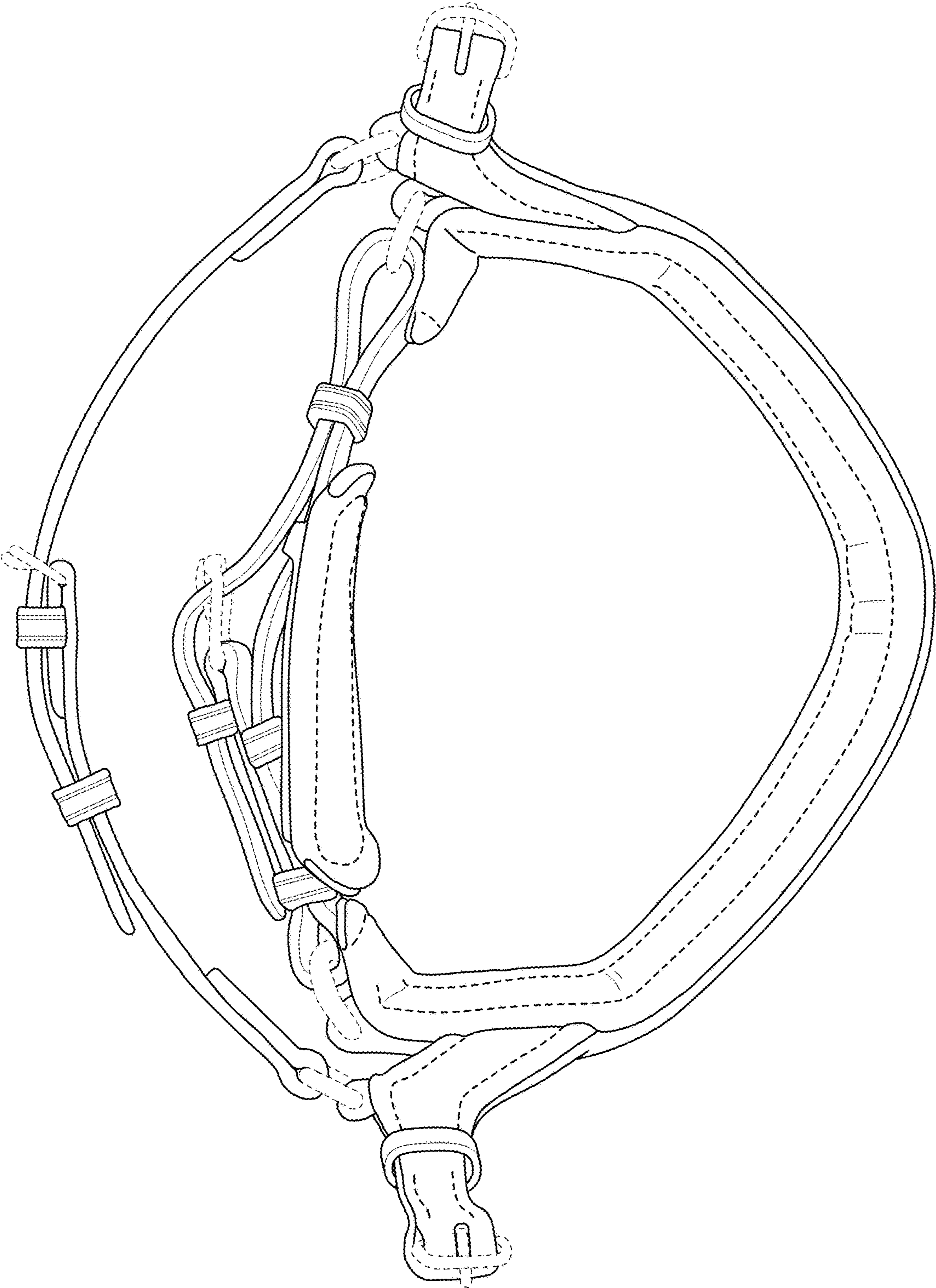

FIG. 6

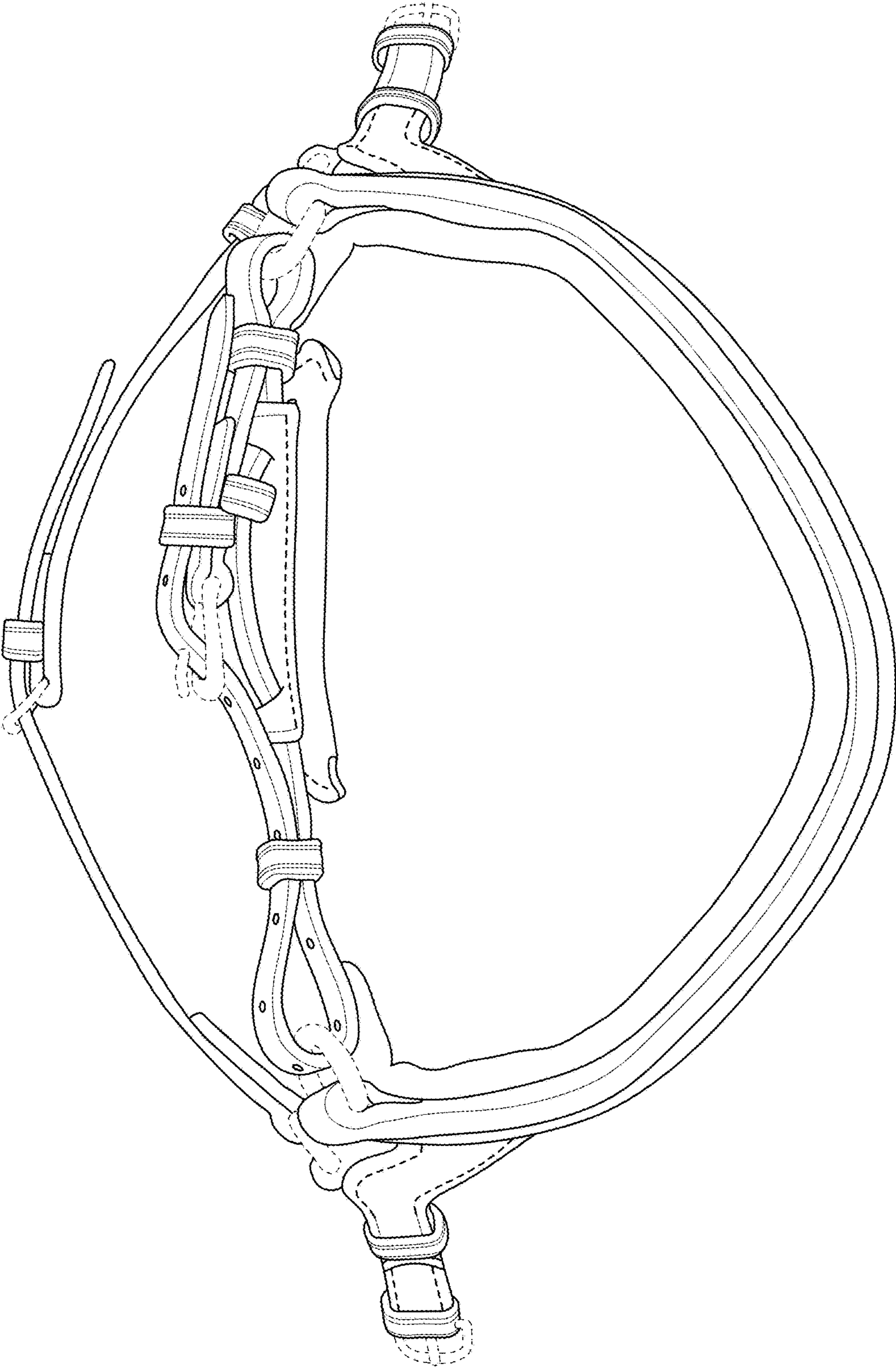

FIG. 7