



US00D801546S

(12) **United States Design Patent**
Johansson et al.

(10) **Patent No.:** **US D801,546 S**

(45) **Date of Patent:** **** *Oct. 31, 2017**

(54) **BOX FOR DENTAL INSTRUMENTS AND PARTS SET**

(71) Applicants: **Anders Johansson**, Göteborg (SE);
Henrik Johansson, Partille (SE);
Johan Bergelin, Lilla Edet (SE); **Ole Kristian Lund Bjerke**, Göteborg (SE)

(72) Inventors: **Anders Johansson**, Göteborg (SE);
Henrik Johansson, Partille (SE);
Johan Bergelin, Lilla Edet (SE); **Ole Kristian Lund Bjerke**, Göteborg (SE)

(73) Assignee: **DENTSPLY International Inc.**, York, PA (US)

(*) Notice: This patent is subject to a terminal disclaimer.

(**) Term: **14 Years**

(21) Appl. No.: **29/445,714**

(22) Filed: **Feb. 15, 2013**

(51) **LOC (10) Cl.** **24-02**

(52) **U.S. Cl.**
USPC **D24/229**

(58) **Field of Classification Search**
USPC D24/216, 224-232, 107; D9/737-738,
D9/732; 211/85.13, 74, 71.01; 422/500,
(Continued)

(56) **References Cited**

U.S. PATENT DOCUMENTS

D264,810 S * 6/1982 Voltmann D3/203.3
D282,577 S * 2/1986 Neumeister D24/226
(Continued)

Primary Examiner — T. Chase Nelson

Assistant Examiner — Mark Cavanna

(74) *Attorney, Agent, or Firm* — David A. Zdurne;
Douglas J. Hura; Leana Levin

(57) **CLAIM**

The ornamental design for a box for dental instruments and parts set, as shown and described.

DESCRIPTION

FIG. 1 is a top perspective view of the closed box element of a box for dental instruments and parts set showing our new design;
FIG. 2 is a bottom perspective view thereof;
FIG. 3 is a front plan view thereof;
FIG. 4 is a top plan view thereof;
FIG. 5 is a right side view thereof;
FIG. 6 is a rear plan view thereof;
FIG. 7 is a bottom plan view thereof;
FIG. 8 is a left side view thereof;
FIG. 9 is a top perspective view of the opened box element shown in FIG. 1 of the box for dental instruments and parts set with an insert element;
FIG. 10 is a bottom perspective view thereof;
FIG. 11 is a top plan view thereof;
FIG. 12 is a rear plan view thereof;
FIG. 13 is a left side view thereof with the right side view being a mirror view of the left side;
FIG. 14 is a bottom plan view thereof;
FIG. 15 is a front elevational plan view elevational thereof;
FIG. 16 is a top perspective view of the bottom portion of the box element of the box for dental instruments and parts set shown in FIG. 1 shown with no insert;
FIG. 17 is a bottom perspective view thereof;
FIG. 18 is a front elevational view elevational thereof;
FIG. 19 is a top plan view thereof;
FIG. 20 is a right side elevational view thereof;
FIG. 21 is a rear elevational view thereof;
FIG. 22 is a bottom plan view thereof;
FIG. 23 is a left side elevational;
FIG. 24 is a top perspective view of the insert element of the box for dental instruments and parts set shown in FIG. 9;
FIG. 25 is a top plan view thereof;
FIG. 26 is a rear elevational view thereof;
FIG. 27 is a right side elevational view thereof;
FIG. 28 is a front plan view thereof;
FIG. 29 is a left side elevational view thereof;

(Continued)

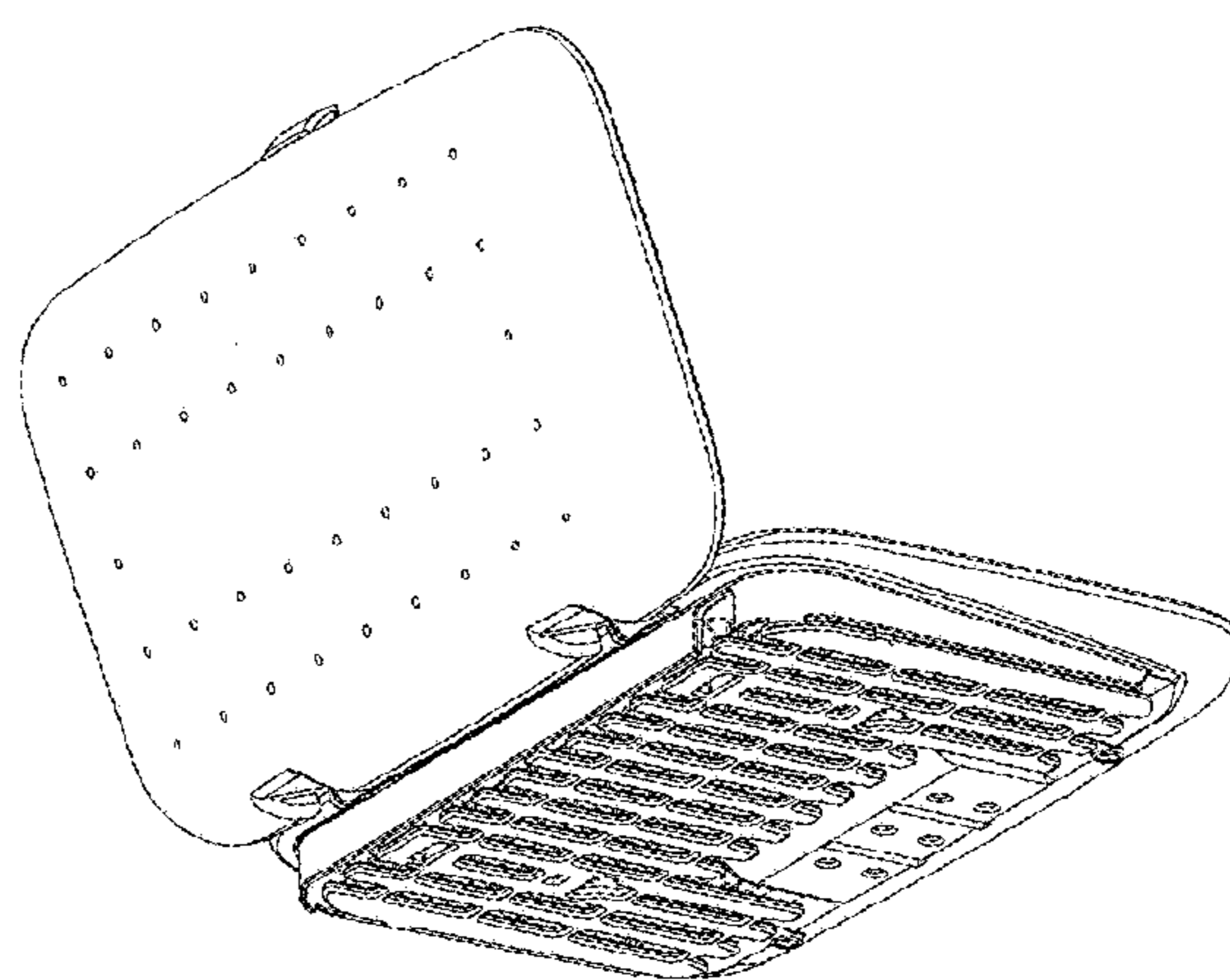
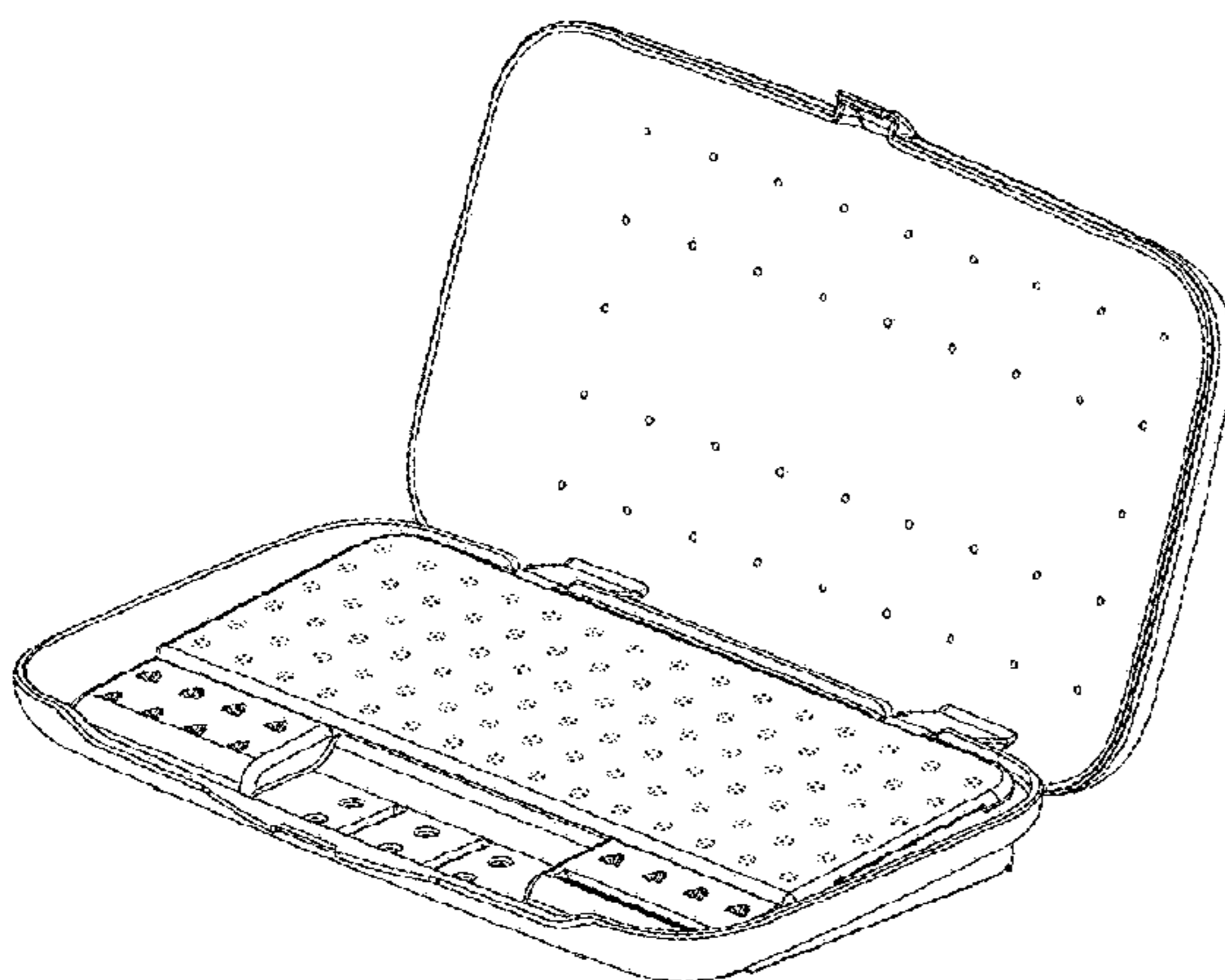

FIG. 30 is a bottom plan view thereof;
 FIG. 31 is a top perspective view of another insert element of the box for dental instruments and parts set;
 FIG. 32 is a top plan view thereof;
 FIG. 33 is a rear elevational view thereof;
 FIG. 34 is a right side elevational view thereof;
 FIG. 35 is a front plan view thereof;
 FIG. 36 is a left side elevational view thereof;
 FIG. 37 is a bottom plan view thereof;
 FIG. 38 is a top perspective view of another insert element of the box for dental instruments and parts set;
 FIG. 39 is a top plan view thereof;
 FIG. 40 is a rear elevational view thereof;
 FIG. 41 is a right side elevational view thereof;
 FIG. 42 is a front elevational view thereof;
 FIG. 43 is a left side elevational view thereof;
 FIG. 44 is a bottom plan view thereof;
 FIG. 45 is a top perspective view of another insert element of the box for dental instruments and parts set;
 FIG. 46 is a top elevational plan view thereof;
 FIG. 47 is a rear elevational view thereof;
 FIG. 48 is a right side elevational view thereof;
 FIG. 49 is a front elevational view thereof;
 FIG. 50 is a left side elevational view thereof;
 FIG. 51 is a bottom plan view thereof; and,
 FIG. 52 is an exploded perspective view of the box element shown in FIG. 9 of the box for dental instruments and parts set with another bottom element for the box element with another insert.
 The broken lines immediately adjacent the claimed areas represent the bounds of the claim, and all other broken lines are included for the purpose of illustrating portions of the

present invention that form no part of the claimed design. None of the broken lines form part of the claimed design.

1 Claim, 26 Drawing Sheets

(58) **Field of Classification Search**

USPC 422/547-554, 560-566, 297, 300;
 D3/203.1-203.8, 304, 313, 314; 206/443,
 206/562-563, 368, 370, 536, 538;
 D6/468; 40/324; 600/556, 566

See application file for complete search history.

(56) **References Cited**

U.S. PATENT DOCUMENTS

4,593,819	A *	6/1986	Will	206/538
D324,819	S *	3/1992	Eisenberg	D3/203.3
D371,444	S *	7/1996	Madjar	D24/227
D423,111	S *	4/2000	Davis et al.	D24/226
6,875,405	B1 *	4/2005	Mathus et al.	422/562
D518,288	S *	4/2006	Shoemaker et al.	D3/203.7
D526,064	S *	8/2006	Wood	D24/229
D529,622	S *	10/2006	Hadjis et al.	D24/229
7,150,355	B2 *	12/2006	Coe et al.	206/536
D543,120	S *	5/2007	Coe et al.	D9/732
D563,561	S *	3/2008	Faust et al.	D24/229
D574,505	S *	8/2008	Muller-Cohn et al.	D24/216
D593,207	S *	5/2009	Ayliffe	D24/229
D608,458	S *	1/2010	Carlson	D24/230
2004/0238390	A1 *	12/2004	Barnes	206/368
2005/0173278	A1 *	8/2005	Caron	206/370

* cited by examiner

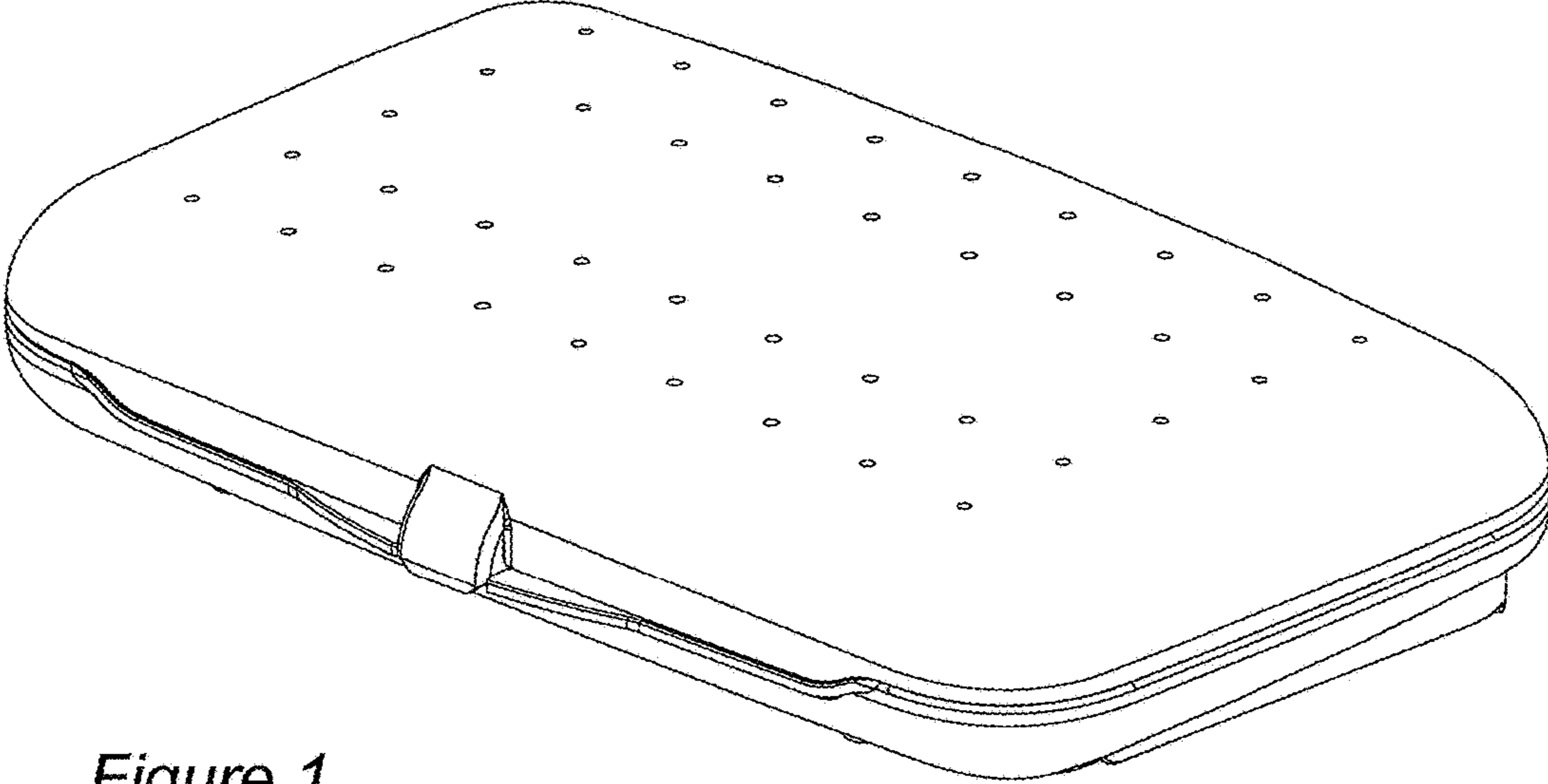

Figure 1

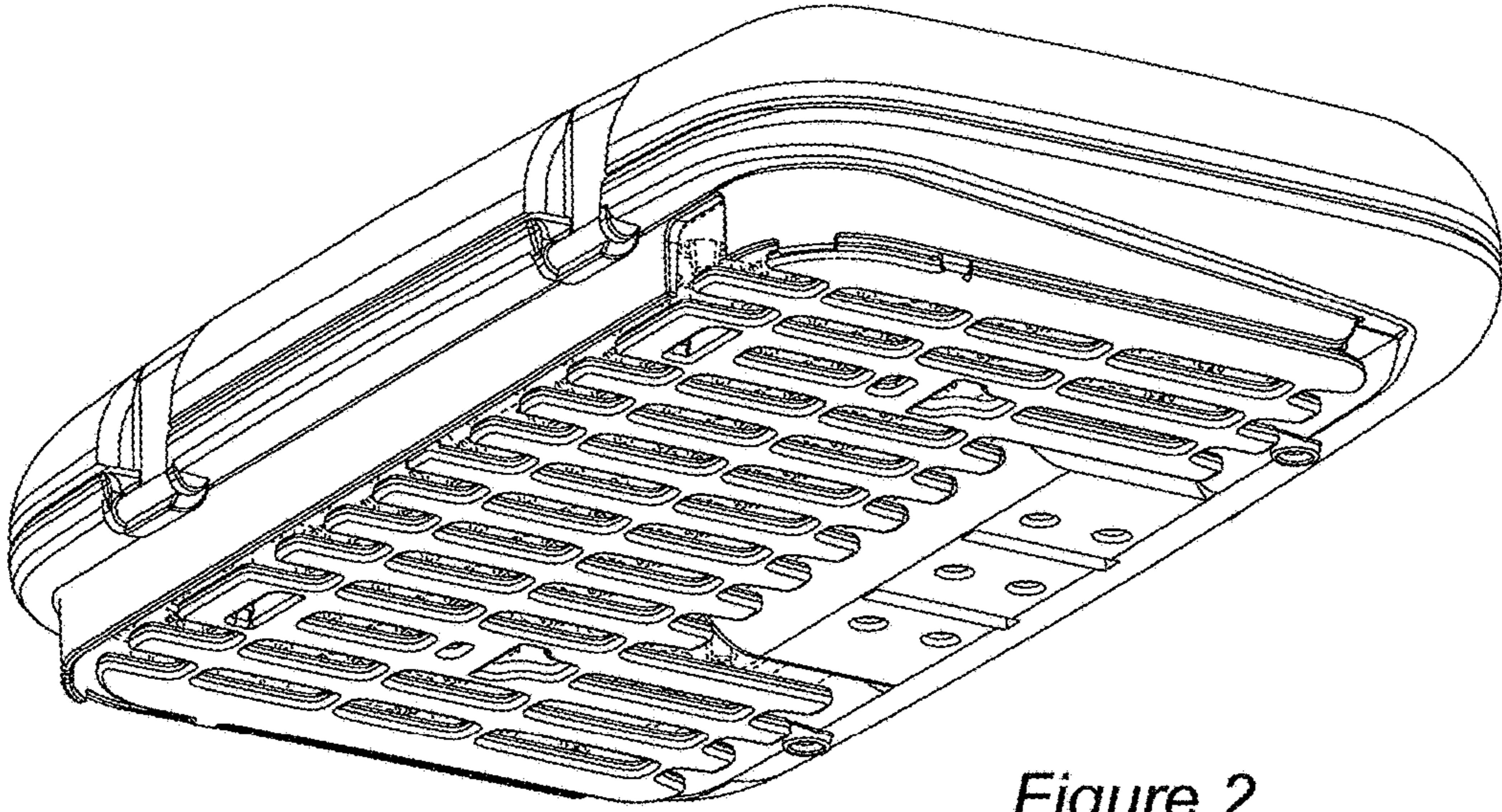

Figure 2

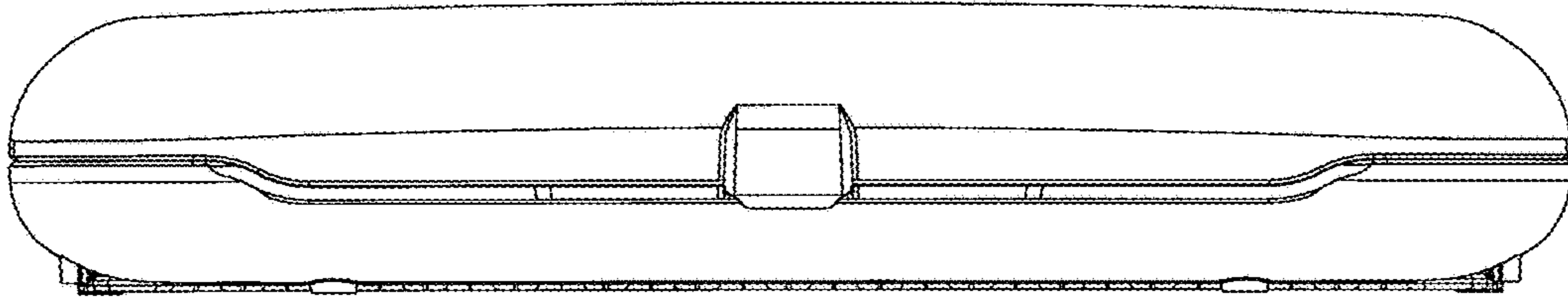

Figure 3

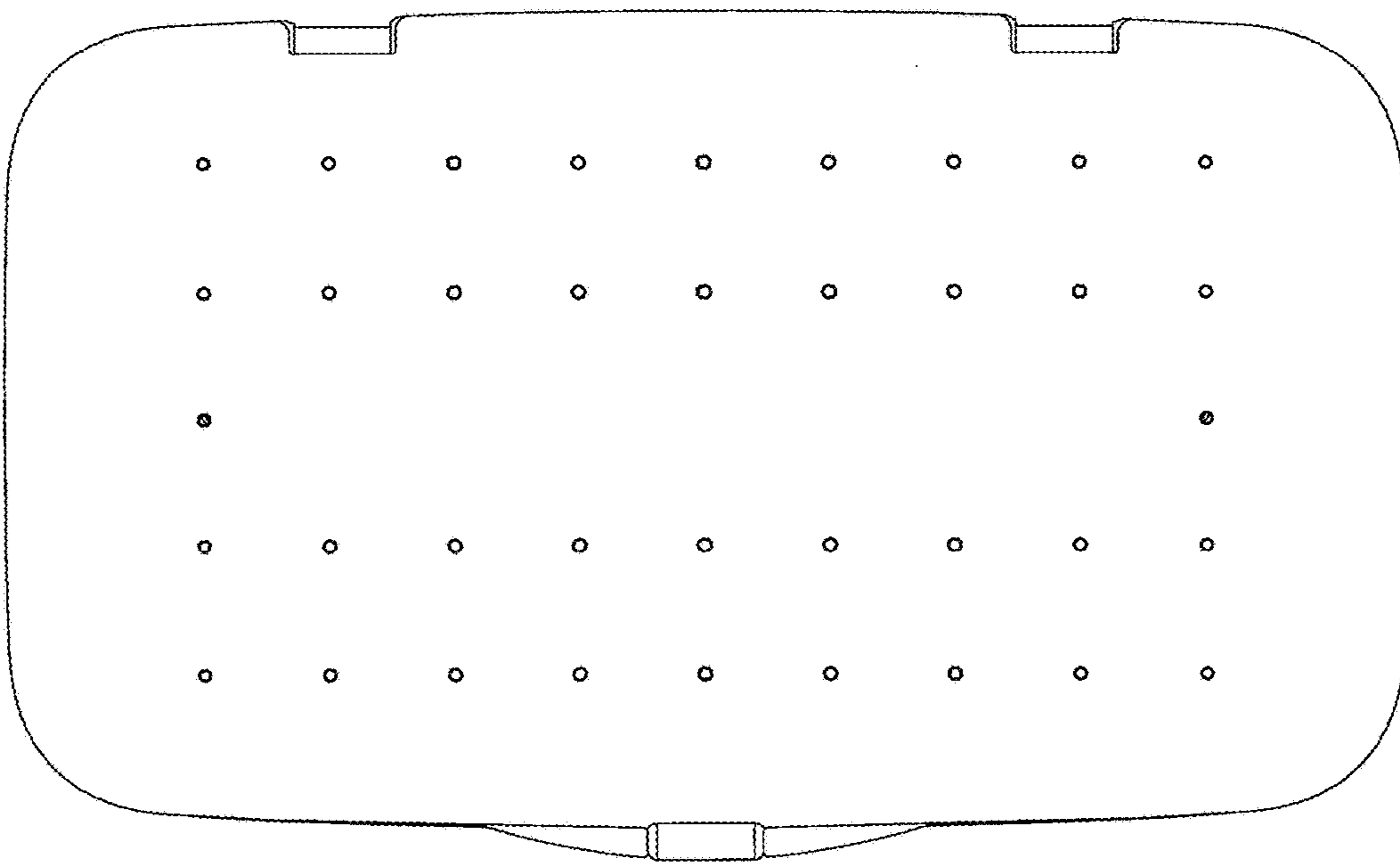

Figure 4

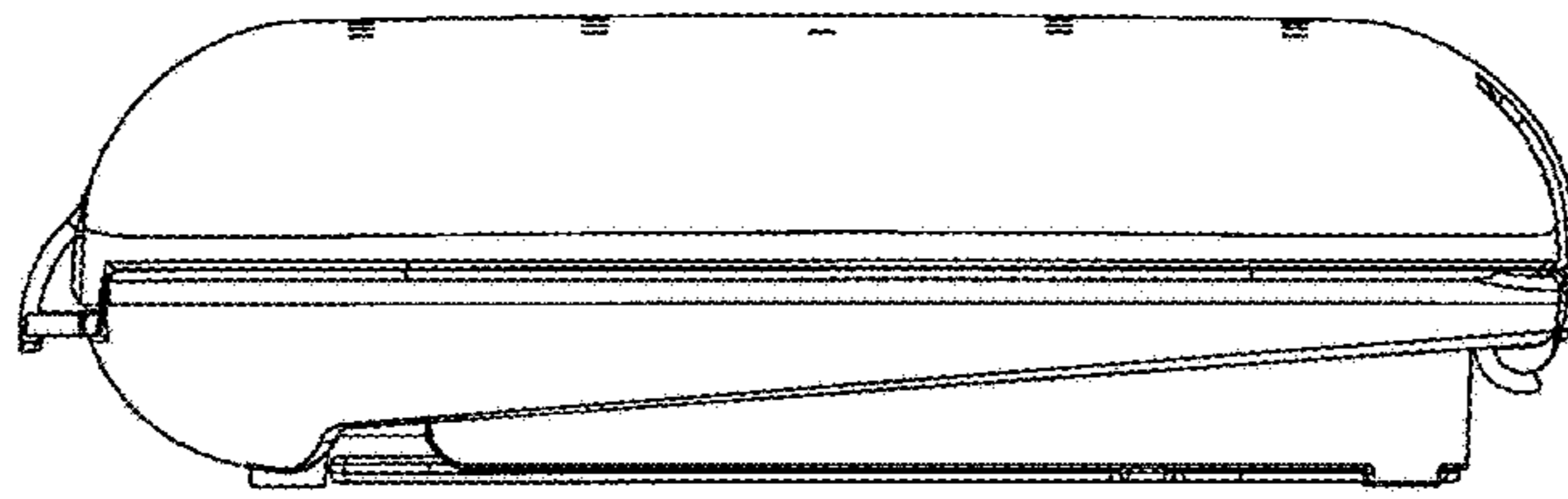

Figure 5

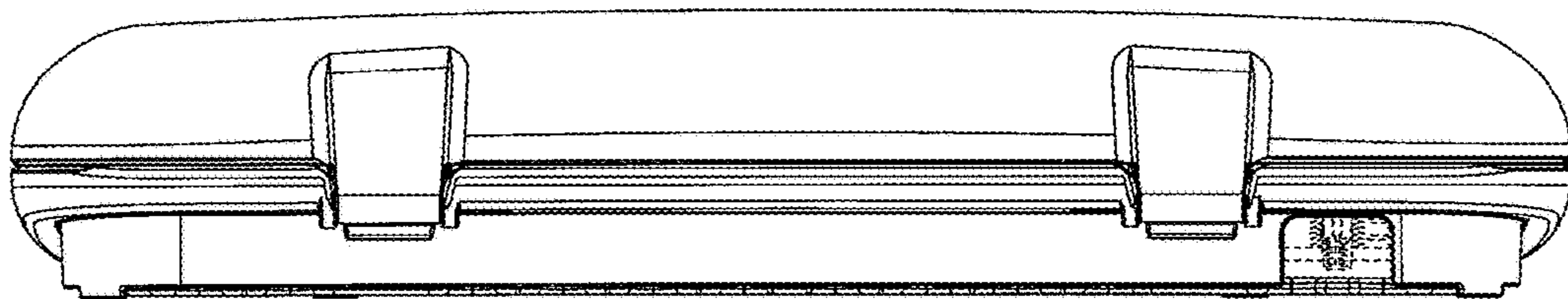

Figure 6

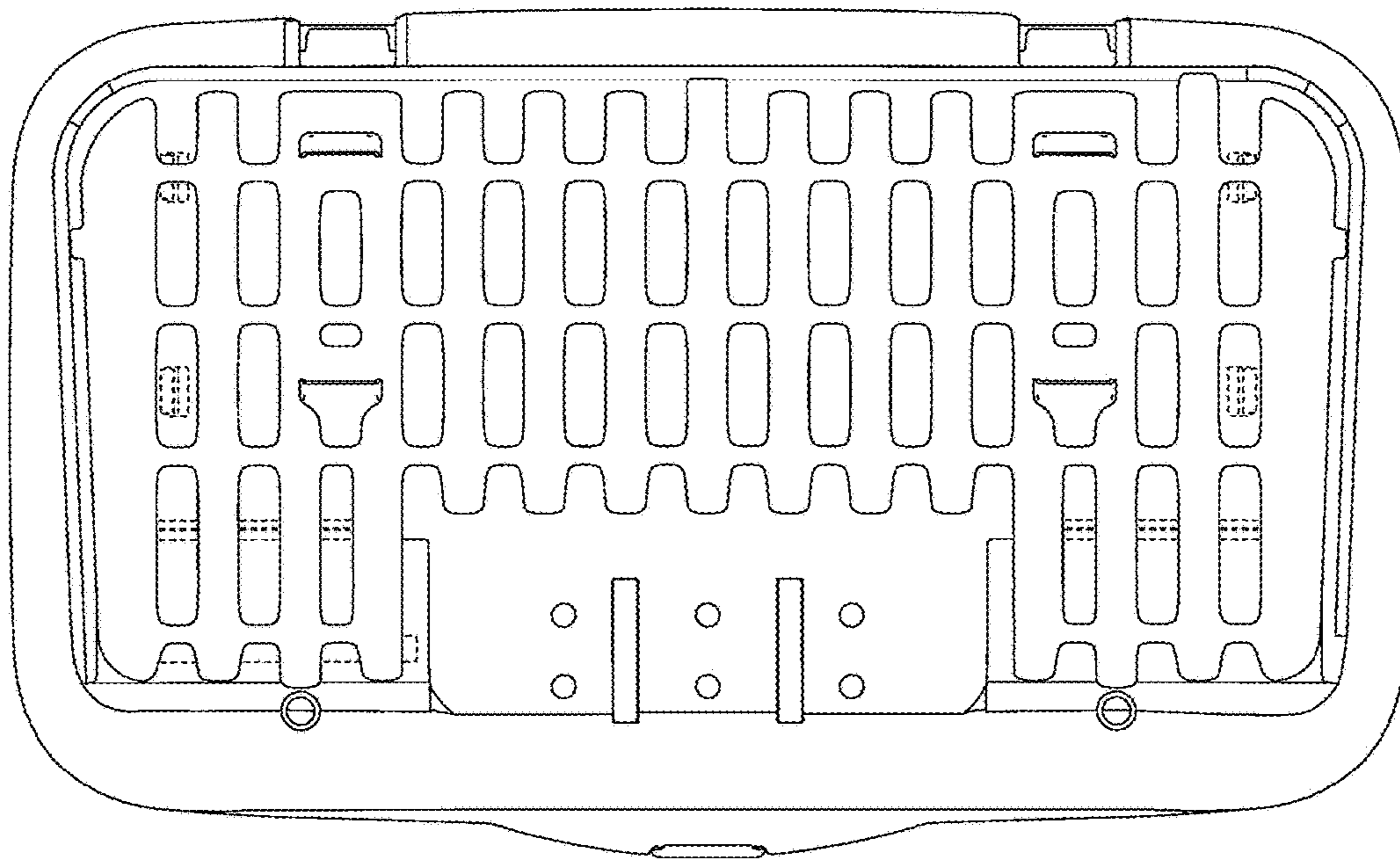

Figure 7

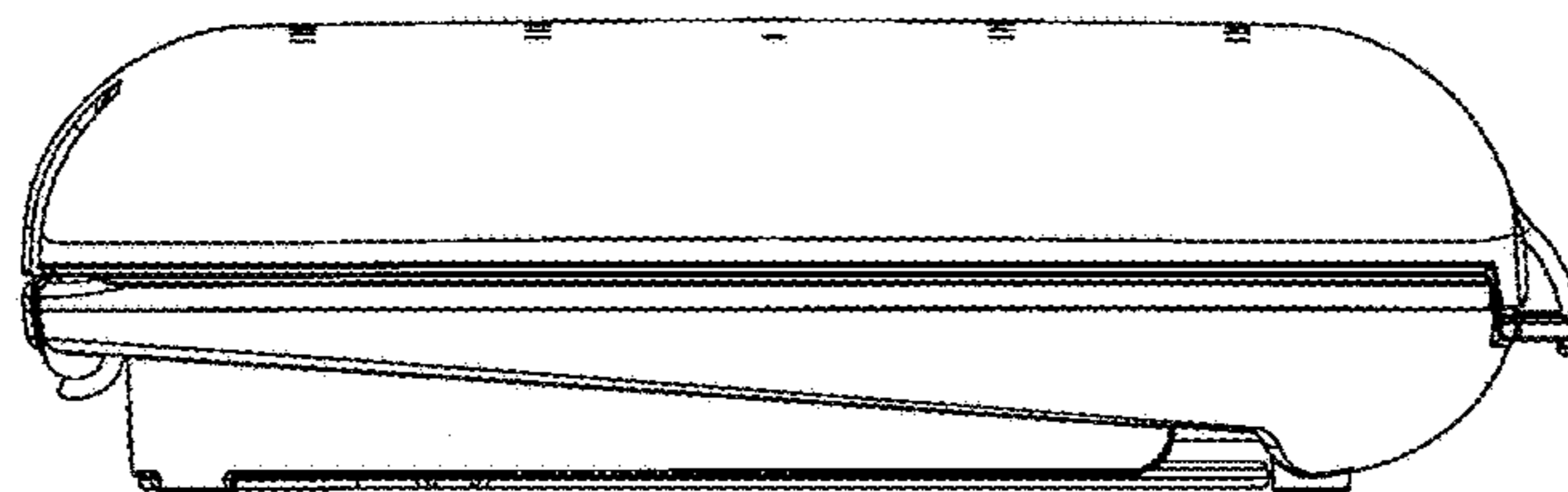

Figure 8

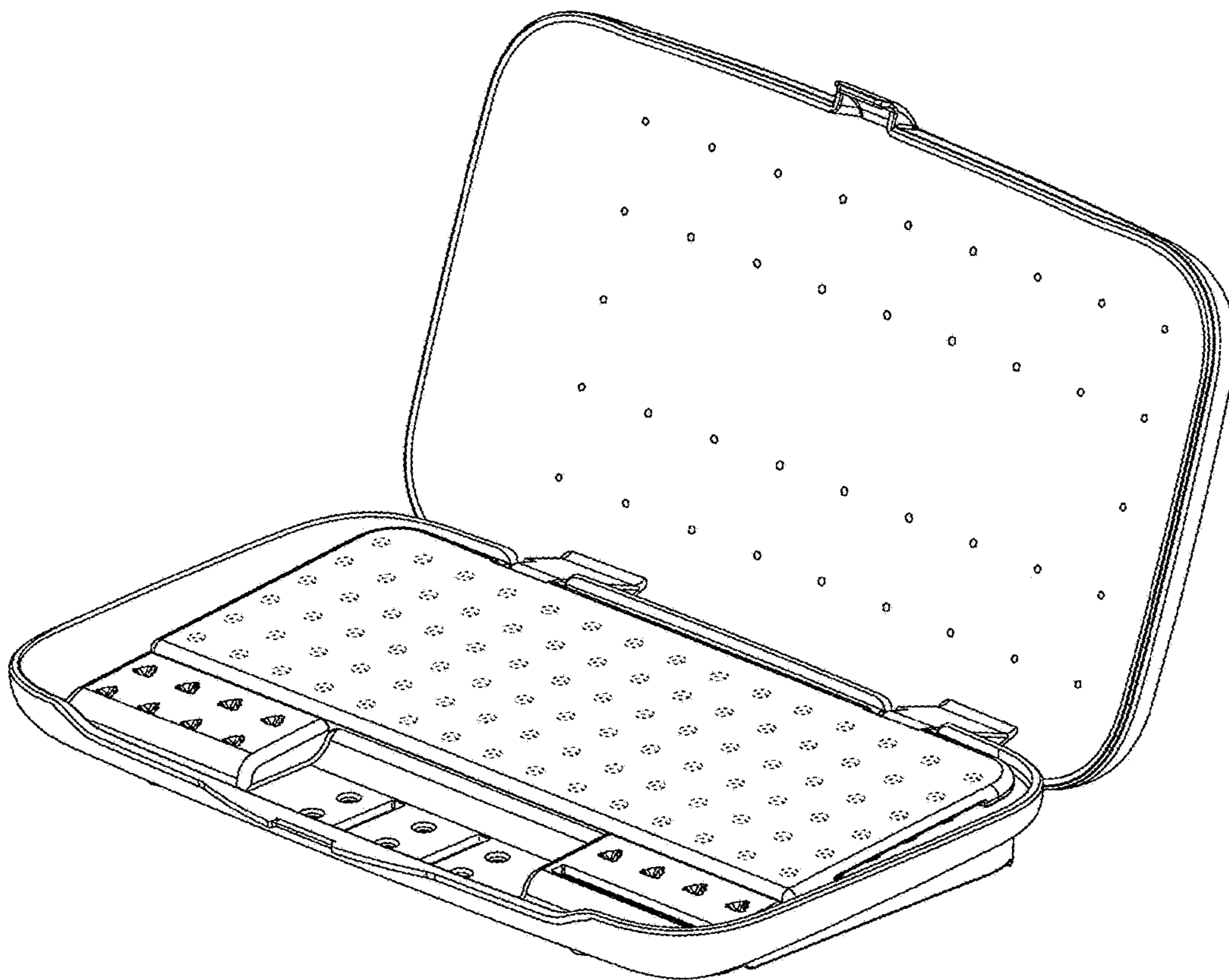

Figure 9

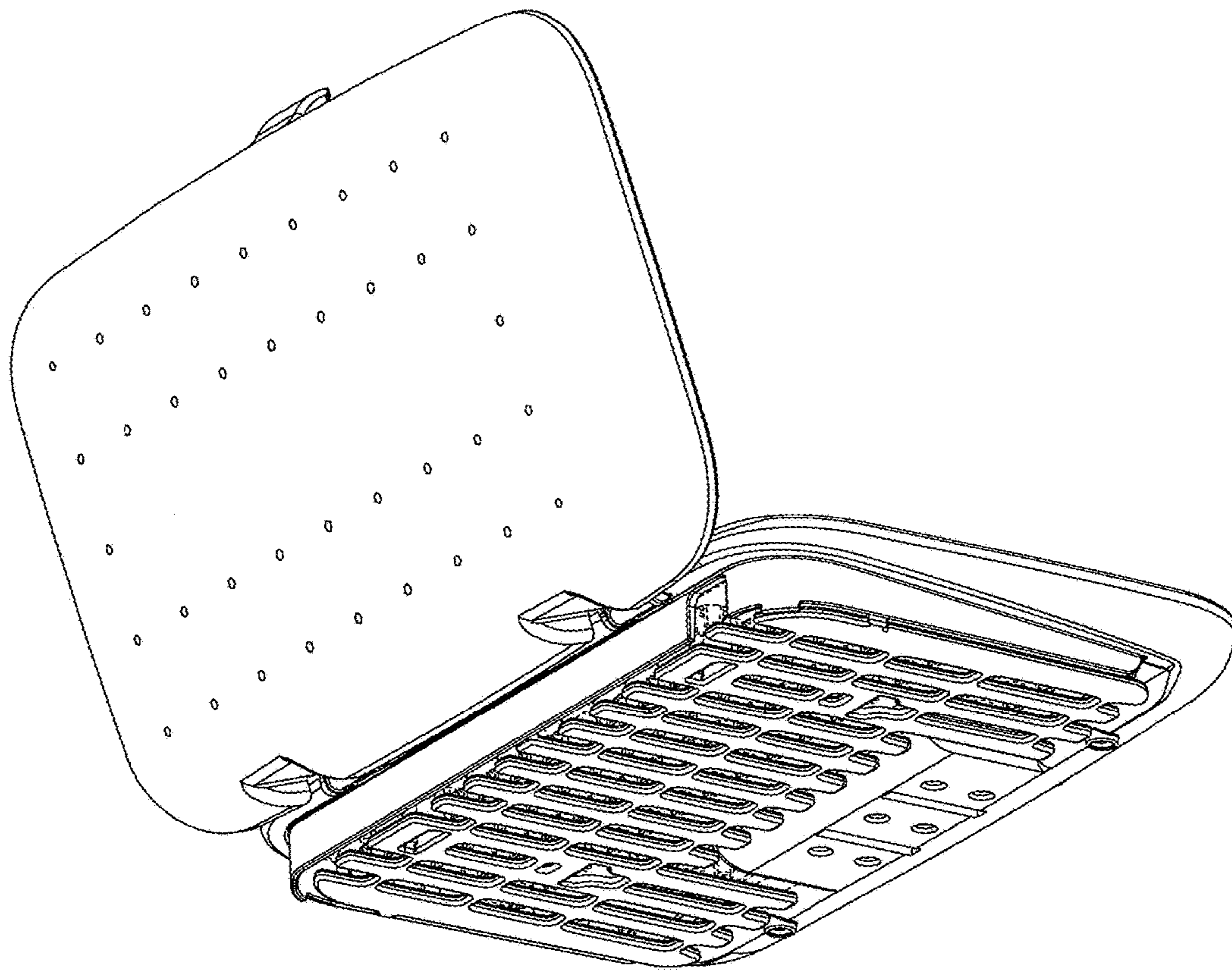

Figure 10

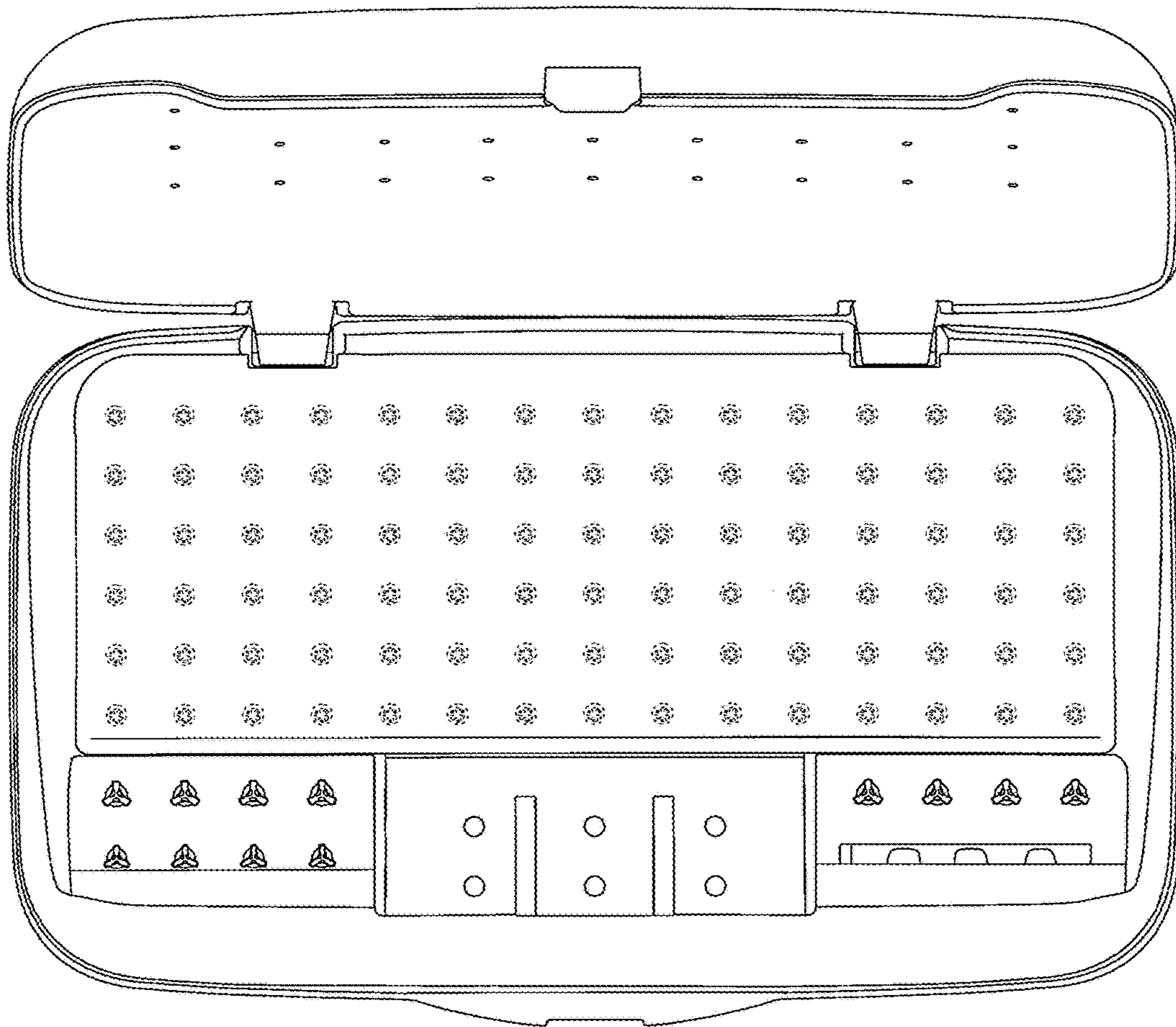

Figure 11

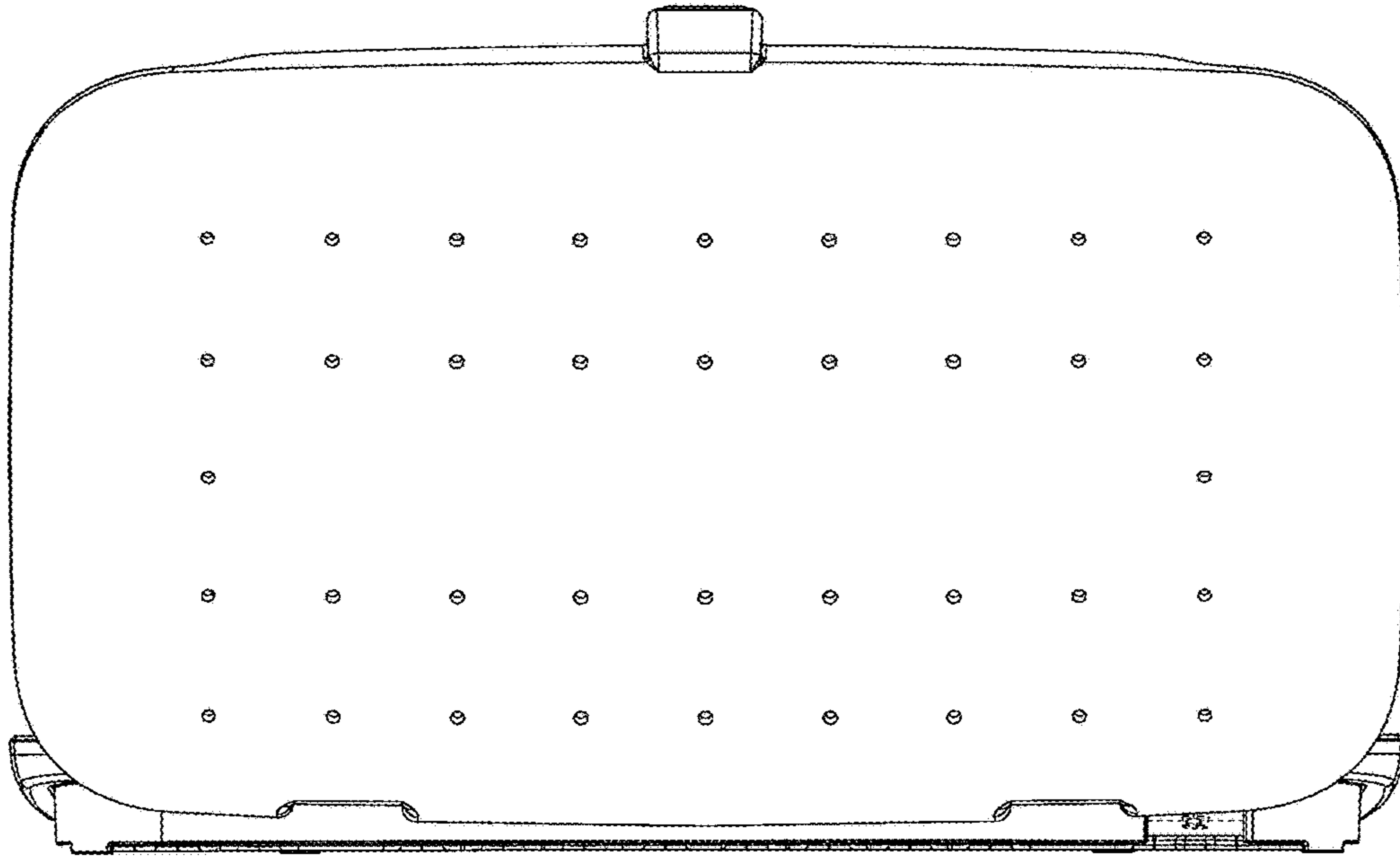

Figure 12

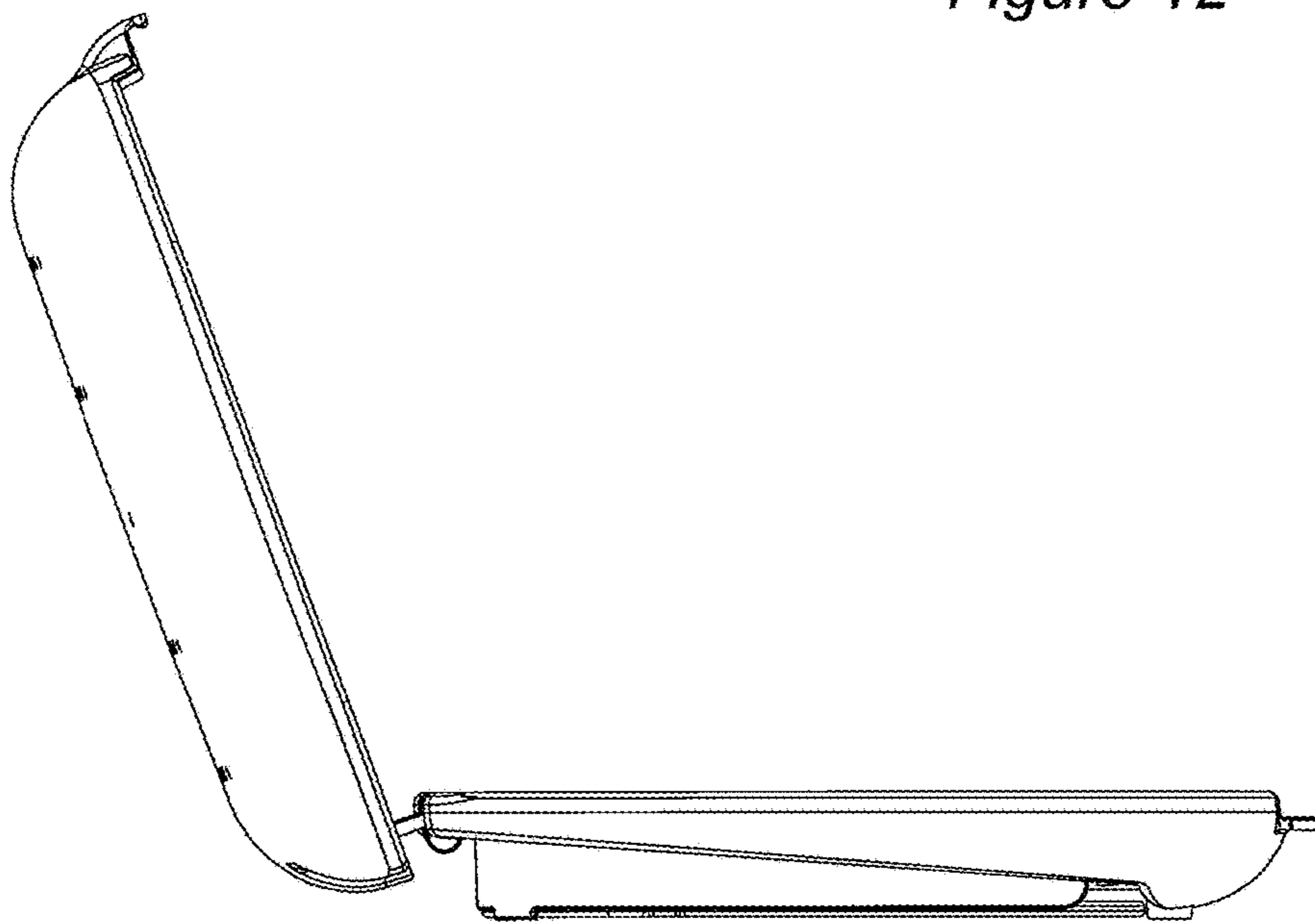

Figure 13

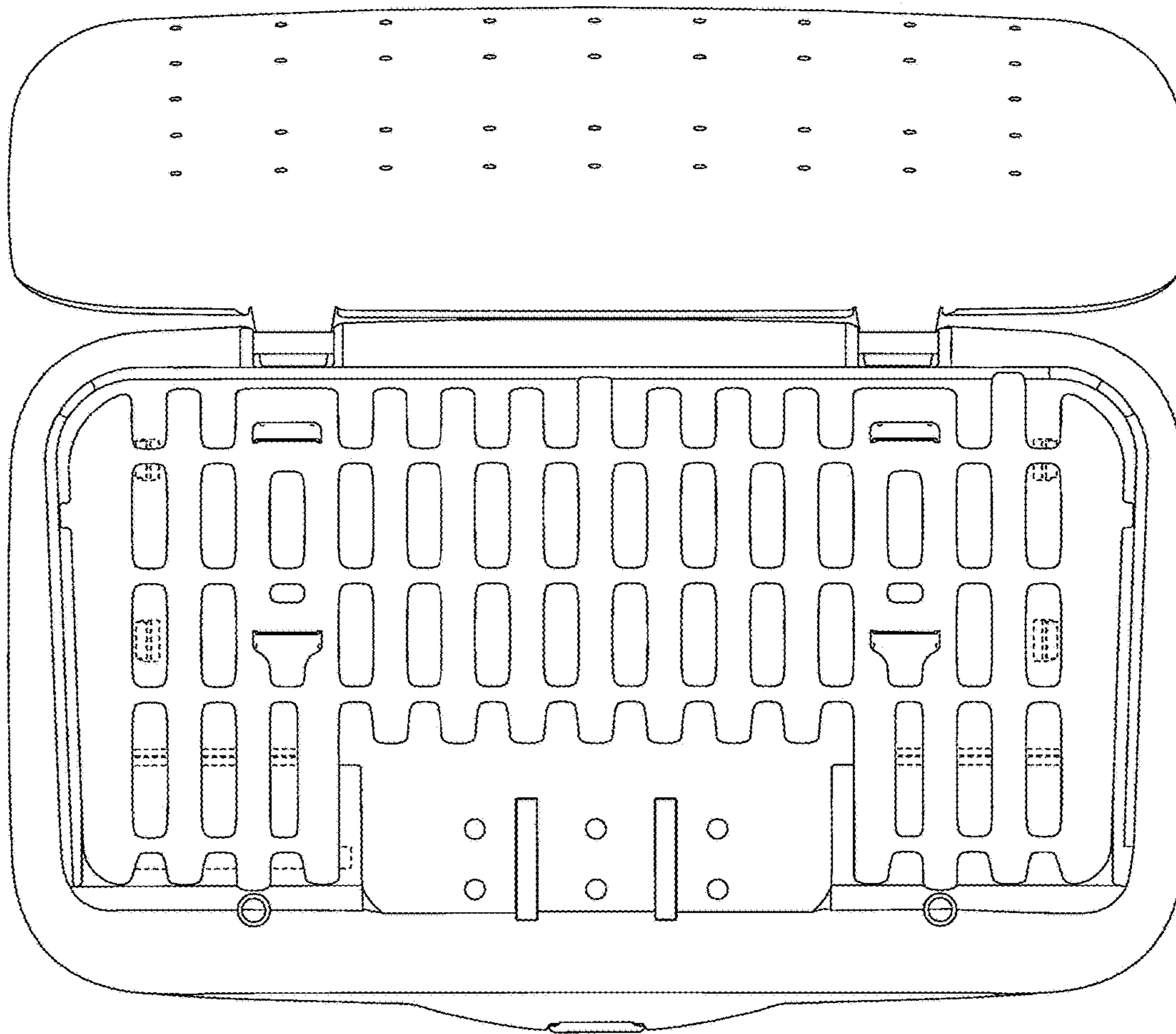

Figure 14

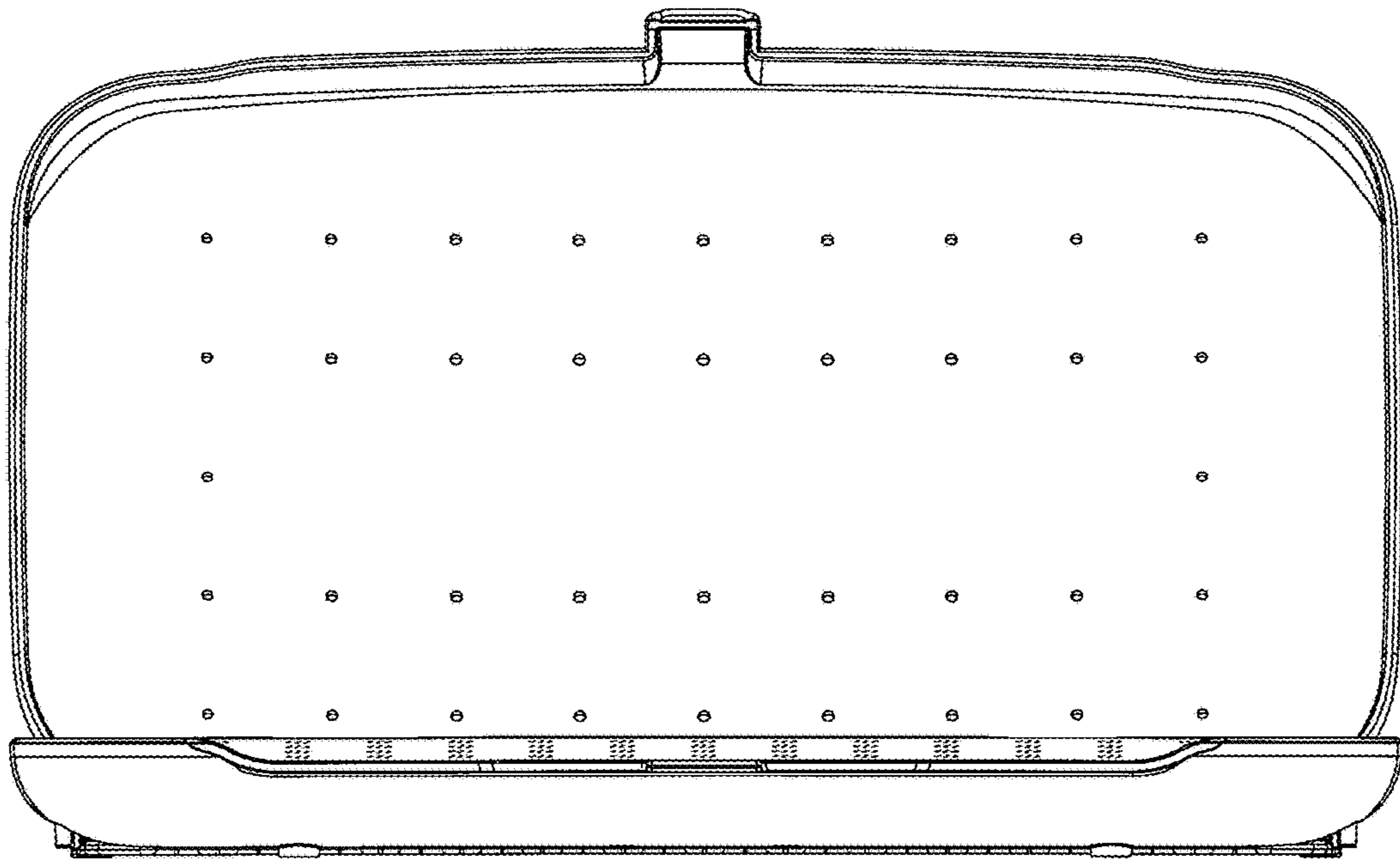

Figure 15

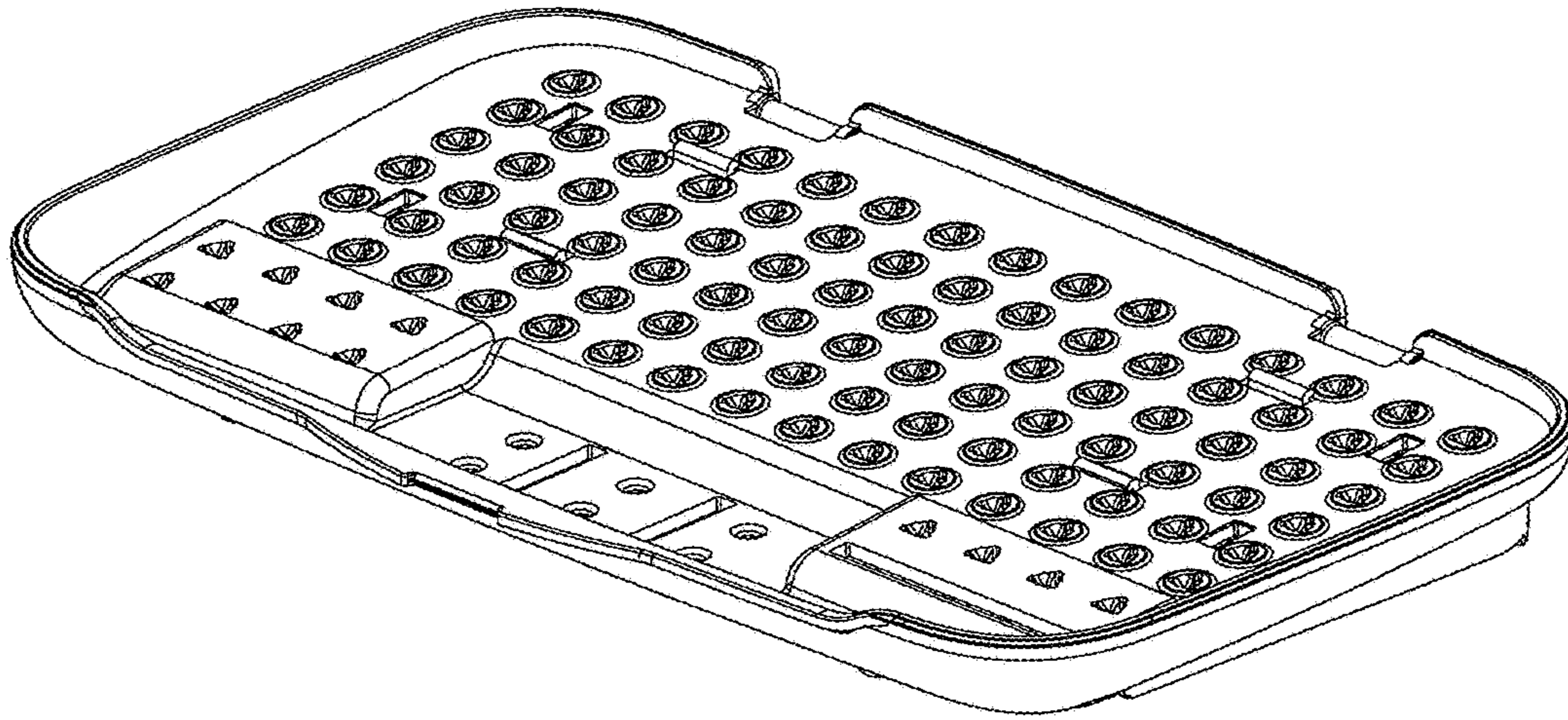

Figure 16

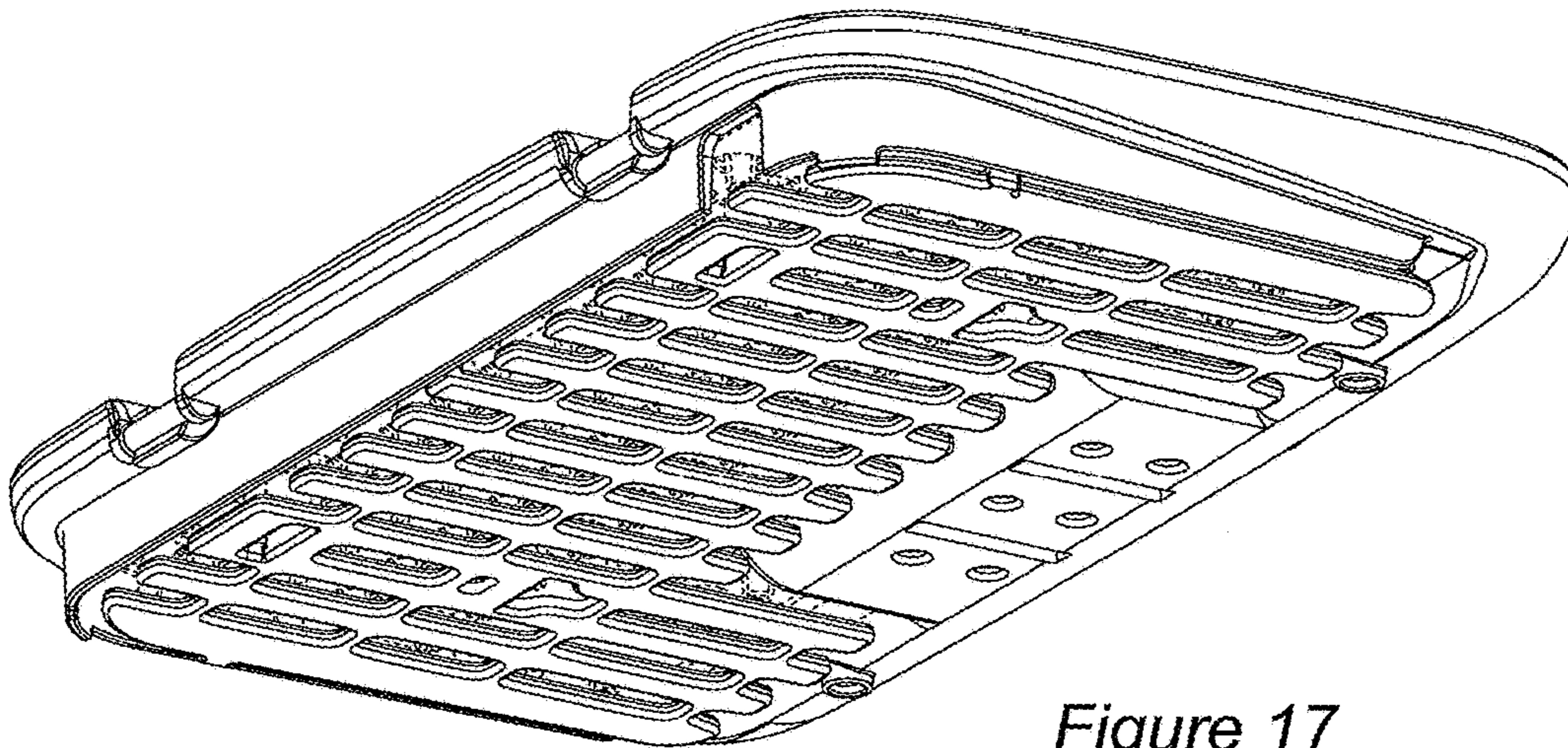

Figure 17

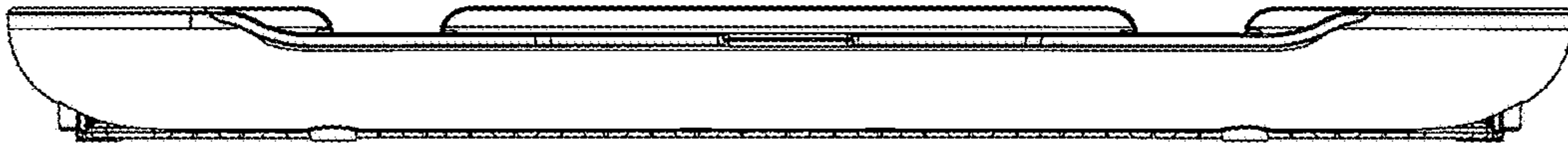

Figure 18

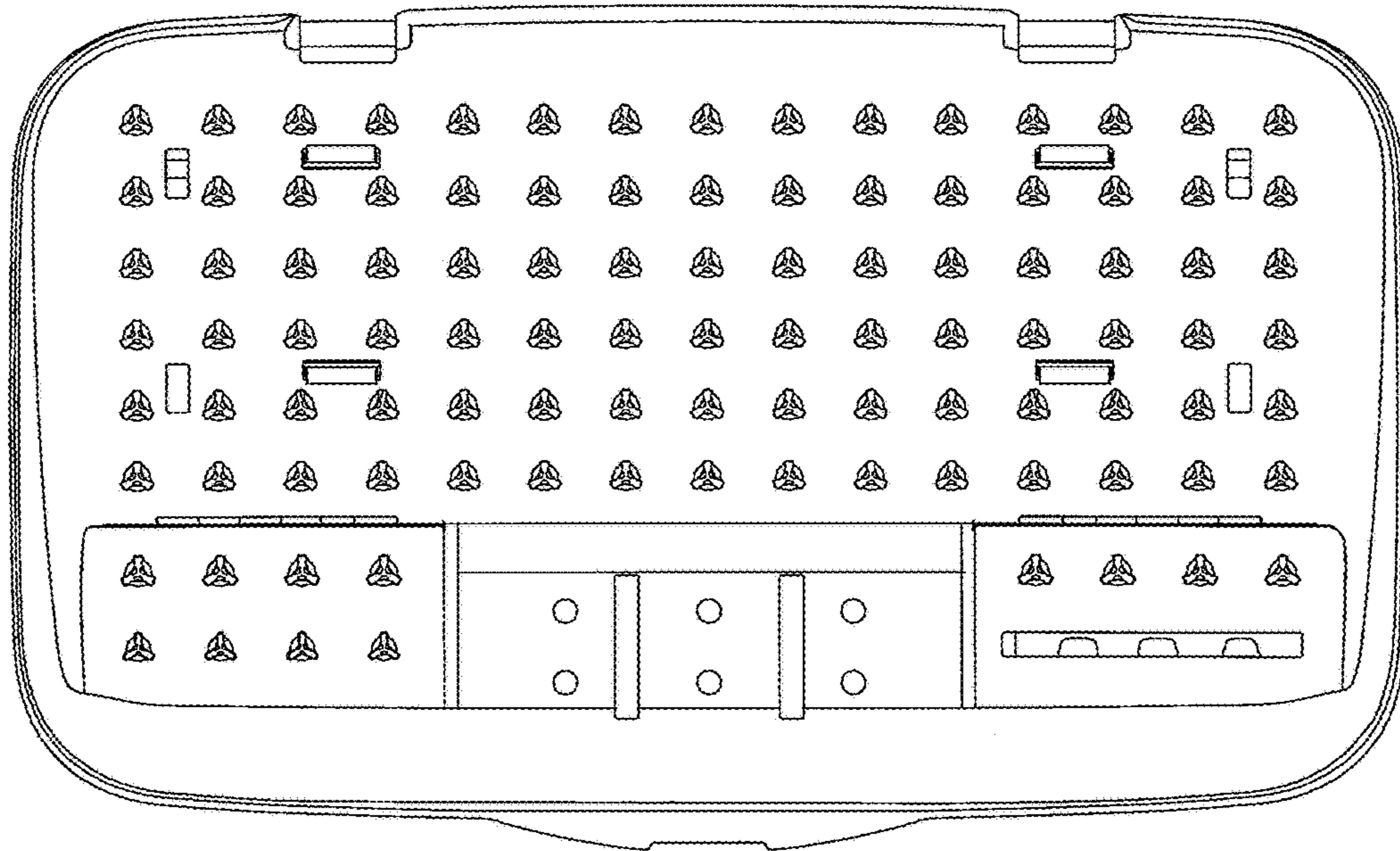

Figure 19

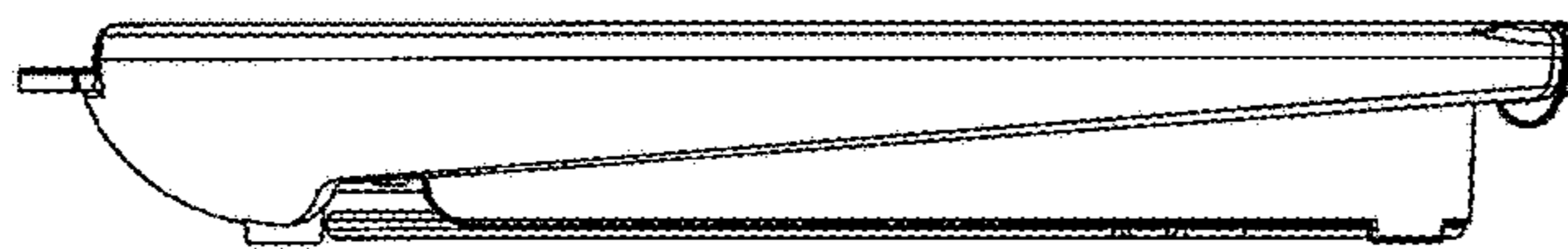

Figure 20

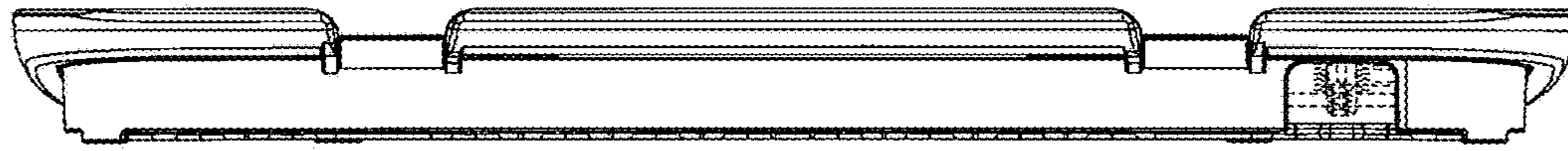

Figure 21

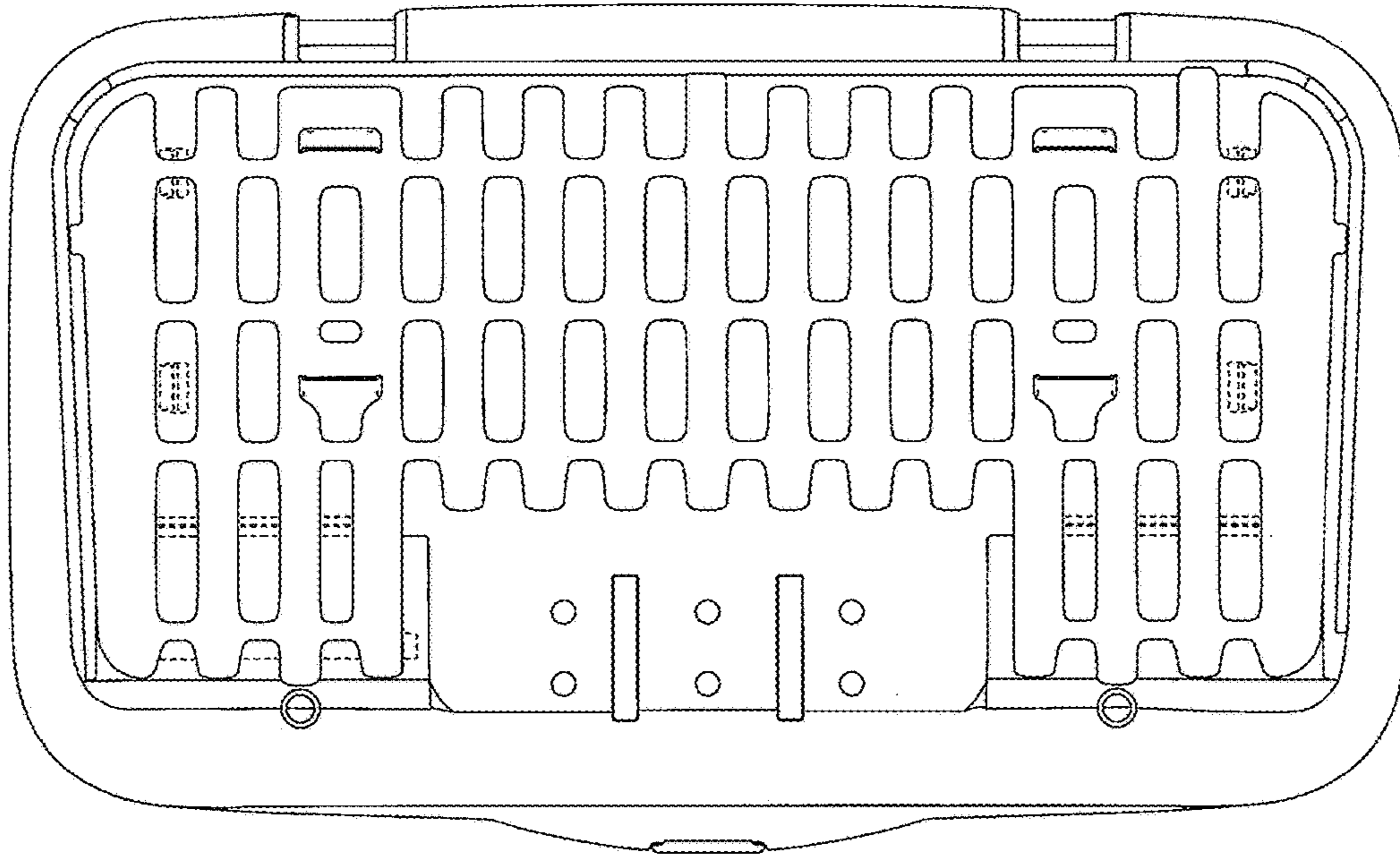

Figure 22

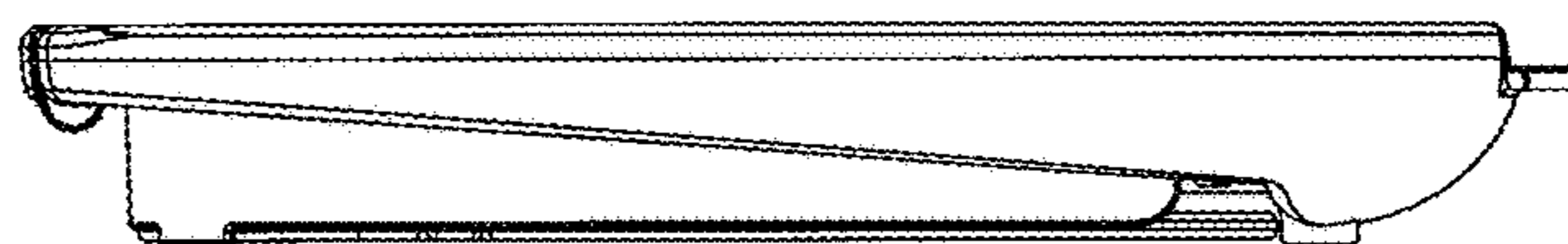

Figure 23

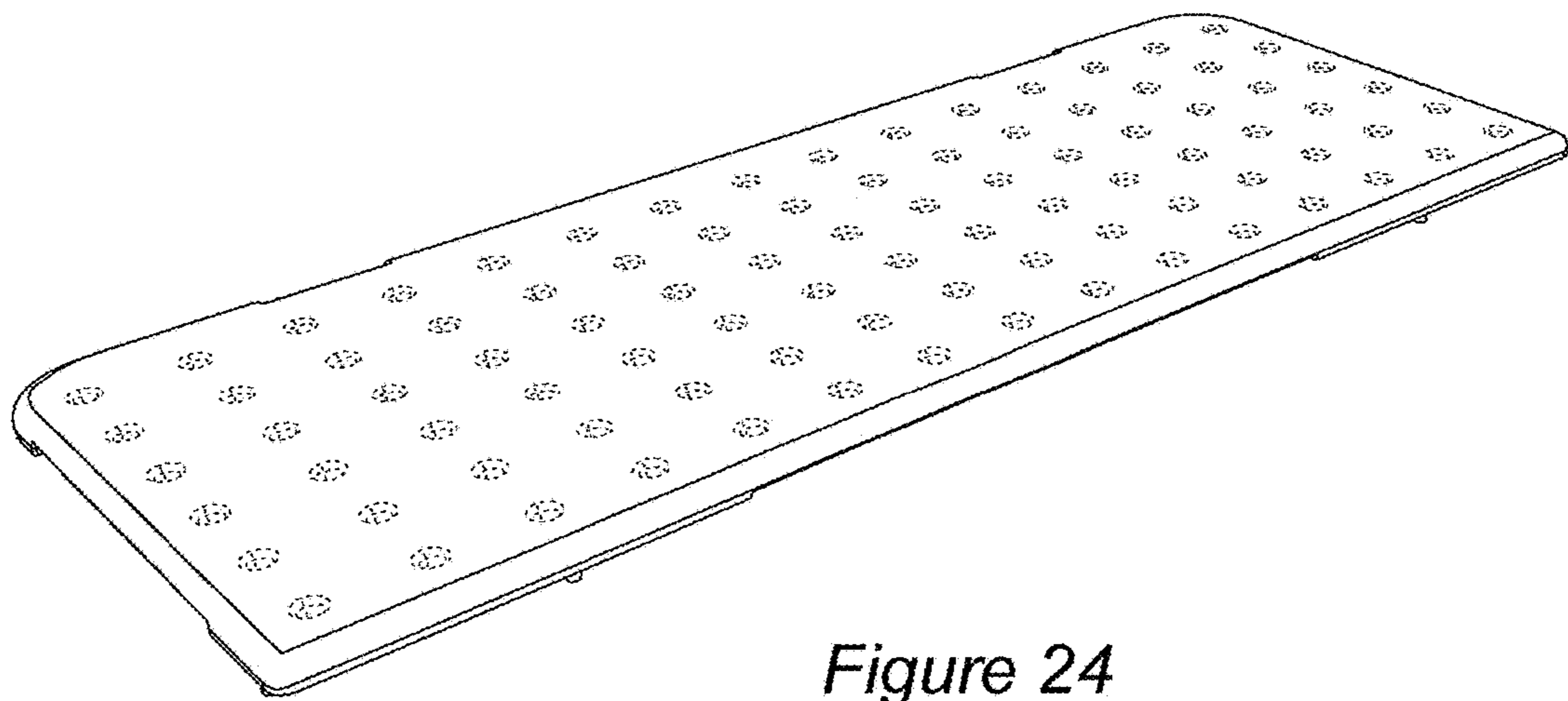

Figure 24

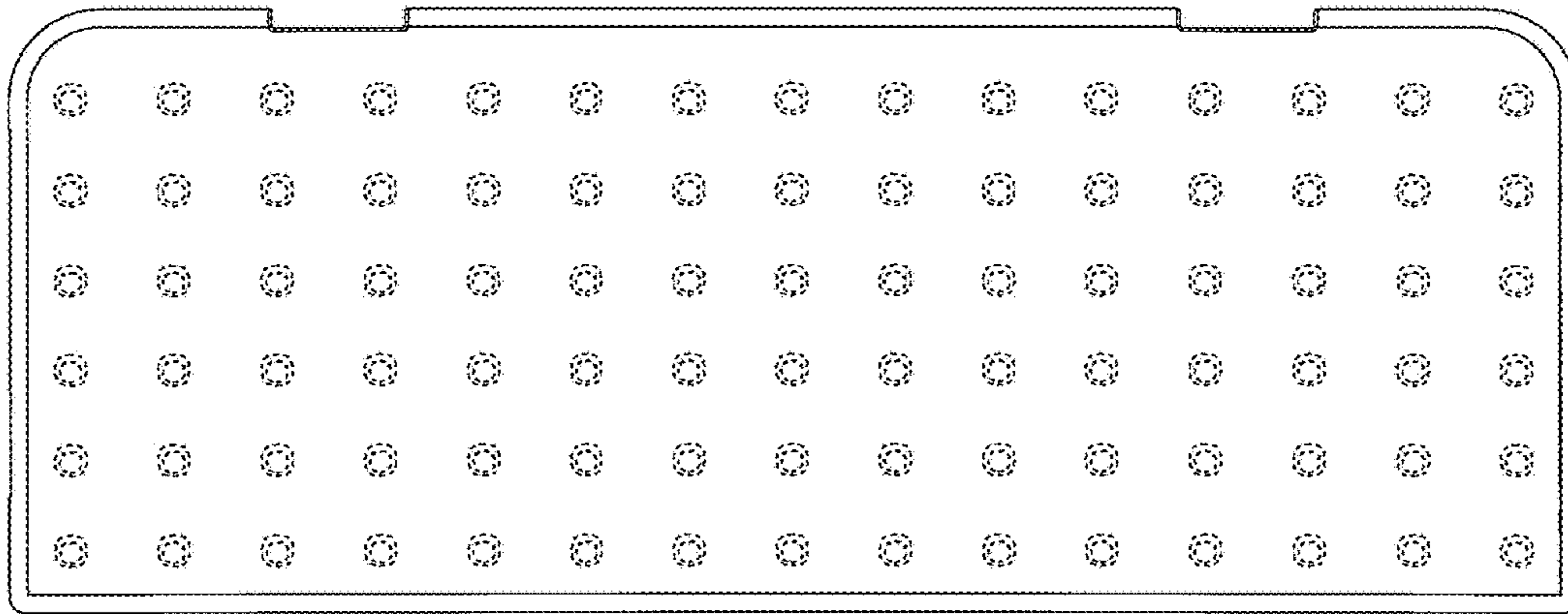

Figure 25

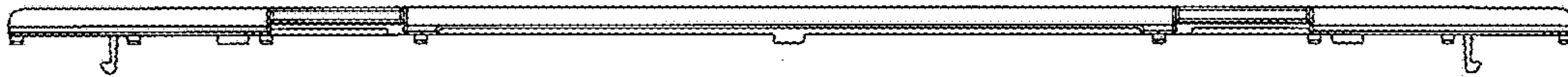

Figure 26

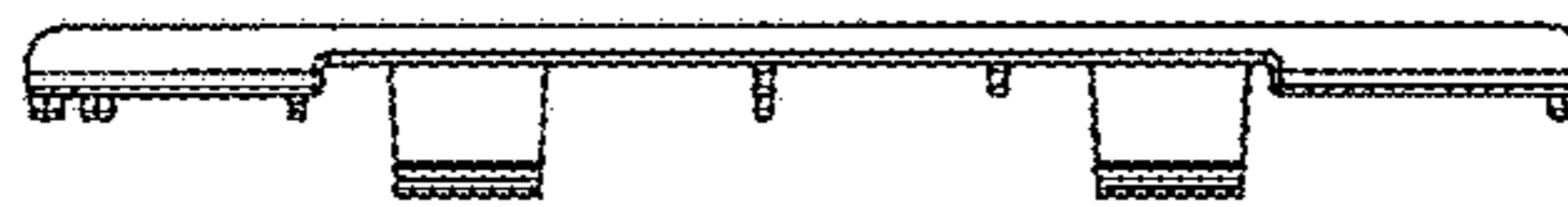

Figure 27



Figure 28

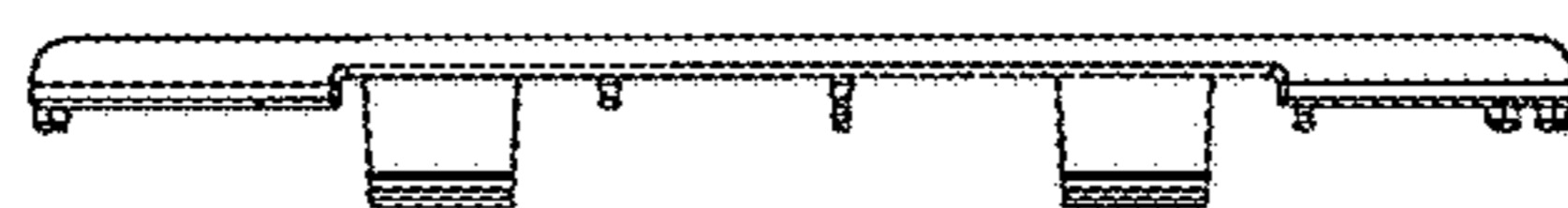

Figure 29

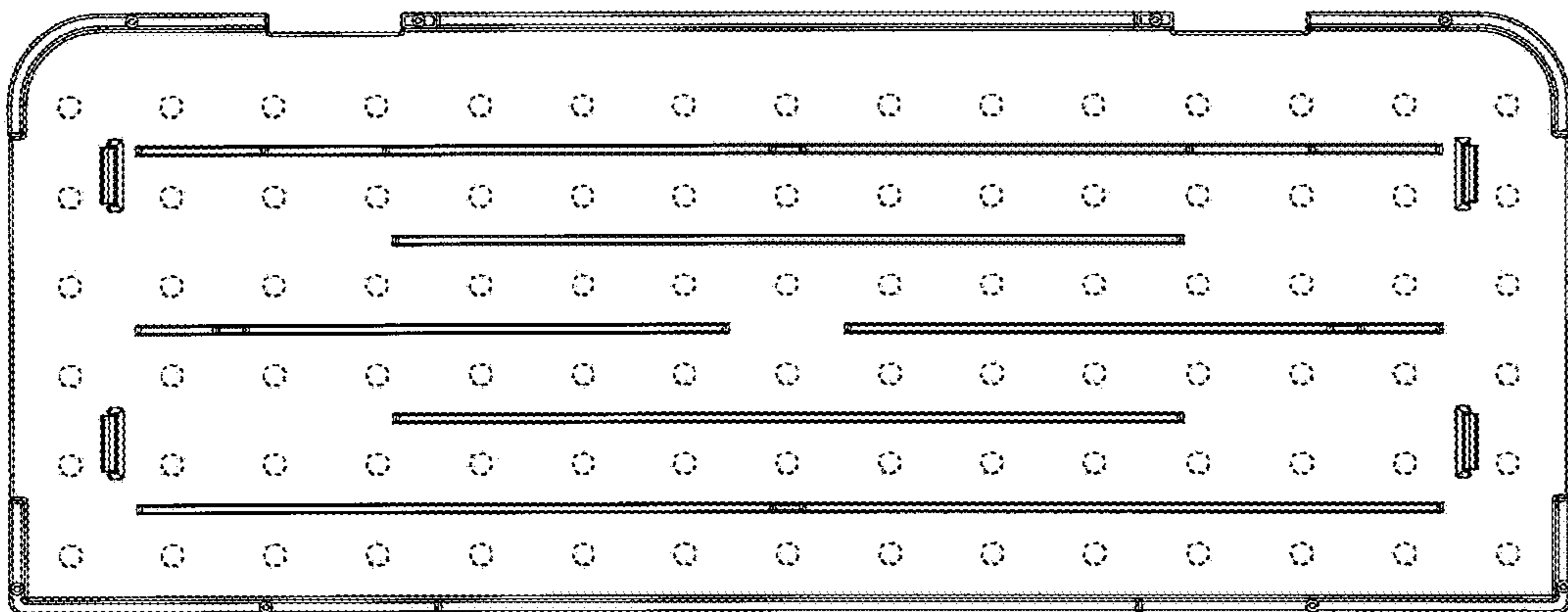

Figure 30

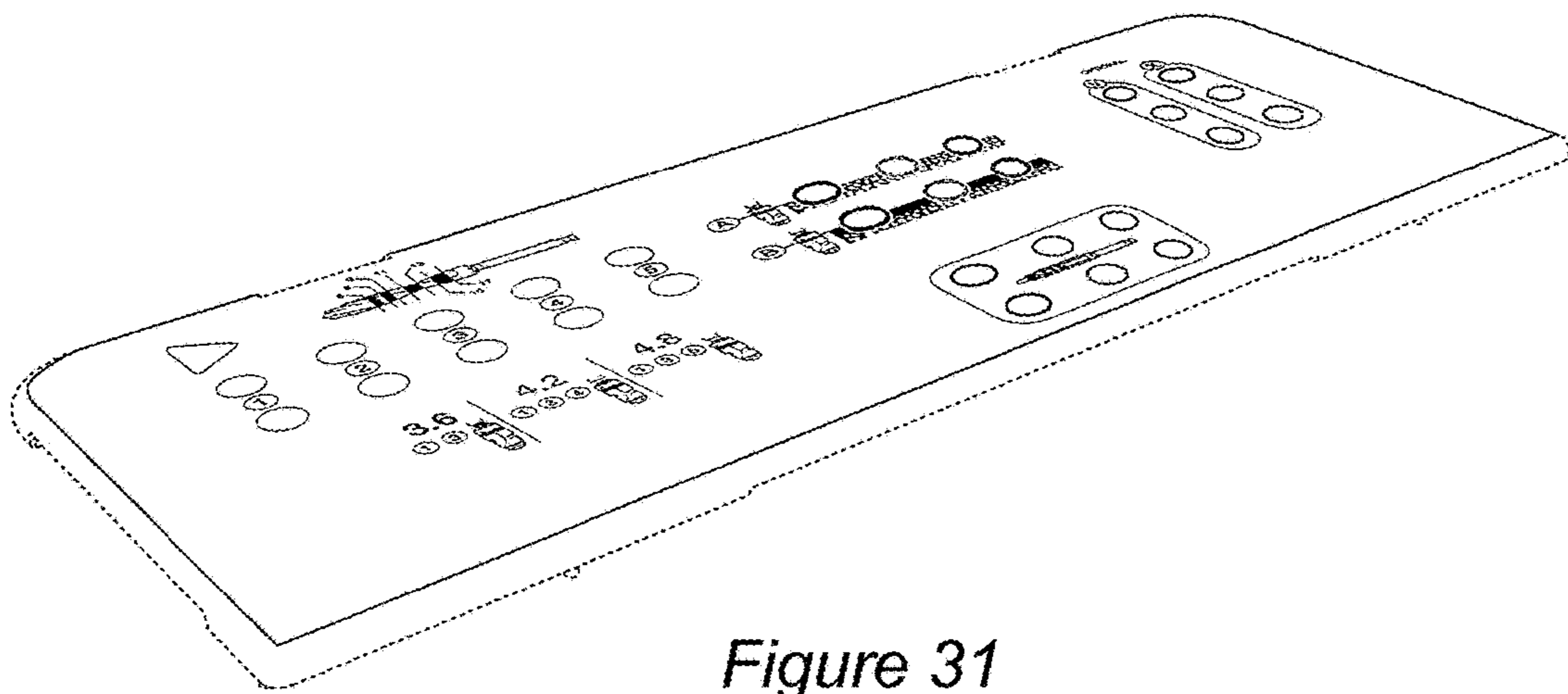

Figure 31

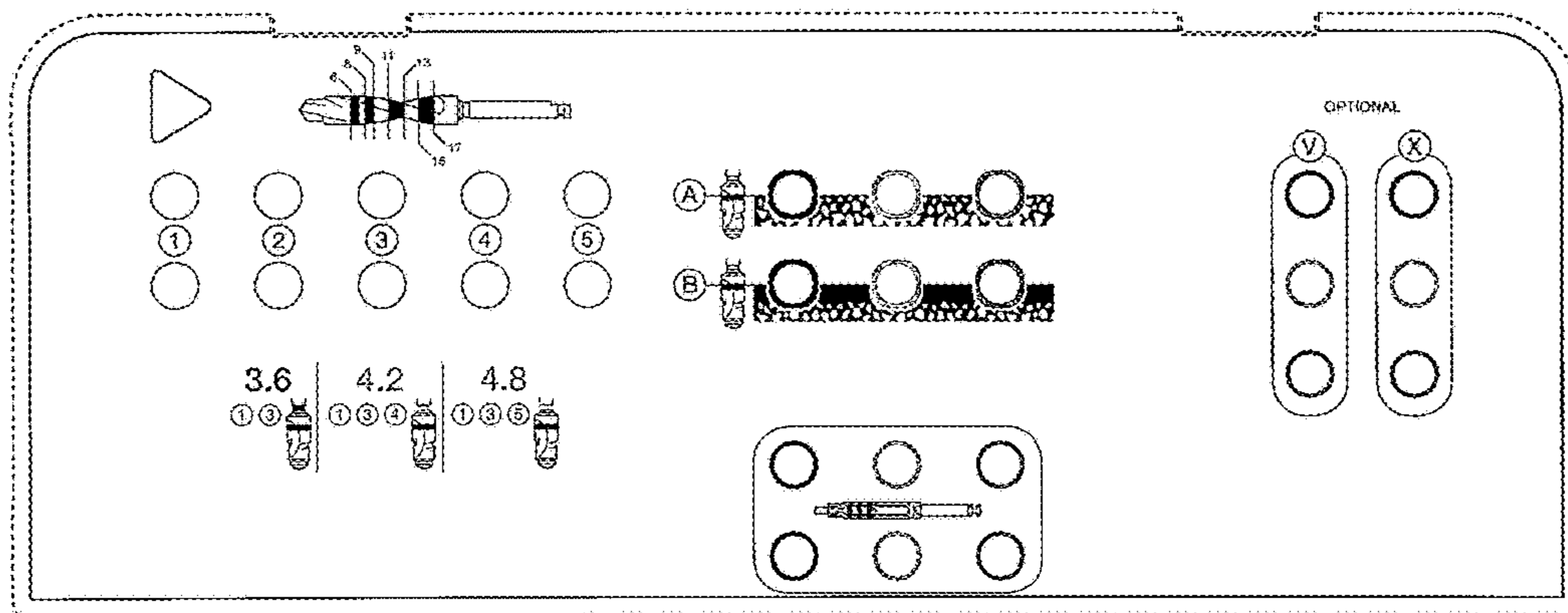

Figure 32

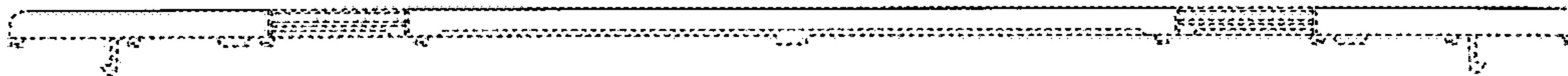

Figure 33

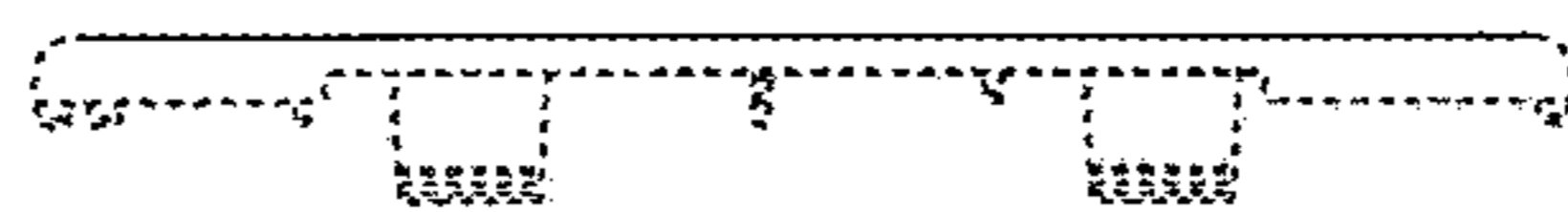

Figure 34

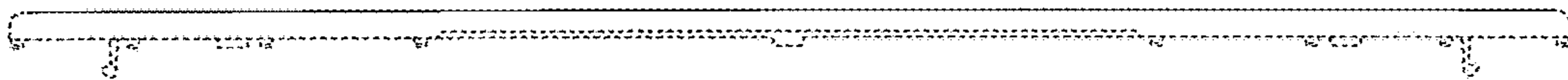

Figure 35

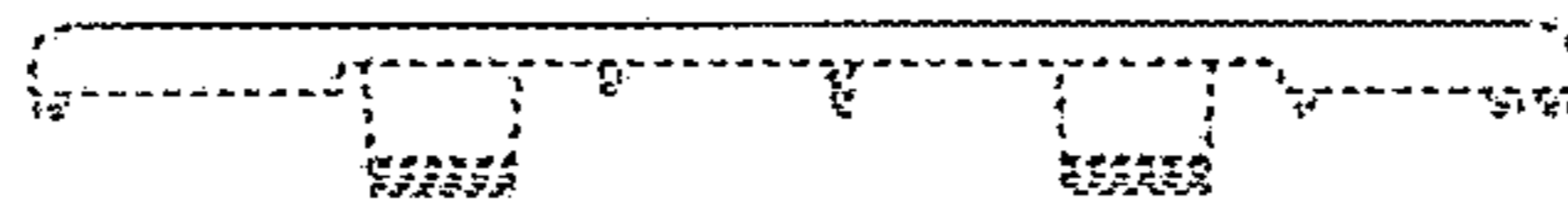

Figure 36

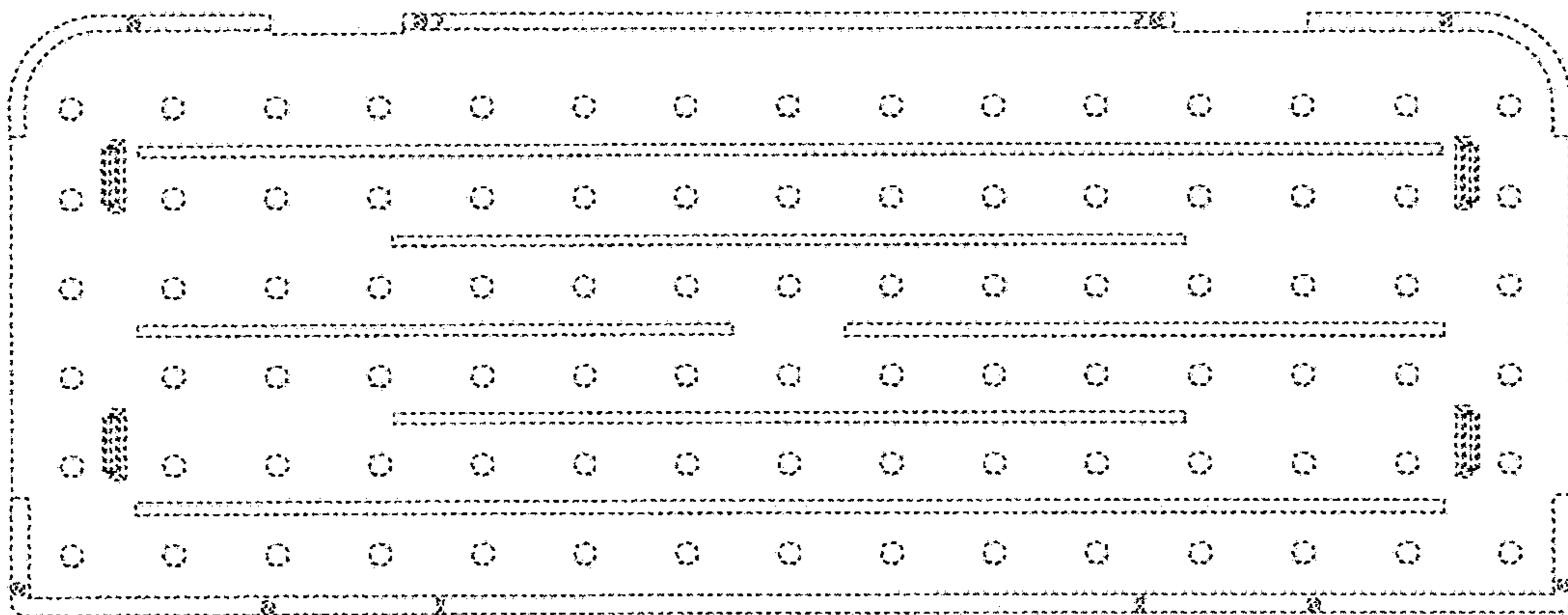

Figure 37

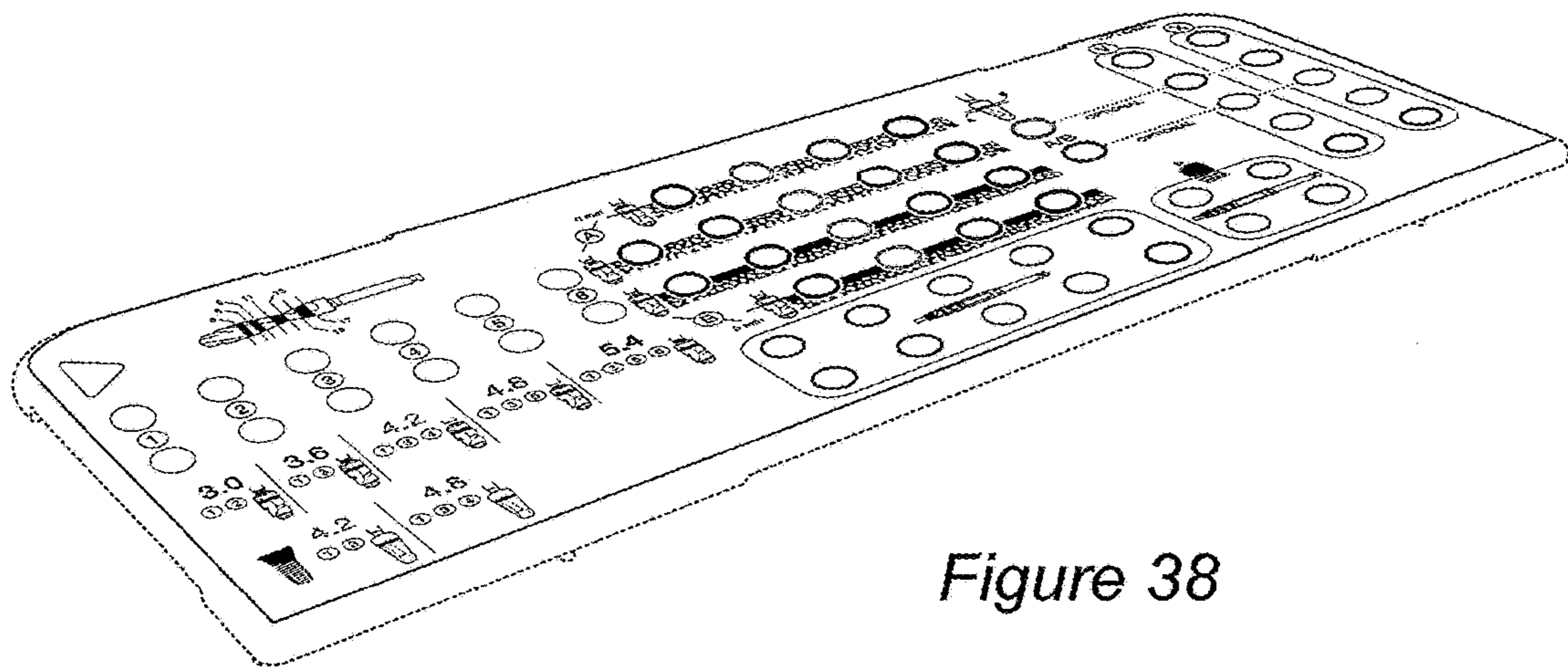

Figure 38

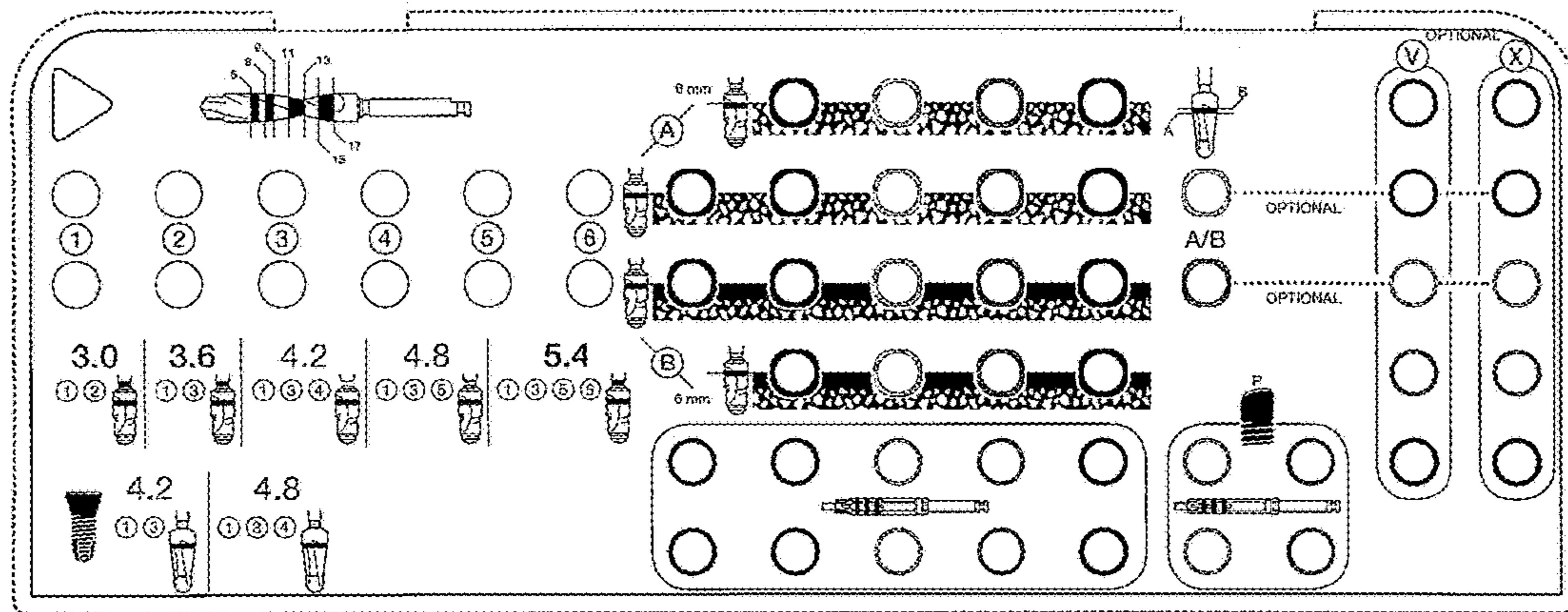

Figure 39

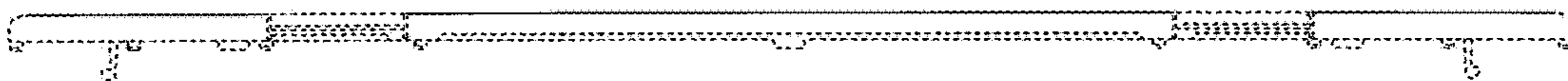

Figure 40

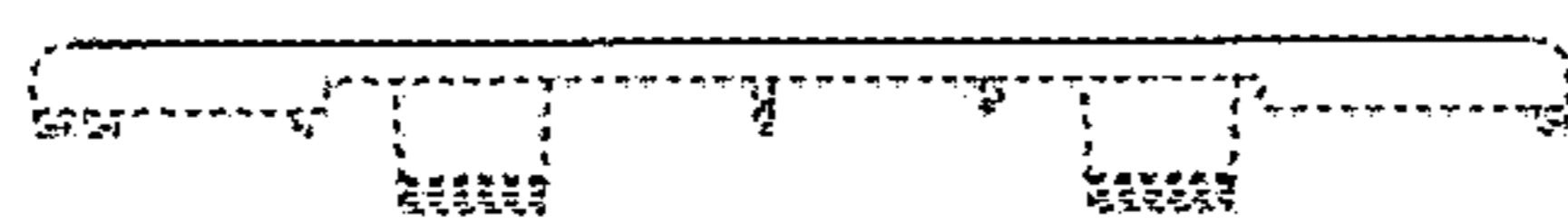

Figure 41

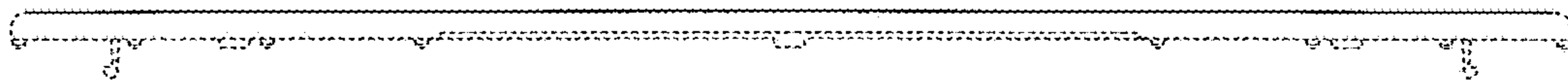

Figure 42

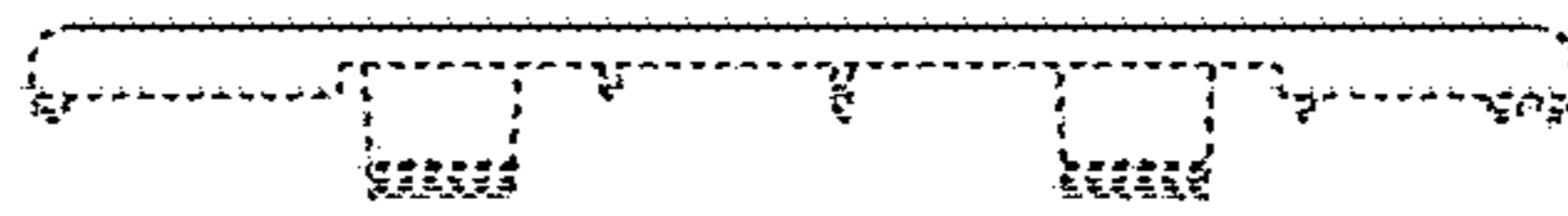

Figure 43

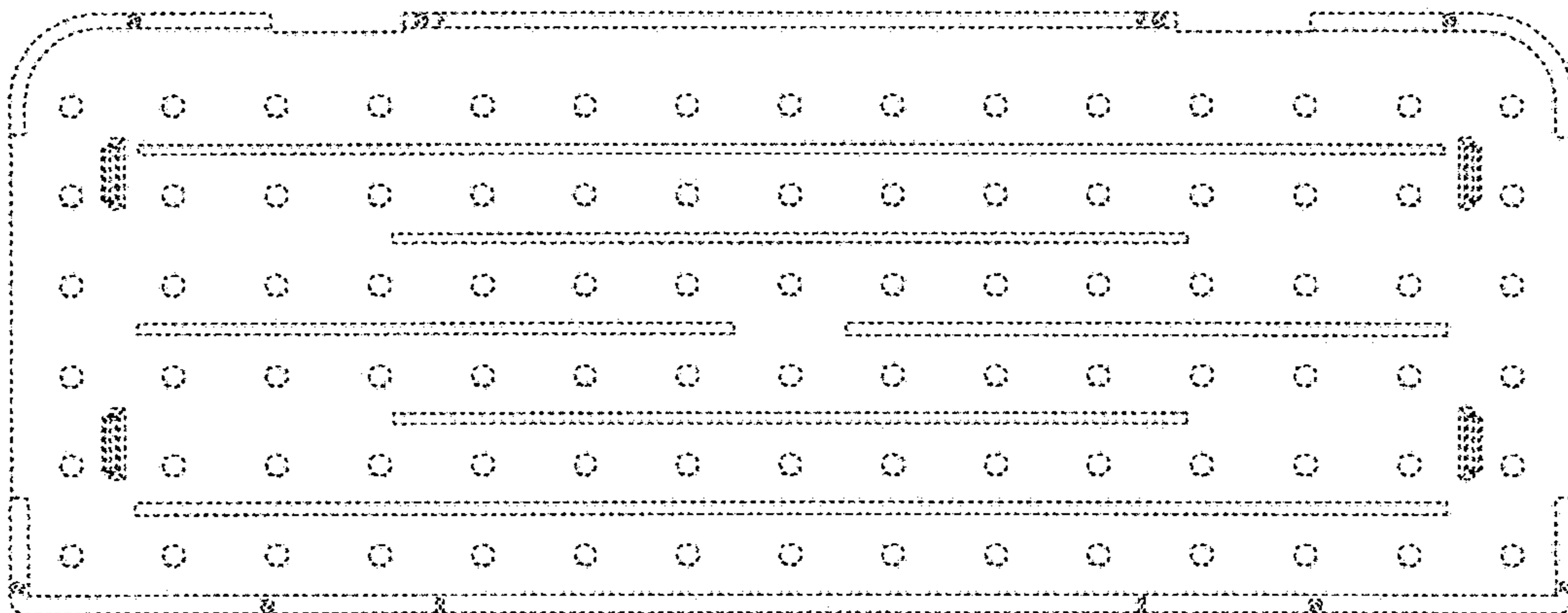

Figure 44

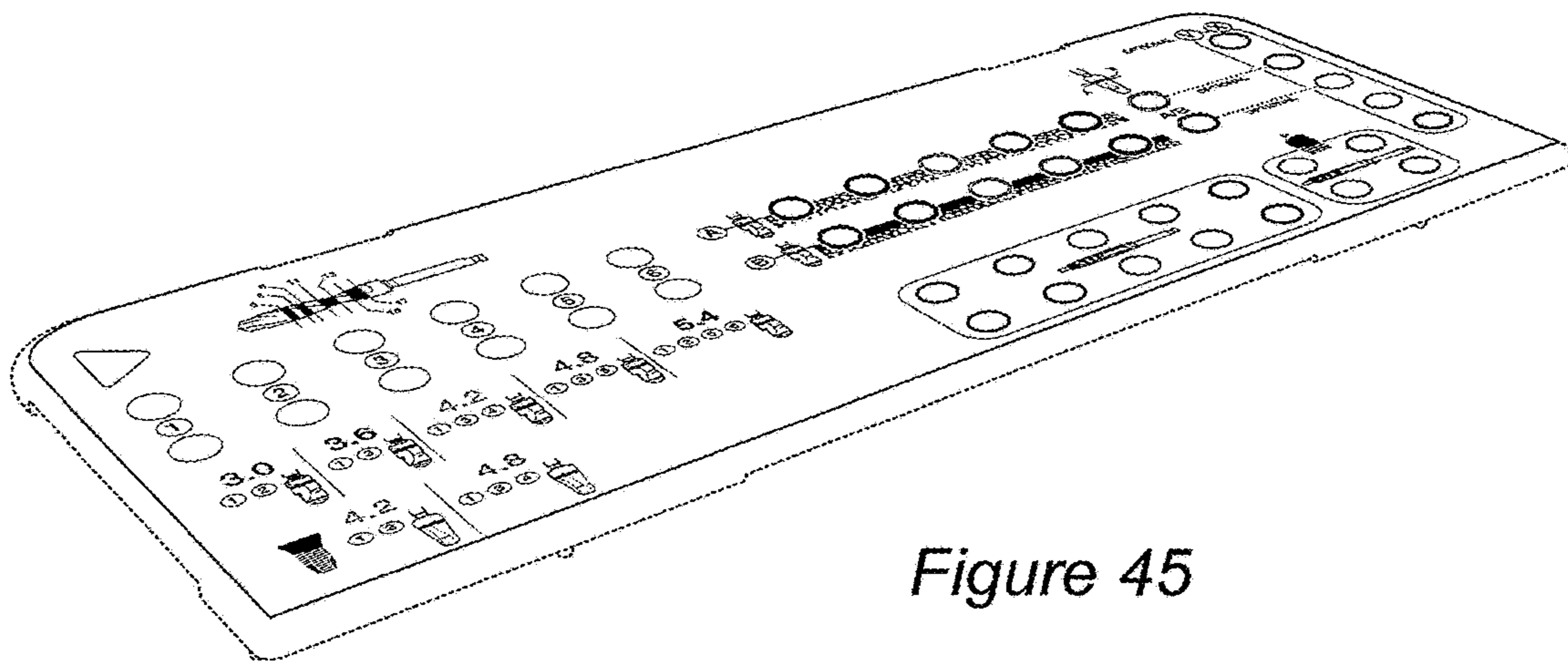

Figure 45

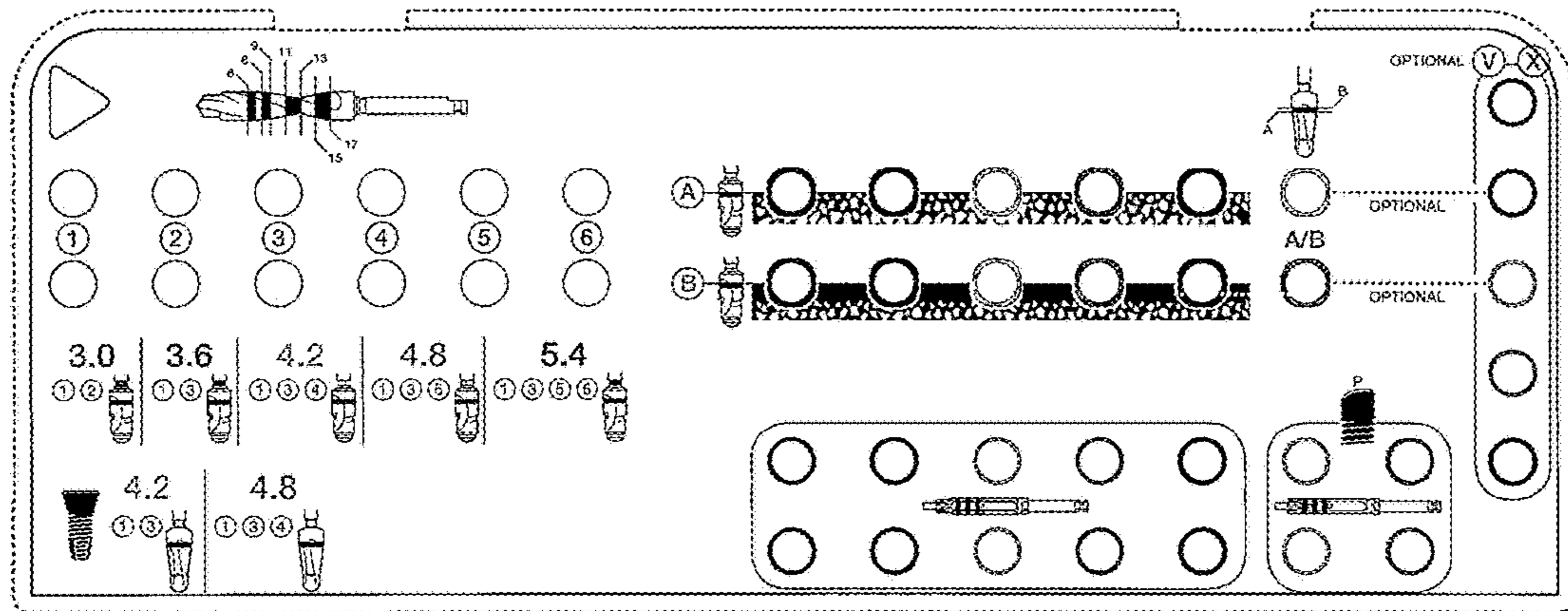

Figure 46

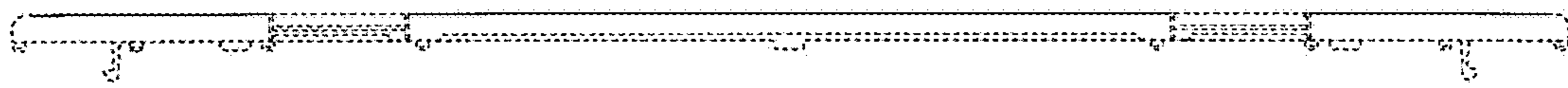

Figure 47

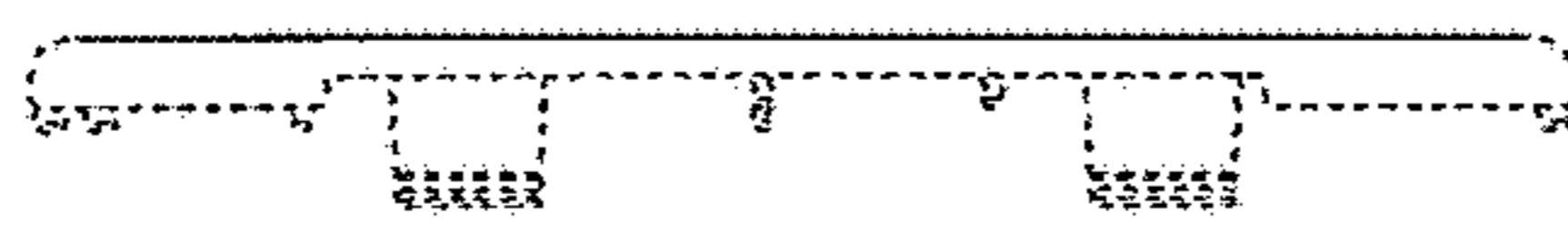

Figure 48

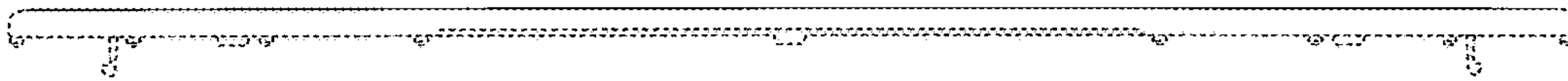

Figure 49

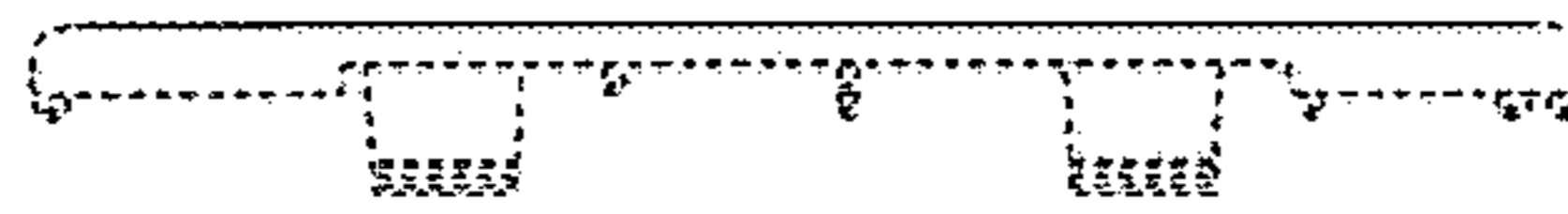

Figure 50

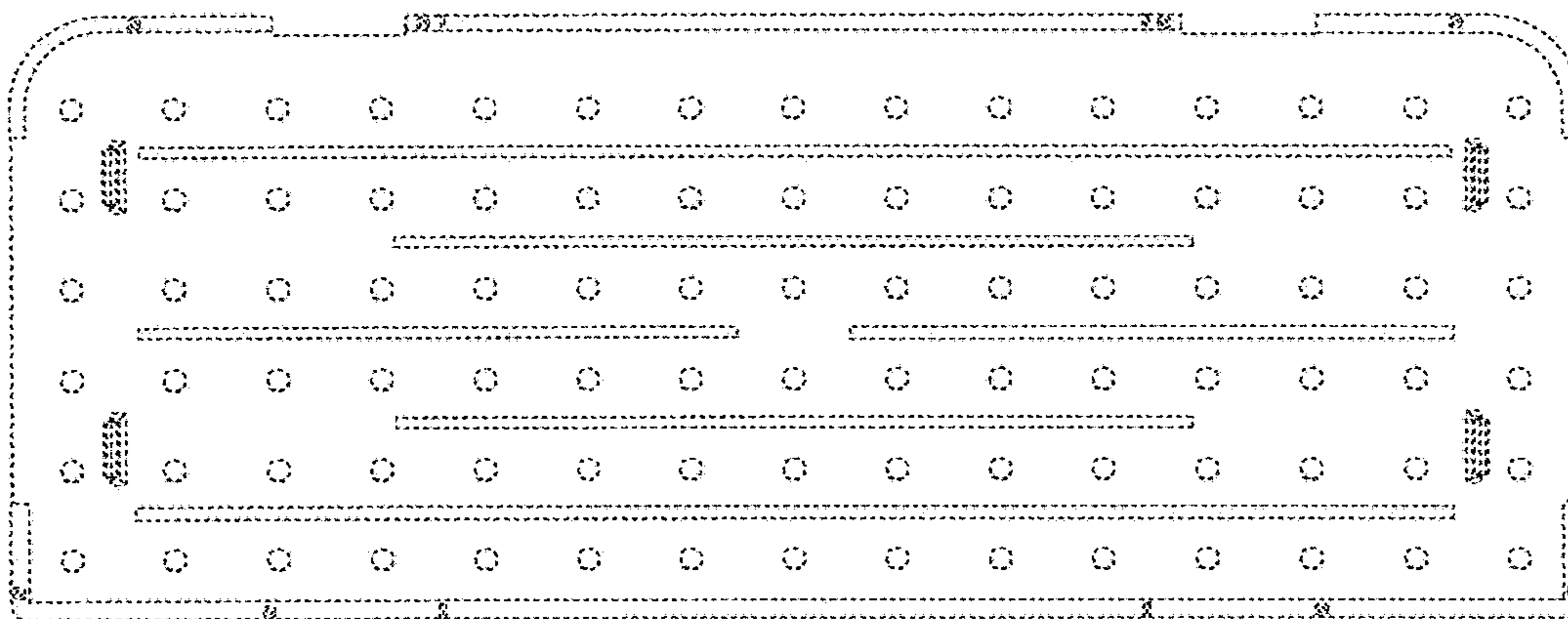

Figure 51

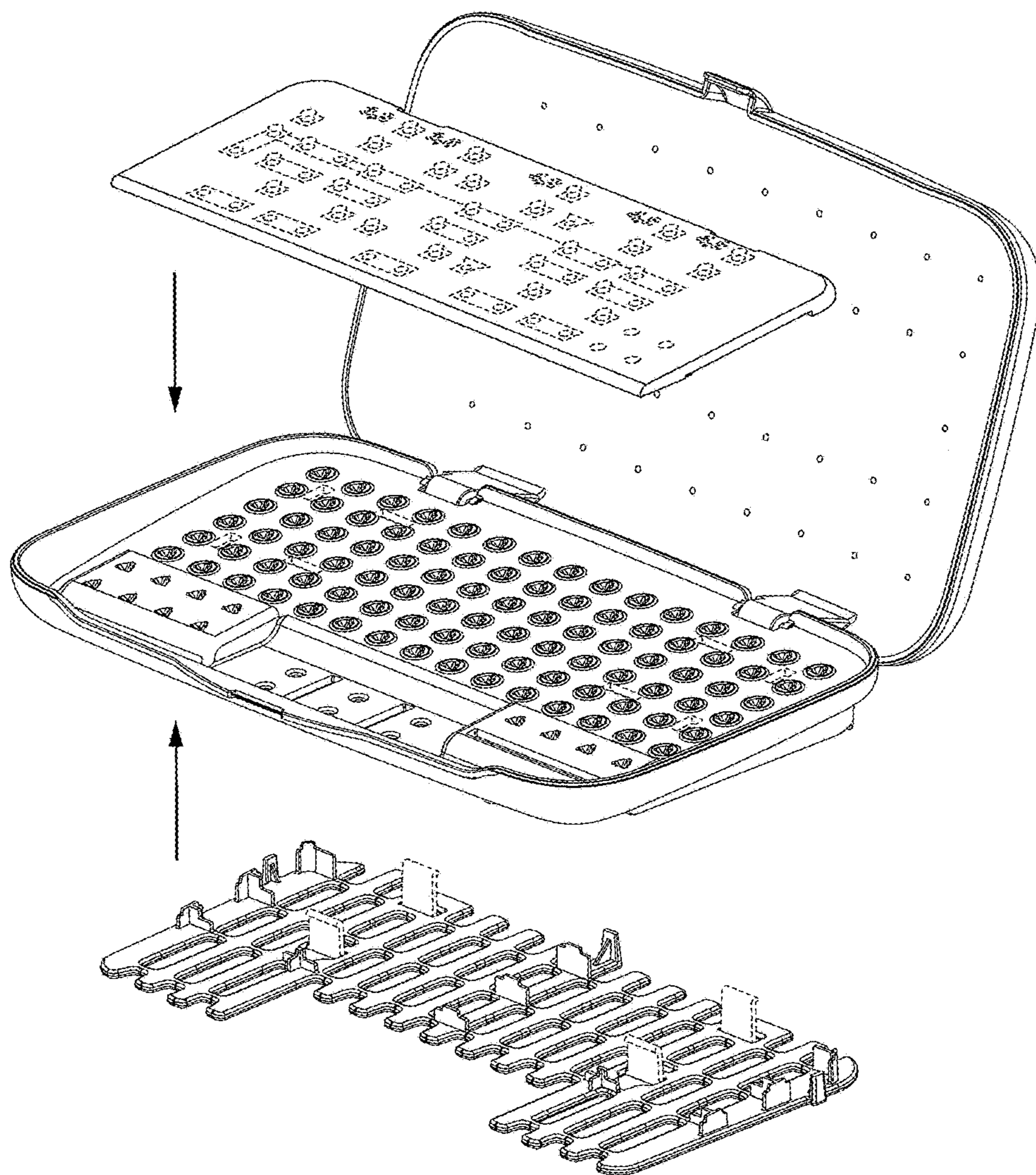

Figure 52