



US00D801268S

(12) **United States Design Patent** (10) **Patent No.:** **US D801,268 S**
Sid (45) **Date of Patent:** **** Oct. 31, 2017**

(54) **ROGOWSKI COIL**
(71) Applicant: **LEM INTELLECTUAL PROPERTY SA, Fribourg (CH)**
(72) Inventor: **Salim Sid, Annemasse (FR)**
(**) Term: **15 Years**
(21) Appl. No.: **35/501,128**

D649,115 S * 11/2011 Miura D13/117
D650,906 S * 12/2011 Phillips D24/158
D686,156 S * 7/2013 Ye D13/110
D693,301 S * 11/2013 Laurino D13/117
D706,714 S * 6/2014 Laurino D13/117
D721,651 S * 1/2015 Iwakura D13/117
D769,817 S * 10/2016 Sid D13/110
D779,429 S * 2/2017 Yamada D13/117
D779,430 S * 2/2017 Hayashizaka D13/117
D788,017 S * 5/2017 Smallhorn D12/345
2017/0010310 A1 * 1/2017 Morel G01R 1/04

(22) Filed: **Dec. 22, 2015**

* cited by examiner

(80) **Hague Agreement Data**

Primary Examiner — Rhea Shields

Int. Filing Date: **Dec. 22, 2015**
Int. Reg. No.: **DM/089118**
Int. Reg. Date: **Dec. 22, 2015**
Int. Reg. Pub. Date: **Jun. 24, 2016**

(57) **CLAIM**

The ornamental design for a Rogowski coil, as shown and described.

(51) **LOC (10) Cl.** **13-03**

(52) **U.S. Cl.**
USPC **D13/117**

(58) **Field of Classification Search**
USPC D13/117, 122, 152, 153, 110; D12/345; D24/158; 174/50
CPC B23P 19/068; G01R 1/04
See application file for complete search history.

DESCRIPTION

1. Rogowski coil
1.1: is a top, front, left side Perspective view of a Rogowski coil showing my new design;
1.2: is a bottom, front, left side Perspective view thereof;
1.3 is a top, rear, right side Perspective view thereof;
1.4 is a Front elevation view thereof;
1.5 is a Back elevation view thereof;
1.6 is a Top plan view thereof;
1.7 is a Bottom plan view thereof;
1.8 is a Left side view thereof; and
1.9 is a Right side view thereof.
In views **1.1** to **1.8** one cable end is not represented in its entirety.

(56) **References Cited**

U.S. PATENT DOCUMENTS

7,705,272 B2 * 4/2010 Kelly B23P 19/068 174/50
D640,198 S * 6/2011 Wu D13/122

1 Claim, 9 Drawing Sheets

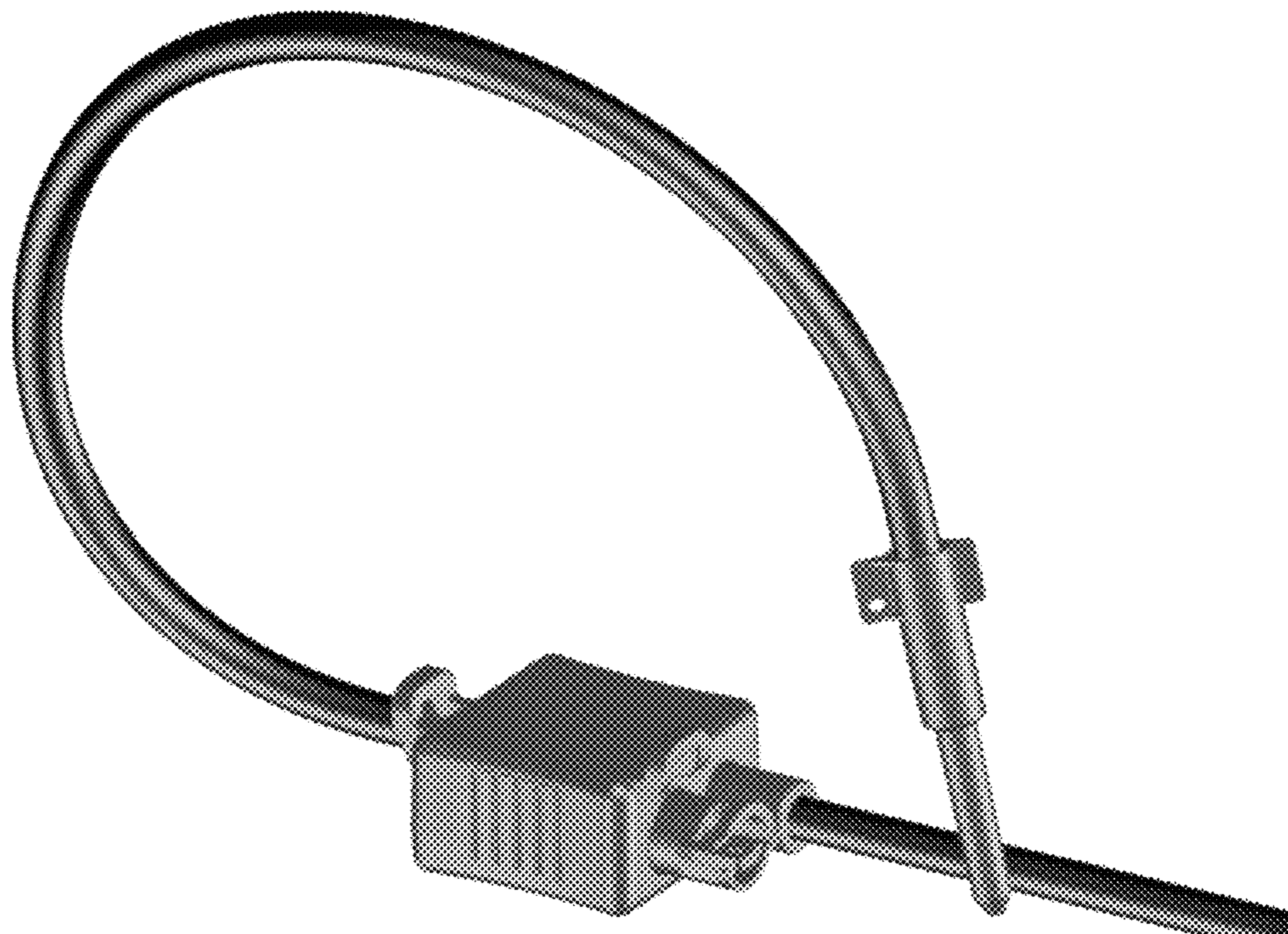

1.1

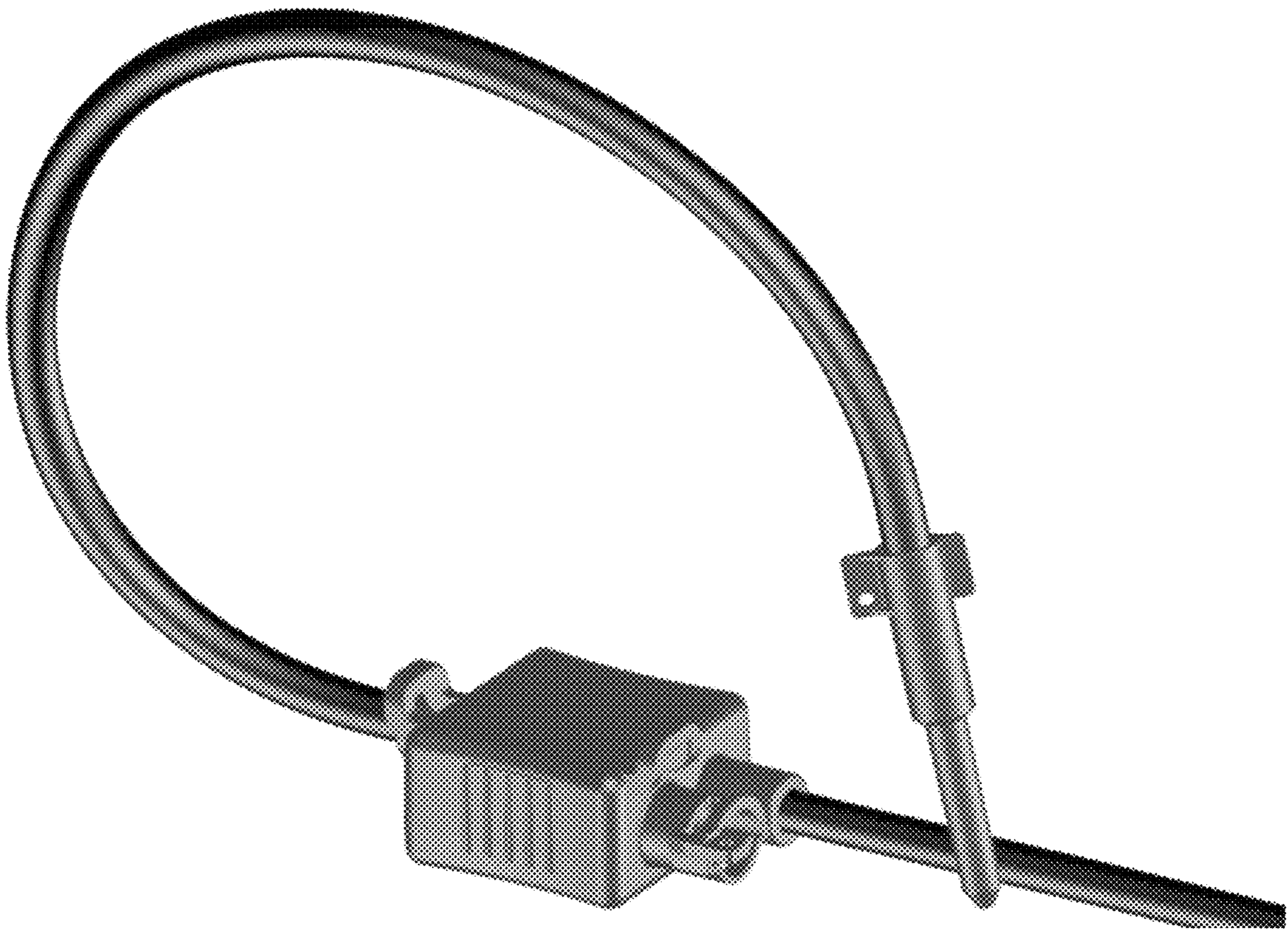

1.2

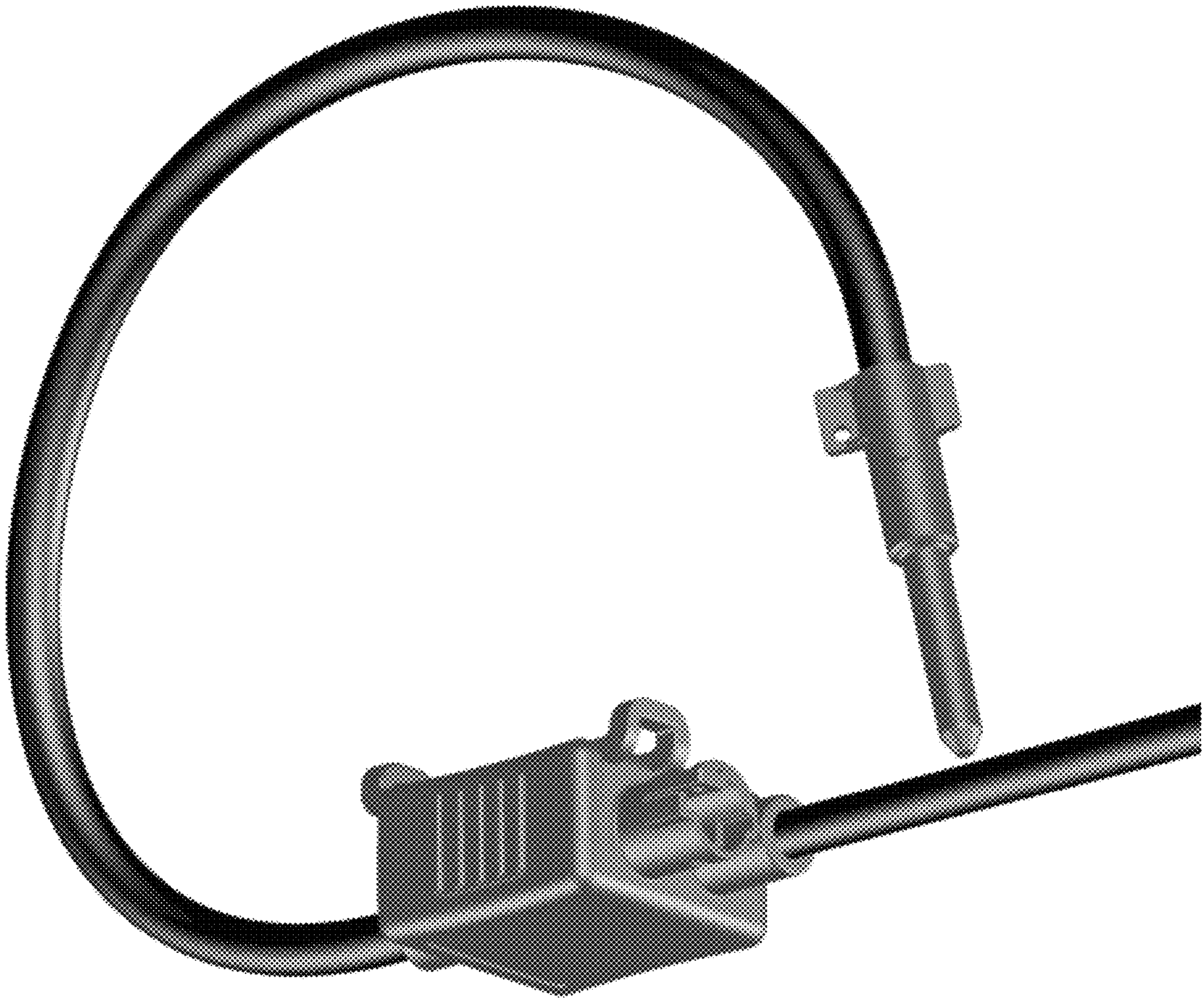

1.3



1.4

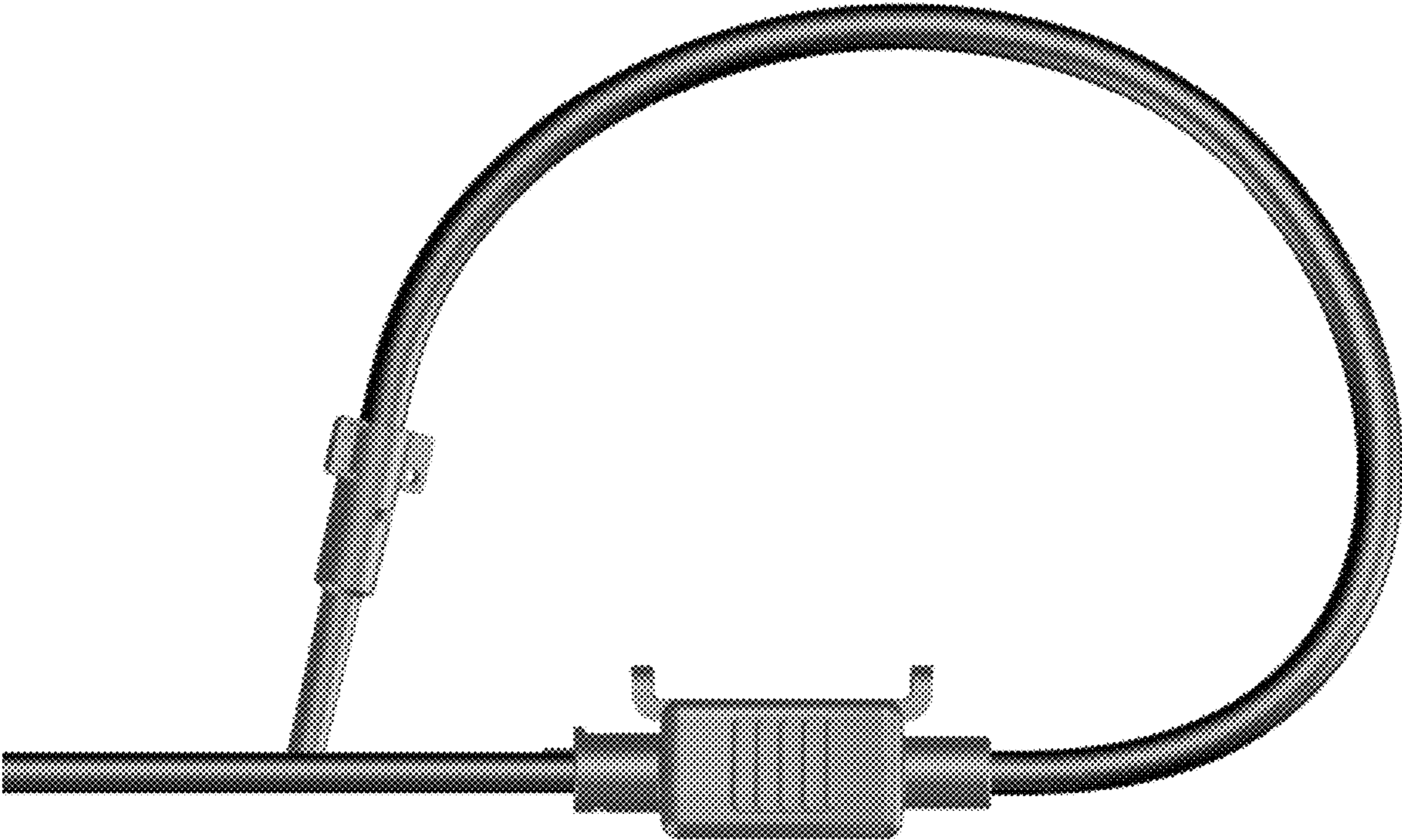

1.5

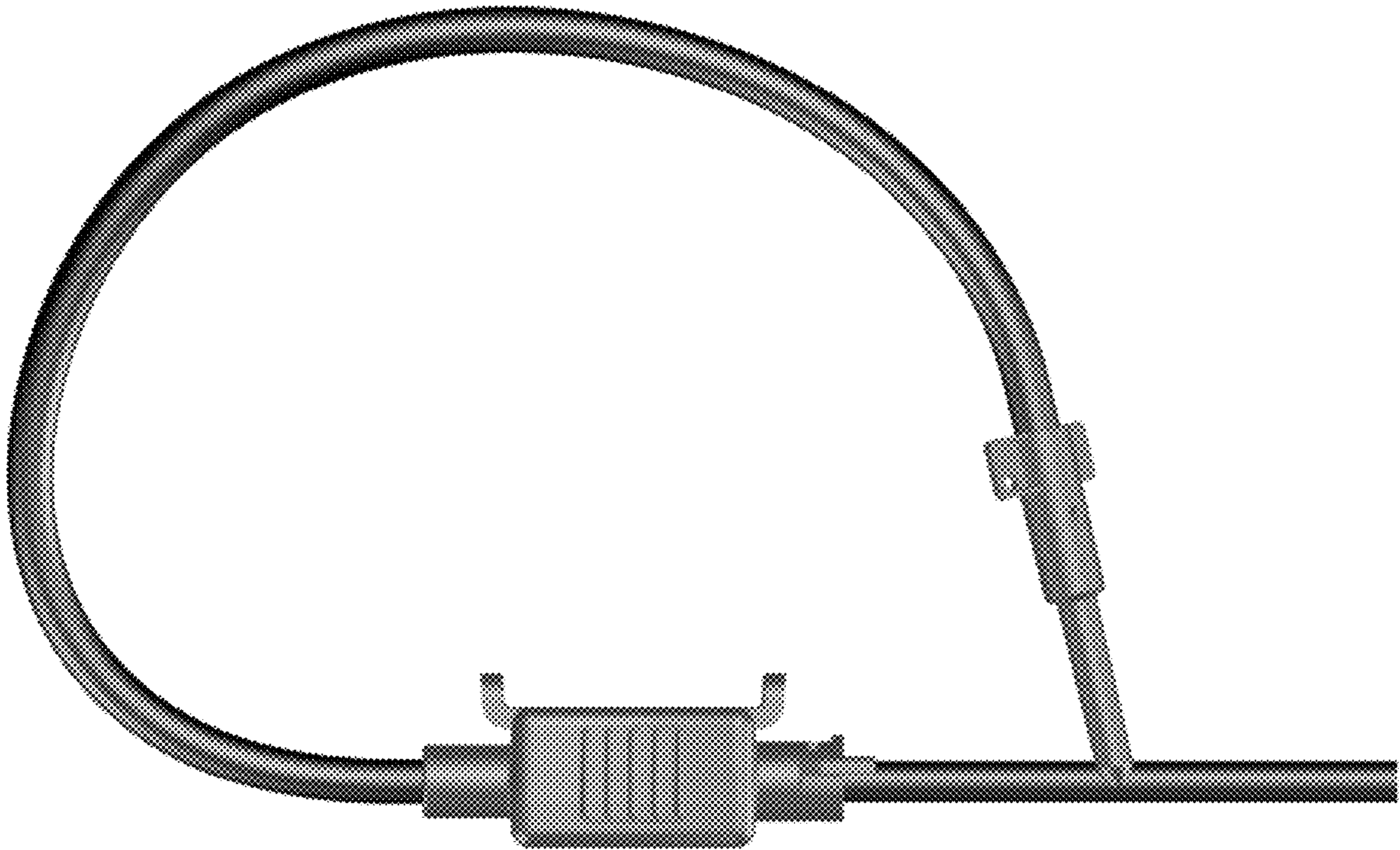

1.6

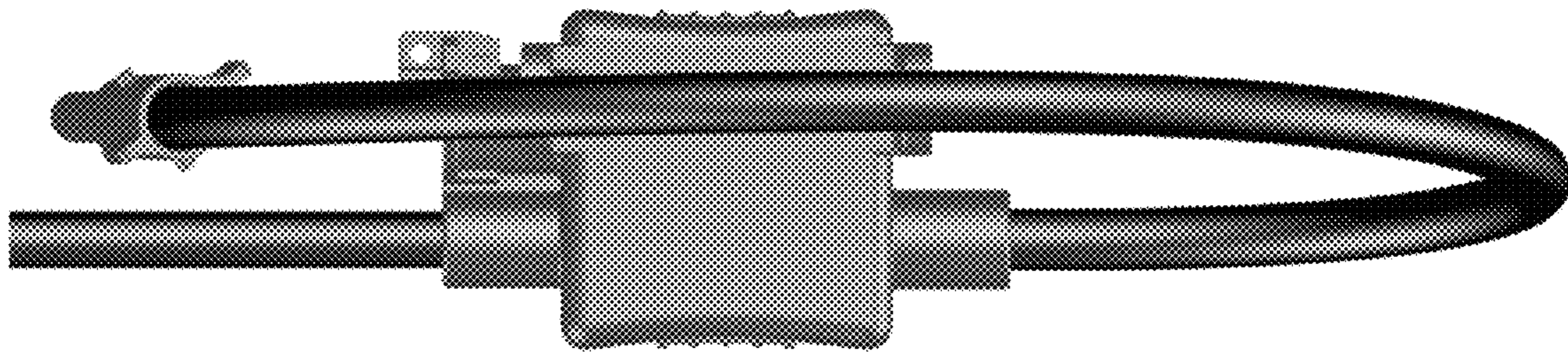

1.7

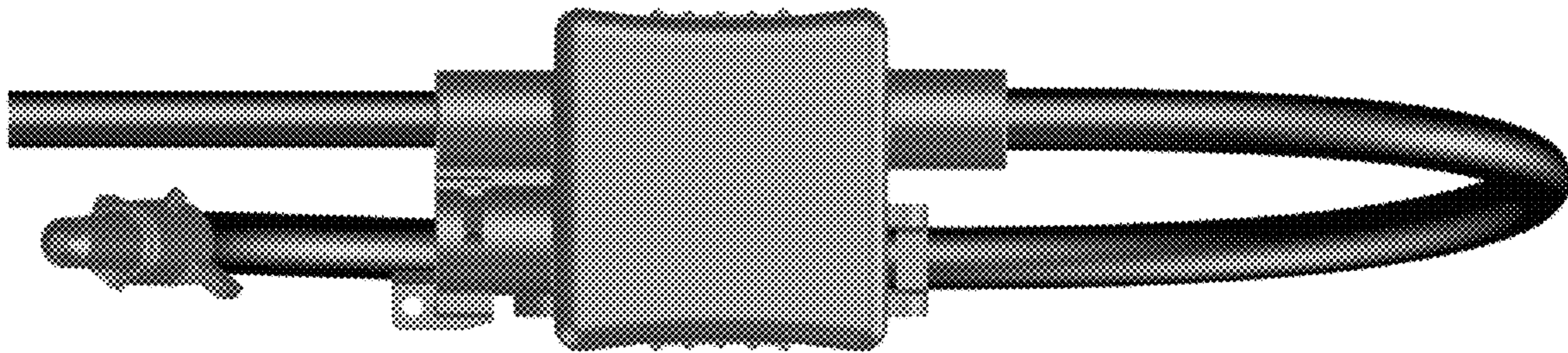

1.8

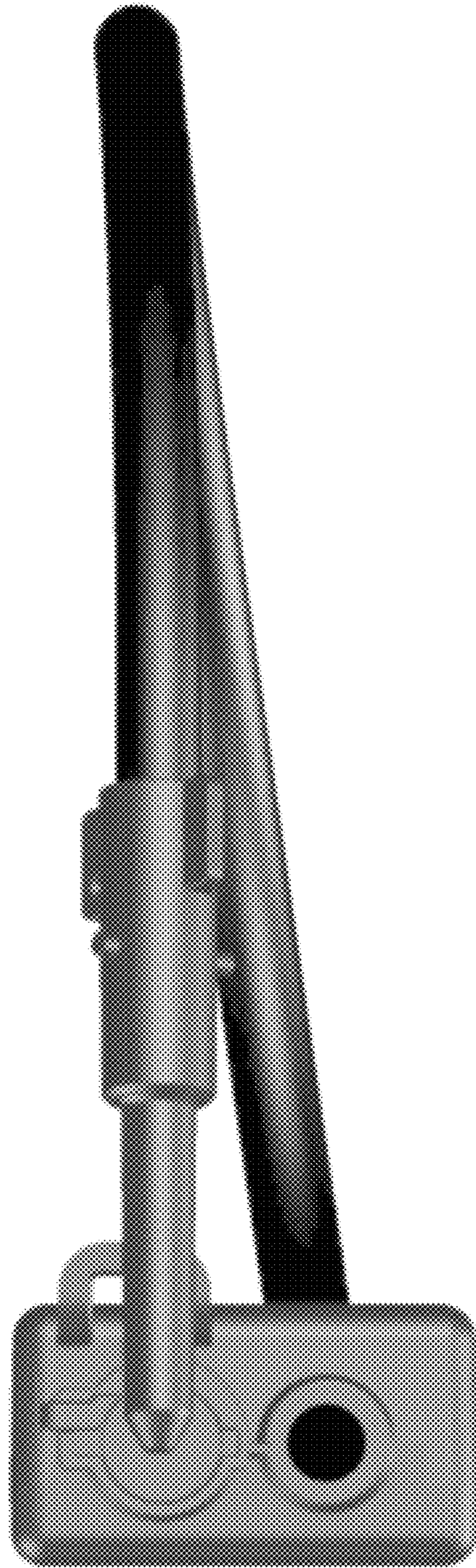

1.9

