



US00D801265S

(12) **United States Design Patent** (10) **Patent No.:** **US D801,265 S**  
**Dahari** (45) **Date of Patent:** **\*\* Oct. 31, 2017**

(54) **SOLAR PLATE**

(71) Applicant: **Mahidzal Bin Dahari**, Kuala Lumpur (MY)

(72) Inventor: **Mahidzal Bin Dahari**, Kuala Lumpur (MY)

(73) Assignee: **UNIVERSITI MALAYA**, Kuala Lumpur (MY)

(\*\*) Term: **15 Years**

(21) Appl. No.: **29/527,999**

(22) Filed: **May 23, 2015**

**Related U.S. Application Data**

(63) Continuation-in-part of application No. 29/467,627, filed on Sep. 20, 2013, now abandoned.

**Foreign Application Priority Data**

Mar. 22, 2013 (MY) ..... 13-00354-0101

(51) **LOC (10) Cl.** ..... **13-02**

(52) **U.S. Cl.**  
USPC ..... **D13/102**

(58) **Field of Classification Search**

USPC ..... D13/102, 101, 103, 107, 108, 184, 199;  
D6/406.1, 406.5, 406.6, 691; 108/25, 26,  
108/115, 118, 119, 161; 136/206, 243,  
136/244, 245, 252; 320/101, 102, 114,  
320/115, 120

CPC ..... H01L 31/022433; H01L 31/0224; H01L  
31/0475; H01L 31/042; F24J 2/36; F24J  
2/523; F24J 2/5235; Y02E 10/50; H02J  
7/355

See application file for complete search history.

(56) **References Cited**

U.S. PATENT DOCUMENTS

3,646,895 A \* 3/1972 Campbell ..... A47B 3/02  
108/118  
D279,214 S \* 6/1985 Hanson ..... D13/102  
6,201,181 B1 \* 3/2001 Azzam ..... F24J 2/36  
126/600  
D505,113 S \* 5/2005 Lam ..... D13/107  
7,243,896 B2 \* 7/2007 Zhang ..... B25H 1/04  
248/164  
8,266,847 B2 \* 9/2012 Edgar ..... F24J 2/523  
136/244  
D668,884 S \* 10/2012 Olano Jauregui ..... D6/691.6  
D671,885 S \* 12/2012 Steinau ..... D13/102  
D697,864 S \* 1/2014 McGrath ..... D13/102  
8,661,748 B2 \* 3/2014 Lewenz ..... F24J 2/5235  
52/173.3  
D746,768 S \* 1/2016 Laitila ..... D13/102

\* cited by examiner

*Primary Examiner* — Derrick Holland

(74) *Attorney, Agent, or Firm* — Preston Smirman;  
Smirman IP Law, PLLC

(57) **CLAIM**

I claim the ornamental design for a solar plate, as shown and described.

**DESCRIPTION**

FIG. 1 is top perspective view of a solar plate showing my new design;

FIG. 2 is a top plan view thereof;

FIG. 3 is a left side view thereof;

FIG. 4 is a right side view thereof;

FIG. 5 is a front view thereof;

FIG. 6 is a rear view thereof; and,

FIG. 7 is a bottom plan view thereof.

**1 Claim, 7 Drawing Sheets**

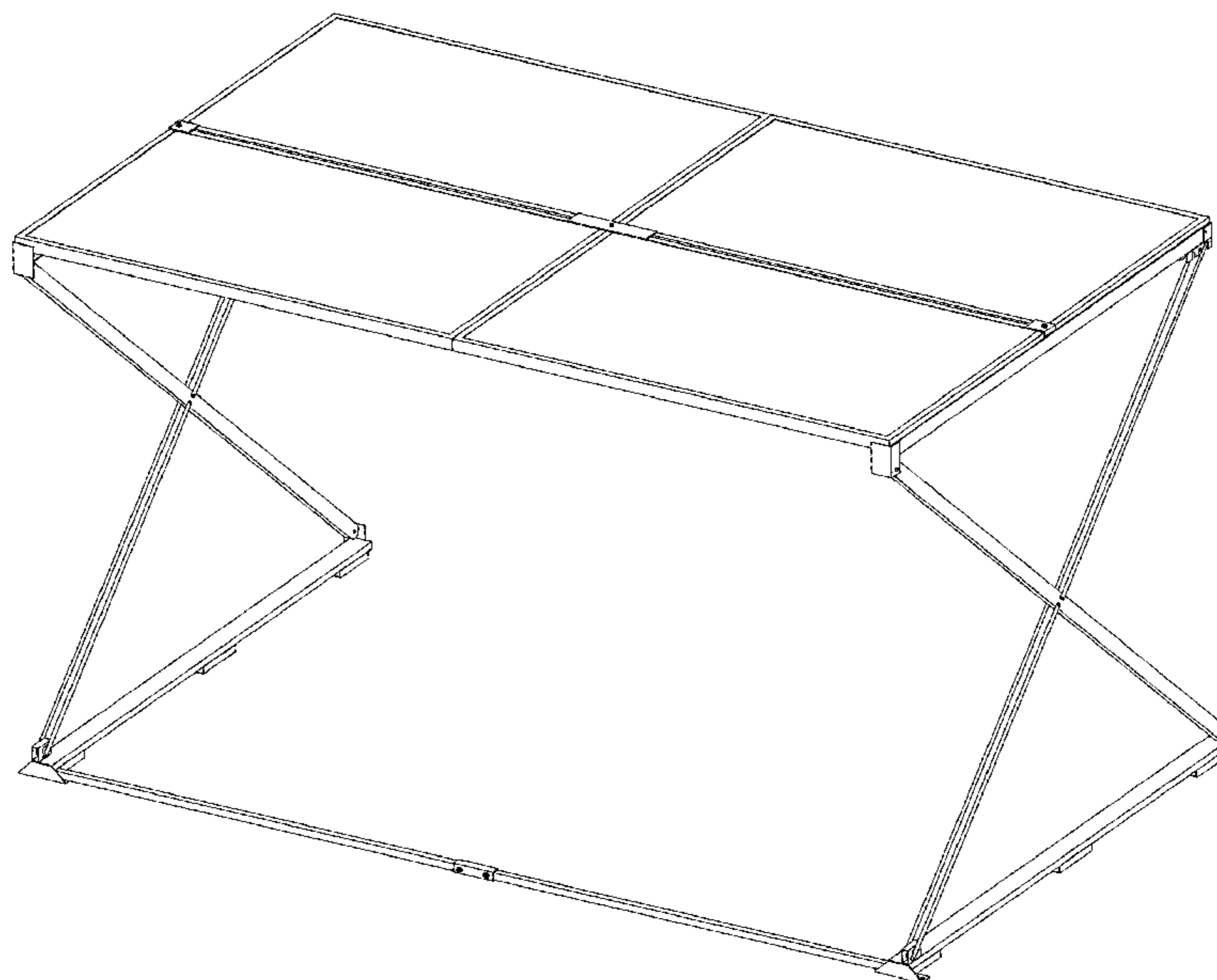

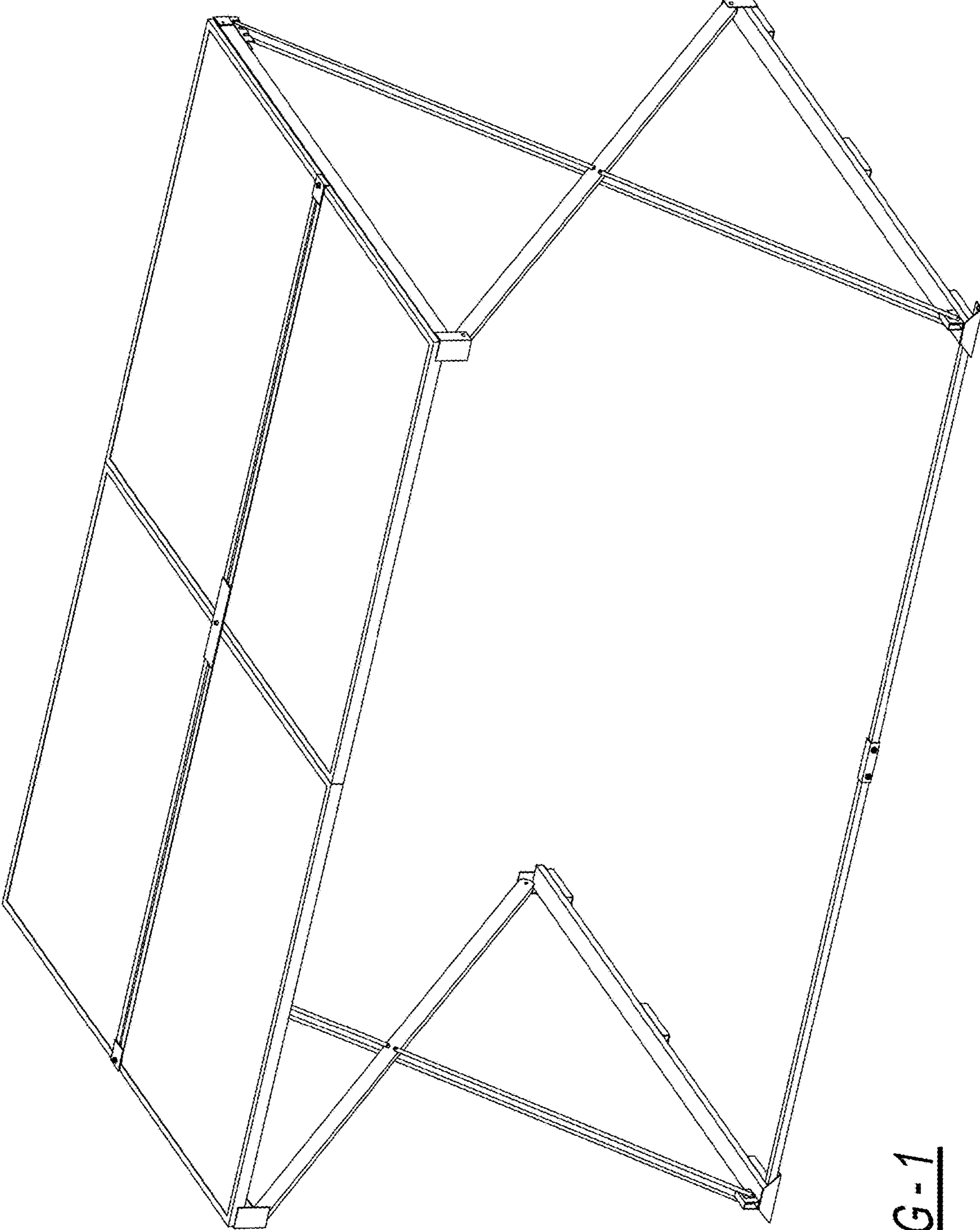

FIG - 1

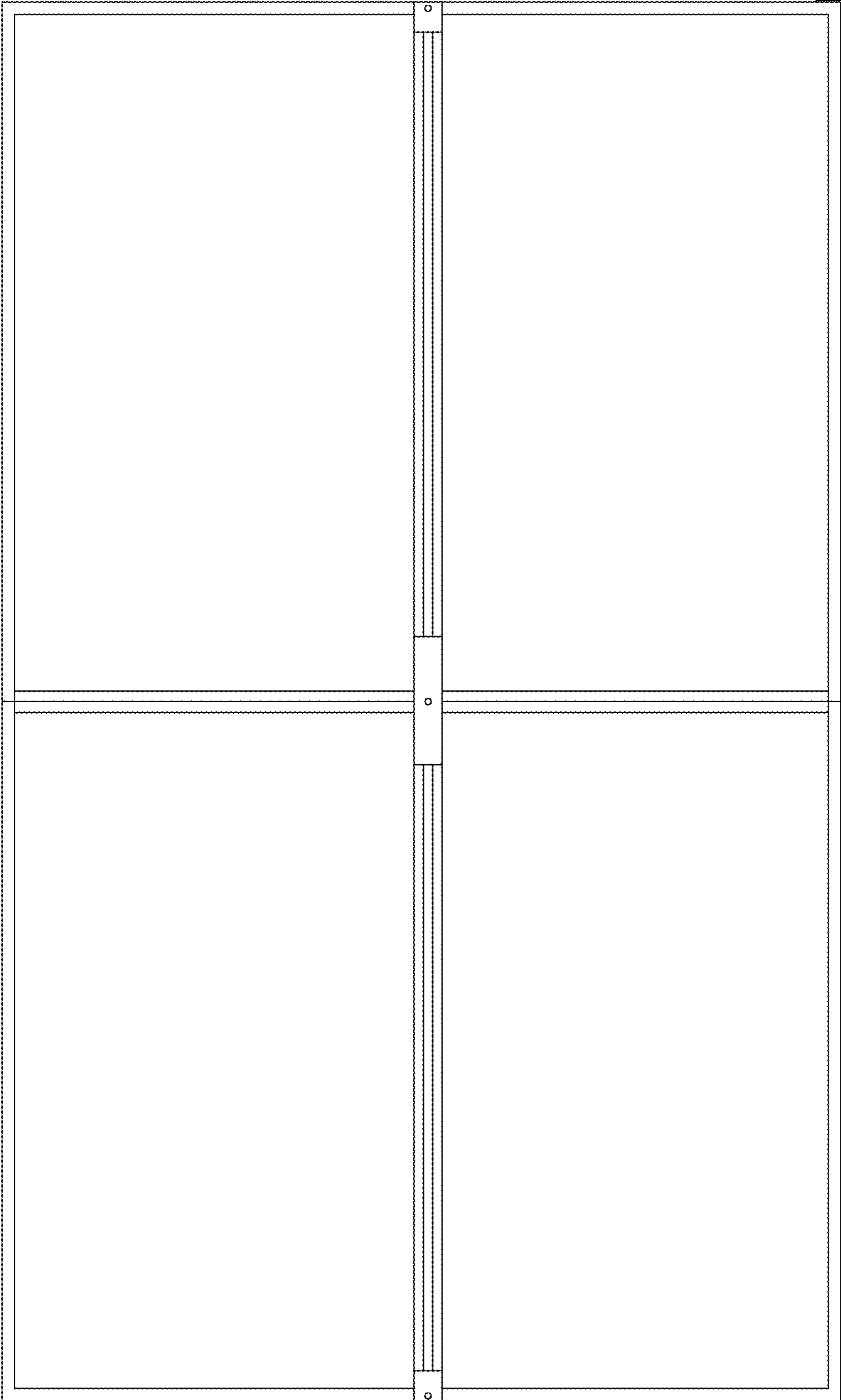

FIG-2

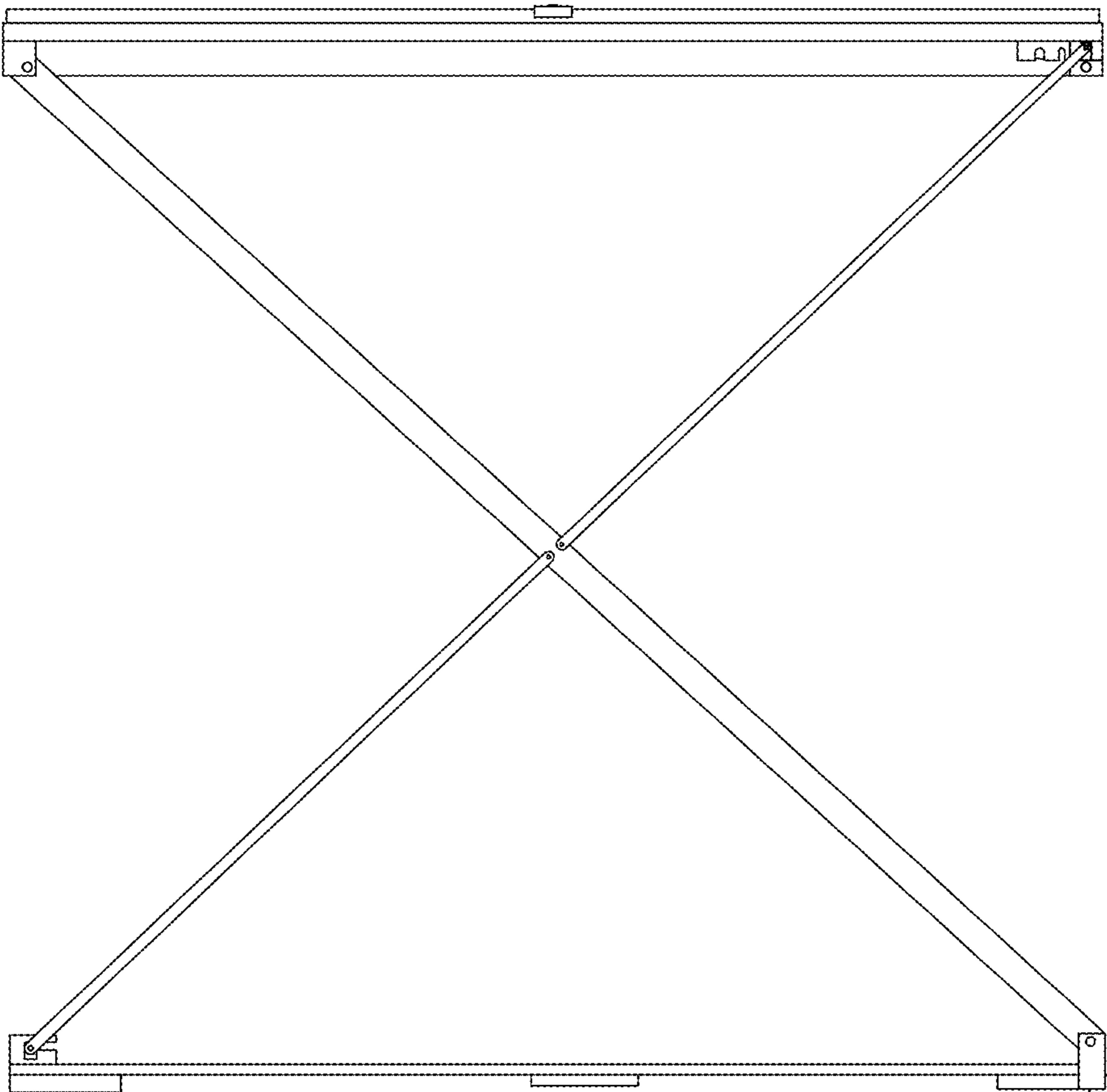

FIG - 3

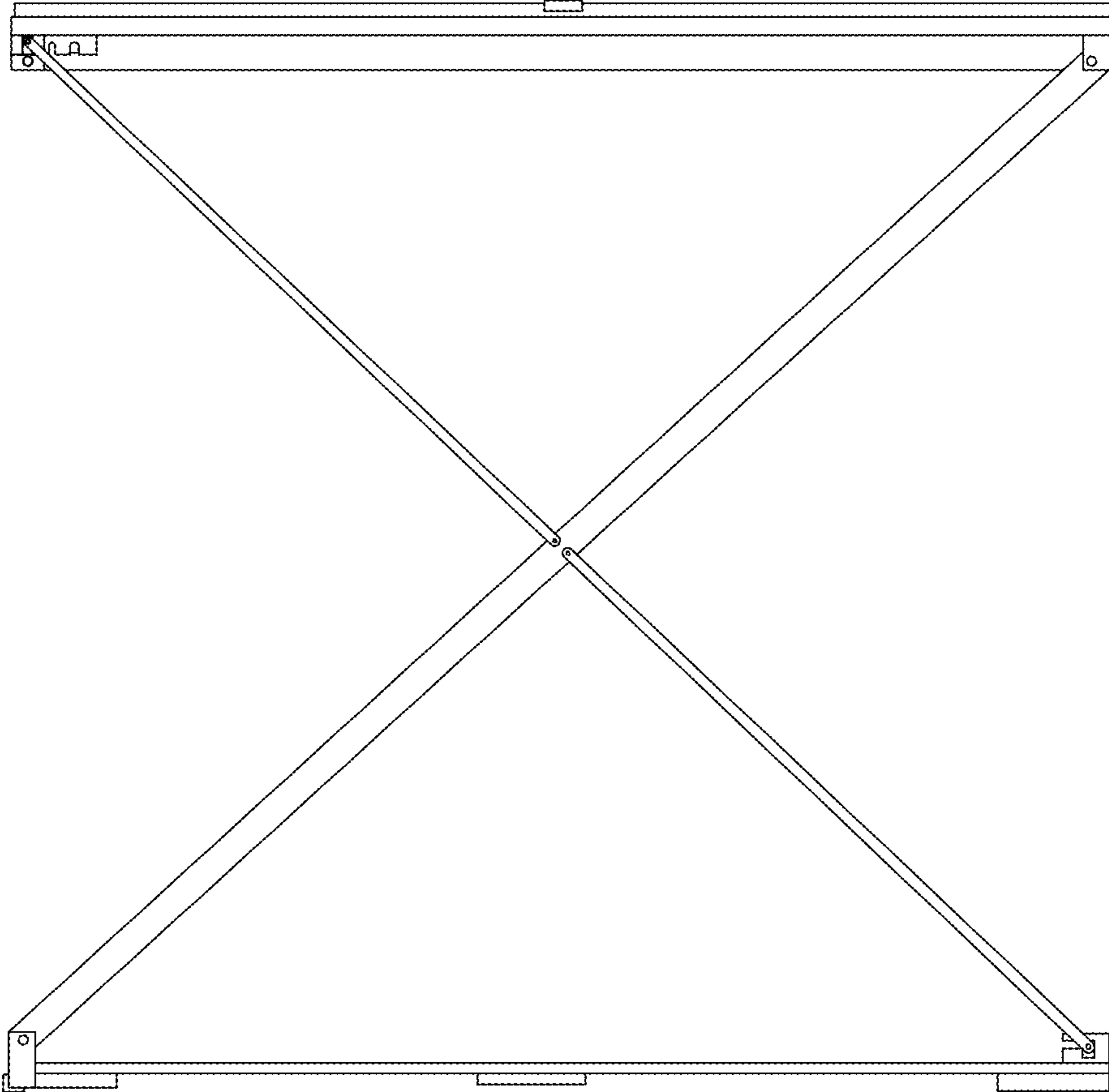

FIG - 4

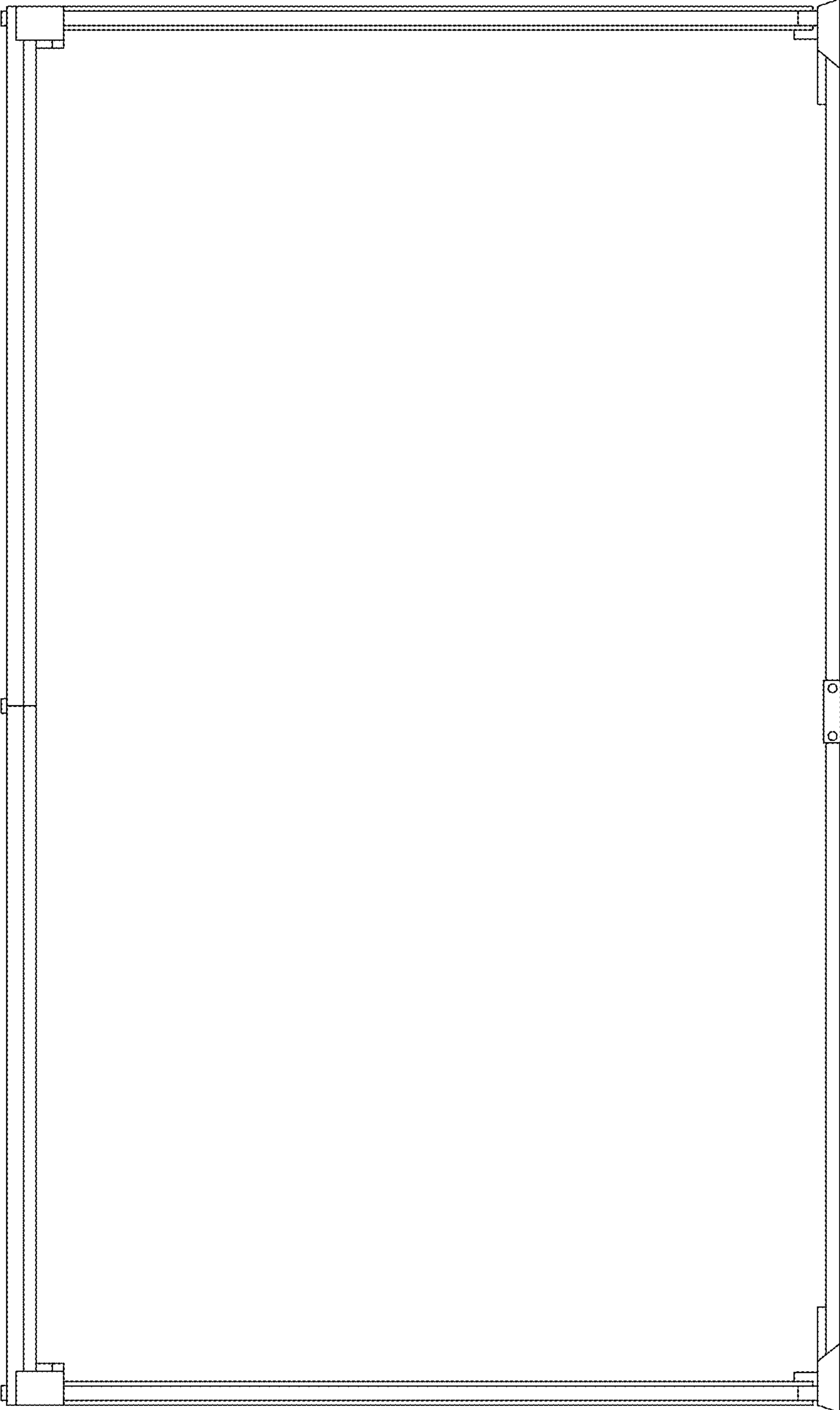

FIG - 5

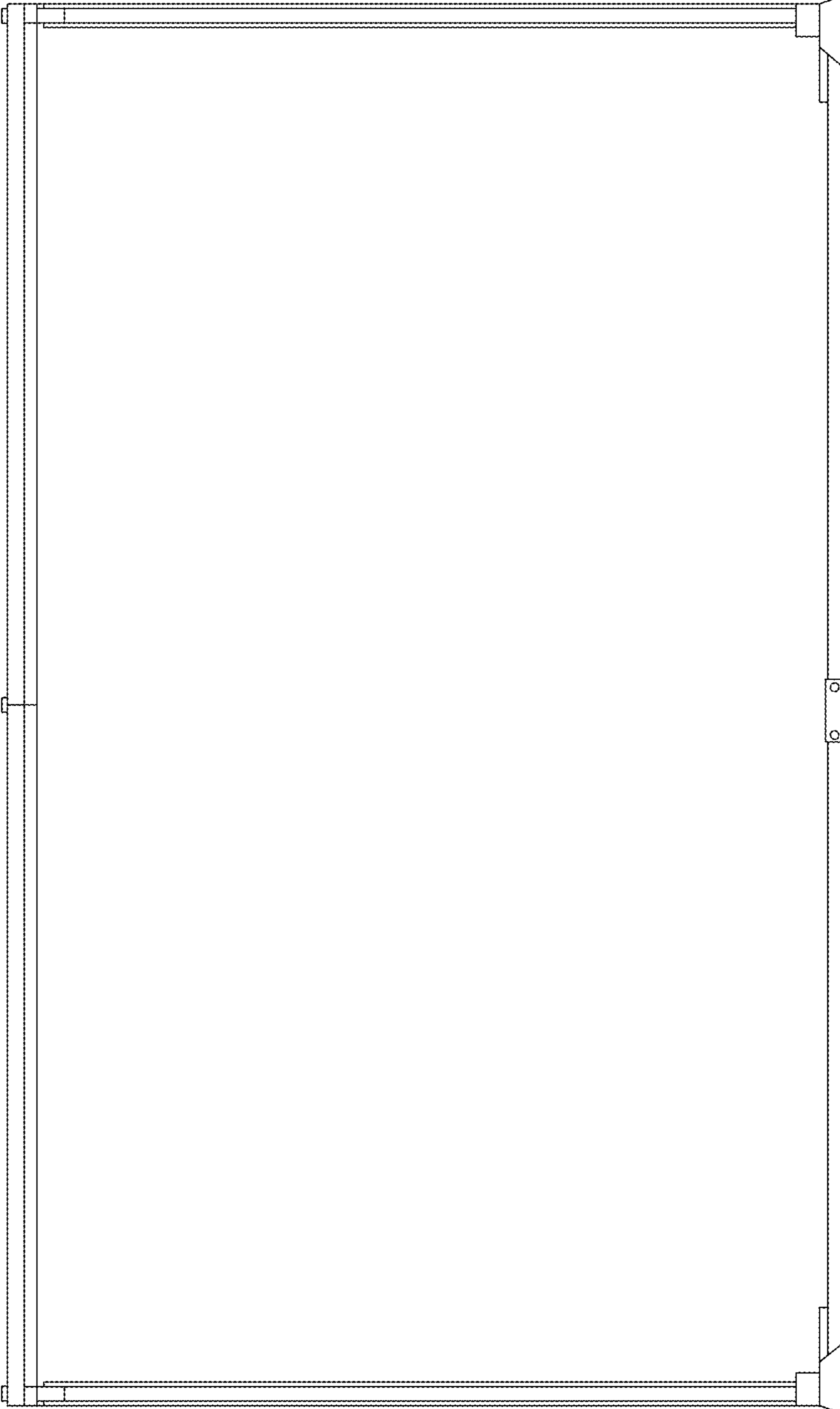

FIG - 6

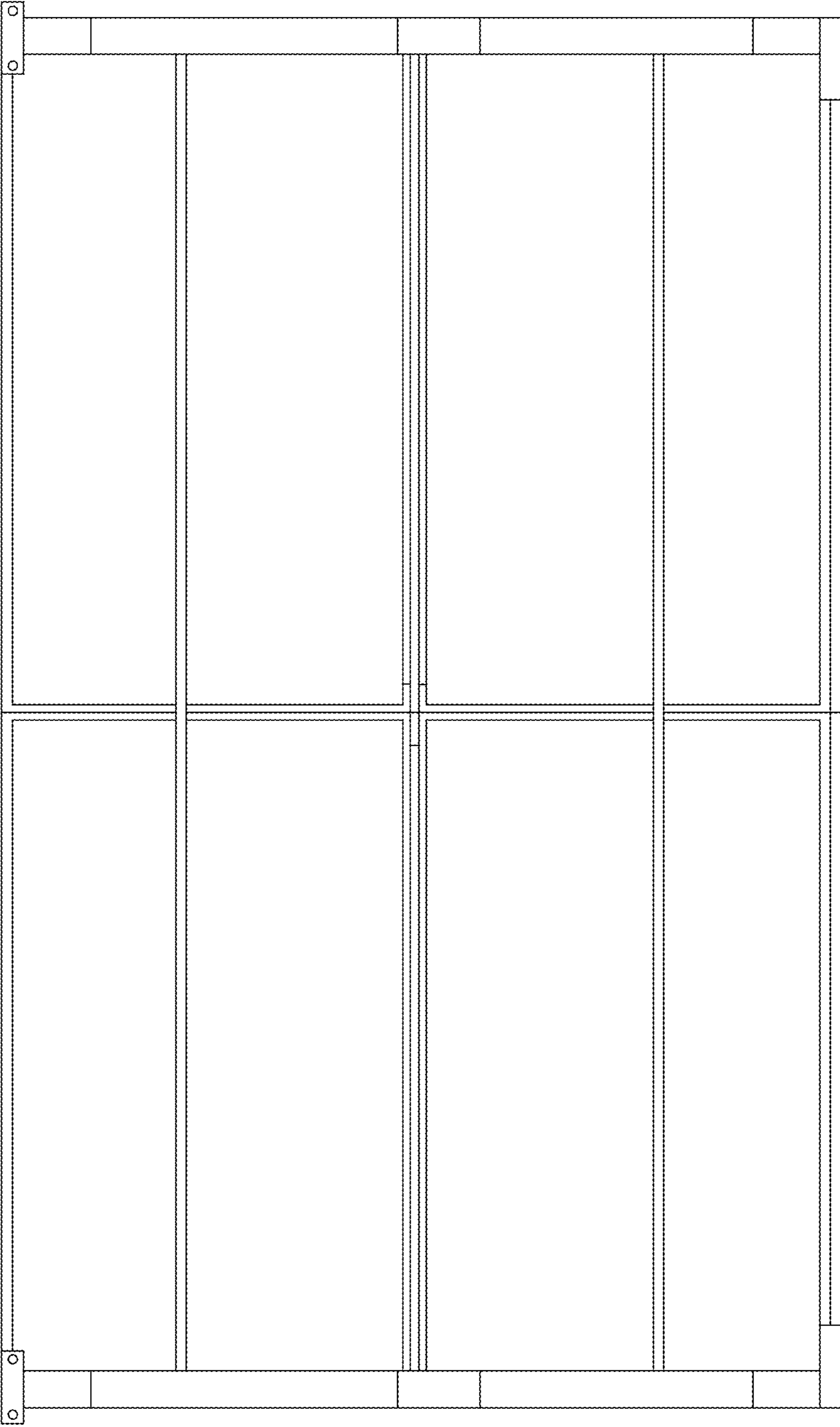

FIG - 7