



US00D801230S

(12) **United States Design Patent** (10) **Patent No.:** **US D801,230 S**  
**Endo** (45) **Date of Patent:** **\*\* Oct. 31, 2017**

(54) **MOTORCYCLE**  
(71) Applicant: **SUZUKI MOTOR CORPORATION**,  
Shizuoka-ken (JP)  
(72) Inventor: **Yuta Endo**, Hamamatsu (JP)  
(73) Assignee: **SUZUKI MOTOR CORPORATION**,  
Shizuoka-ken (JP)  
(\*\*) Term: **15 Years**  
(21) Appl. No.: **29/572,743**  
(22) Filed: **Jul. 29, 2016**

(30) **Foreign Application Priority Data**  
Feb. 2, 2016 (JP) ..... 2016-002131  
(51) **LOC (10) Cl.** ..... **12-11**  
(52) **U.S. Cl.**  
USPC ..... **D12/110**  
(58) **Field of Classification Search**  
USPC ..... D12/110, 111, 117; D21/432, 538  
CPC ..... B62K 11/00; B62K 11/02; B62K 11/04;  
B62K 11/10; B62K 17/00; B62K 19/00;  
B62K 2202/00  
See application file for complete search history.

(56) **References Cited**  
U.S. PATENT DOCUMENTS  
D582,316 S \* 12/2008 Stenegard ..... D12/110  
D591,205 S \* 4/2009 Heinrich ..... D12/110  
D597,449 S \* 8/2009 Nagao ..... D12/110  
D601,458 S \* 10/2009 Nagao ..... D12/110  
D605,089 S \* 12/2009 Tanaka ..... D12/110  
D636,708 S \* 4/2011 Katagiri ..... D12/110  
D638,756 S \* 5/2011 Kouchi ..... D12/110  
D651,138 S \* 12/2011 Lai ..... D12/110

D652,769 S \* 1/2012 Kudo ..... D12/110  
D669,821 S \* 10/2012 Nishihara ..... D12/110  
D688,983 S \* 9/2013 Shibuta ..... D12/110  
D689,406 S \* 9/2013 Yasuhara ..... D12/110  
D695,153 S \* 12/2013 Buckan ..... D12/110  
D695,154 S \* 12/2013 Buckan ..... D12/110  
8,827,024 B1 \* 9/2014 Sumi ..... B62K 25/02  
180/227  
D723,429 S \* 3/2015 Hohdorf ..... D12/110  
D735,085 S \* 7/2015 Buckan ..... D12/110  
D736,677 S \* 8/2015 Iimura ..... D12/110  
2012/0318598 A1 \* 12/2012 Fujiyama ..... B60K 5/12  
180/219  
2015/0101875 A1 \* 4/2015 Inayama ..... B60K 13/02  
180/225

\* cited by examiner

*Primary Examiner* — Darlington Ly  
(74) *Attorney, Agent, or Firm* — Studebaker & Brackett  
PC

(57) **CLAIM**

The ornamental design for a motorcycle, as shown and described.

**DESCRIPTION**

FIG. 1 is a front elevation view of a motorcycle showing my new design;  
FIG. 2 is a rear elevation view thereof;  
FIG. 3 is a top plan view thereof;  
FIG. 4 is a bottom plan view thereof;  
FIG. 5 is a right side elevation view thereof;  
FIG. 6 is a left side elevation view thereof;  
FIG. 7 is a front and right side perspective view thereof;  
FIG. 8 is a rear and right side perspective view thereof;  
FIG. 9 is a front and left side perspective view thereof; and,  
FIG. 10 is a rear and left side perspective view thereof.

**1 Claim, 6 Drawing Sheets**

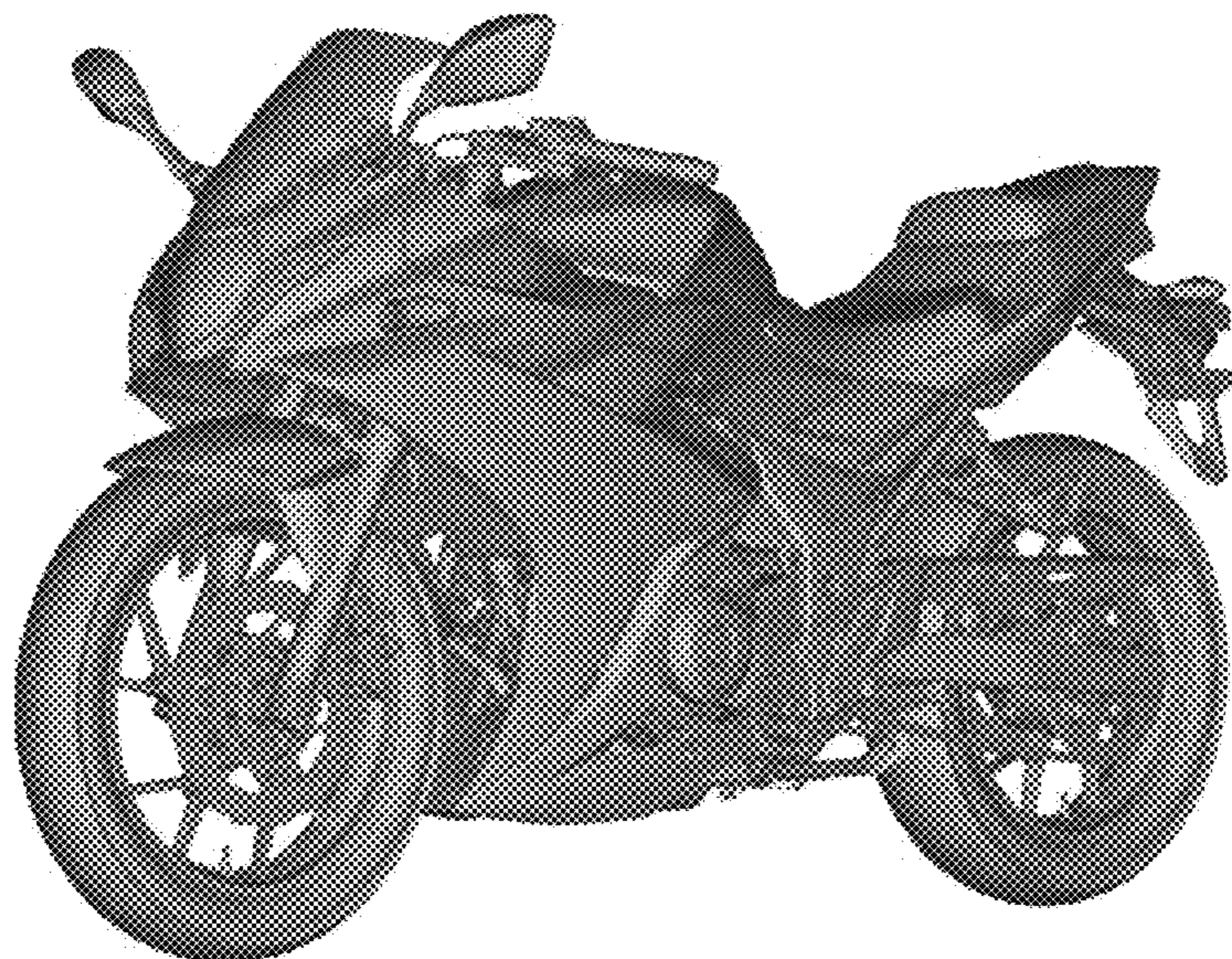

FIG.1

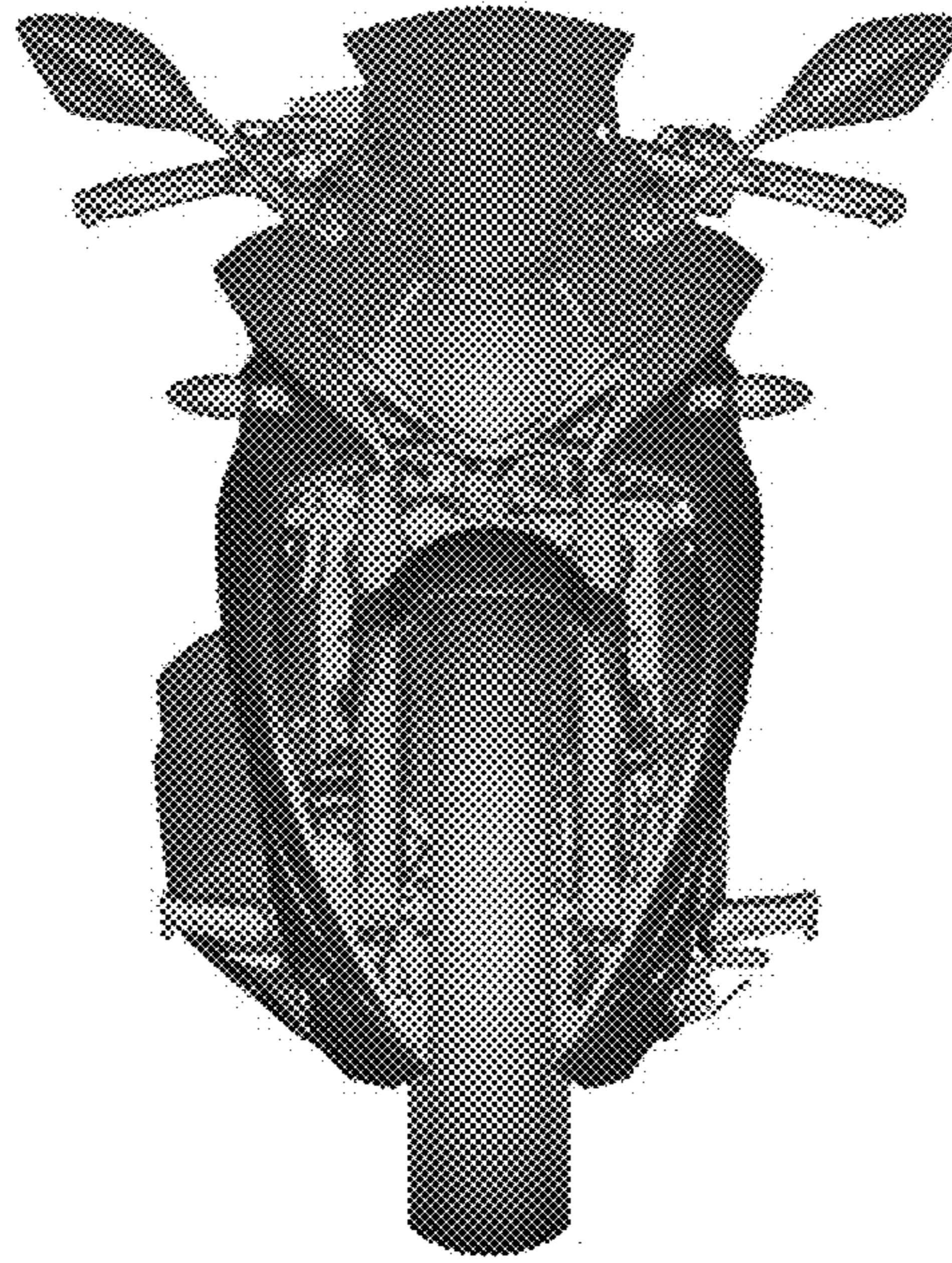

FIG.2

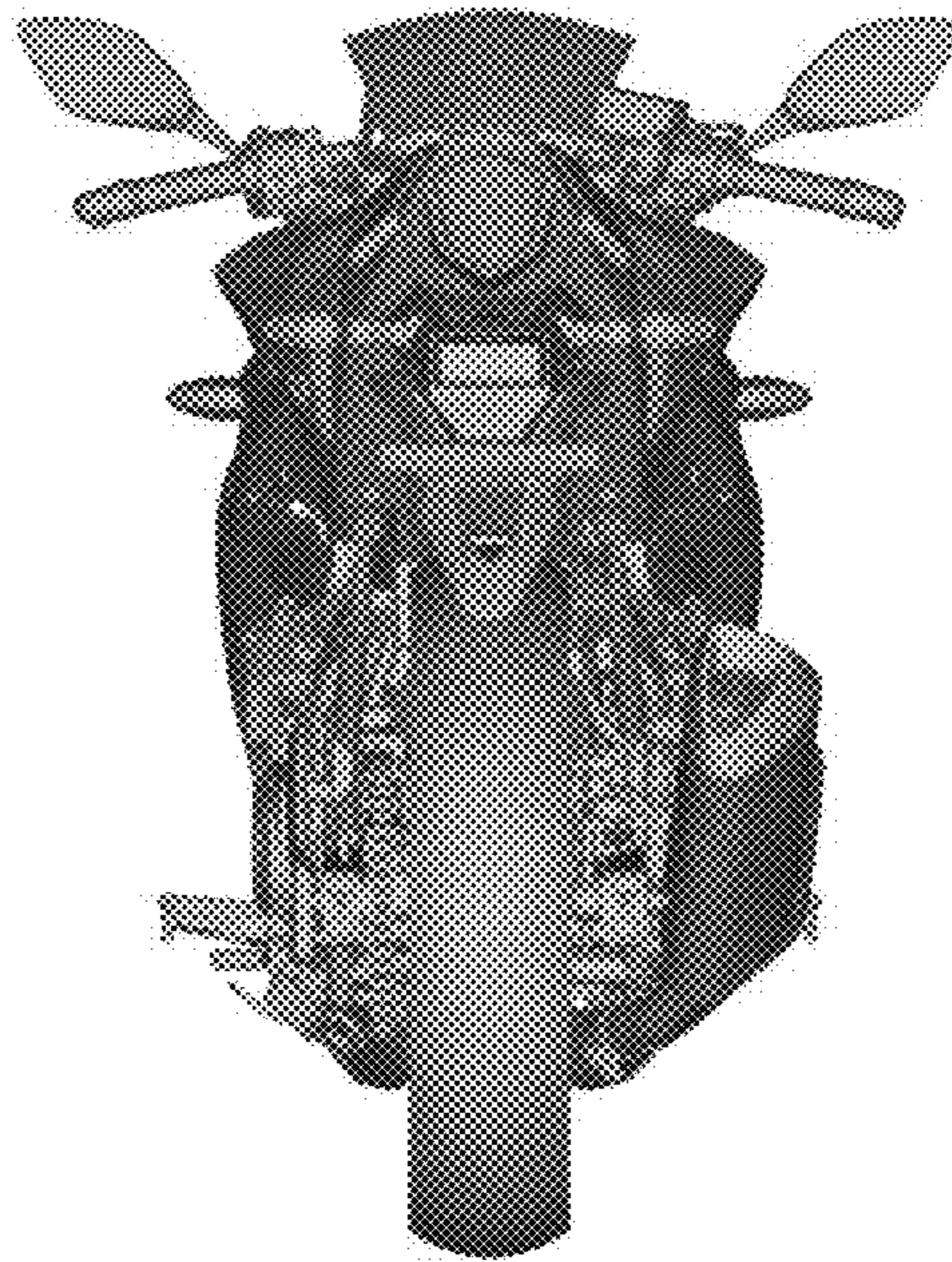

FIG.3

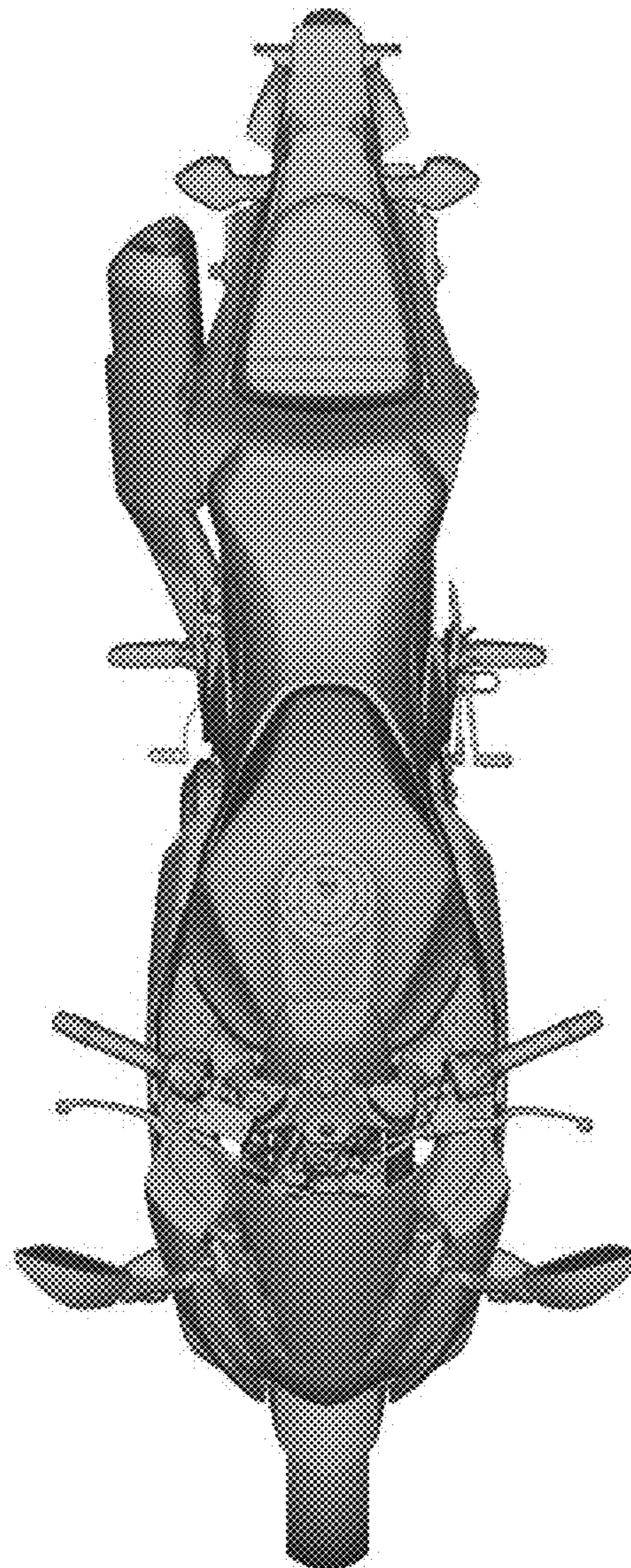

FIG.4

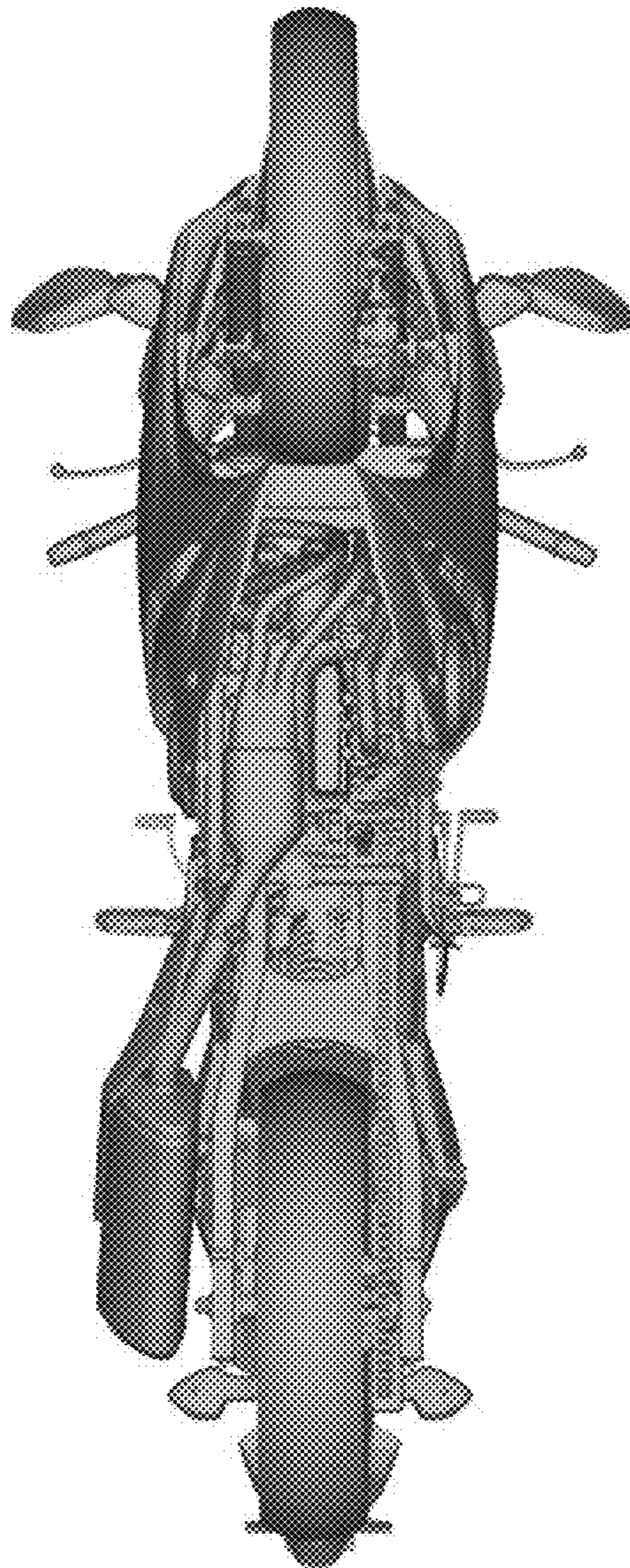

FIG.5

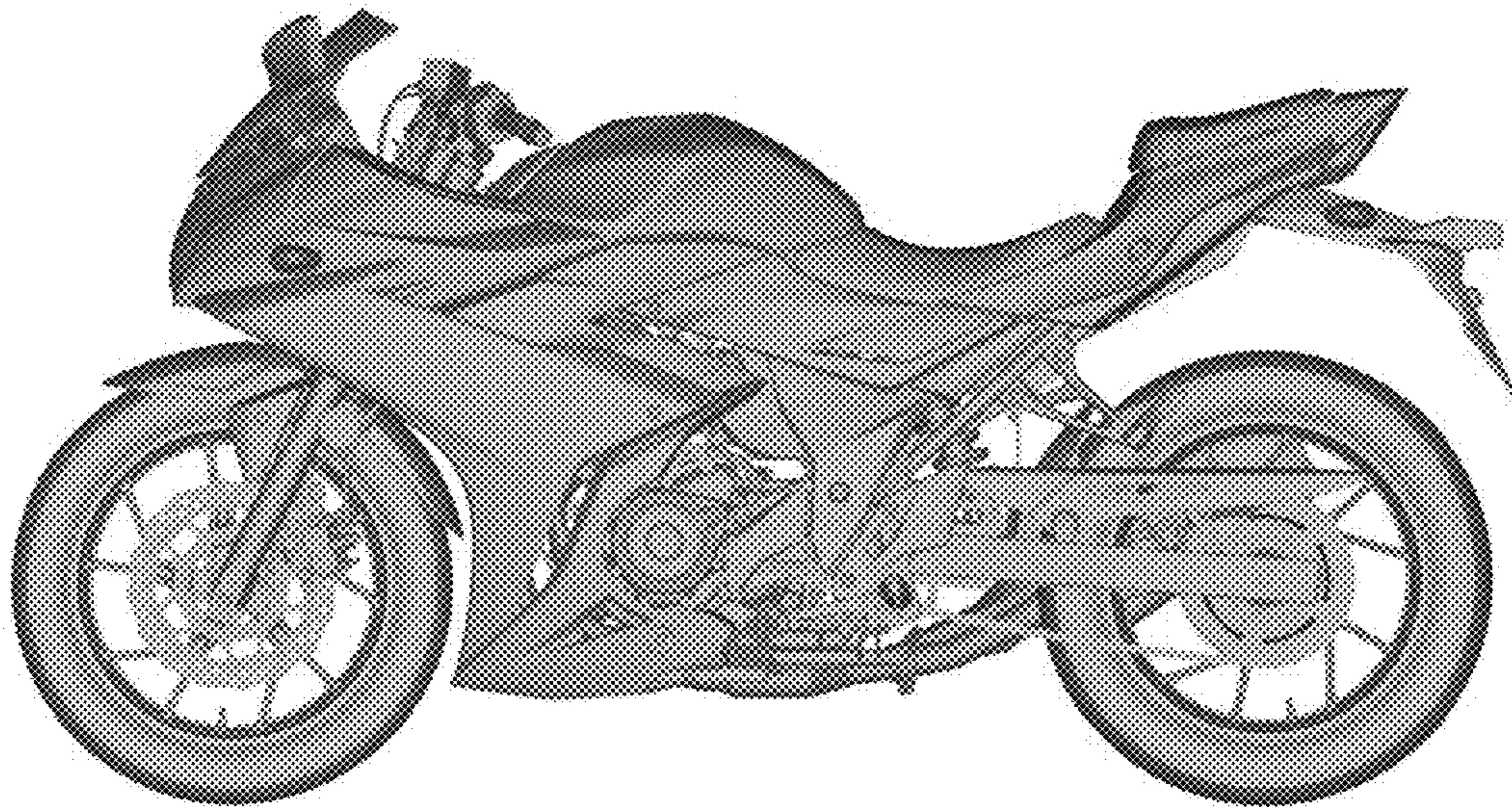

FIG.6

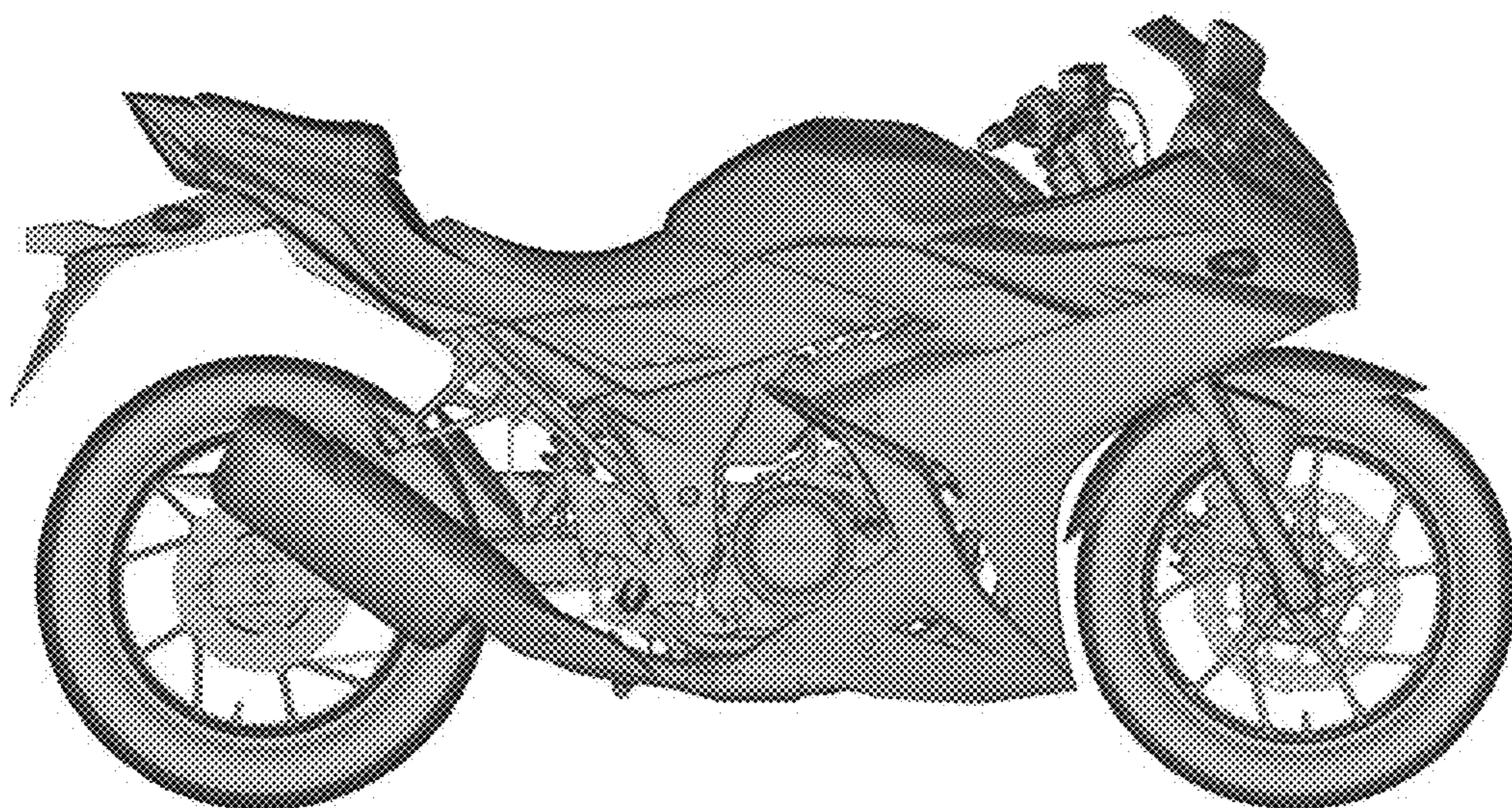

FIG.7

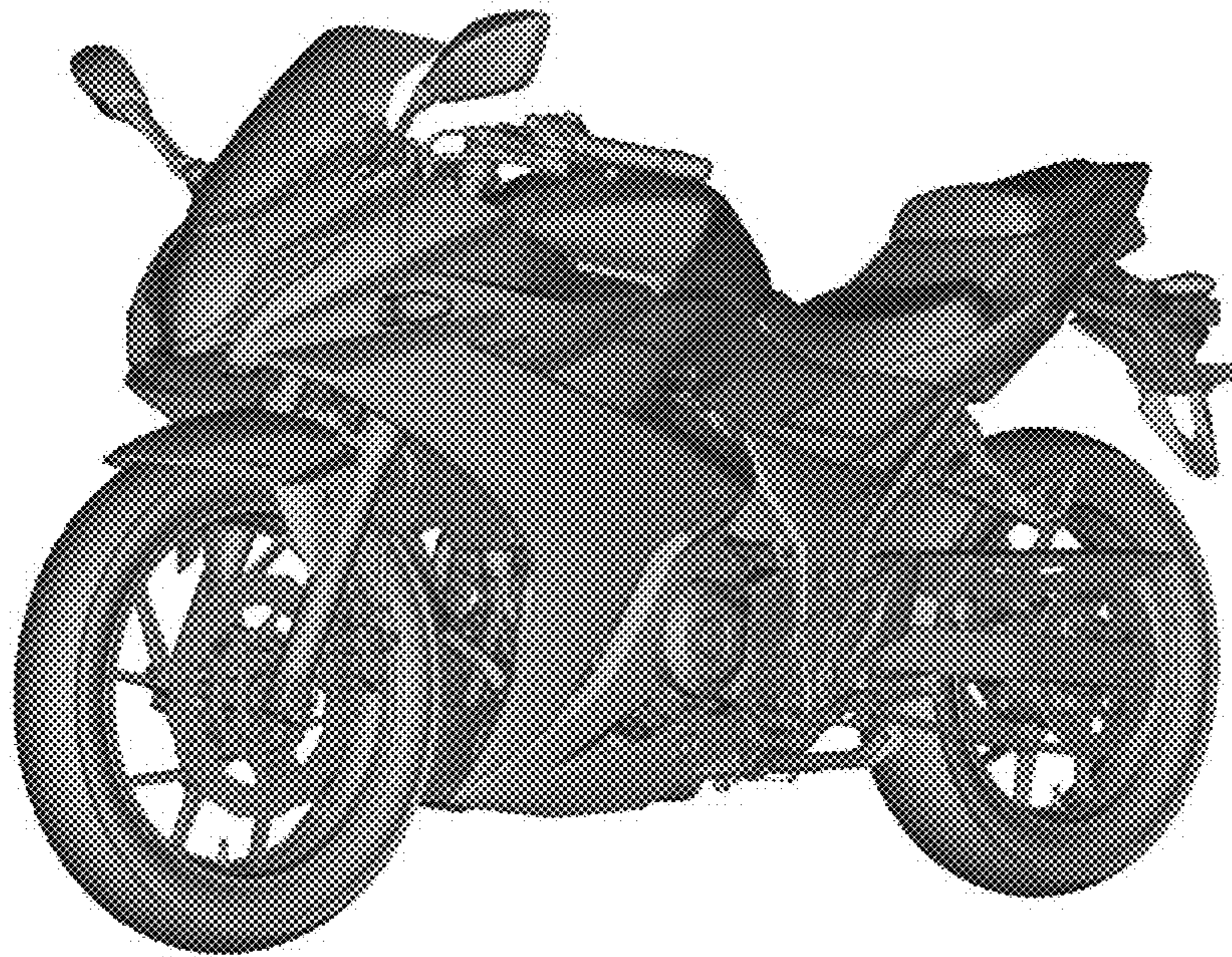

FIG.8

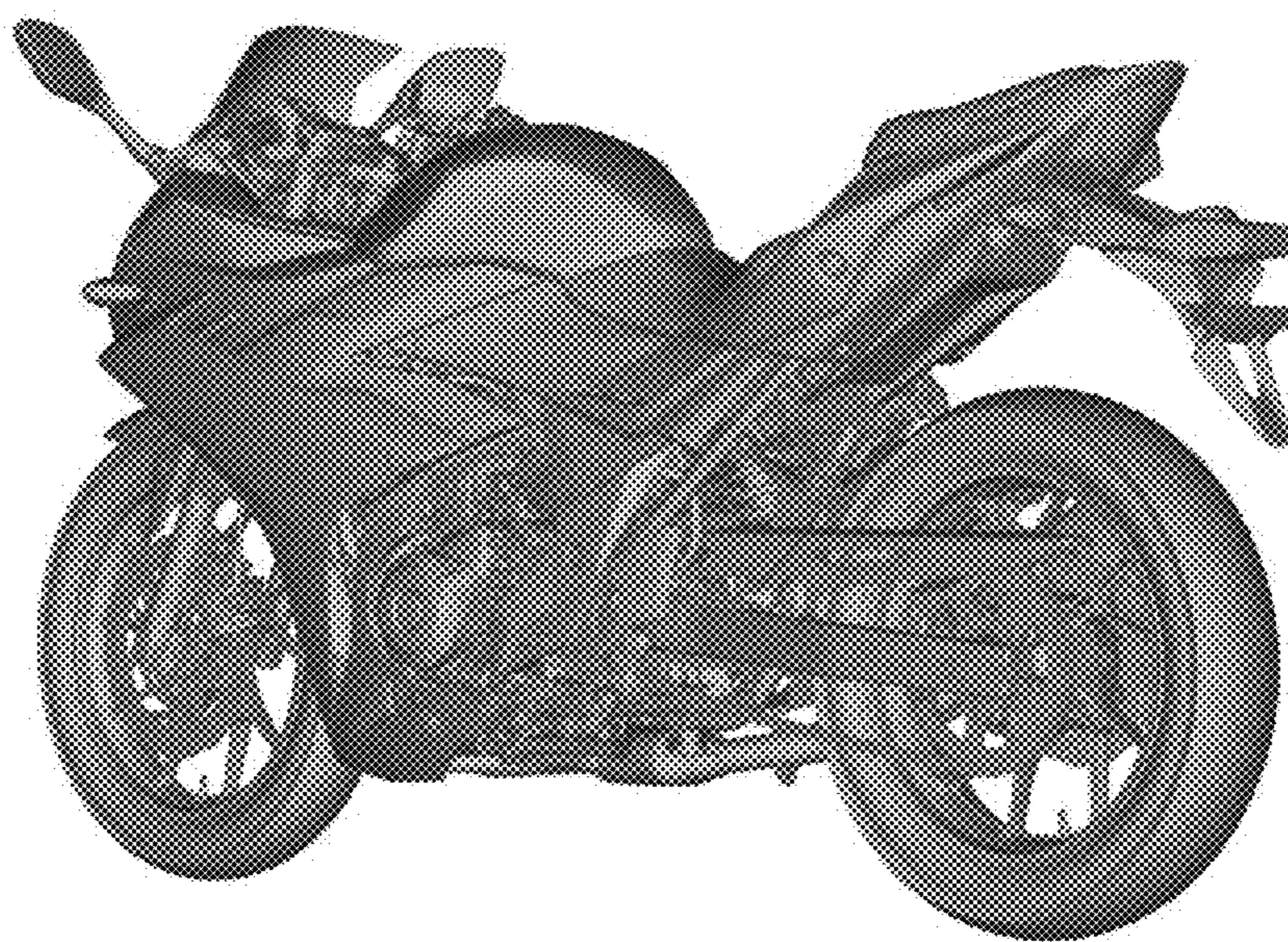

FIG.9

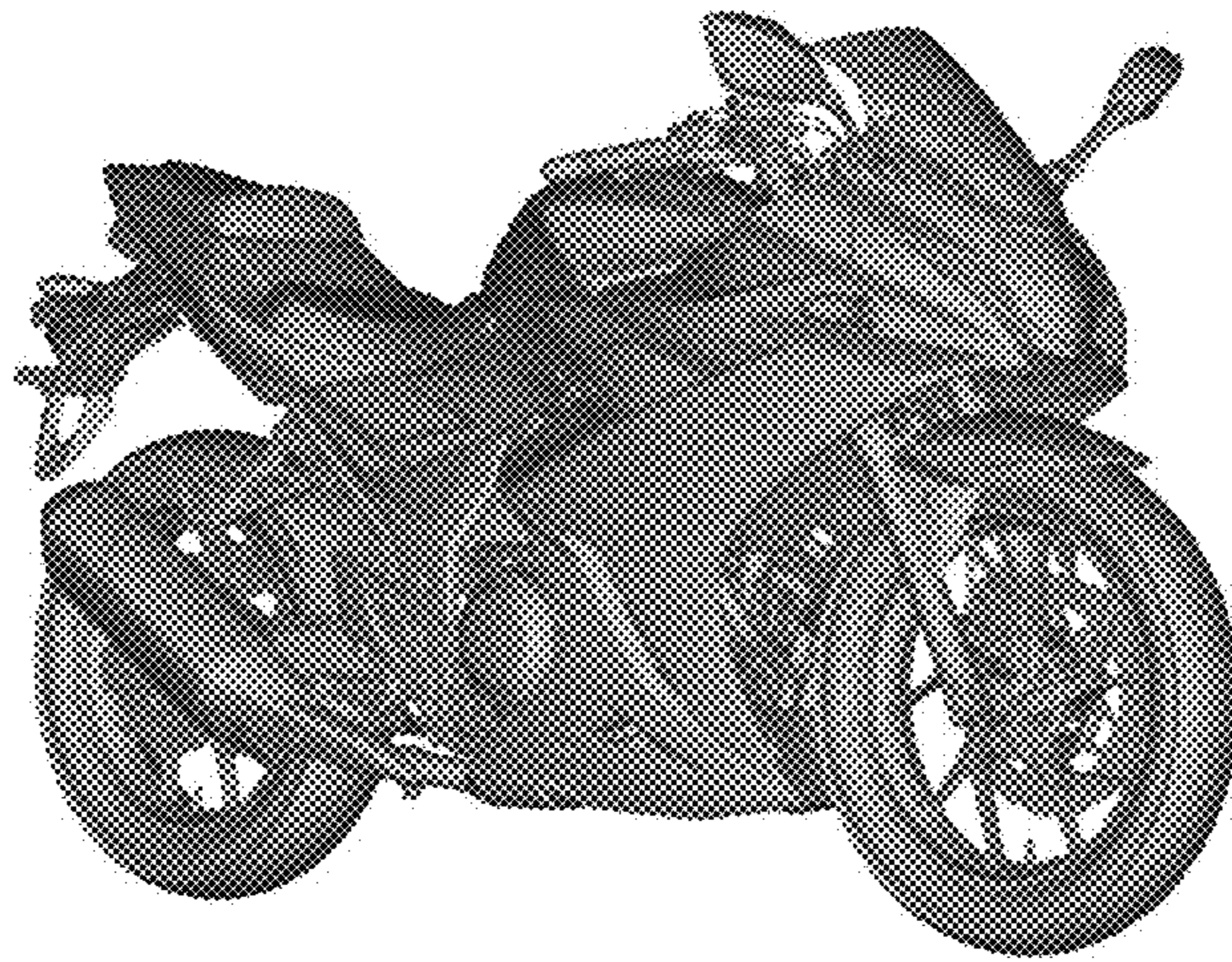

FIG.10

