



US00D801183S

(12) **United States Design Patent** (10) **Patent No.:** **US D801,183 S**  
**Bergeson et al.** (45) **Date of Patent:** **\*\* Oct. 31, 2017**

(54) **BOTTLE**  
(71) Applicant: **The Quaker Oats Company**, Chicago, IL (US)  
(72) Inventors: **Adam Bergeson**, Cedar Rapids, IA (US); **Sean Evelich**, Bridgeport, CT (US); **Eric Thomas Henderson**, Chicago, IL (US); **Terry Lemon**, Hiawatha, IA (US); **James J. Maki**, McHenry, IL (US); **James Troy Starkey**, North Haven, CT (US)

D241,318 S \* 9/1976 Lewman ..... D9/563  
D244,350 S \* 5/1977 Torongo ..... D9/542  
D270,711 S \* 9/1983 Weckman ..... D9/542  
D313,352 S \* 1/1991 Segati ..... D9/542  
D391,170 S \* 2/1998 Lewin ..... D9/542  
D409,092 S \* 5/1999 Beasley ..... D9/516  
D421,391 S 3/2000 Anderson et al.  
D447,955 S \* 9/2001 Beaver ..... D9/542

(Continued)

(73) Assignee: **The Quaker Oats Company**, Chicago, IL (US)

(\*\*) Term: **15 Years**

(21) Appl. No.: **29/583,849**

(22) Filed: **Nov. 9, 2016**

(51) **LOC (10) Cl.** ..... **09-01**

(52) **U.S. Cl.**  
USPC ..... **D9/565**

(58) **Field of Classification Search**  
USPC ..... D9/434-435, 439, 447, 449, 450, 452, D9/454, 516, 520, 522-524, 528-531, D9/541-544, 549-551, 558-560, 563, D9/565-566, 571-575, 682, 686, 687, D9/693-694, 715, 719; D7/300, 300.1, D7/316, 317, 598; D23/211, 225  
CPC ... B65D 1/00; B65D 1/02; B65D 1/12; B65D 1/18; B65D 1/20; B65D 1/0223; B65D 23/00; B65D 21/0237; B65D 2501/0009; B65D 2501/0081

See application file for complete search history.

(56) **References Cited**

**U.S. PATENT DOCUMENTS**

D214,874 S \* 8/1969 Vanderhyde ..... D9/542  
D217,591 S \* 5/1970 Biscoe ..... D9/542

**OTHER PUBLICATIONS**

Palmolive Ultra Dish Liquid. Online, published date unknown. Retrieved on Aug. 14, 2017 from URL: <http://www.couponmamacita.com/tag/palmolive/>.\*

(Continued)

*Primary Examiner* — Vy N Koenig  
*Assistant Examiner* — Omeed Agilee

(74) *Attorney, Agent, or Firm* — James R. Gourley; Celina M. Orr; Carstens & Cahoon, LLP

(57) **CLAIM**

The ornamental design for a bottle, as shown and described.

**DESCRIPTION**

FIG. 1 is a front, top, and left perspective view of a bottle showing our new design, with an unclaimed cap on the bottle;

FIG. 2 is a front view thereof;

FIG. 3 is a rear view thereof;

FIG. 4 is a left side view thereof;

FIG. 5 is a right side view thereof;

FIG. 6 is a top plan view thereof; and,

FIG. 7 is a bottom plan view thereof.

The broken lines in FIGS. 1-6 depicts environmental subject matter, specifically a cap, and forms no part of the claimed design. The broken lines shown in FIG. 7 depicts portions of the bottle that form no part of the claimed design.

**1 Claim, 5 Drawing Sheets**

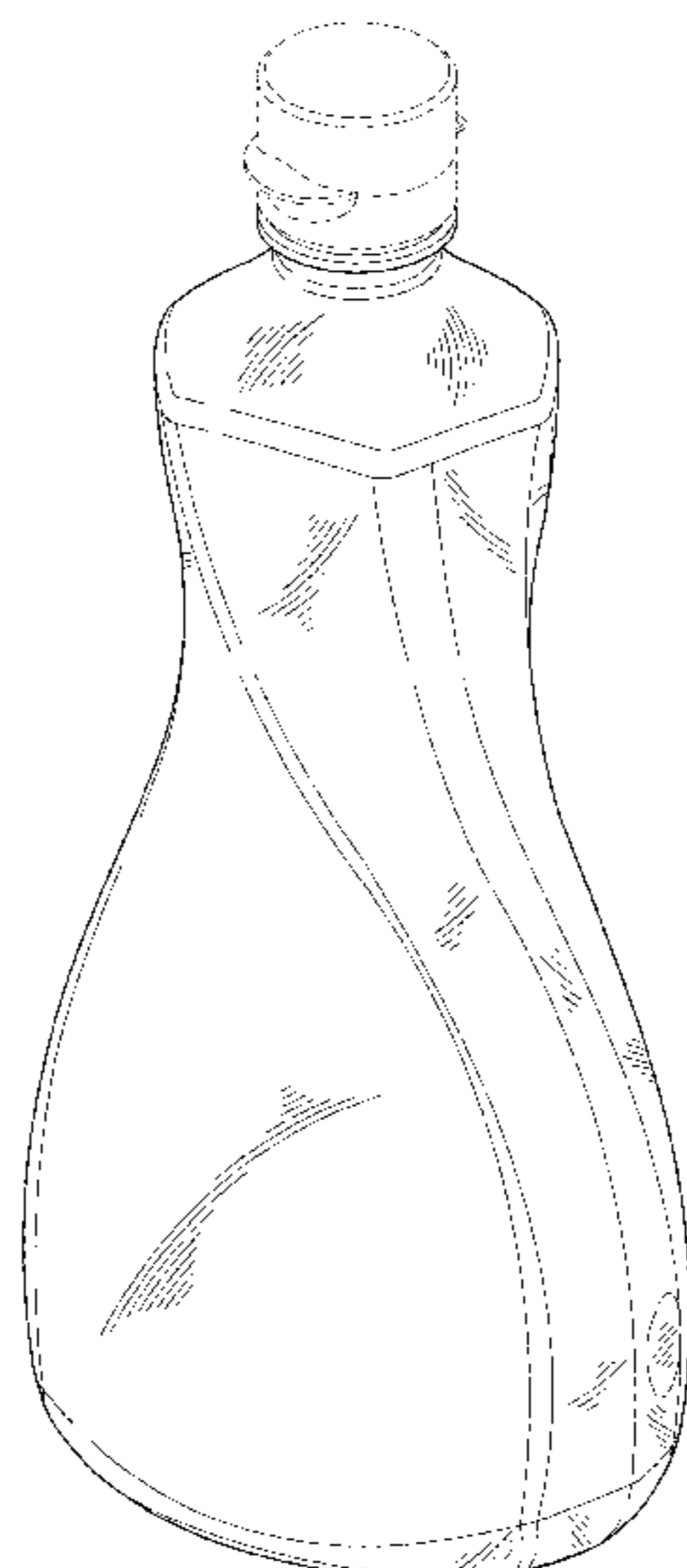

(56)

**References Cited**

U.S. PATENT DOCUMENTS

D489,270	S	*	5/2004	Crawford	.....	D9/542
D546,689	S	*	7/2007	Bourne	.....	D9/538
D547,997	S	*	8/2007	Parcels	.....	D7/319
D594,341	S	*	6/2009	Casey	.....	D9/542
D610,010	S	*	2/2010	Schwartz	.....	D9/516
D635,462	S	*	4/2011	Kuzma	.....	D9/542
D650,689	S	*	12/2011	Schwartz	.....	D9/543
D695,621	S	*	12/2013	Marotti	.....	D9/542
D720,228	S		12/2014	Boon		
D741,715	S	*	10/2015	Casscles	.....	D9/542
D746,145	S	*	12/2015	Kuzma	.....	D9/452
D759,490	S	*	6/2016	Cetnar	.....	D9/542

OTHER PUBLICATIONS

Aunt Jemima found after nearly 100 years. Online, published date Sep. 12, 2015. Retrieved on Aug. 14, 2017 from URL: <http://spokesman-recorder.com/2015/09/12/aunt-jemima-found-nearly-100-years/>.\*

\* cited by examiner

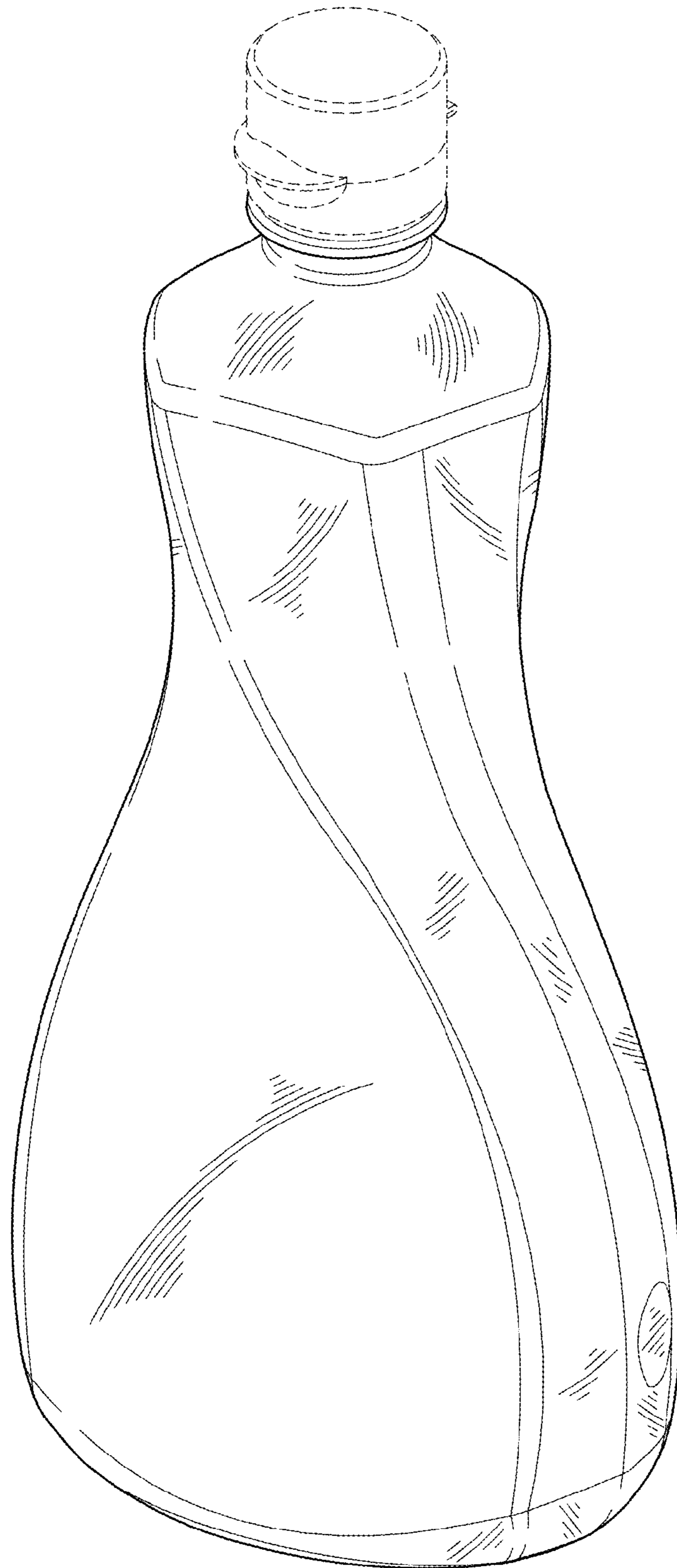

FIG. 1

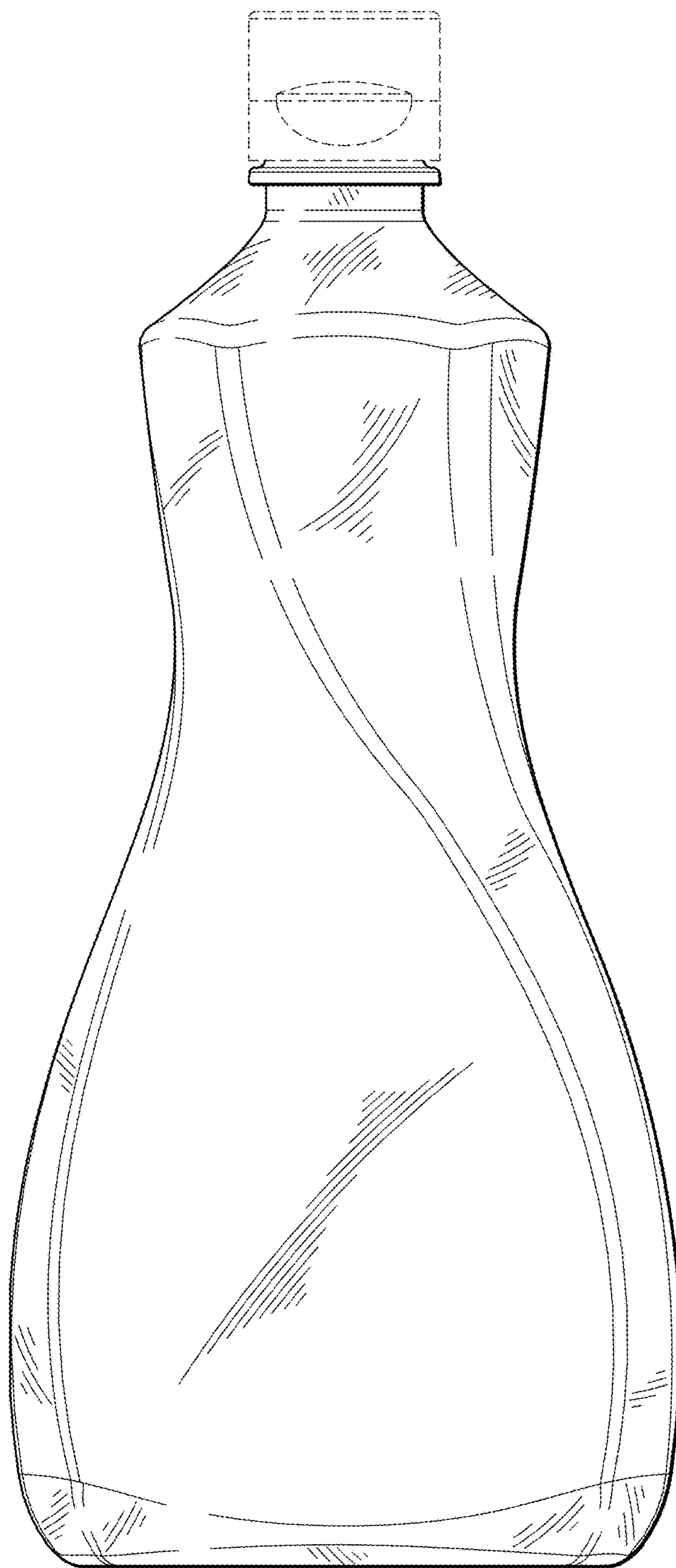

FIG. 2



FIG. 3





FIG. 4

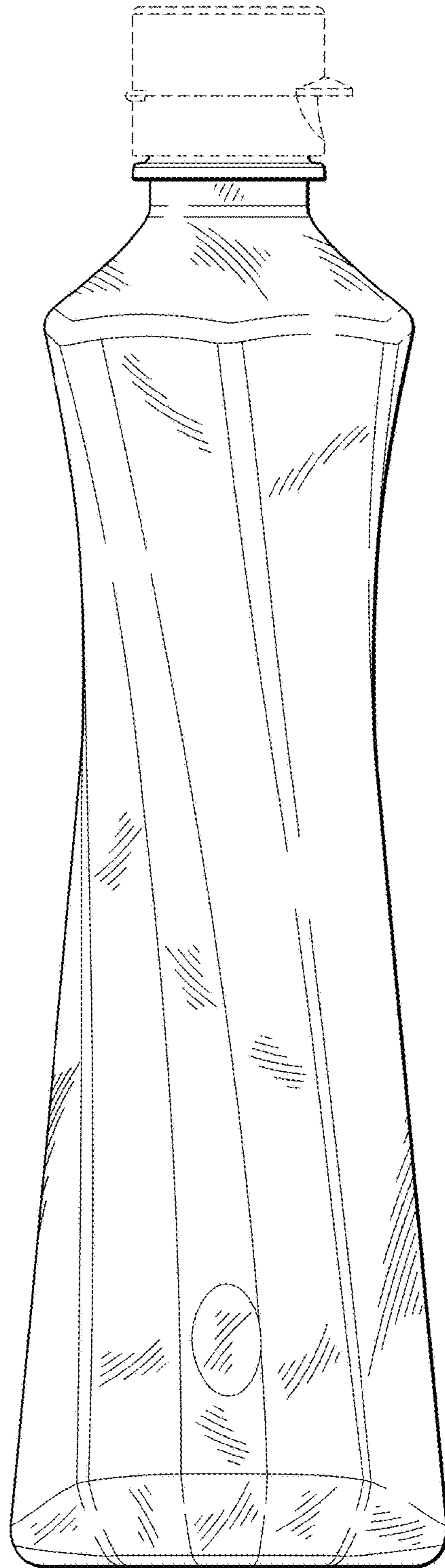

FIG. 5

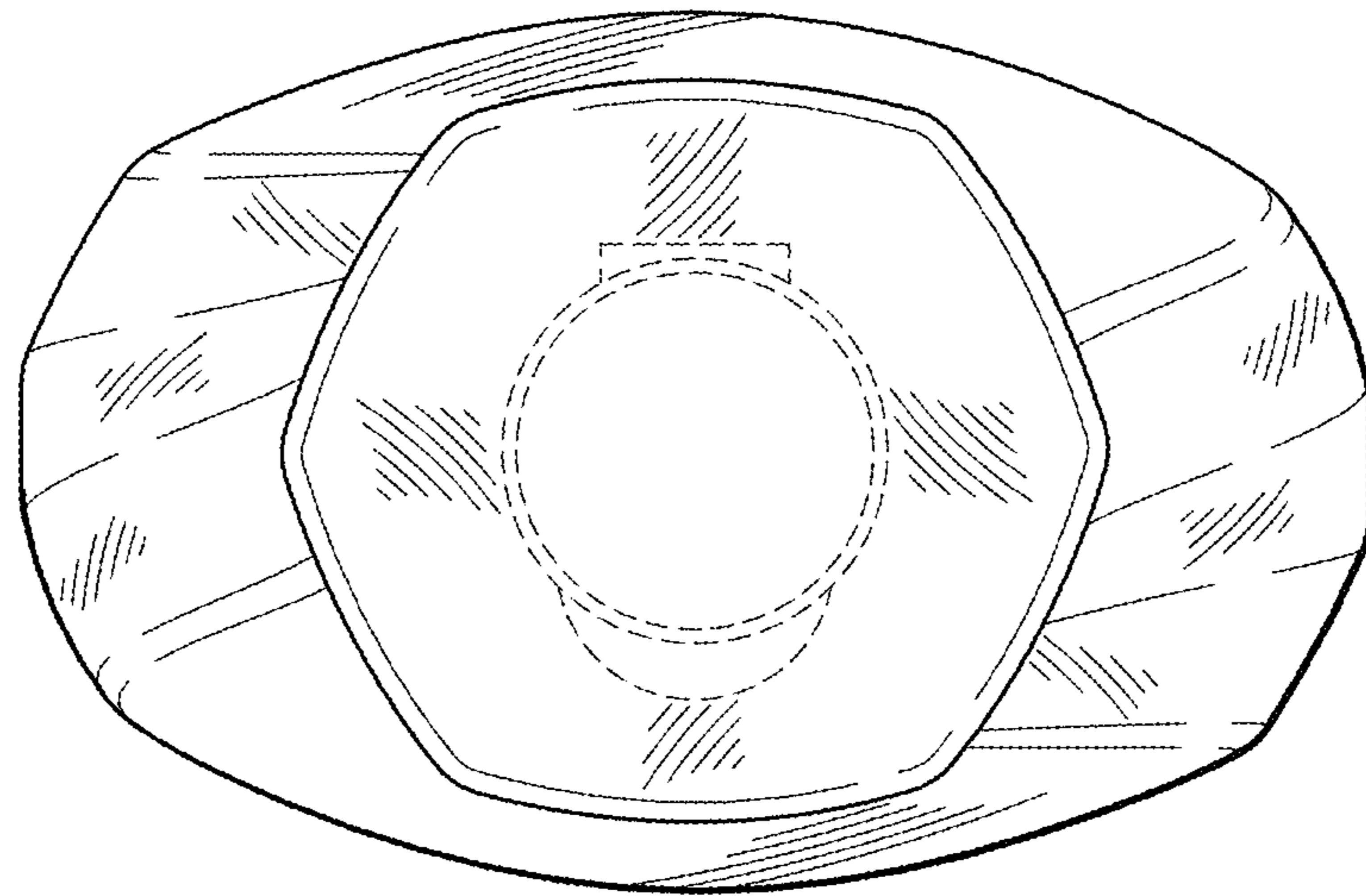

FIG. 6

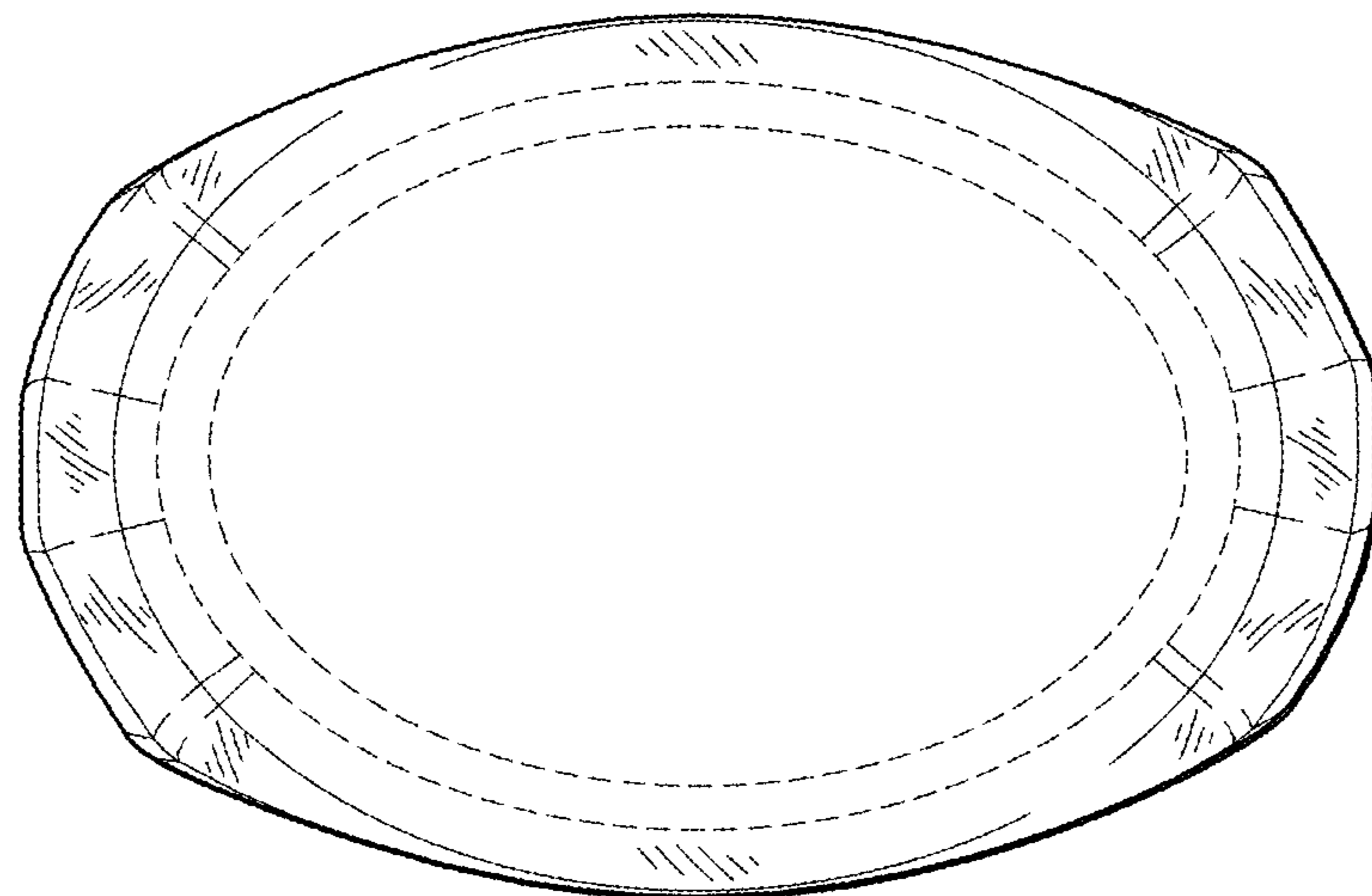

FIG. 7