



US00D801064S

(12) **United States Design Patent**
Von Boetticher

(10) **Patent No.:** **US D801,064 S**

(45) **Date of Patent:** **** Oct. 31, 2017**

(54) **STOOL**

(71) Applicant: **INTERSTUHL BUEROMOEBEL
GMBH & CO. KG, Messstetten (DE)**

(72) Inventor: **Sven Von Boetticher, Stuttgart (DE)**

(73) Assignee: **Interstuhl Bueromoebel GmbH & Co.
KG, Messstetten (DE)**

(**) Term: **15 Years**

(21) Appl. No.: **29/570,642**

(22) Filed: **Jul. 11, 2016**

(30) **Foreign Application Priority Data**

Jan. 18, 2016 (EP) 002948695

(51) **LOC (10) Cl.** **06-01**

(52) **U.S. Cl.**
USPC **D6/352**

(58) **Field of Classification Search**
USPC D6/349-353, 358-360, 364-367,
D6/370-371, 374, 403-405, 601,
D6/691-691.9, 692-692.6, 703.6, 703.7,
D6/705, 716.1; D25/62-65
CPC A47C 9/00-9/105; A47C 7/00-7/02; A47C
16/00-16/04; A47B 7/00-7/02; A47B
3/00; A47B 3/02; A47B 3/04; A47B 3/12
See application file for complete search history.

(56) **References Cited**

U.S. PATENT DOCUMENTS

D109,674 S * 5/1938 Ranko D6/352
D283,856 S * 5/1986 Elmaleh D6/349
D292,147 S * 10/1987 Lomedico D6/349
D313,896 S * 1/1991 Kaye D6/360
D428,721 S * 8/2000 Jenkins D6/364
D458,765 S * 6/2002 Barbieri D6/349
D523,251 S * 6/2006 Parpala D6/352

D581,705 S * 12/2008 Li D6/692.3
D595,969 S * 7/2009 Hanusiak D6/349
D651,422 S * 1/2012 Unterrainer D6/349
D668,464 S * 10/2012 Du D6/353
D671,772 S * 12/2012 Lee D6/692.3
D683,975 S * 6/2013 Starck D6/349
D686,829 S * 7/2013 Elmaleh D6/352
D721,526 S * 1/2015 Bosman D6/692.3
D741,073 S * 10/2015 Keen D6/349
D745,287 S * 12/2015 Chadwick D6/352
D746,073 S * 12/2015 Elmaleh D6/349

(Continued)

OTHER PUBLICATIONS

Interstuhl UPis1. [online] Published on Jul. 2, 2016. Retrieved Jul. 7, 2017 from URL:<<https://www.interstuhl.com/l/us-en/modelle.php?modell=100U>>.*

(Continued)

Primary Examiner — Vy Koenig

(74) *Attorney, Agent, or Firm* — Michael J. Striker

(57) **CLAIM**

The ornamental design for a stool, as shown and described.

DESCRIPTION

FIG. 1 is a top, front and right perspective view of a stool showing my new design;
FIG. 2 is a front elevation view thereof;
FIG. 3 is a rear elevation view thereof;
FIG. 4 is a left side elevation view thereof;
FIG. 5 is a right side elevation view thereof;
FIG. 6 is a top plan view thereof;
FIG. 7 is a bottom plan view thereof;
FIG. 8 is a top, front and right perspective view thereof in an alternate compressed position; and,
FIG. 9 is a rear elevation view thereof in an alternate compressed position.

1 Claim, 8 Drawing Sheets

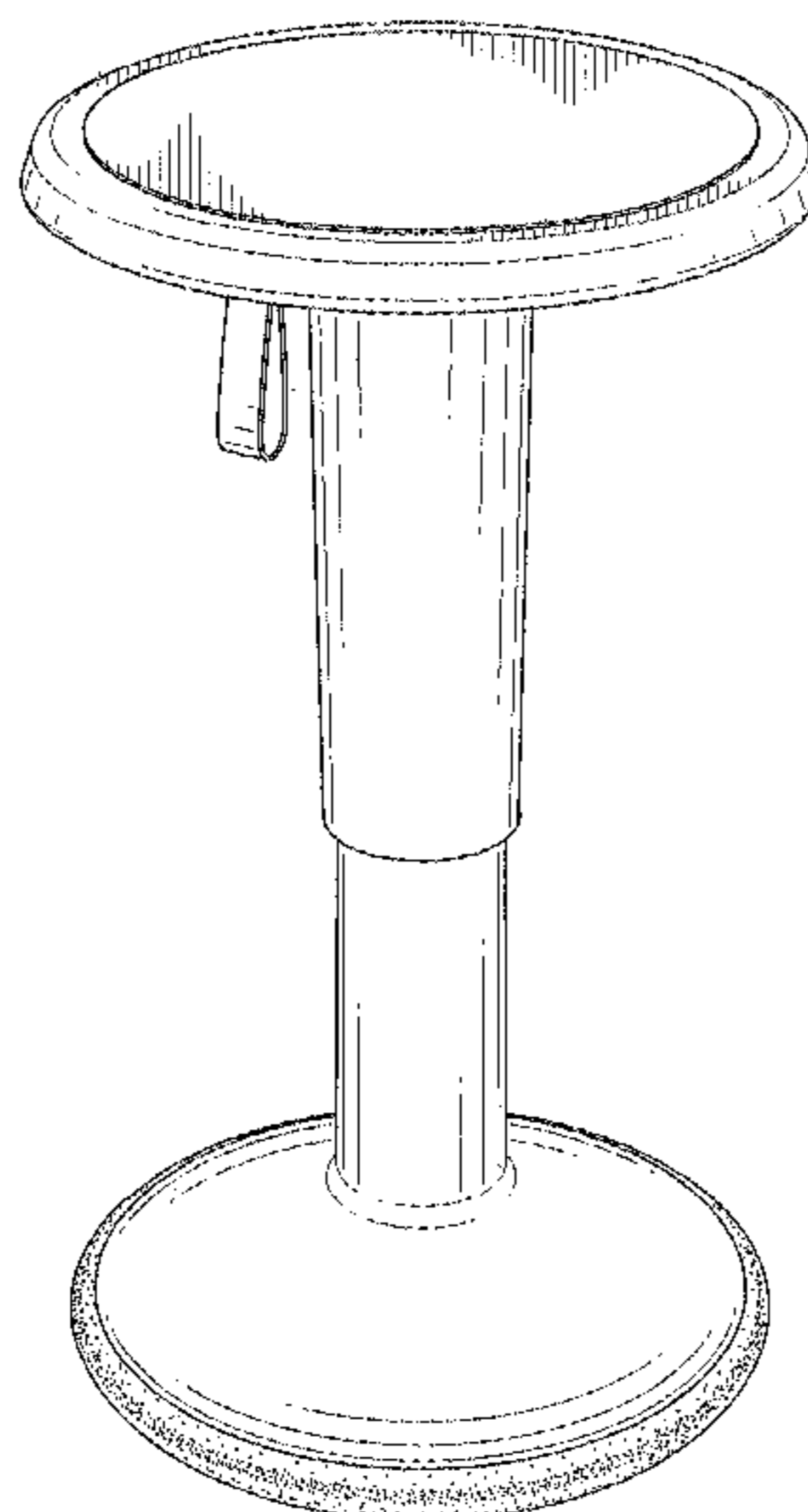

(56)

References Cited

U.S. PATENT DOCUMENTS

D748,924 S * 2/2016 Walser D6/352
D764,200 S * 8/2016 Elmaleh D6/349

OTHER PUBLICATIONS

SitTight. [online] Retrieved Jul. 7, 2017 from URL:<<https://sittight.com/>>.*

Meeting Chair Good Design Award. [online] Published on Apr. 13, 2017. Retrieved Jul. 5, 2017 from URL:<https://www.g-mark.org/award/describe/44078?locale=zh_TW>.*

* cited by examiner

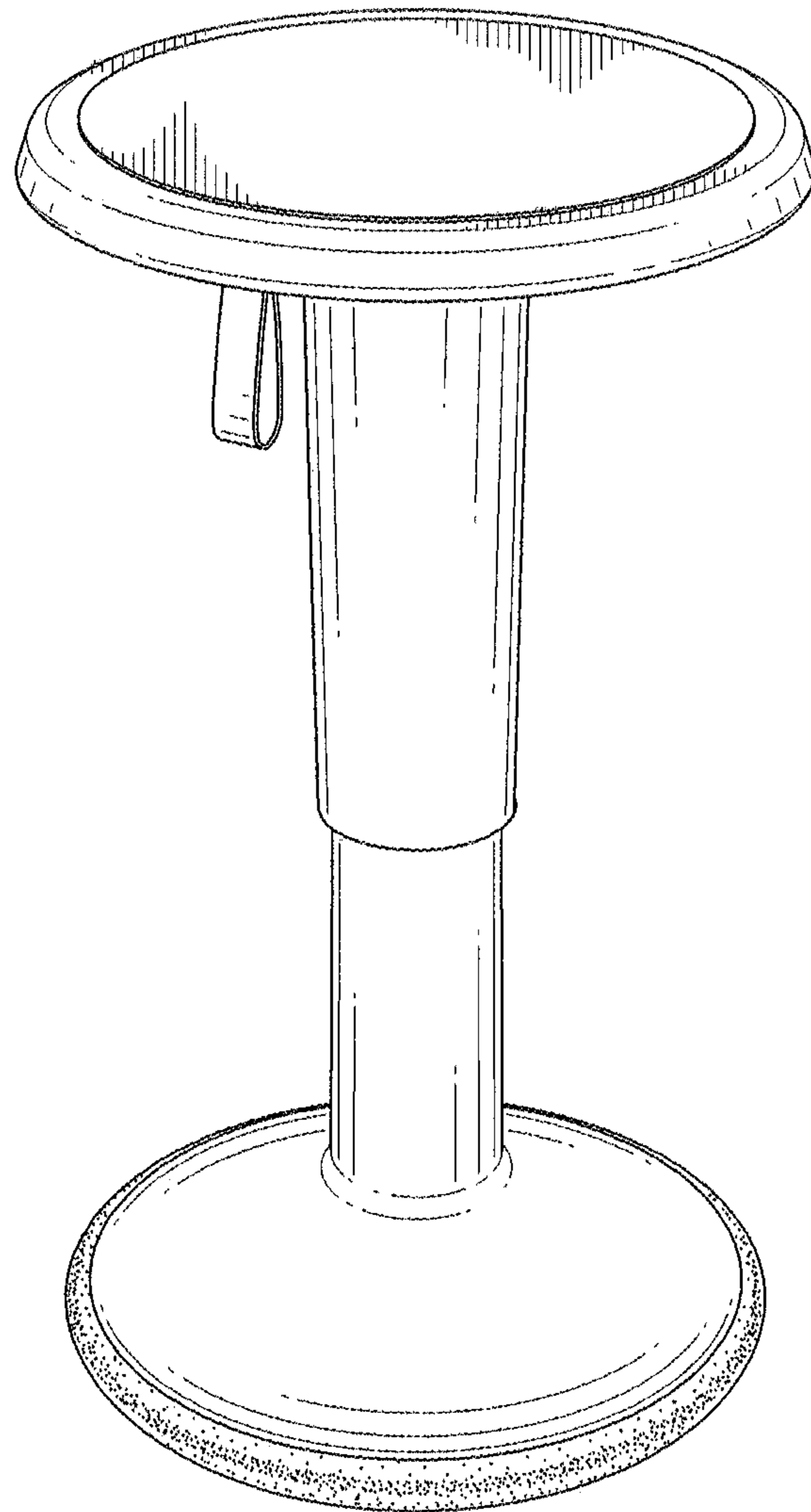

FIG. 1

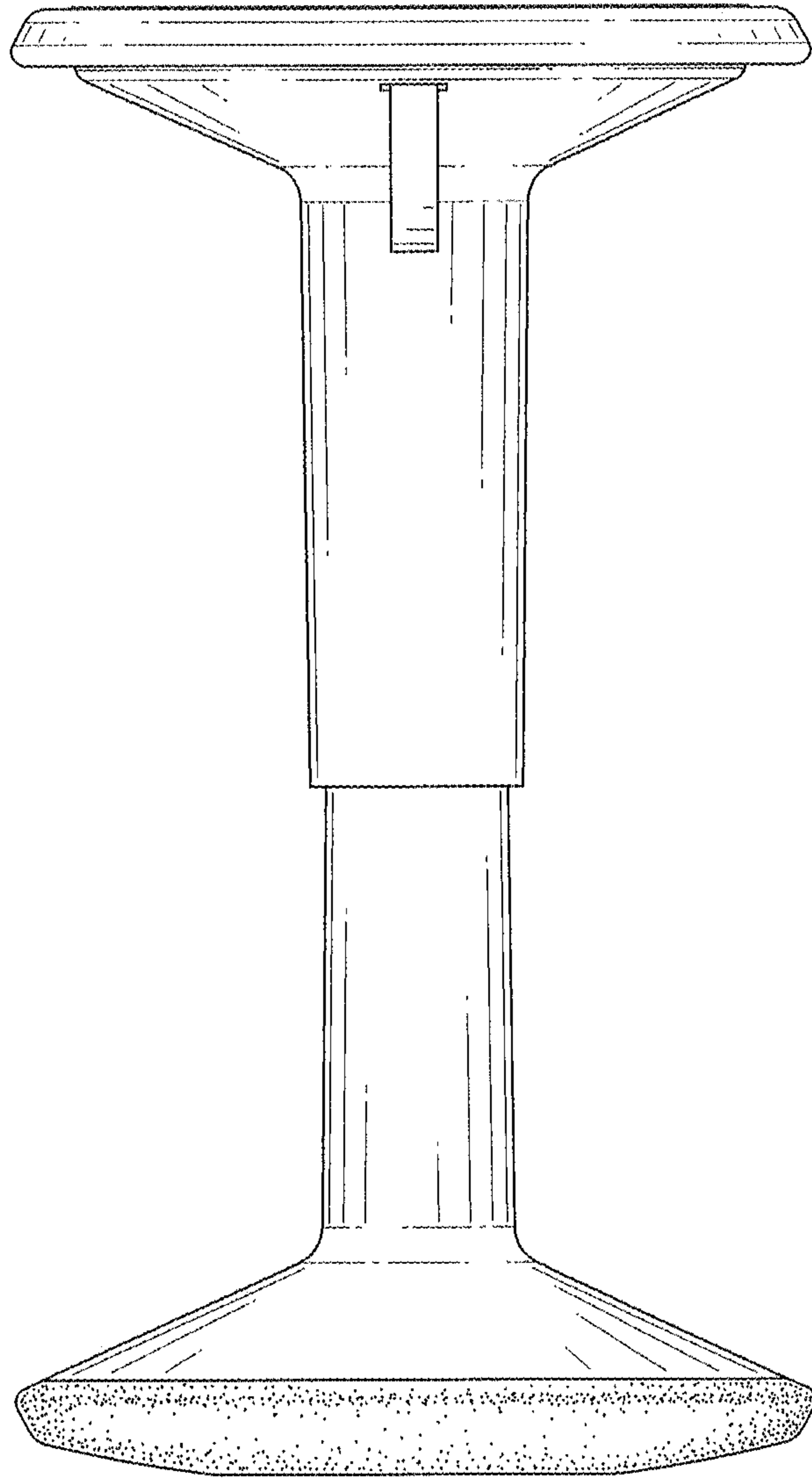

FIG. 2

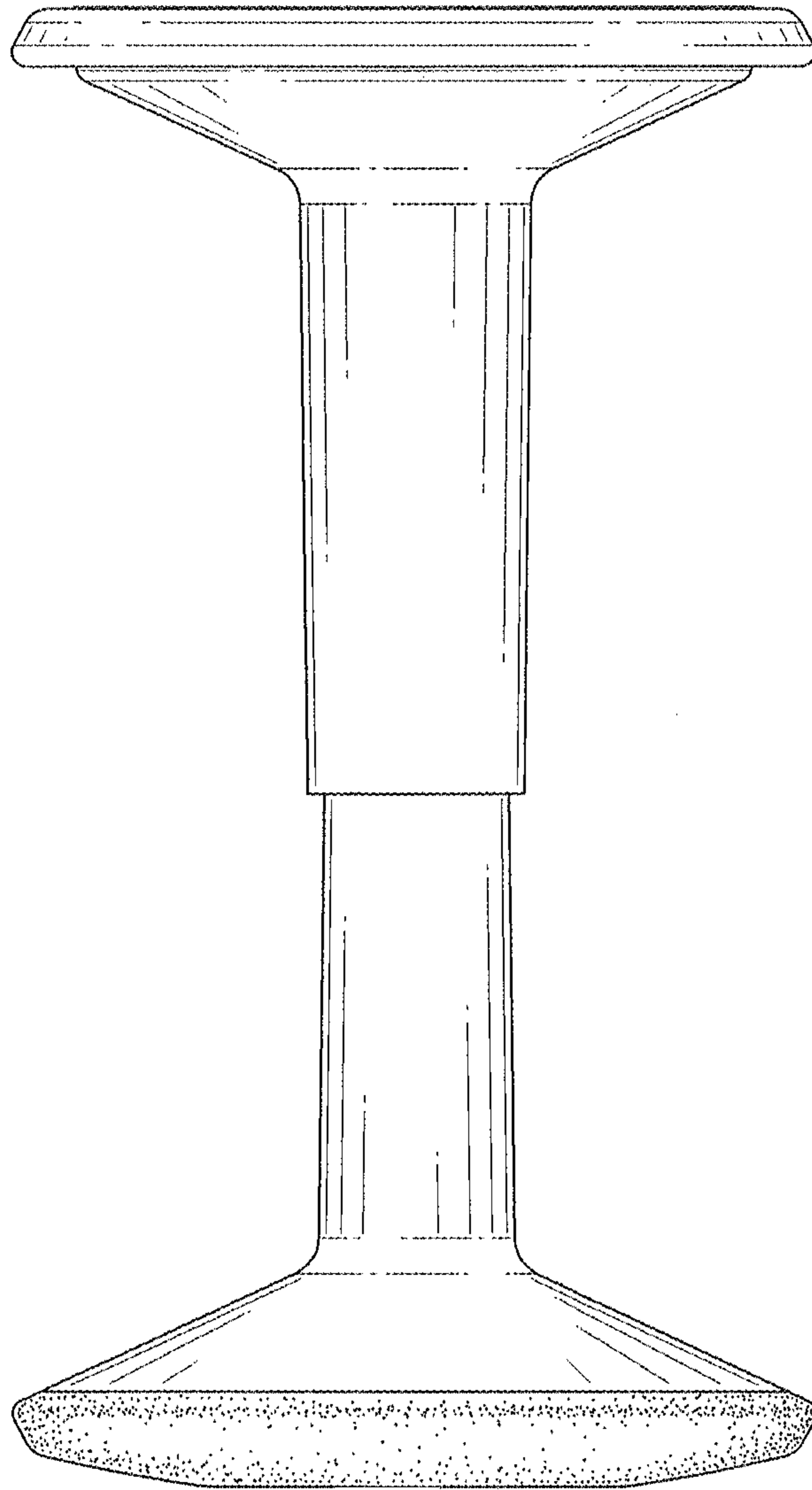

FIG. 3

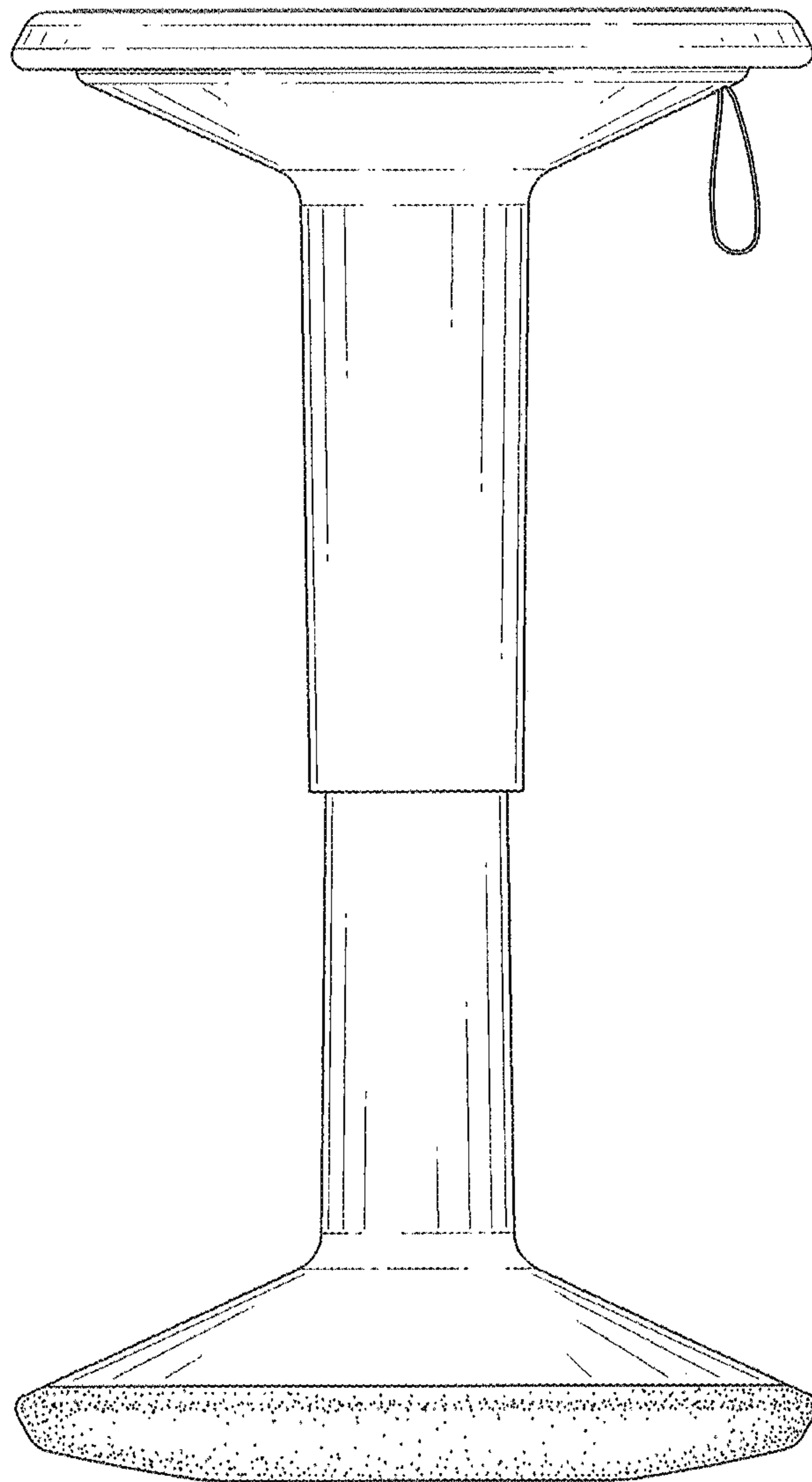

FIG.4

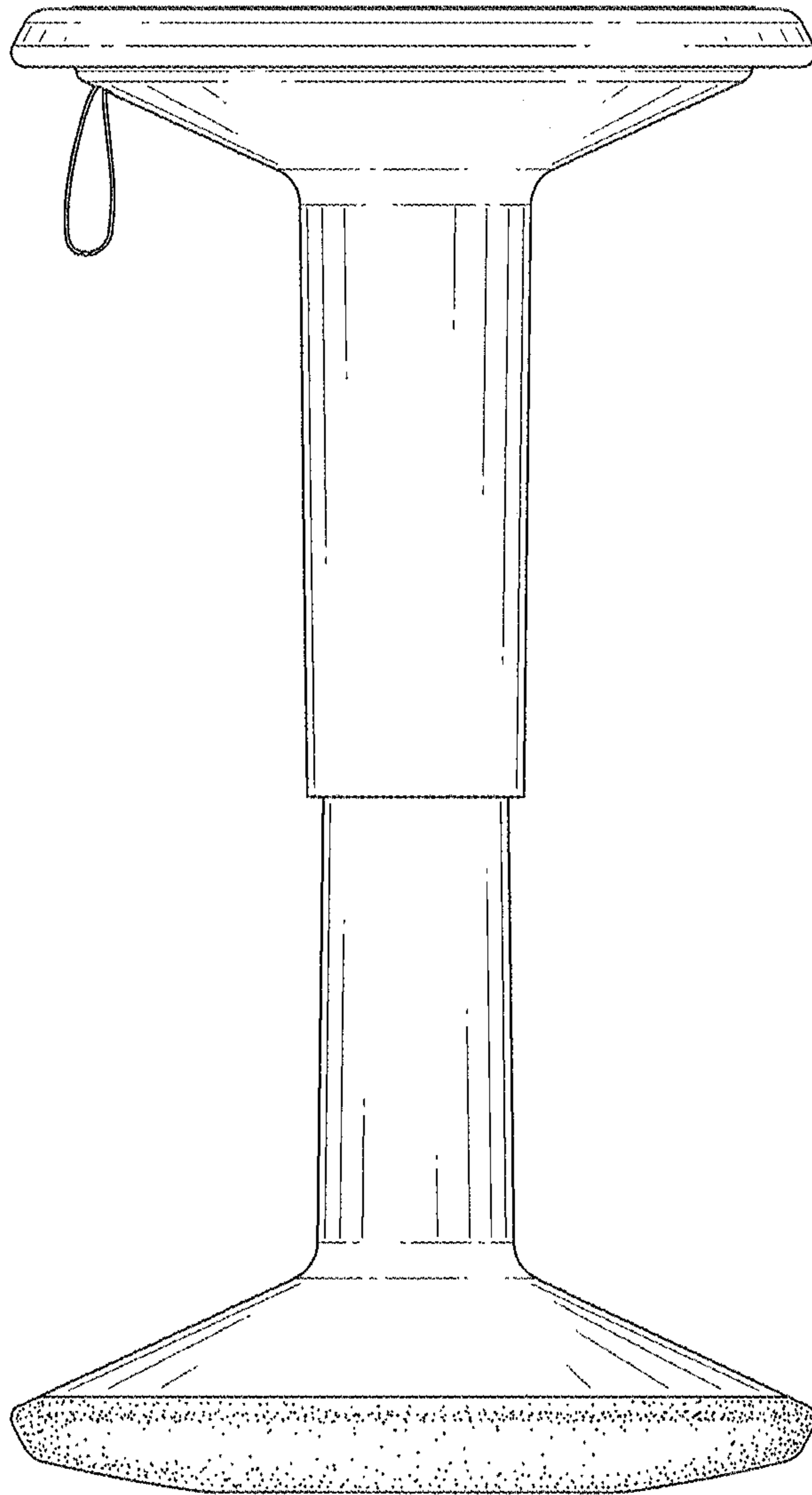

FIG. 5

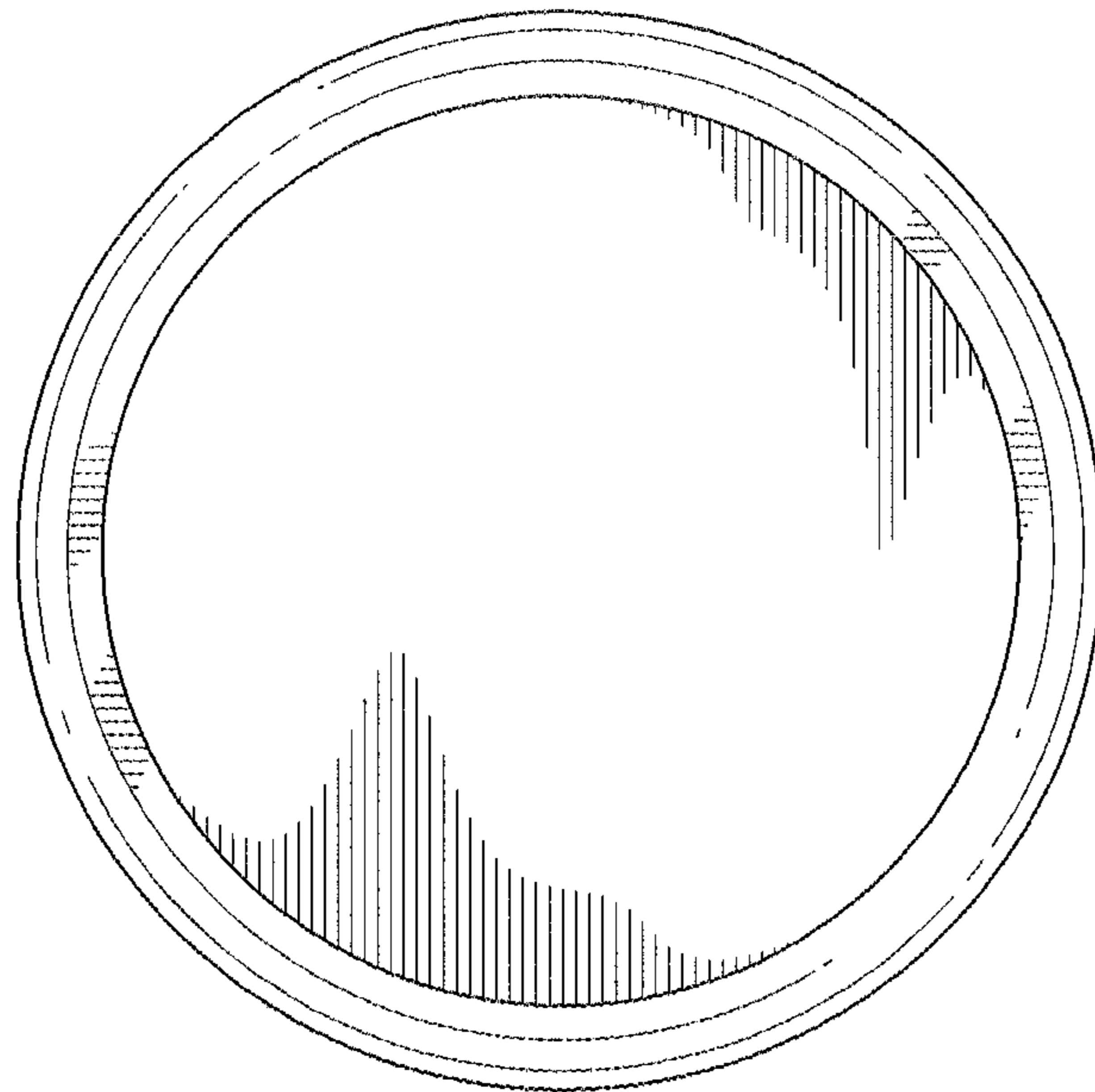

FIG. 6

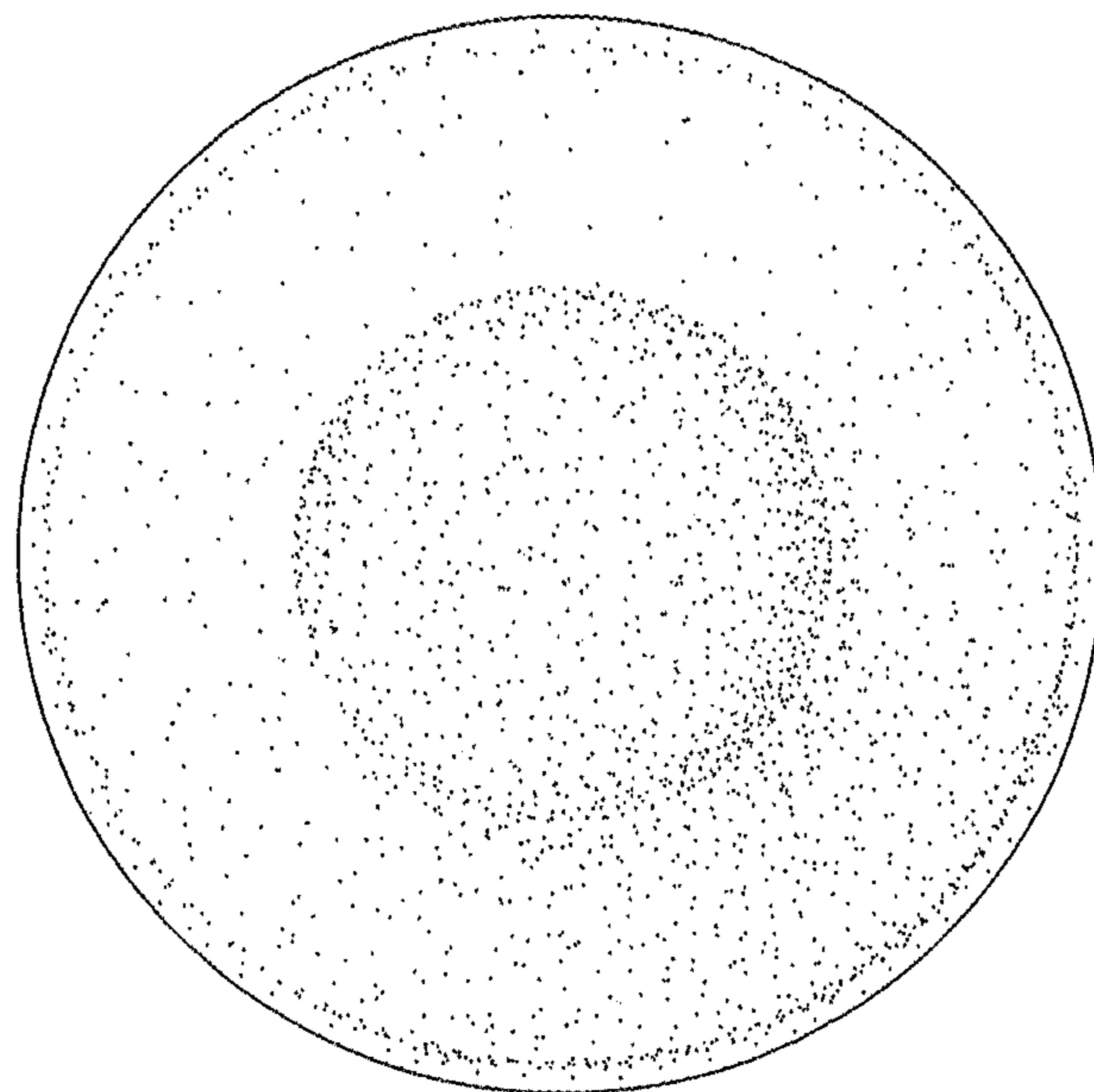

FIG. 7

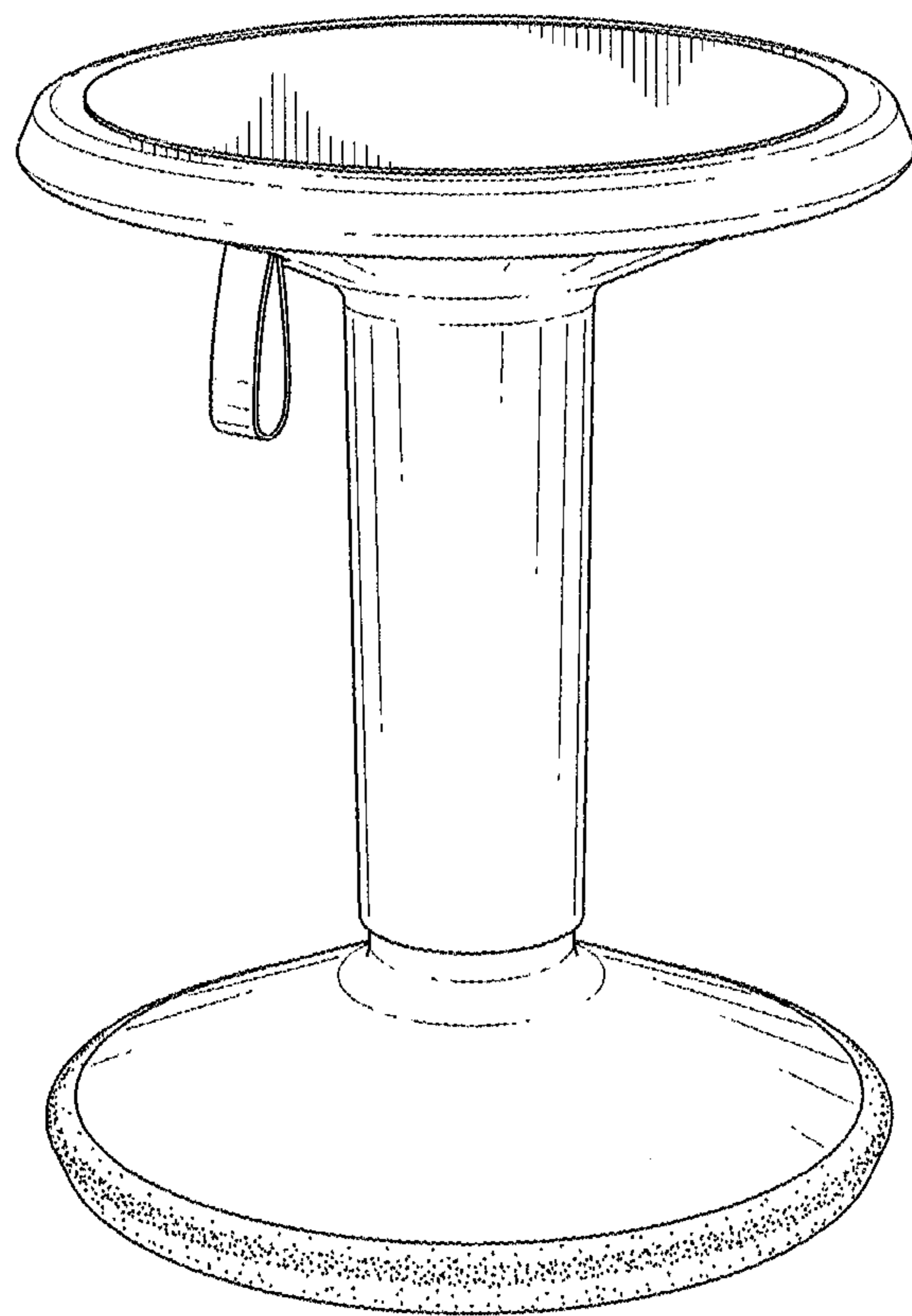

FIG.8

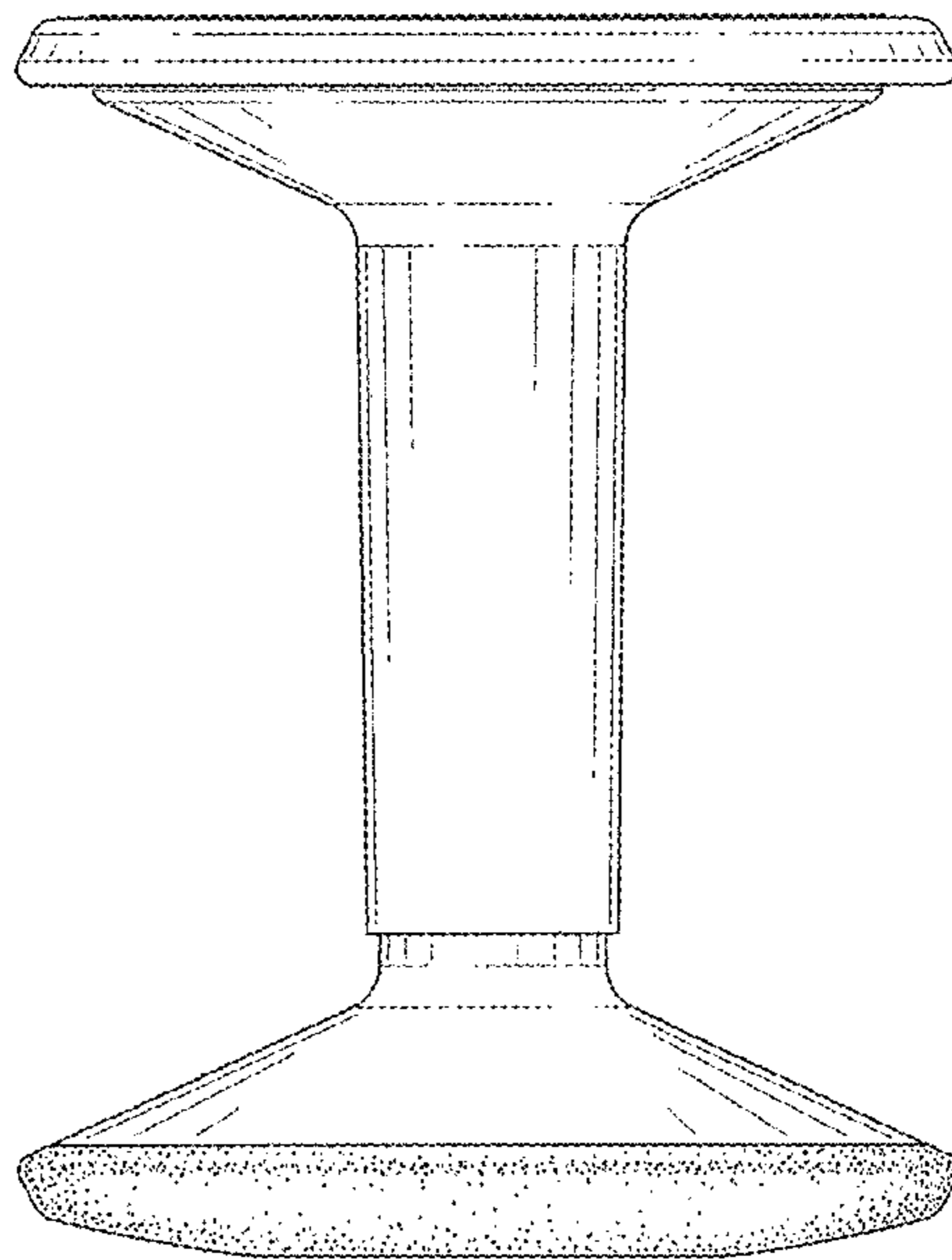

FIG. 9