



US00D801063S

(12) **United States Design Patent** (10) **Patent No.:** **US D801,063 S**
Jia (45) **Date of Patent:** **** Oct. 31, 2017**

(54) **TOILET STOOL**
(71) Applicant: **Eagle Trading USA LLC**, Philadelphia, PA (US)
(72) Inventor: **Shiping Jia**, Montgomery, AL (US)
(73) Assignee: **Eagle Trading USA LLC**, Philadelphia, PA (US)
(**) Term: **15 Years**
(21) Appl. No.: **29/600,982**
(22) Filed: **Apr. 18, 2017**
(51) **LOC (10) Cl.** **06-01**
(52) **U.S. Cl.**
USPC **D6/349**
(58) **Field of Classification Search**
USPC D6/334, 349-355, 363, 360, 368, 374, D6/403, 405, 685, 688.17, 693-693.3, D6/695, 708, 708.15-708.25, 709.11; D25/62-65
CPC A47C 9/00-9/105; A47C 7/00-7/02; A47C 16/00-16/04; A47B 7/00-7/02; A47B 3/00; A47B 3/02; A47B 3/04; A47B 3/12
See application file for complete search history.

D705,554 S 5/2014 Edwards
D716,065 S * 10/2014 Hubbard, Jr. D6/349
D749,330 S * 2/2016 Jahns D6/349
D767,291 S 9/2016 Edwards
D785,351 S * 5/2017 D'Angelo D6/349
D787,846 S * 5/2017 Naik D6/353
2014/0123376 A1 5/2014 Edwards
2015/0327740 A1 11/2015 Edwards

OTHER PUBLICATIONS

Ultraportable Toilet stool—Amazon. [online] Retrieved Jun. 27, 2017 from URL: <https://www.amazon.com/Ultraportable-Toilet-stool-AvailableStackable/dp/B01MQUEYX8/ref=pd_lpo_vtph_121_lp_t_3?_encoding=UTF8&pvc=1&refRID=2J94KFTHDSWWKAATDD8R>.*

* cited by examiner

Primary Examiner — Vy Koenig

(57) **CLAIM**

The ornamental design for a toilet stool, as shown and described.

DESCRIPTION

FIG. 1 is a left side view of the toilet stool showing our new design;
FIG. 2 is a right side view thereof;
FIG. 3 is a back view thereof;
FIG. 4 is a front view thereof;
FIG. 5 is a top view thereof;
FIG. 6 is a bottom view thereof;
FIG. 7 is a top perspective view thereof; and,
FIG. 8 is a bottom perspective view thereof.

1 Claim, 5 Drawing Sheets

(56) **References Cited**

U.S. PATENT DOCUMENTS

D140,212 S * 1/1945 McLane 297/423.41
D287,075 S * 12/1986 Colin 4/547
D407,569 S * 4/1999 Underbrink D6/349
D538,557 S * 3/2007 Martyn D6/349
D553,370 S * 10/2007 Meyers D6/350
D652,222 S 1/2012 Edwards
8,616,652 B1 * 12/2013 Wells A47C 16/025
297/423.14
D698,163 S 1/2014 Edwards

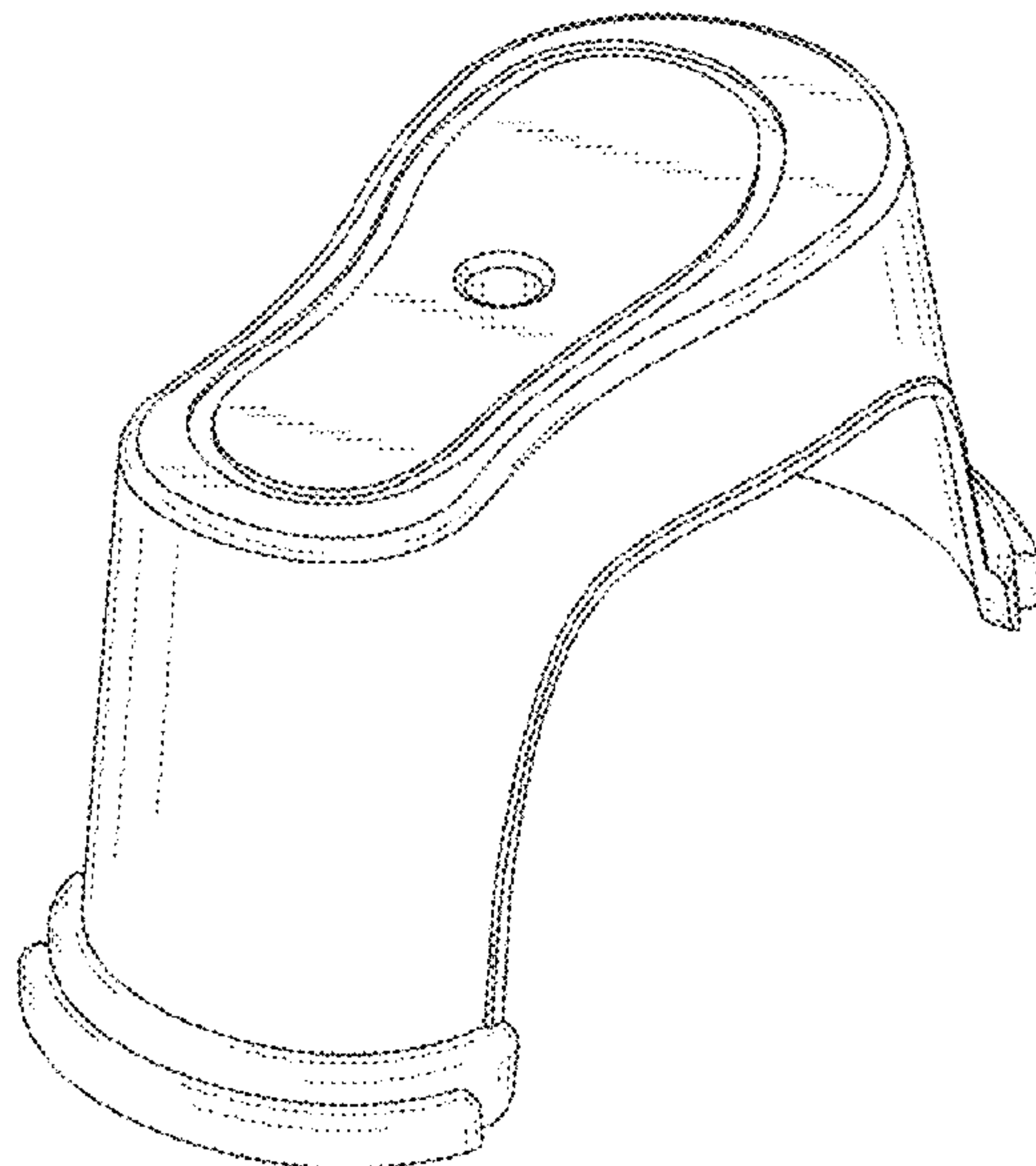

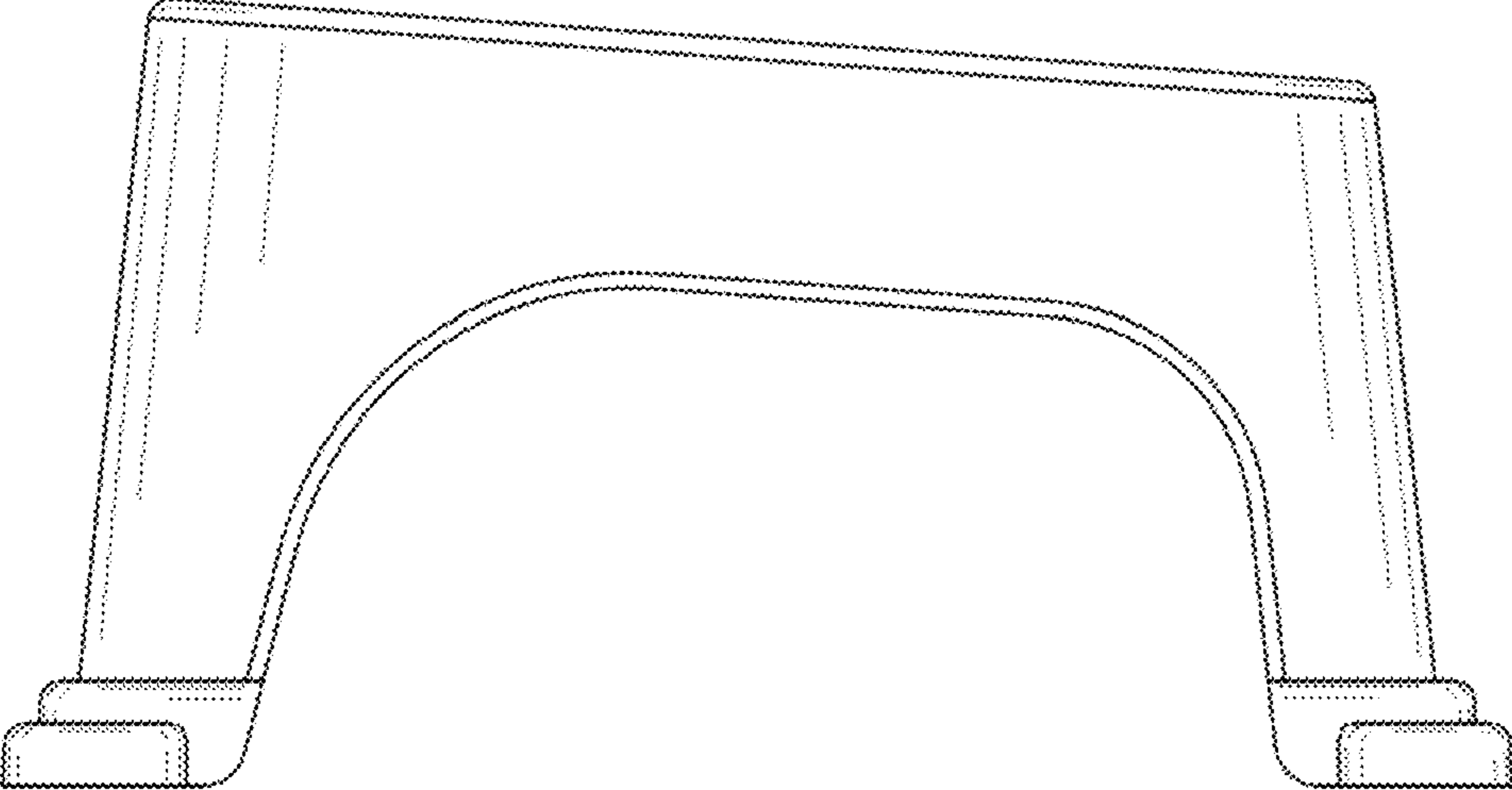

FIG.1

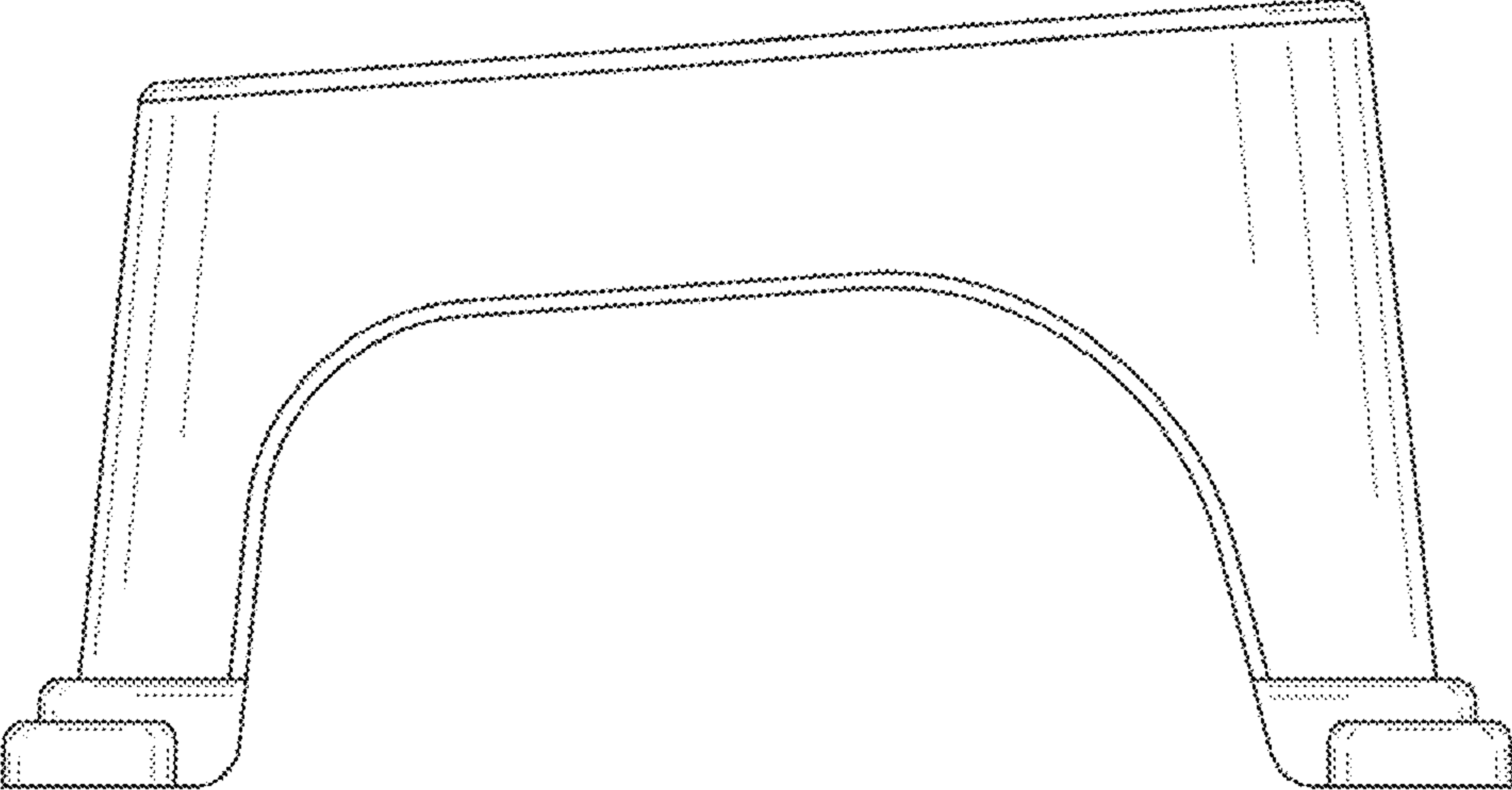

FIG.2

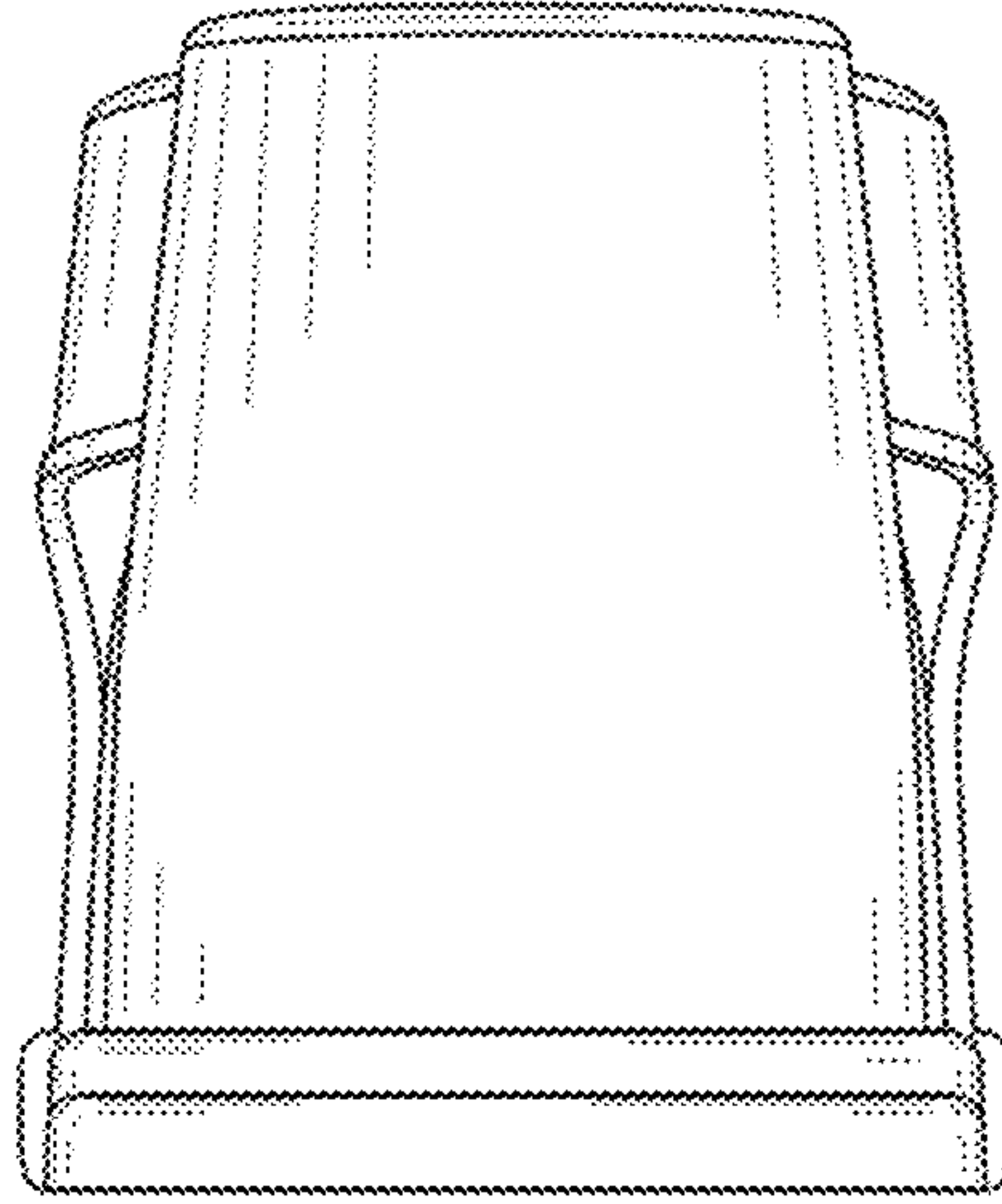

FIG.3

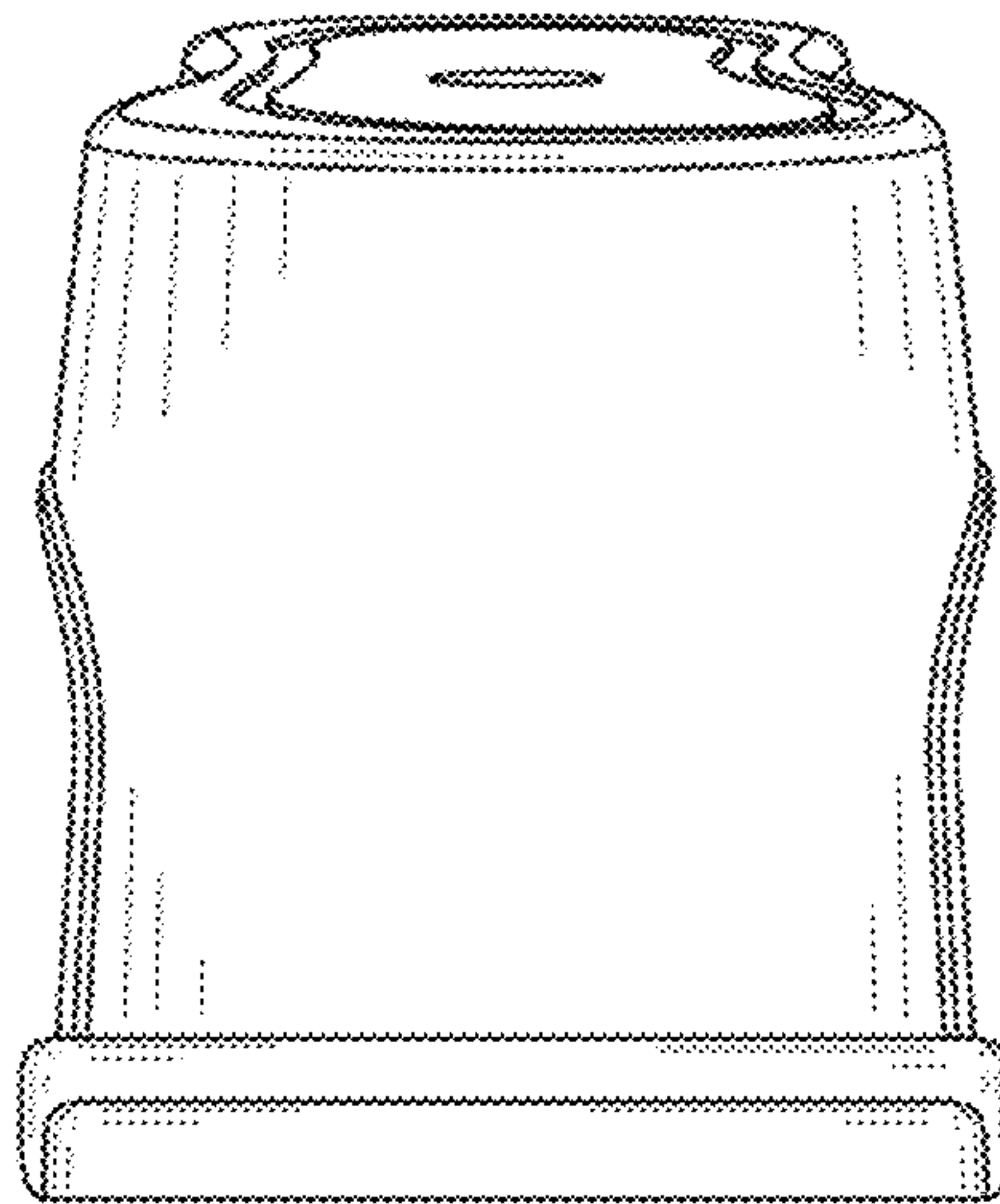

FIG.4

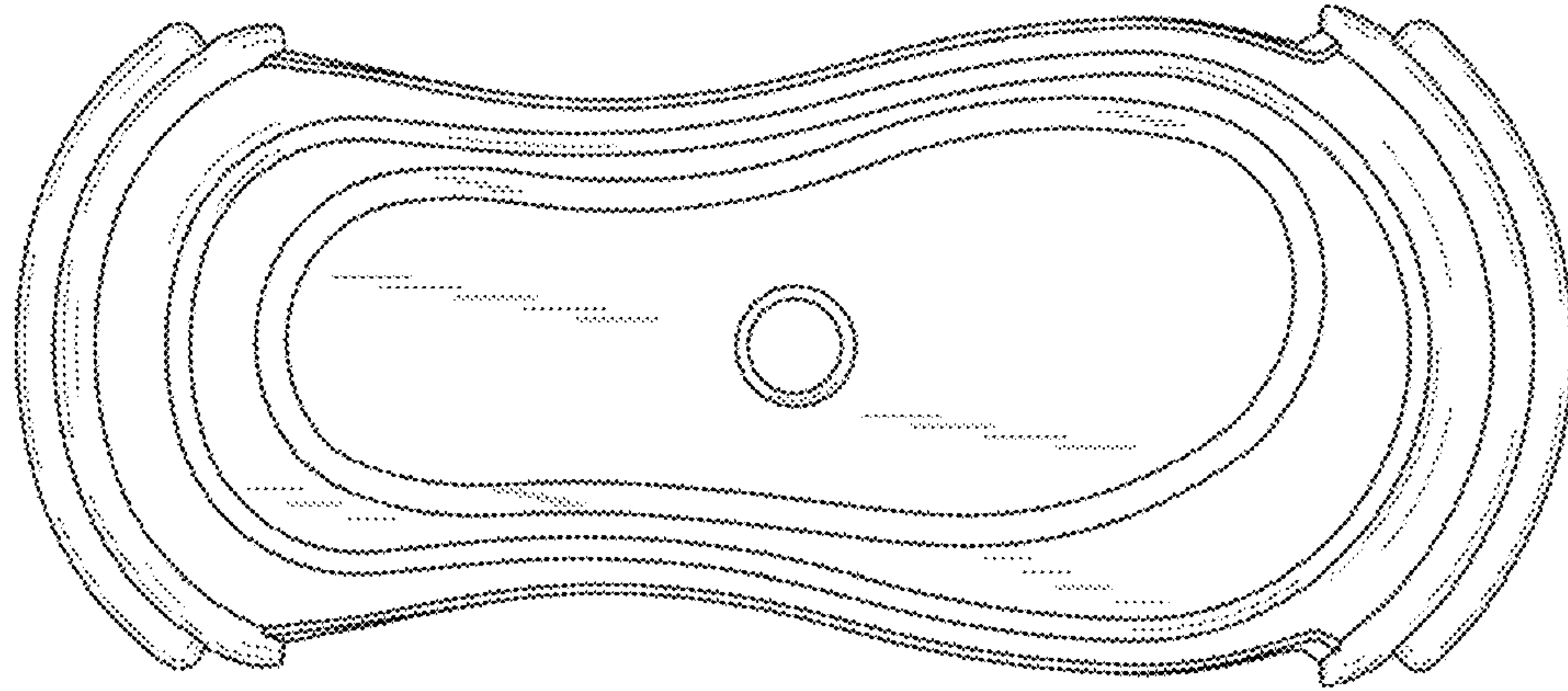

FIG. 5

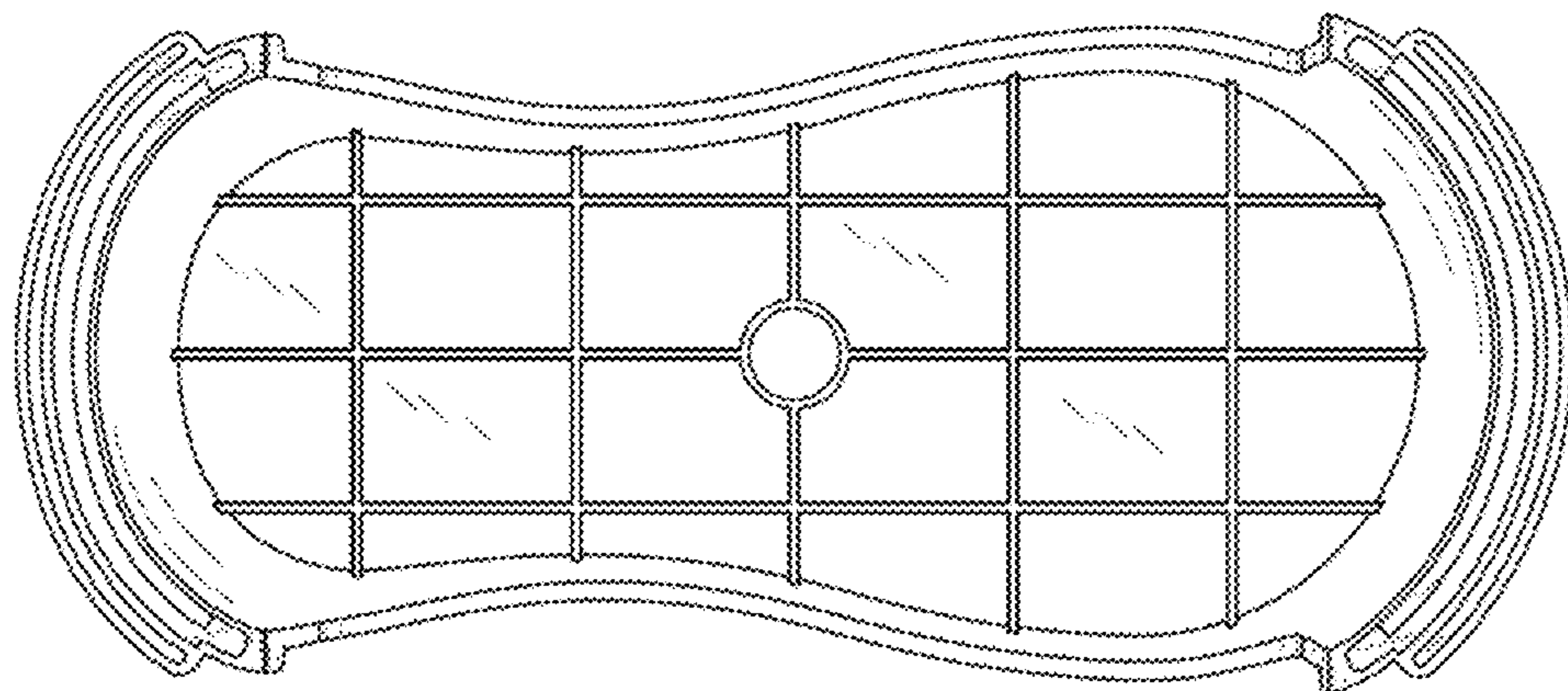

FIG. 6

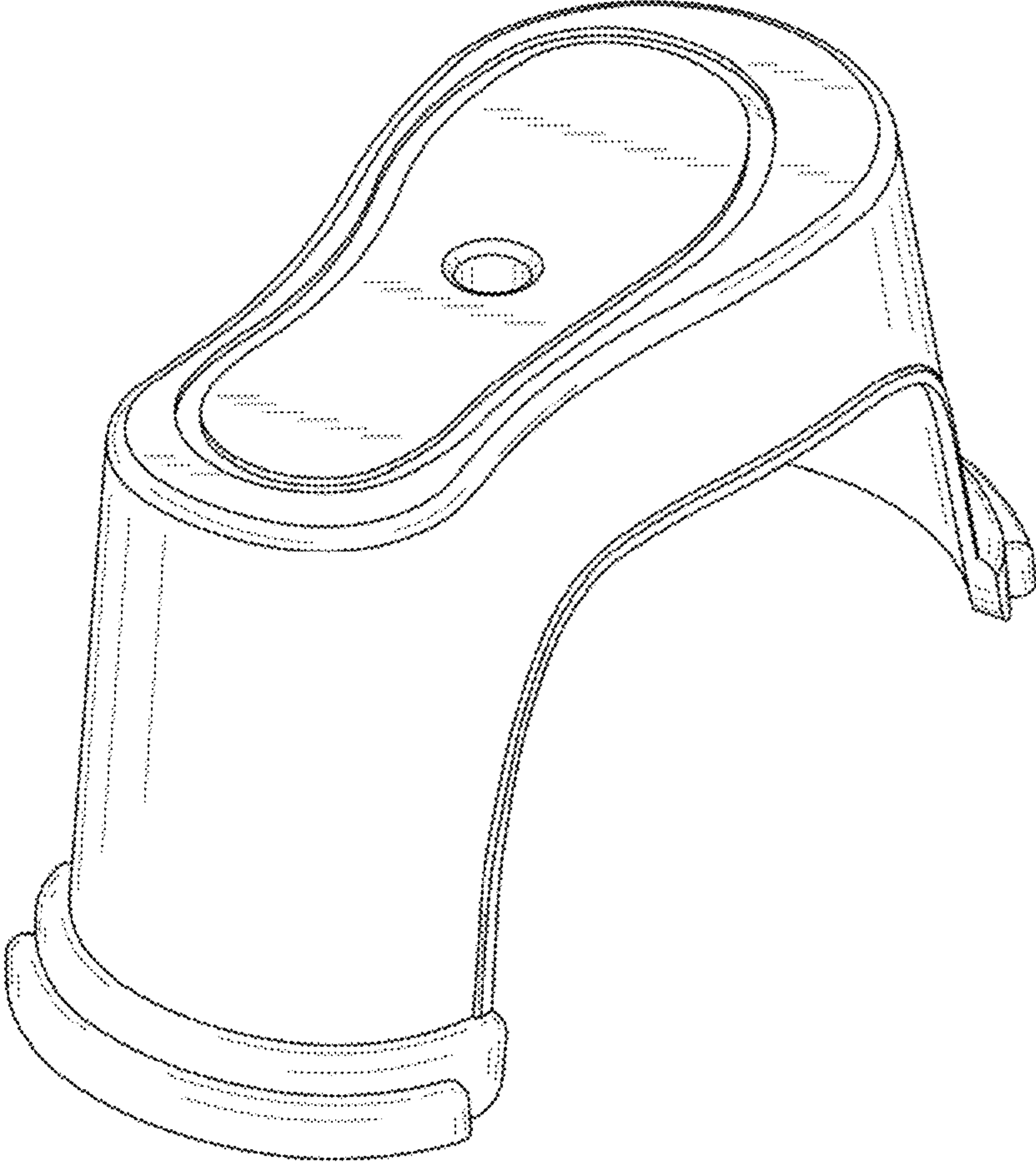

FIG. 7

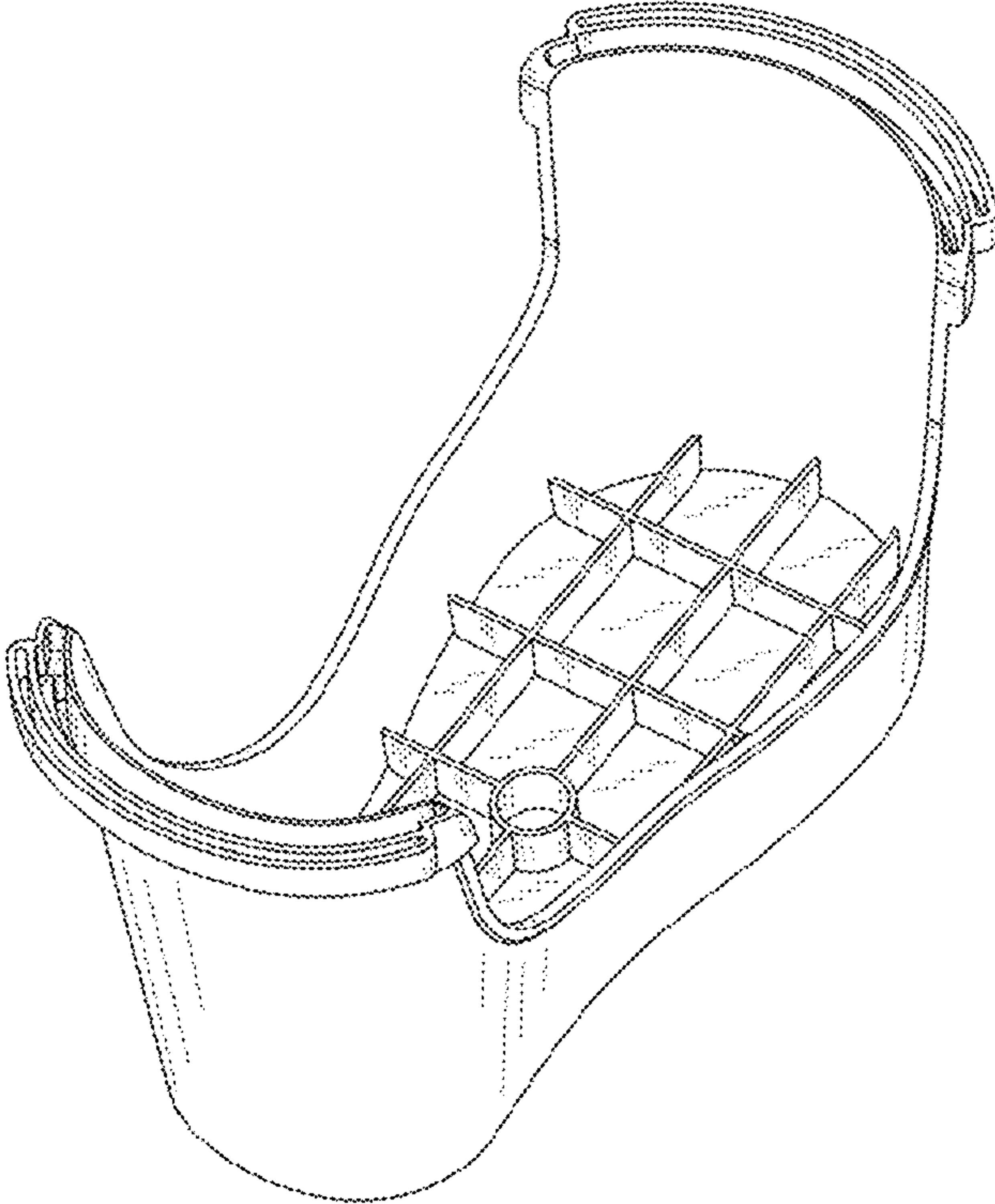

FIG.8